



FontanaArte

MILANO 1932

# THALEA

---

Paolo Rizzatto | Francesco Librizzi

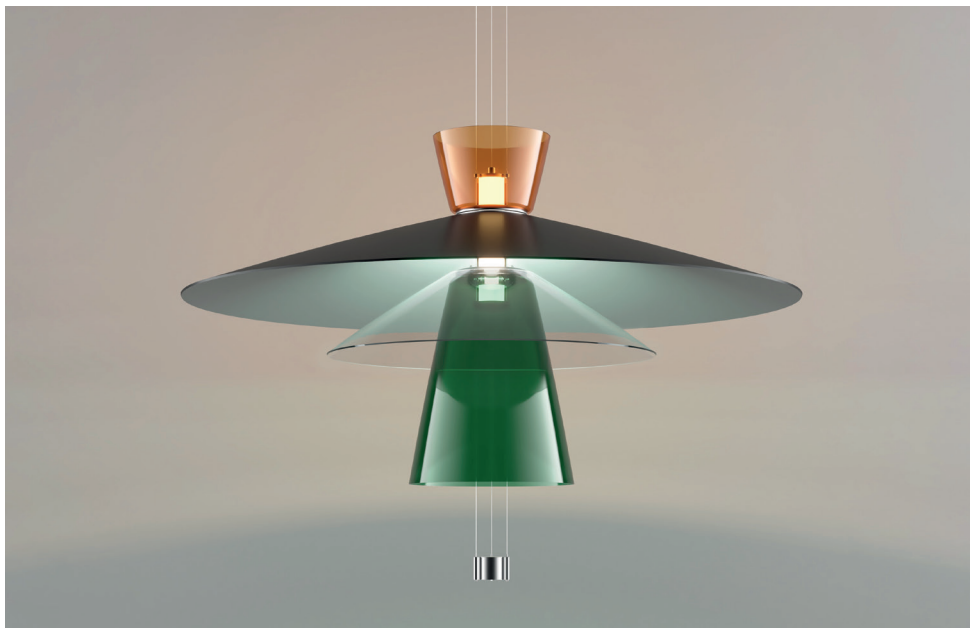

**Dalla passione per la luce e il colore di Paolo Rizzatto e Francesco Librizzi nasce il progetto Thalea.**

**Una serie di paralumi in vetro borosilicato colorato** e alluminio che, si possono comporre in configurazioni molteplici, ispirate alle proporzioni dei capolavori dell'arte rinascimentale italiana.

I paralumi, di diversa dimensione e ampiezza, sono di forma conica con una leggera bombatura che ne addolcisce la silhouette.

**La gamma cromatica** è ampia e spazia dai toni caldi ai freddi, combinati nelle diverse composizioni in armonia o a contrasto.

**Due le sorgenti luminose**, un LED dimmerabile che diffonde la luce nell'ambientale attraverso i vetri colorati e uno spot per illuminare direttamente le superfici.

**Thalea richiama lo spirito senza tempo**, in equilibrio tra arte e industria che ispira da sempre la produzione contemporanea di FontanaArte.

**Una lampada componibile che dà spazio ai sogni e alle necessità di chi la sceglie.**

**The Thalea project comes from the passion for light and colour of Paolo Rizzatto and Francesco Librizzi.**

**A series of lampshades in coloured borosilicate glass** and aluminum that, can be composed in multiple configurations, inspired by the proportions of masterpieces of Italian Renaissance art.

The lampshades vary in size and width and are conical in shape with a slight curvature that softens the silhouette.

**The colour palette** is wide and ranges from warm to cool tones, combined in different compositions in harmony or contrast.

**Two light sources**, dimmable LED that diffuses ambient light through the coloured glass and a spot light to illuminate the surfaces directly.

**Thalea recalls the timeless spirit** balanced between art and industry that has always inspired FontanaArte's contemporary production.

**A modular lamp that shapes the dreams of those who choose and compose it.**



**COMPOSIZIONE / COMPOSITION**

THR44841E210NB + THM44842E200AL + THV448410150VE + THV448430150BL + THV448420150TR + THS44841E200AL

**THR44841E210NB**

Rosone / Ceiling

● nero / black

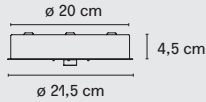

**THM44841E200AL**

con 1 ghiera di fissaggio /  
with 1 fixing ring

max 2 accessori /  
2 accessories max

LED 20W  
(2700K, CRI >90, 2400Lm)  
dimmerabile / dimmable DALI

● alluminio / aluminum

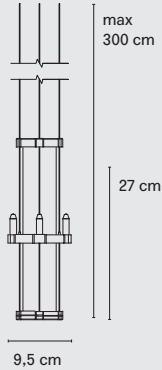

**THM44842E200AL**

con 2 ghiera di fissaggio /  
with 2 fixing rings

max 4 accessori /  
4 accessories max

LED 20W  
(2700K, CRI >90, 2400Lm)  
dimmerabile / dimmable DALI

● alluminio / aluminum

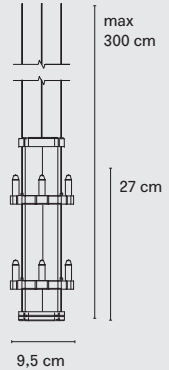

**THV448410150..**

Diffusore in vetro  
Glass diffuser



**THV448420150..**

Diffusore in vetro  
Glass diffuser

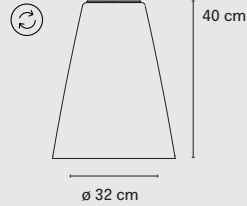

**THV448430150..**

Diffusore in vetro  
Glass diffuser

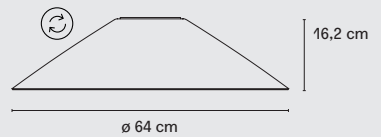

● AM (ambra / amber)

● RO (rosso / red)

● TR (trasparente / transparent)

● VE (verde / green)

● BL (blu / blue)

**THP4484200NEBI**

Paralume in metallo  
Metal diffuser

● nero, bianco / black, white

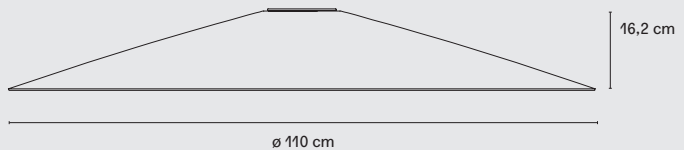

**THS44841E200AL**

Spot  
Spot

LED 8W  
(2700K, CRI 90, 1000Lm)  
dimmerabile / dimmable DALI

● alluminio / aluminum



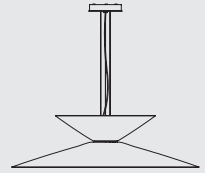
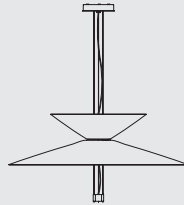
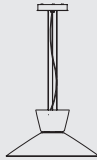
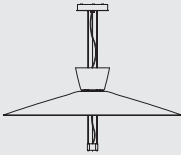
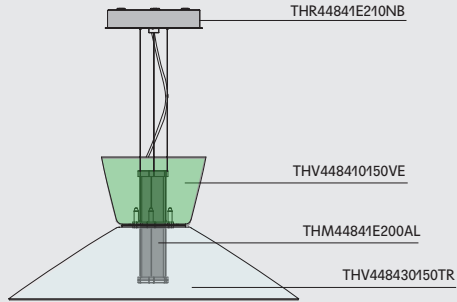

**THR44841E210NB**

rosone / ceiling

+

**THV448410150..**

diffusore in vetro / glass diffuser  
d.23 cm



+

**THP4484200BINE**

diffusore in metallo / metal diffuser

+

**THM44841E200AL**

corpo luce lineare / linear light body

+

**THS44841E200AL**

spot

**THR44841E210NB**

rosone / ceiling

+

**THV448410150..**

diffusore in vetro / glass diffuser  
d.23



+

**THV448430150..**

diffusore in vetro / glass diffuser  
d.64 cm



+

**THM44841E200AL**

corpo luce lineare / linear light body

**THR44841E210NB**

rosone / ceiling

+

**THV448430150..**

diffusore in vetro / glass diffuser  
d.64



+

**THP4484200BINE**

diffusore in metallo / metal diffuser

+

**THM44841E200AL**

corpo luce lineare / linear light body

+

**THS44841E200AL**

spot

**THR44841E210NB**

rosone / ceiling

+

**THV448430150..**

diffusore in vetro / glass diffuser  
d.64



+

**THP4484200NEBI**

diffusore in metallo / metal diffuser

+

**THM44841E200AL**

corpo luce lineare / linear light body



**THR44841E210NB**

rosone / ceiling

+

**THV448410150..**

diffusore in vetro / glass diffuser  
d.23



+

**THV448420150..**

diffusore in vetro / glass di user  
d.32 cm



+

**THM44841E200AL**

corpo luce lineare / linear light body

+

**THS44841E200AL**

spot

**THR44841E210NB**

rosone / ceiling

+

**THV448410150..**

diffusore in vetro / glass diffuser  
d.23 cm



+

**THV448420150..**

diffusore in vetro / glass di user  
d.32 cm



+

**THM44841E200AL**

corpo luce lineare / linear light body

**THR44841E210NB**

rosone / ceiling

+

**2 x THV448410150..**

diffusore in vetro / glass diffuser  
d.23



+

**THM44841E200AL**

corpo luce lineare / linear light body

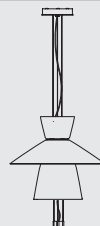
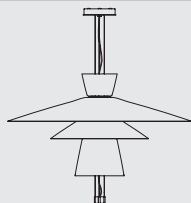
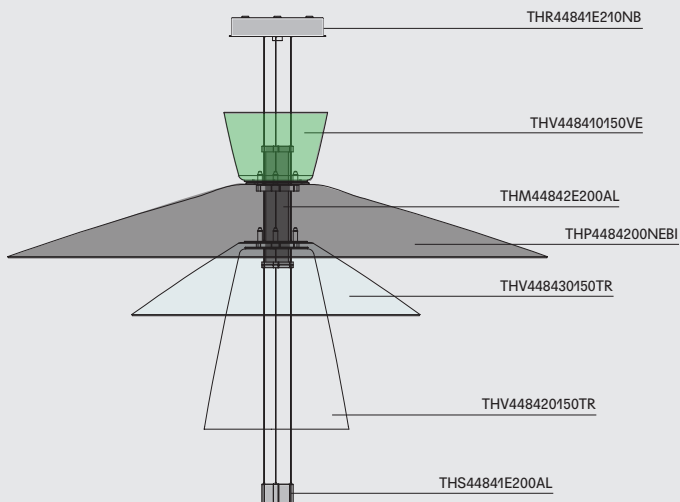

**THR44841E210NB**

rosone / *ceiling*

+

**THV448410150..**

diffusore in vetro / *glass diffuser d.23 cm*



+

**THP4484200BINE**

diffusore in metallo / *metal diffuser*

+

**THV448430150..**

diffusore in vetro / *glass diffuser d.64 cm*



+

**THV448420150..**

diffusore in vetro / *glass di user d.32 cm*



+

**THM44842E200AL**

corpo luce lineare / *linear light body*

+

**THS44841E200AL**

spot

**THR44841E210NB**

rosone / *ceiling*

+

**THV448410150..**

diffusore in vetro / *glass diffuser d.23*



+

**THV448420150..**

diffusore in vetro / *glass di user d.32 cm*



+

**THV448430150..**

diffusore in vetro / *glass di user d.64*



+

**THM44842E200AL**

corpo luce lineare / *linear light body*

+

**THS44841E200AL**

spot



**COMPOSIZIONE / COMPOSITION**

THR44841E210NB + THM44841E200AL + THV448430150RO + THP4484200NEBI



[fontanaarte.com](http://fontanaarte.com)