

*Lookup*



30 years of production, research and development dedicated to our magnificent project the evolution of light  
30 anni di produzione, ricerca e sviluppo dedicati al nostro magnifico progetto l'evoluzione della luce  
30 ans de production, recherche et développement dédié à notre magnifique projet, l'évolution de la lumière  
30 años de producción, investigación y desarrollo dedicado a nuestro magnífico proyecto, la evolución de la luz  
30 Jahre Herstellung, Forschung und Entwicklung unseres großartigen Projektes: die Evolution des Lichts  
30 лет производства, исследования и развития, посвящённые нашему великоллепному замыслу: эволюция света





Lookup

# INDEX

## GENERAL INDEX

4-5	Illustrated Index (Suspension, Wall, Floor, Recessed, Table Lamp)
7	Who we are
9	Mission
11	Quality
13	Company History
14	Vario Lumen™
15	Vario Kelvin™
17	Magnetic Cover
18	Colour Selection
19	Special Colour on request
20-21	Legenda (How to read the catalogue)
22-25	Legenda (Possible applications - Symbols of the technical details)
27	Suspension
115	Wall
189	Floor
215	Recessed
233	Table Lamp
250-251	Analytical products and accessories index
252	Connection scheme
253-255	General sales conditions

## PRODUCT INDEX



Product	Page	Section
Adalпина	89	Suspension
Atba	117	Wall
Amadeus	191	Floor
Aquadro i-L	29	Suspension
Arrondo	73	Suspension
Birba	207	Floor
Bolerino	111	Suspension
Bombei M	181	Wall
Calea	129	Wall
Circo	93	Suspension
Demi Led	219	Recessed
Dosi	153	Wall
Dudu	149	Wall
Eliot i-L	35	Suspension
Ester	145	Wall
Faces M	125	Wall
Furba	211	Floor
Gina	157	Wall

Product	Page	Section
Hollow	229	Recessed
Jeè i-L	47	Suspension
Leila	165	Wall
Libra	101	Suspension
Lina	235	Table Lamp
Loft	57	Suspension
Maciste	61	Suspension
Mali S-AM	161	Wall
Nero	227	Recessed
Nori i-L	41	Suspension
Norton	169	Wall
Olimpia	97	Suspension
Opalia i-L	105	Suspension
Pia	173	Wall
Pla	185	Wall
Rio	225	Recessed
Round	65	Suspension
Round IP55	69	Suspension

Product	Page	Section
Sei	221	Recessed
Silence	195	Floor
Sphere	243	Table Lamp
Squadra	239	Table Lamp
Squak	53	Suspension
Stilo	247	Table Lamp
Talè M - Talè	139	Wall
Tink	121	Wall
Trem	177	Wall
Tubi CM-S	81	Suspension
Ufo	77	Suspension
Uno	223	Recessed
Utile	199	Floor
Zero	203	Floor
Zoe M - Zoe	133	Wall

# INDEX

## ILLUSTRATED INDEX

### SUSPENSION



Aquadro i-L  
p. 29



Eliot i-L  
p. 35



Nori i-L  
p. 41



Jeè i-L  
p. 47



Squak  
p. 53



Loft  
p. 57



Maciste  
p. 61



Round  
p. 65



Round IP55  
p. 69



Arrondo  
p. 73



Ufo  
p. 77



Tubi CM-S  
p. 81



Adalpina  
p. 89



Circo  
p. 93



Olimpia  
p. 97



Libra  
p. 101



Opalia i-L  
p. 105



Bolerino  
p. 111

### WALL



Alba  
p. 117



Tink  
p. 121



Faces M  
p. 125



Calea  
p. 129



Zoe M - Zoe  
p. 133



Talè M - Talè  
p. 139



Ester  
p. 145



Dudu  
p. 149



Dosi  
p. 153



Gina  
p. 157



Mali S-AM  
p. 161



Leila  
p. 165



Norton  
p. 169



Pia  
p. 173



Trem  
p. 177



Bombei M  
p. 181



Pla  
p. 185

# INDEX

## ILLUSTRATED INDEX

### FLOOR



Amadeus  
p. 191



Silence  
p. 195



Utile  
p. 199



Zero  
p. 203



Birba  
p. 207



Furba  
p. 211

### RECESSED



Demi Led  
p. 219



Sei  
p. 221



Uno  
p. 223



Rio  
p. 225



Nero  
p. 227



Hollow  
p. 229

### TABLE LAMP



Lina  
p. 235



Squadra  
p. 239



Sphere  
p. 243



Stilo  
p. 247



Una donna è il cerchio che si chiude: sua è la capacità di creare,  
nutrire e trasformare  
*(Diane Mariechild)*



Tutti sanno che una cosa è impossibile da realizzare,  
finché arriva uno sprovveduto che non lo sa e la inventa.  
*(Albert Einstein)*



Lo scienziato descrive ciò che esiste, l'ingegnere crea  
ciò che non era mai stato.  
*(Theodore von Kármán)*



# WHO WE ARE

**GRUPPO RAINA** is the brand that brings together under the same name:

**IDEALLUX®** historical production specialized in the production and sale of fittings for industry and tertiary. **COLOMBO** brand specific for street and outdoor fixtures. **LOOKUP** with its wide and new range of decorative lighting fittings.



**IDEALLUX®**

**COLOMBO**

*Lookup*

$\frac{6}{7}$

## IT

### **CHI SIAMO**

Il **Gruppo Raina** è il brand che raggruppa sotto lo stesso nome i marchi: **IDEALLUX®** produzione storica specializzata nella realizzazione e vendita di apparecchi destinati ai settori dell'industria e del terziario. **COLOMBO** marchio specifico per gli apparecchi stradali, arredo urbano e da esterno. **LOOKUP** con la sua nuova e ampia gamma di apparecchi decorativi e architettonici.

## FR

### **QUI SOMMES-NOUS**

**Gruppo Raina** est le brand qui rassemble sous le même nom les marques **IDEALLUX®** - Appareilles pour l'industrie et le tertiaire, **LOOKUP** - Appareilles décoratifs et **COLOMBO** - Gamme routier et d'extérieur.

## ES

### **QUIEN SOMOS**

**Gruppo Raina** es la marca que reúne bajo el mismo nombre a las marcas **IDEALLUX®** -Luminarias para la industria y servicios, **LOOKUP** - Luminarias decorativas y **COLOMBO** - Luminarias viales y de exterior.

## DE

### **WER WIR SIND**

**Gruppo Raina** ist das Brandmal, das unter der gleichen Name die Marke gruppiert: **IDEALLUX®** Historische Produktion, spezialisiert auf den Bau und Verkauf von Leuchten für den Industrie- und Dienstleistungssektor. **COLOMBO** spezifische Marke für Straßen- und Outdoor-Leuchten. **LOOKUP** neue und breite Linie von dekorativen und architektonischen Leuchten.

## RU

### **О НАС**

**GRUPPO RAINA** является брендом, включающим в себя следующие марки: **IDEALLUX®** является знаменитым производством, специализирующемся на изготовлении и продаже осветительных приборов, предназначенных для промышленного сектора и сферы услуг.

**COLOMBO** – это марка, разрабатывающая уличные осветительные приборы и уличное оборудование.

**LOOKUP** представляет собой новую широкую гамму декоративных и архитектурных осветительных приборов.



# MISSION

The group's mission is the design and production of lighting systems characterized from high technology and very good performance, totally made at the Cilavegna plant in the Province of Pavia and certified 100% Made in Italy. The Gruppo Raina obtained the Certification ISO 9001: 2008 and the 100% Made in Italy Certification issued by the Institute for the Protection of Italian Manufacturers. The numbers of the group can explain the capacity of it: 12.000 square meters of production plant, 7.000 sqm of warehouse, 100 resources employed and more than 3.800 active customers.



## IT

### MISSION

Il gruppo ha come mission la progettazione e la produzione di sistemi di illuminazione, caratterizzati da un'elevata tecnologia e da un ottimo rendimento, totalmente realizzati nello stabilimento di Cilavegna, in Provincia di Pavia e certificati 100% Made in Italy. Gruppo Raina vanta tra le certificazioni ottenute la certificazione ISO 9001:2008 e la certificazione 100% Made in Italy rilasciata dall'Istituto Per la Tutela dei Produttori Italiani. I numeri del gruppo riassumono le capacità dello stesso, con i suoi 12.000 mq di stabilimento produttivo, 7.000 mq di magazzino, 100 risorse impiegate e oltre 3.800 clienti attivi.

## FR

### MISSION

Le groupe a comme mission le projet et la production de systèmes d'éclairage, réalisé dans l'usine de Cilavegna, dans la province de Pavie et certification 100% made in Italy. Certification ISO 9001:2008 Certification 100% Made in Italy relâché par l'institut pour la Tutelle des Producteur Italiens. LE NOMBRES: 12.000 mq d'usine productive. 7.000 mq de magasin. 100 ressources employées. 3.800 clients actifs.

## ES

### MISSION

El grupo tiene como misión el diseño y producción de sistemas de iluminación, fabricados en la p CERTIFICACIONES  
La certificación ISO 9001: 2008 Certificación 100% Made in Italy emitida por el instituto para la Protección de Fabricantes Italianos lanta de Cilavegna, en la Provincia de Pavia y certificados 100% Made in Italy.  
LOS NUMEROS: 12.000 mq de planta de producción, 7.000 mq de almacén, 100 recursos utilizados, 3.800 clientes activos.

## DE

### MISSION

Die Gruppe hat sich zum Ziel gesetzt, Beleuchtungssysteme zu entwerfen und zu produzieren, die sich durch Hochtechnologie und hervorragende Leistung auszeichnen. Sie werden vollständig im Werk von Cilavegna in der Provinz Pavia hergestellt und sind zu 100% Made in Italy zertifiziert.  
Die Gruppo Raina hat unter den Zertifizierungen die ISO 9001: 2008-Zertifizierung und die 100% Made in Italy-Zertifizierung des Instituts zum Schutz italienischer Hersteller erhalten.  
Die Zahlen der Gruppe fassen die Kapazität derselben mit 12.000 Quadratmetern Produktionsanlage, 7.000 Quadratmetern Lagerhalle, 100 Mitarbeitern und mehr als 3.800 aktiven Kunden zusammen.

## RU

### МИССИЯ

Миссия группы заключается в проектировании и производстве осветительных систем, характеризующихся высокими технологиями и отличной эффективностью. Они производятся исключительно на заводе в городе Чилавенья в провинции Павия и имеют сертификаты 100% Сделано в Италии (100% Made in Italy). Группа Raina гордится наличием сертификата ISO 9001:2008 и сертификата 100% Сделано в Италии (100% Made in Italy), который был выдан Институтом по защите прав итальянских производителей. Приведённые ниже цифры показывают возможности группы: 12.000 м2 производственного предприятия, 7.000 м2 складских помещений, 100 человек рабочего персонала и более 3.800 активных клиентов.



# QUALITY

With a view to customer satisfaction and service optimization, Ideallux® has put in place quality control processes with the aim of limiting defectiveness, which has been less than 1% (ISO statistical data of the last three years).

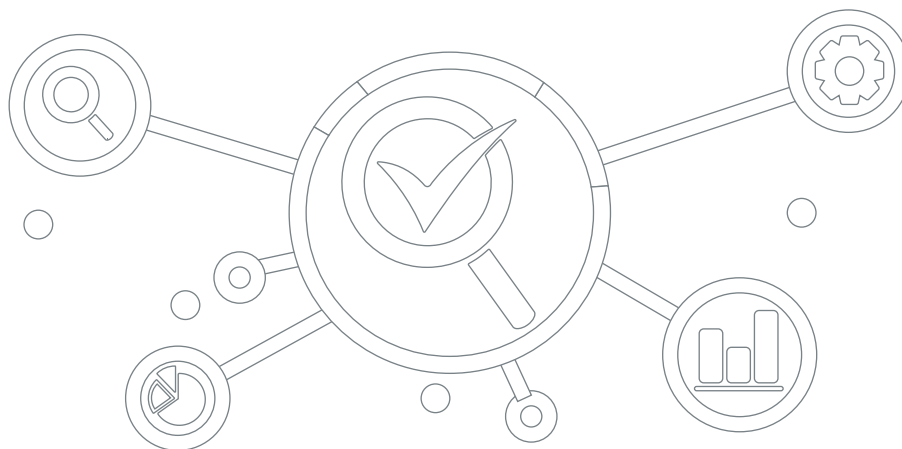

## IT

### **QUALITÀ**

Nell'ottica della soddisfazione del cliente e dell'ottimizzazione del servizio, Ideallux® ha messo in atto processi di controllo qualità con l'obiettivo di limitare la difettosità, che si è attestata ad una percentuale inferiore all'1% (dato statistico ISO degli ultimi tre anni).

## FR

### **QUALITÉ**

Dans l'optique de la satisfaction du client et de l'optimisation du service, Ideallux® a mis en cours un procès de contrôle qualité avec l'objectif de limiter la déféctuosité qui sont attestés à une pourcentage inférieure au 1 % (info statistique ISO des derniers trois ans).

## ES

### **CALIDAD**

Con miras a la satisfacción del cliente y la optimización del servicio, Ideallux® ha puesto en marcha procesos de control de calidad con el objetivo de limitar la defectuosidad, que ha alcanzado un porcentaje inferior al 1% (datos estadísticos ISO de los últimos tres años).

## DE

### **QUALITÄT**

Im Hinblick auf Kundenzufriedenheit und Serviceoptimierung hat Ideallux® Qualitätskontrollprozesse eingeführt, um den Fehler zu begrenzen, der einen Prozentsatz von weniger als 1% erreicht hat (ISO-Statistikdaten der letzten drei Jahre).

## RU

### **КАЧЕСТВО**

С учётом удовлетворения запросов клиентов и оптимизации обслуживания, Идеаллюкс внедрила процесс управления качеством с целью уменьшения дефектов производства, которые не превышают 1% (данные статистики ISO за последние три года).



# COMPANY HISTORY

**1987** › Ideallux® was founded in 1987 by the will of Claudio Raina. Born as an artisan company producing lighting equipment, to become in a few years one of the most important producers in the lighting sector.

**2011** › In 2011 the transition from traditional sources takes place, while LED technology is being developed. Ideallux® launches a catalog exclusively dedicated to LED lighting fixtures, alongside the well-established fluorescence product catalogue.

**2017** › 2017 marked the milestone of 30 years of activity. The Fuorisalone 2017 - Via Tortona - Milan was the perfect location to celebrate this important stage, presenting the Ideallux® products with a new look.

**2018** › In 2018 on the occasion of Light + Building in Frankfurt, the most prestigious lighting fair on the international scene, Ideallux® presents the new Gruppo Raina to the lighting world. Gruppo Raina is the brand that brings together the Ideallux®, Lookup and Colombo brands under the same name.



## IT

### LA STORIA

Ideallux® viene fondata nel 1987 per volontà di Claudio Raina. Nasce come azienda artigiana di produzione di apparecchi di illuminazione, per divenire in pochi anni un'importante realtà industriale del settore di illuminazione. Nel 2011 avviene il passaggio dalle fonti tradizionali alle nuove tecnologie LED. Ideallux® lancia un catalogo dedicato esclusivamente ad apparecchi di illuminazione LED, affiancandolo all'ormai consolidato catalogo di prodotti fluorescenza. Il 2017 ha segnato il traguardo dei 30 ANNI di attività. Il Fuorisalone 2017 - Via Tortona - Milano è stata la location perfetta per festeggiare questa importantissima tappa, presentando i prodotti Ideallux® con una nuova veste. Nel 2018, in occasione di Light+Building, la più prestigiosa fiera dell'illuminazione nel panorama internazionale, Ideallux® presenta al mondo del lighting il nuovo Gruppo Raina. Gruppo Raina è il brand che raggruppa sotto lo stesso nome i marchi Ideallux®, Lookup e Colombo.

## FR

### HISTOIRE

Ideallux® est fondé en 1987 pour volonté de Claudio Raina. Né comme usine artisanale de production des appareils d'éclairage, pour devenir après quelques années une importante réalité industrielle du secteur d'éclairage. En 2011 arrive le passage des sources traditionnelles aux nouvelles technologies LED. Ideallux® lance un catalogue exclusivement dédié aux appareils d'éclairage LED, a côté du consolidé catalogue produits fluorescence. Le 2017 a marqué la ligne d'arrivée des 30 ANS d'activité. Le Fuorisalone 2017 près de Via Tortona en Milan a été en endroit parfaite pour célébrer cette importante étape en présentant les produits Ideallux® avec un nouveau vêtement. En 2018, pendant la foire Light+Building, la plus prestigieuse concernant l'éclairage dans le panorama international, Ideallux® présente au monde du Lighting le nouveau Gruppo Raina. Groupe Raina est le brand qui groupe sous le même nom les marques Ideallux®, Lookup et Colombo.

## ES

### HISTORIA

Ideallux® fue fundada en 1987 por voluntad de Claudio Raina. Nace como una empresa artesanal que produce aparatos de iluminación, para convertirse en pocos años en una realidad industrial importante en el sector de la iluminación. En 2011 se lleva a cabo la transición de las fuentes tradicionales de iluminación a las nuevas tecnologías LED. Ideallux® lanza un catálogo dedicado exclusivamente a los aparatos de iluminación LED, uniéndolo con el ya bien consolidado catálogo de productos de fluorescencia. 2017 marcó el hito de 30 años de actividad. El Fuorisalone 2017 - Via Tortona - Milán fue el lugar perfecto para celebrar esta importantísima etapa, presentando los productos Ideallux® con un nuevo look. En 2018, con motivo de Light + Building, la feria de iluminación más prestigiosa de la escena internacional, Ideallux® presenta el nuevo Gruppo Raina al mundo de la iluminación. Gruppo Raina es la marca que agrupa a las marcas Ideallux®, Lookup y Colombo bajo el mismo nombre.

## DE

### DIE GESCHICHTE

Geboren als handwerkliches Unternehmen, das Beleuchtungsgeräte herstellt, um in wenigen Jahren eine wichtige industrielle Realität in der Beleuchtungsbranche zu werden. Im Jahr 2011 findet der Übergang von traditionellen Quellen zu neuen LED-Technologien statt. Neben dem bekannten Fluoreszenz-Produktkatalog führt Ideallux® einen Katalog ein, der sich ausschließlich mit LED-Beleuchtungsgeräten befasst. 2017 war der Meilenstein von 30 Jahren Aktivität. Die Fuorisalone 2017 - Via Tortona - Mailand war der perfekte Ort, um diese wichtige Etappe zu feiern und die Ideallux® Produkte mit einem neuen Look zu präsentieren. Im Jahr 2018 präsentiert Ideallux® anlässlich der Light + Building, der prestigeträchtigsten Lichtmesse der internationalen Szene, die neue Raina Group der Lichtwelt. Gruppo Raina ist die Marke, die die Marken Ideallux®, Lookup und Colombo unter demselben Namen vereint.

## RU

### ИСТОРИЯ

Идеаллюкс была основана в 1987 году Клаудио Райна. Она изначально являлась ремесленной мастерской по производству осветительного оборудования, которая вскоре переросла в важнейшую промышленную компанию в осветительной отрасли. В 2011 году произошёл переход от традиционных источников к новым технологиям СИД. Идеаллюкс выпускает каталог, посвящённый исключительно осветительному оборудованию СИД, который сосуществует с уже устоявшимся каталогом флуоресцентных продуктов. В 2017 году компания отметила 30 ЛЕТ успешной работы. Fuorisalone 2017 – Улица Tortona – Милан было идеальным местом для празднования этого важнейшего этапа и представления продуктов Идеаллюкс в новом обличье. В 2018 году по случаю Light+Building, самой престижной осветительной выставки на мировой арене, Идеаллюкс представила новую Группу Raina. Группа Raina является брендом, который объединяет под одним именем марки Ideallux®, Lookup и Colombo.



# VARIO LUMEN™

Notably the system Vario Lumen™ adopts a technology that allows to vary the power and therefore the quantity of lumen sent forth by the products of Gruppo Raina. This innovative system, allows the Electrical Distributors to optimize their warehouses and solve list of problems of installation plants for Installers Clients. With an only produced code, they could go up to a maximum of five levels of regulation of bright flow. With the technology Vario Lumen™, to choose the quality light that needs is economic and easy.



50%



75%



100%

## IT VARIO LUMEN™

Il sistema Vario Lumen™ adotta una tecnologia che permette di variare la potenza e quindi la quantità di lumen emessi dagli apparecchi di illuminazione del Gruppo Raina. Questo innovativo sistema, permette di ottimizzare i magazzini dei distributori di materiale elettrico e risolvere problematiche di impianto durante la fase di installazione ai clienti impiantisti. Con un unico codice prodotto, si possono raggiungere fino ad un massimo di cinque livelli di regolazione di flusso luminoso. Con la tecnologia Vario Lumen™, scegliere la luce che occorre è economico e facile.

## FR VARIO LUMEN™

Dans le spécifique le système Vario Lumen™ adopte une technologie qu'il permet de changer la puissance et ensuite la quantité de lumen émise par les appareils d'éclairage du Gruppo Raina. Ce système innovant permet d'optimiser les stocks des Distributeurs de matériel électrique et résoudre les problématiques d'installation pendant la phase d'installation aux clients installateurs. Avec un code produit unique, ils peuvent atteindre fin à un maximum de 5 (cinq) niveaux de régulation de flux lumineux. Avec la technologie Vario Lumen™, choisir la lumière qui faut est économique et facile.

## ES VARIO LUMEN™

Específicamente, el sistema Vario Lumen™ adopta una tecnología que permite variar la potencia y por lo tanto la cantidad de lúmenes emitidos por las luminarias de Gruppo Raina. Este sistema innovador, permite optimizar los almacenes de los distribuidores de equipos eléctricos y solucionar problemas durante la fase de instalación. Con un solo código producto, se puede conseguir un máximo de cinco niveles de regulación de flujo de luz. Con la tecnología Vario Lumen™, elegir la luz que necesita es fácil y barato.

## DE VARIO LUMEN™

Das Vario Lumen™-System verwendet eine Technologie, mit der man die Leistung und damit die Lumenmenge der Gruppo Raina ändern können. Dieses innovative System ermöglicht die Optimierung der Lagerhäuser der Verteiler von elektrischen Geräten und die Lösung von Anlagenproblemen während der Installationsphase für die Anlagenkunden. Mit einem einzigen Produktcode können bis zu fünf Stufen der Lichtflusssteuerung erreicht werden. Mit der Vario Lumen™-Technologie ist die Auswahl des gewünschten Lichts kostengünstig und einfach.

## RU VARIO LUMEN™

Система Vario Lumen™ применяет технологию, которая позволяет варьировать мощность и, следовательно, количество люмен, излучаемых осветительными приборами Группы Raina. Данная инновационная система позволяет оптимизировать складские помещения компаний по обьету электрооборудования и решить проблематику производственной линии для клиентов, специализирующихся на установке оборудования во время монтажа. С одним единственным кодом продукта можно достичь максимум пяти уровней рекулирования светового потока. С помощью технологии Vario Lumen™ выбрать необходимое освещение проще и менее затратно.

## VARIO LUMEN™ CERTIFICATION >





# VARIO KELVIN™



The innovative system Vario Kelvin™ of Gruppo Raina allows to vary the temperature of colour of the product through an integrated selector. The simplicity of the technology Vario Kelvin™ makes the accessible solution in economic way to the whole lighting sector contrarily to other more expensive and complex technologies. Vario Kelvin™ of Gruppo Raina allows with an only product code, to choose among three different temperatures of colour: for the residential technical applications or of the retail 2700K, 3350K, 4000K; for the industrial fittings 3000K, 4000K, 6000K.



2700 K



3350 K



4000 K

## IT

### VARIO KELVIN™

L'innovativo sistema Vario Kelvin™ del Gruppo Raina permette di variare la temperatura di colore degli apparecchi di illuminazione, mediante un selettore opportunamente integrato nel prodotto. La semplicità della tecnologia Vario Kelvin™ rende la soluzione accessibile in modo economico a tutta la filiera, contrariamente ad altre tecnologie più costose e complesse. Vario Kelvin™ del Gruppo Raina permette con un unico codice prodotto la scelta tra tre diverse temperature di colore: per le applicazioni tecniche residenziali o del retail 2700K, 3350K, 4000K; per gli impianti industriali 3000K, 4000K, 6000K.

## FR

### VARIO KELVIN™

Le système innovant Vario Kelvin™ du Gruppo Raina permet de changer la température de couleur des appareils d'éclairage, par moyen d'un sélecteur intégré opportunément dans le produit. La simplicité de la technologie Vario Kelvin™ rend la solution accessible de manière économique pour l'ensemble de la filière, contrairement aux autres technologies plus chères et complexes. Vario Kelvin™ du Gruppo Raina permet avec un code produit unique la choix entre trois différentes températures de couleur : pour les applications techniques Résidentielles ou pour la Distribution 2700K, 3350K, 4000K; pour les installations Industrielles 3000K, 4000K, 6000K.

## ES

### VARIO KELVIN™

El sistema innovador Vario Kelvin™ de Gruppo Raina permite variar la temperatura de color de las luminarias por medio de un selector oportunamente integrado en el producto. La facilidad de la tecnología Vario Kelvin™ hace que la solución sea económicamente accesible a toda la cadena de suministro, al contrario de otras tecnologías más caras y complejas. Vario Kelvin™ permite con un solo código producto la elección de tres diferentes temperaturas de color: para aplicaciones técnicas residenciales o de venta 2700K, 3350K, 4000K; para instalaciones industriales 3000K, 4000K, 6000K.

## DE

### VARIO KELVIN™

Mit dem innovativen Vario Kelvin™ System der Gruppo Raina ist es möglich, die Farbtemperatur der Beleuchtungskörper durch ein in das Produkt integrierte Wahlschalter zu ändern. Die Einfachheit der Vario Kelvin™-Technologie macht die Lösung im Gegensatz zu anderen teureren und komplexeren Technologien über die Lieferkette wirtschaftlich zugänglich. Vario Kelvin™ der Gruppo Raina ermöglicht die Wahl zwischen drei verschiedenen Farbtemperaturen mit einem einzigen Produktcode: für technische oder private Anwendungen im Einzelhandel 2700K, 3350K, 4000K; für industrielle Installationen 3000K, 4000K, 6000K.

## RU

### VARIO KELVIN™

Иновативная система Vario Kelvin™ группы Raina позволяет варьировать температуру цвета осветительных приборов посредством соответствующего встроенного переключателя. Простота технологии Vario Kelvin™ делает данное решение экономически выгодным для всей отрасли, в отличие от старых более дорогих и сложных технологий. Vario Kelvin™ группы Raina позволяет с помощью одного единственного кода продукта выбор между тремя различными температурами цвета: для технического и жилого применения, а также применения в розничной торговле. 2700K, 3350K, 4000K; для промышленных производственных линий 3000K, 4000K, 6000K.

## VARIO KELVIN™ CERTIFICATION >





# MAGNETIC COVER



DO YOU WANT TO CHANGE THE LOOK OF YOUR ROOM TODAY? ...

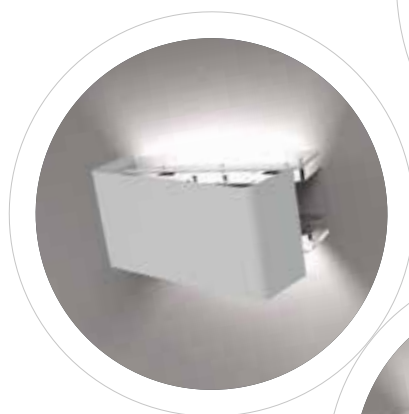

CHOOSE YOUR FAVOURITE COLOUR AND CHANGE THE COVER WHENEVER YOU WANT!



# COLOUR SELECTION



● SB | Silver Bombalai



● BL | Bronze Lario



● RR | Rust Rame



● BF | Beige Futuna



● GK | Gold Karkar



● BT | Blue Telica



● BLL | Black Lava



● WI | White Irazu



# SPECIAL COLOUR **On request**



● CO | Corten



● CH | Chrome



● OA | Ottone acidato



● OL | Ottone lucido



● OS | Ottone satinato



● RL | Rame lucido



● RS | Rame satinato



● PC | Primer Coating



# LEGENDA

## HOW TO READ THE CATALOGUE



**1** Fitting name

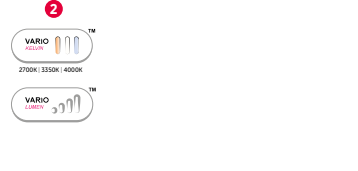

**2** Special features



**3** Product image



**4** Technical details

**5** Product description

**6** Product data

**7** Colour selection

**8** Beam angle

**9** Dimensional Drawing

**10** Accessoires

**LOFT VARIO LUMEN | VARIO KELVIN**

Code	Size	Vario Lumen	Watt	K	Beam angle	Driver Type	Driver no.	Colour
YLO20VKL	01	1050   1570   2090	10   15   20	Vario	D	ON/OFF	1	○

**LOFT**

Code	Size	Lumen	Watt	K	Beam angle	Driver Type	Driver no.	Colour
YLO36W	01	1720	16	W	D	ON/OFF	1	○
YLO23W	01	2440	23	W	D	ON/OFF	1	○
YLO35W	01	3370	30	W	D	ON/OFF	1	○
YLO39W	01	4150	39	W	D	ON/OFF	1	○

**LOFT COLOUR SELECTION**

**7**

- SB | Silver Bombatal
- BL | Bronze Lario
- RR | Rust Rame
- BF | Beige Futura
- WI | White Irazu
- GK | Gold Karkar
- BT | Blue Telca
- BLI | Black Lava

**LOFT BEAM ANGLE | DIMENSIONS**

**8**

Size	X (mm)	Z (mm)	Kg
01	440	470	3,8

**9**

**LOFT ACCESSORIES**

**10**

**INCLUDED**

- Rose ceiling for brick installation
- Ø Rose ceiling 120 mm | Height 25 mm
- Suspension cable length: 2 mt

	EN	IT	FR	ES	DE	RU
<b>1</b>	Fitting name	Denominazione articolo	Désignation de l'article	Designación del artículo	Artikelbezeichnung	Обозначение статьи
<b>2</b>	Special features	Configurazioni speciali	Configurations spéciales	Configuraciones especiales	Spezielle Konfigurationen	Специальные конфигурации
<b>3</b>	Product image	Immagine prodotto	Image du produit	Imagen del Producto	Produktbild	Изображение продукта
<b>4</b>	Technical details (See symbols Page 22-25)	Dati tecnici (Vedi simboli Pag. 22-25)	Caractéristiques Techniques (Voir symboles Page 22-25)	Datos técnicos (Ver símbolos Página 22-25)	Technische Daten (siehe Symbole Seite 22-25)	Технические данные (см. Символы на стр. 22-25)
<b>5</b>	Product description	Descrizione Prodotto	Description du produit	Descripción del producto	Produkt-Beschreibung	Описание продукта
<b>6</b>	Product data (See page 21)	Dati prodotto (Vedi pagina 21)	Fiche produit (Voir page 21)	Datos del producto (Ver página 21)	Produktdaten (siehe Seite 21)	Данные о продукте (см. Стр. 21)
<b>7</b>	Colour selection (See page 18)	Selezione colore (Vedi pagina 18)	Choix de couleur (Voir page 18)	Selección de color (Ver página 18)	Farbauswahl (siehe Seite 18)	выбор цвета (см. стр. 18)
<b>8</b>	Beam angle	Angolo del fascio luminoso	Angle du faisceau lumineux	Ángulo del haz de luz	Winkel des Lichtstrahls	угол светового луча
<b>9</b>	Dimensional Drawing And data	Disegno Dimensionale E dati	Dessin Dimensionnel et données	Dibujo dimensional y datos	Maßzeichnung und Daten	габаритный чертёж и данные
<b>10</b>	Accessories	Accessori	Accessoires	Accesorios	Zubehör	аксессуары

# LEGENDA

## 6 PRODUCT CHARACTERISTICS TABLE

	EN	IT	FR	ES	DE	RU
<b>A</b>	Code	Codice	Code	Código	Code	код
<b>B</b>	Size	Misura	Taille	Tamaño	Größe	Размер
<b>C</b>	It identifies the out flux based on the theoretical values related to optical and thermal performance	Indica il flusso emesso calcolato utilizzando i valori teorici relativi al rendimento ottico e termico.	Il indique le débit émis calculé à l'aide des valeurs théoriques relatives aux rendements optique et thermique.	Indica el flujo emitido calculado utilizando los valores teóricos relativos a la eficiencia óptica y térmica.	Es gibt den emittierten Fluss an, der anhand der theoretischen Werte für den optischen und thermischen Wirkungsgrad berechnet wurde.	Люмен – указывает поток излучения, рассчитываемый с использованием теоретических величин, относящихся к оптической и термической эффективности.
<b>D</b>	It is the total power absorbed by power grid from the lighting fitting. The value includes the power consumption of the power supply with a thermally stabilized device operating in an environment at 25 ° c.	È la potenza totale assorbita dalla rete elettrica dall'apparecchio di illuminazione. Il dato indicato è comprensivo dei consumi dell'alimentatore elettronico con apparecchio stabilizzato a regime termico operante in ambiente con temperatura pari a 25°C.	Puissance totale absorbée par le réseau électrique de l'appareil d'illumination. La donnée indiquée inclut la consommation de l'alimentateur électronique avec un appareil stabilisé à un régime thermique travaillant dans un milieu dont la température est égale à 25°C.	Es la potencia total absorbida por la red eléctrica del instrumento de iluminación. El dato indicado incluye el consumo del alimentador electrónico con equipo estabilizado a régimen térmico operante en un ambiente de temperatura igual a 25°C*	Es ist die gesamt Leistung, die das elektrische Netz von der Beleuchtungseinrichtung absorbiert. Das angegebene Datum beinhaltet den Verbrauch der elektronischen Stromversorgung, wobei sich die Geräte im thermischen Bereich stabilisiert haben und in einer Umgebung mit einer Temperatur von 25 ° c betrieben werden.	это полная потребляемая мощность электрической осветительным прибором. Указанная величина включает в себя потребление электронного блока питания, настроенного в термическом режиме при температуре 25°C.
<b>E</b>	It identifies the colour temperature of the leds expressed in kelvin degrees	Indica la temperatura di colore dei led espressa in gradi kelvin.	Indique la température de couleur des led exprimée en degrés kelvin.	Indica la temperatura de color de los leds expresada en grados kelvin.	Gibt die Farbtemperatur der Leds in Kelvin an.	указывает температуру света СИД, выраженную в градусах Кельвин.
<b>F</b>	Beam angle	Angolo del fascio luminoso	Angle du faisceau lumineux	Ángulo del haz de luz	Winkel des Lichtstrahls	угол светового луча
<b>G</b>	Driver type	Tipo di driver	Type de conducteur	Tipo de conductor	Treibertyp	Тип драйвера
<b>H</b>	Driver no.	Numero di driver	Nombre de conducteurs	Número de conductores	Treiberanzahl	Количество водителей
<b>I</b>	Colour	Colore	Couleur	Color	Farbe	цвет

## A ORDER CODE

It is the article code to be used to compose the order code.

È il codice articolo da usare per comporre il codice d'ordine.

Il s'agit du code d'article à utiliser pour composer le code de commande.

Este es el código de artículo que se utilizará para redactar el código de pedido.

Dies ist der Artikelcode, aus dem der Bestellungscode zusammengestellt wird.

Это код продукта, который используется для составления кода заказа.

Example code:

**YLO27W** **SB**









**A**

**I**

# LEGENDA









## POSSIBLE APPLICATIONS

APPLICAZIONI POSSIBILI | APPLICATIONS POSSIBLES | POSIBLES APLICACIONES | MÖGLICHE ANWENDUNGEN | ВОЗМОЖНЫЕ ПРИМЕНЕНИЯ

	EN	IT	FR
	Suspension	Sospensione	Suspension
	Wall mounted	Applique	Sur le mur
	Ceiling mounted	Plafone	Plafond
	Floor	Lampade da terra	Lampe au sol
	Recessed	Incassi	Encastré
	Adjustable Recessed	Incassi orientabili	Encastré orientables
	Ceiling mounted	Plafone	Plafond
	Table Lamp	Lampade da tavolo	Lampe de table

## SYMBOLS OF TECHNICAL DETAILS

SIMBOLI DEI DATI TECNICI | SYMBOLES DE DONNÉES TECHNIQUES | SÍMBOLOS DE DATOS TÉCNICOS | TECHNISCHE DATEN SYMBOLE  
ТЕХНИЧЕСКИЕ ОБОЗНАЧЕНИЯ

	EN	IT	FR
	LED is the acronym for light emission diode	LED è l'acronimo per LIGHT EMISSION DIODE.	LED est l'acronyme de LIGHT EMISSION DIODE
	Indicates that the product meets the requirements of the applicable EC Directives of the regulations in the EU	Indica che il prodotto è conforme ai requisiti di sicurezza richiesti dalle direttive e dalle normative della Comunità Europea.	Certifie que le produit est réalisé au sein de l'Union Européenne et dans le respect des normes de sécurités en vigueur.
	Isolation class 1	Classe di isolamento 1	Classe d'isolation 1
	Isolation class 2	Classe di isolamento 2	Classe d'isolation 2
	CRI (Colour Rendering index) indicates how natural the colours of the illuminated objects look	CRI (Colour Rendering index) Indica quanto naturali appaiano i colori degli oggetti da essa illuminati.	CRI (Colour Rendering index) Indique le rendement des couleurs des objets éclairés.
	Indicates the protection degree of the fixture against dust and water	Rappresenta il grado di protezione dell'apparecchio dalla polvere e dall'acqua.	Indique le degré de protection de l'appareil contre les poussières et l'eau
	Indicates the operating voltage of the fitting	Indica le tensioni operative dell'apparecchio.	Indique les tensions de travail de l'appareil
	Indicates the operating frequencies of the fitting	Indica le frequenze operative dell'apparecchio.	Indique les fréquences de travail de l'appareil



<b>ES</b>	<b>DE</b>	<b>RU</b>
Suspension	Hängemontage	подвески
Pared	Wandbeleuchtungsgerät	Настенные
De techo	Deckenbeleuchtungsgerät	Потолочный подвес
Luminaria de suelo	Stehleuchte	Напольные светильники
Empotrables	Einbaubeleuchtungsgerät	Встраиваемые
Empotrables orientables	Verstellbar Einbaubeleuchtungsgerät	Встраиваемые регулируемые
De techo	Deckenbeleuchtungsgerät	Потолочный подвес
Luminaria de mesa	Tischlampe	Настольные светильники

22  
23

<b>ES</b>	<b>DE</b>	<b>RU</b>
LED es el acrónimo de LIGHT EMISSION DIODE	LED ist das Akronym für LIGHT EMISSION DIODE.	СИД – это акроним от СВЕТОИЗЛУЧАЮЩЕГО ДИОДА.
Certifica que el producto es realizado en el ambito de la Comunidad Europea y respeta las normas de seguridad vigentes.	Gibt an, dass das Produkt den Sicherheitsanforderungen der Richtlinien und Verordnungen der Europäischen Gemeinschaft entspricht.	Указывает на то, что продукт соответствует требованиям безопасности, разработанным применяемыми директивами законодательства в Европейском союзе.
Clase de aislamiento 1	Isolationsklasse 1	Класс изоляции 1
Clase de aislamiento 2	Isolationsklasse 2	Класс изоляции 2
CRI (Colour Rendering index) Indica el nivel de apariencia naturallos colores de los objetos iluminados.	CRI (Colour Rendering index) Gibt an, wie natürlich die Farben der von ihm beleuchteten Objekte erscheinen.	CRI (Показатель цветопередачи) Он указывает, насколько натурально выглядят цвета освещаемых предметов.
Indica el grado de proteccion de la luminaria al polvo y al agua	Sie gibt den Schutzgrad des Geräts vor Staub und Wasser an.	Он показывает степень защиты поверхностей.
Indica las tensiones operativas de la luminaria	Zeigt die Betriebsspannungen des Geräts an.	Это указывает рабочее электрическое напряжение светильника.
Indica las frecuencias operativas de la luminaria.	Zeigt die Betriebsfrequenzen des Geräts an.	Это указывает рабочую частоту светильника.

# LEGENDA

## SYMBOLS OF TECHNICAL DETAILS

SIMBOLI DEI DATI TECNICI | SYMBOLES DE DONNÉES TECHNIQUES | SÍMBOLOS DE DATOS TÉCNICOS | TECHNISCHE DATEN SYMBOLE  
 ТЕХНИЧЕСКИЕ ОБОЗНАЧЕНИЯ

	EN	IT	FR
	Degree of Protection against external mechanical impact	Indica il grado di resistenza all'urto dell'involucro esterno dell'apparecchio.	Indique le degré de protection de l'emballage du produit contre les impacts mécanique externes
	It indicates the flammability degree of plastic materials according to CEI 50-11 standards	Indica il grado di infiammabilità dei materiali plastici in accordo alle normative CEI 50-11.	Indique le degré d'auto-extinction des matières plastiques selon les standards CEI 50-11-
	Integrated power supply	Alimentatore integrato	Alimentation intégrée
	Separate power supply	Alimentatore separato	Alimentation séparée
	Energy consumption class	Classe energetica	Classe de consommation d'énergie
	Fitting with safety transformer. All parts under voltage, which may accidentally get in contact with the operator during the maintenance phases and installation, don't contain any dangerous voltage.	Apparecchio realizzato con trasformatore di sicurezza in cui tutte le parti in tensione che potrebbero entrare accidentalmente in contatto con l'operatore durante le fasi di manutenzione ed installazione, non contengono tensioni pericolose (<60V massimi a valle dell'alimentatore)	Appareil réalisé avec transformateur de sécurité où toutes les parties en tension, qui pourraient entrer accidentellement en contact avec l'opérateur pendant l'entretien et l'installation, ne contiennent pas de tensions dangereuses (<60V max en aval de l'alimentateur)
	Glare index	Indice di abbagliamento	Indice d'éblouissement
	Electrical wiring with data management DALI system	Schema di collegamento per sistemi DALI	Schéma de connexion pour appareil DALI
	Emergency Module in accordance with Norm EN 60598-2-22 available on request	Emergenza conforme alla norma EN 60598-2-22 disponibile su richiesta	Groupe d'urgence selon EN 60598-2-22 disponible sur demande
	Warranty More details on our website	Garanzia maggiori dettagli alla nostra pagina web	Garantie plus de détails sur notre page Web.
	Service Life LED	Aspettativa di vita del LED	Durée de vie LED

ES	DE	RU
Indica el grado de resistencia al impacto de la cubierta externa de la luminaria	Zeigt den Grad der Schlagfestigkeit des äußeren Gehäuses des Geräts an.	Степень защиты от воздействия внешних механических факторов
Indica el grado de auto extinción del material plástico según los estándares estadounidense CEI 50-11.	Gibt den Entzündbarkeitsgrad von Kunststoffen gemäß CEI 50-11 an.	Он указывает степень воспламеняемости пластиковых материалов в соответствии со стандартами CEI 50-11.
Fuente de alimentación integradal	Integrierte Stromversorgung	встроенный источник питания
Fuente de alimentación separada	Separate Stromversorgung	отдельный источник питания
Clase de consumo de energia	Energieverbrauchsklasse	Класс энергозатрат
Luminaria realizada contrasformador de seguridad cuyos componentes que accidentalmente pudieran entrar en contacto con el operador durante las etapas de mantenimiento o instalación, no contienen tensión peligrosa (<60 máxima después del balastro)	Gerät mit Sicherheitstransformator, bei dem alle spannungsführenden Teile, die während der Wartungs- und Installationsphasen versehentlich mit dem Bediener in Berührung kommen könnten, keine gefährlichen Spannungen enthalten (maximal <60 V nach der Spannungsversorgung)	Светильник с защитным трансформатором. Все элементы находящиеся под напряжением и которые могут контактировать с оператором во время эксплуатации либо установки, не находятся под опасным напряжением.
Indice de deslumbramiento	Blendungsindex	Индекс блёскости
Esquema de conexión luminaria DALI	Anschlussplan für DALI-Systeme	Электропроводка с системой управления DALI
Emergencia según EN 60598-2-22 disponible bajo pedido	Notfall gemäß EN 60598-2-22 auf Anfrage erhältlich	Аварийный модуль в соответствии с нормой EN 60598-2-22 предоставляется по запросу
Garantía más detalles en nuestra página web.	Garantie mehr Details auf unserer Webseite	Гарантия Дальнейшие детали на нашем сайте
Viad Util LED	Lebenswartung LED	Срок службы СИД



Lookup

# Suspension





# Aquadro

28  
29

# Aquadre i

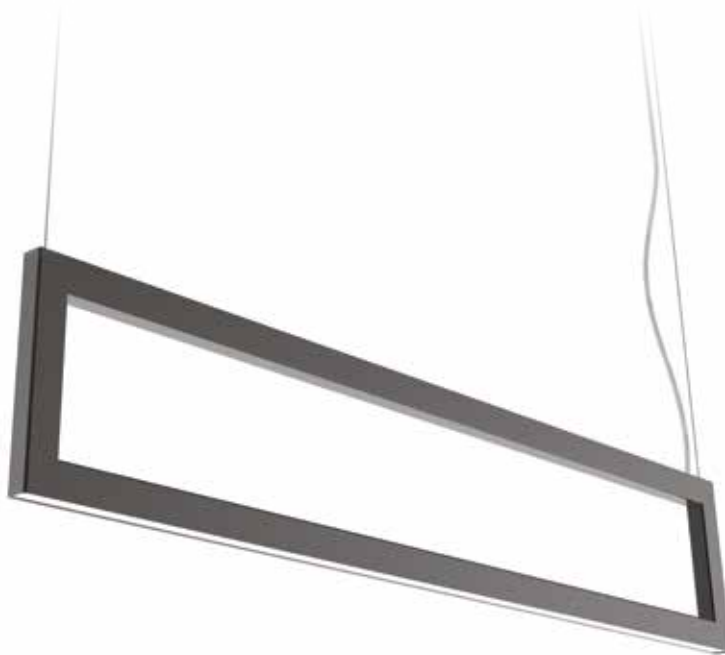

## Suspension



On request

### **IT**

Apparecchio decorativo per installazione a sospensione. Corpo in acciaio al carbonio pressopiegato. Sorgente luminosa LED multichip. Verniciatura con polveri epossidiche antigraffio. Schermo di chiusura in policarbonato microprismato. A richiesta schermo opale.

### **ES**

Luminaria decorativa de suspensión. Cuerpo de acero al carbono plegado. Fuente de iluminación LED multichip. Recubierta con polvo epoxi anti-rayado. Difusor de policarbonato microprismático. Bajo pedido: difusor opal.

### **EN**

Decorative suspension lighting fitting. Bent carbon steel body. Multichip LED lighting source. Anti-scratch epoxy powder paint finish. Microprismatic polycarbonate closing reflector. On request : opal reflector.

### **DE**

Dekoratives Hängebeleuchtungsgerät. Körper aus pressgeformtem Kohlenstoffstahl Multichip LED-Leuchtmittel. Lackierung mit kratzfesten Epoxypulvern. Abdeckschirm aus Mikroprismen-Polycarbonat. Auf Wunsch: Opalabdeckschirm

### **FR**

Appareil décoratifs en suspension. Corps en acier au carbone plies à la presse. Source de lumière en LED multichip. Finition de peinture en poudre époxy anti-rayures. Écran de fermeture en polycarbonate microprismatique. Sur demande écran opal.

### **RU**

Декоративный подвесной светильник. Корпус из прессованной углеродистой стали. Источник света мульткристалльный СИД. Покрытие устойчивым к царапинам эпоксидным порошком. Закрывающий экран выполнен из микропризматического поликарбоната. Матовый экран по запросу.



# AQUADRO i



## AQUADRO i VARIO *KELVIN*

Code	Size	Lumen	Watt	K	Beam angle	Driver Type	Driver no.	Colour
DIRECT + INDIRECT EMISSION (D+I)								
YAQI11VK	01	5280	58	Vario	D	ON/OFF	1	○
YAQI15VK	02	7200	80	Vario	D	ON/OFF	1	○

## AQUADRO i

Code	Size	Lumen	Watt	K	Beam angle	Driver Type	Driver no.	Colour
DIRECT + INDIRECT EMISSION (D+I)								
YAQI11W	01	5280	58	W	D	ON/OFF	1	○
YAQI15W	02	7200	80	W	D	ON/OFF	1	○

## ○ AQUADRO i COLOUR SELECTION

- **SB** | Silver Bombalai
- **BL** | Bronze Lario
- **RR** | Rust Rame
- **BF** | Beige Futuna
- **WI** | White Irazu
- **GK** | Gold Karkar
- **BT** | Blue Telica
- **BLL** | Black Lava

## AQUADRO i BEAM ANGLE | DIMENSIONS

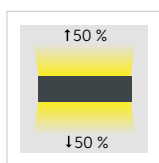

Size	X [mm]	Y [mm]	Z [mm]	Kg
<b>01</b>	1130	27	220	3,8
<b>02</b>	1530	27	220	5,0

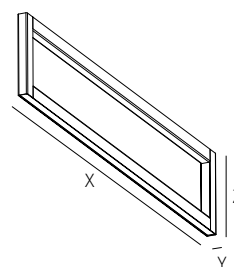

## AQUADRO i ACCESSORIES



### INCLUDED

- Rose ceiling for installation with built in driver for ceiling panel
- Ø Rose ceiling 70 mm | 60 mm
- 2 suspension cables, lenght: 2 mt

# Aquadre C



## Suspension



On request

### IT

Apparecchio decorativo per installazione a sospensione. Corpo in acciaio al carbonio pressopiegato. Sorgente luminosa LED multichip. Verniciatura con polveri epossidiche antigraffio. Schermo di chiusura in policarbonato microprismato. A richiesta schermo opale.

### ES

Luminaria decorativa de suspensión. Cuerpo de acero al carbono plegado. Fuente de iluminación LED multichip. Recubierta con polvo epoxi anti-rayado. Difusor de policarbonato microprismático. Bajo pedido: difusor opal.

### EN

Decorative suspension lighting fitting. Bent carbon steel body. Multichip LED lighting source. Anti-scratch epoxy powder paint finish. Microprismatic polycarbonate closing reflector. On request: opal reflector.

### DE

Dekoratives Hängebeleuchtungsgerät. Körper aus pressgeformtem Kohlenstoffstahl Multichip LED-Leuchtmittel. Lackierung mit kratzfesten Epoxypulvern. Abdeckschirm aus Mikroprismen-Polycarbonat. Auf Wunsch: Opalabdeckschirm

### FR

Appareil décoratifs en suspension. Corps en acier au carbone plies à la presse. Source de lumière en LED multichip. Finition de peinture en poudre époxy anti-rayures. Écran de fermeture en polycarbonate microprismatique. Sur demande écran opal.

### RU

Декоративный подвесной светильник. Корпус из прессованной углеродистой стали. Источник света мульткристальный СИД. Покрытие устойчивым к царапинам эпоксидным порошком. Закрывающий экран выполнен из микропризматического поликарбоната. Матовый экран по запросу.

# AQUADRO L



## AQUADRO L VARIO *KELVIN*

Code	Size	Lumen	Watt	K	Beam angle	Driver Type	Driver no.	Colour
DIRECT + INDIRECT EMISSION (D+I)								
YAQL11VK	01	5280	58	Vario	D	ON/OFF	1	○
YAQL15VK	02	7200	80	Vario	D	ON/OFF	1	○

## AQUADRO L

Code	Size	Lumen	Watt	K	Beam angle	Driver Type	Driver no.	Colour
DIRECT + INDIRECT EMISSION (D+I)								
YAQL11W	01	5280	58	W	D	ON/OFF	1	○
YAQL15W	02	7200	80	W	D	ON/OFF	1	○

## ○ AQUADRO L COLOUR SELECTION

- SB | Silver Bombalai
- BL | Bronze Lario
- RR | Rust Rame
- BF | Beige Futuna
- WI | White Irazu
- GK | Gold Karkar
- BT | Blue Telica
- BLL | Black Lava

## AQUADRO L BEAM ANGLE | DIMENSIONS

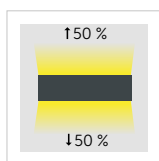

Size	X [mm]	Y [mm]	Z [mm]	Kg
01	1130	27	220	4,8
02	1530	27	220	6,2

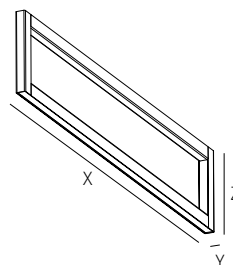

## AQUADRO L ACCESSORIES

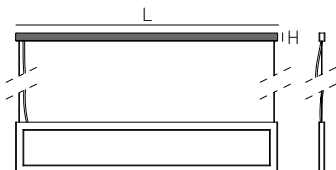

### INCLUDED

- Rose ceiling for brick installation
- Length (1130 mm - 1530 mm) | Height (45 mm)
- 2 suspension cables, length: 2 mt





Eliot

# Elia i



## Suspension



On request

### IT

Apparecchio decorativo per installazione a sospensione. Corpo in acciaio al carbonio pressopiegato. Sorgente luminosa LED multichip. Verniciatura con polveri epossidiche antigraffio. Schermo di chiusura in policarbonato microprismato. A richiesta schermo opale.

### ES

Luminaria decorativa de suspensión. Cuerpo de acero al carbono plegado. Fuente de iluminación LED multichip. Recubierta con polvo epoxi anti-rayado. Difusor de policarbonato microprismático. Bajo pedido: difusor opal.

### EN

Decorative suspension lighting fitting. Bent carbon steel body. Multichip LED lighting source. Anti-scratch epoxy powder paint finish. Microprismatic polycarbonate closing reflector. On request: opal reflector.

### DE

Dekoratives Hängebeleuchtungsgerät. Körper aus pressgeformtem Kohlenstoffstahl Multichip LED-Leuchtmittel. Lackierung mit kratzfesten Epoxypulvern. Abdeckschirm aus Mikroprismen-Polycarbonat. Auf Wunsch: Opalabdeckschirm

### FR

Appareil décoratif en suspension. Corps en acier au carbone plies à la presse. Source de lumière en LED multichip. Finition de peinture en poudre époxy anti-rayures. Écran de fermeture en polycarbonate microprismatique. Sur demande écran opal.

### RU

Декоративный подвесной светильник. Корпус из прессованной углеродистой стали. Источник света мульткристальный СИД. Покрытие устойчивым к царапинам эпоксидным порошком. Закрывающий экран выполнен из микропризматического поликарбоната. Матовый экран по запросу.



## ELIOT i VARIO *KELVIN*

Code	Size	Lumen	Watt	K	Beam angle	Driver Type	Driver no.	Colour
YELI11VK	01	5280	58	Vario	D	ON/OFF	1	○
YELI15VK	02	7200	79	Vario	D	ON/OFF	1	○

## ELIOT i

Code	Size	Lumen	Watt	K	Beam angle	Driver Type	Driver no.	Colour
YELI11W	01	5280	58	W	D	ON/OFF	1	○
YELI15W	02	7200	79	W	D	ON/OFF	1	○

## ○ ELIOT i COLOUR SELECTION

- **SB** | Silver Bombalai
- **BL** | Bronze Lario
- **RR** | Rust Rame
- **BF** | Beige Futuna
- **WI** | White Irazu
- **GK** | Gold Karkar
- **BT** | Blue Telica
- **BLL** | Black Lava

## ELIOT i BEAM ANGLE | DIMENSIONS



Size	X [mm]	Y [mm]	Z [mm]	Kg
<b>01</b>	1130	205	27	3,6
<b>02</b>	1530	205	27	4,8

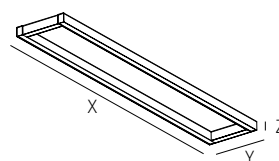

## ELIOT i ACCESSORIES



### INCLUDED

- Rose ceiling for installation with built in driver for ceiling panel
- Ø Rose ceiling 70 mm |  60 mm
- 2 suspension cables, lenght: 2 mt

# Elia C



2700K | 3350K | 4000K



## Suspension



On request

### IT

Apparecchio decorativo per installazione a sospensione. Corpo in acciaio al carbonio pressopiegato. Sorgente luminosa LED multichip. Verniciatura con polveri epossidiche antigraffio. Schermo di chiusura in policarbonato microprismato. A richiesta schermo opale.

### ES

Luminaria decorativa de suspensión. Cuerpo de acero al carbono plegado. Fuente de iluminación LED multichip. Recubierta con polvo epoxi anti-rayado. Difusor de policarbonato microprismático. Bajo pedido: difusor opal.

### EN

Decorative suspension lighting fitting. Bent carbon steel body. Multichip LED lighting source. Anti-scratch epoxy powder paint finish. Microprismatic polycarbonate closing reflector. On request: opal reflector.

### DE

Dekoratives Hängebeleuchtungsgerät. Körper aus pressgeformtem Kohlenstoffstahl Multichip LED-Leuchtmittel. Lackierung mit kratzfesten Epoxypulvern. Abdeckschirm aus Mikroprismen-Polycarbonat. Auf Wunsch: Opalabdeckschirm

### FR

Appareil décoratif en suspension. Corps en acier au carbone plies à la presse. Source de lumière en LED multichip. Finition de peinture en poudre époxy anti-rayures. Écran de fermeture en polycarbonate microprismatique. Sur demande écran opal

### RU

Декоративный подвесной светильник. Корпус из прессованной углеродистой стали. Источник света мульткристалльный СИД. Покрытие устойчивым к царапинам эпоксидным порошком. Закрывающий экран выполнен из микропризматического поликарбоната. Матовый экран по запросу.



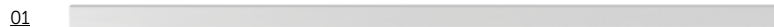

## ELIOT L VARIO *KELVIN*

Code	Size	Lumen	Watt	K	Beam angle	Driver Type	Driver no.	Colour
YELL11VK	01	5280	58	Vario	D	ON/OFF	1	○
YELL15VK	02	7200	79	Vario	D	ON/OFF	1	○

## ELIOT L

Code	Size	Lumen	Watt	K	Beam angle	Driver Type	Driver no.	Colour
YELL11W	01	5280	58	W	D	ON/OFF	1	○
YELL15W	02	7200	79	W	D	ON/OFF	1	○

## ○ ELIOT L COLOUR SELECTION

- SB | Silver Bombalai
- BL | Bronze Lario
- RR | Rust Rame
- BF | Beige Futuna
- WI | White Irazu
- GK | Gold Karkar
- BT | Blue Telica
- BLL | Black Lava

## ELIOT L BEAM ANGLE | DIMENSIONS



Size	X [mm]	Y [mm]	Z [mm]	Kg
01	1130	205	27	4,6
02	1530	205	27	6,0

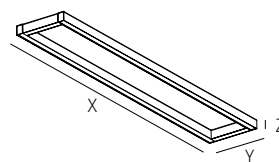

## ELIOT L ACCESSORIES

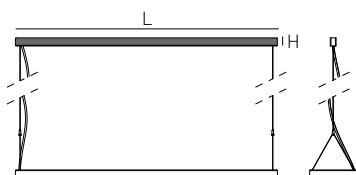

### INCLUDED

- Rose ceiling for brick installation
- Length (1130 mm - 1530 mm) | Height (45 mm)
- 2 suspension cables, length: 2 mt



*Lookup*



NORI

# Kerici



## Suspension



On request

### IT

Apparecchio decorativo per installazione a sospensione. Corpo in acciaio al carbonio pressopiegato. Sorgente luminosa LED multichip. Verniciatura con polveri epossidiche antigraffio. Schermo di chiusura in policarbonato microprismato. A richiesta schermo opale.

### ES

Luminaria decorativa de suspensión. Cuerpo de acero al carbono plegado. Fuente de iluminación LED multichip. Recubierta con polvo epoxi anti-rayado. Difusor de policarbonato microprismático. Bajo pedido: difusor opal.

### EN

Decorative suspension lighting fitting. Bent carbon steel body. Multichip LED lighting source. Anti-scratch epoxy powder paint finish. Microprismatic polycarbonate closing reflector. On request: opal reflector.

### DE

Dekoratives Hängebeleuchtungsgerät. Körper aus pressgeformtem Kohlenstoffstahl Multichip LED-Leuchtmittel. Lackierung mit kratzfesten Epoxypulvern. Abdeckschirm aus Mikroprismen-Polycarbonat. Auf Wunsch: Opalabdeckschirm

### FR

Appareil décoratif en suspension. Corps en acier au carbone plies à la presse. Source de lumière en LED multichip. Finition de peinture en poudre époxy anti-rayures. Écran de fermeture en polycarbonate microprismatique. Sur demande écran opal.

### RU

Декоративный подвесной светильник. Корпус из прессованной углеродистой стали. Источник света мульткристальный СИД. Покрытие устойчивым к царапинам эпоксидным порошком. Закрывающий экран выполнен из микропризматического поликарбоната. Матовый экран по запросу.

Lookup

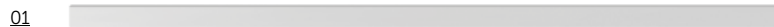

## NORI i VARIO *KELVIN*

Code	Size	Lumen	Watt	K	Beam angle	Driver Type	Driver no.	Colour
YNRI11VK	01	2640	29	Vario	D	ON/OFF	1	○
YNRI15VK	02	3600	40	Vario	D	ON/OFF	1	○

## NORI i

Code	Size	Lumen	Watt	K	Beam angle	Driver Type	Driver no.	Colour
YNRI11W	01	2640	29	W	D	ON/OFF	1	○
YNRI15W	02	3600	40	W	D	ON/OFF	1	○

## ○ NORI i COLOUR SELECTION

- **SB** | Silver Bombalai
- **BL** | Bronze Lario
- **RR** | Rust Rame
- **BF** | Beige Futuna
- **WI** | White Irazu
- **GK** | Gold Karkar
- **BT** | Blue Telica
- **BLL** | Black Lava

42  
43

## NORI i BEAM ANGLE | DIMENSIONS



Size	X [mm]	Y [mm]	Z [mm]	Kg
<b>01</b>	1205	27	35	1,2
<b>02</b>	1605	27	35	1,6

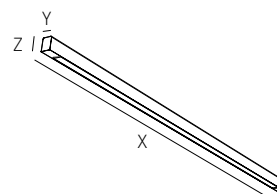

## NORI i ACCESSORIES



### INCLUDED

- Rose ceiling for installation with built in driver for ceiling panel
- Ø Rose ceiling 70 mm |  60 mm
- 2 suspension cables, lenght: 2 mt

# Meri C



## Suspension



On request

### IT

Apparecchio decorativo per installazione a sospensione. Corpo in acciaio al carbonio pressopiegato. Sorgente luminosa LED multichip. Verniciatura con polveri epossidiche antigraffio. Schermo di chiusura in policarbonato microprismato. A richiesta schermo opale.

### ES

Luminaria decorativa de suspensión. Cuerpo de acero al carbono plegado. Fuente de iluminación LED multichip. Recubierta con polvo epoxi anti-rayado. Difusor de policarbonato microprismático. Bajo pedido: difusor opal.

### EN

Decorative suspension lighting fitting. Bent carbon steel body. Multichip LED lighting source. Anti-scratch epoxy powder paint finish. Microprismatic polycarbonate closing reflector. On request: opal reflector.

### DE

Dekoratives Hängebeleuchtungsgerät. Körper aus pressgeformtem Kohlenstoffstahl Multichip LED-Leuchtmittel. Lackierung mit kratzfesten Epoxypulvern. Abdeckschirm aus Mikroprismen-Polycarbonat. Auf Wunsch: Opalabdeckschirm

### FR

Appareil décoratif en suspension. Corps en acier au carbone plies à la presse. Source de lumière en LED multichip. Finition de peinture en poudre époxy anti-rayures. Écran de fermeture en polycarbonate microprismatique. Sur demande écran opal.

### RU

Декоративный подвесной светильник. Корпус из прессованной углеродистой стали. Источник света мульткристальный СИД. Покрытие устойчивым к царапинам эпоксидным порошком. Закрывающий экран выполнен из микропризматического поликарбоната. Матовый экран по запросу.

Lookup

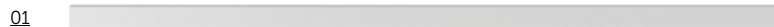

## NORI L VARIO *KELVIN*

Code	Size	Lumen	Watt	K	Beam angle	Driver Type	Driver no.	Colour
YNRL11VK	01	2640	29	Vario	D	ON/OFF	1	○
YNRL15VK	02	3600	40	Vario	D	ON/OFF	1	○

## NORI L

Code	Size	Lumen	Watt	K	Beam angle	Driver Type	Driver no.	Colour
YNRL11W	01	2640	29	W	D	ON/OFF	1	○
YNRL15W	02	3600	40	W	D	ON/OFF	1	○

## ○ NORI L COLOUR SELECTION

- SB | Silver Bombalai
- BL | Bronze Lario
- RR | Rust Rame
- BF | Beige Futuna
- WI | White Irazu
- GK | Gold Karkar
- BT | Blue Telica
- BLL | Black Lava

## NORI L BEAM ANGLE | DIMENSIONS



Size	X [mm]	Y [mm]	Z [mm]	Kg
01	1205	27	35	2,2
02	1605	27	35	3,1

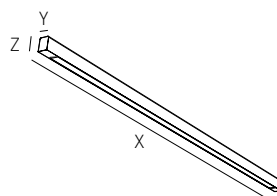

## NORI L ACCESSORIES

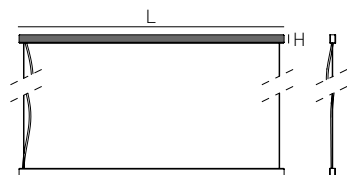

### INCLUDED

- Rose ceiling for brick installation
- Length (1205 mm - 1605 mm) | Height (45 mm)
- 2 suspension cables, length: 2 mt



*Lookup*





JEE

# Jeèi



Suspension



On request

## IT

Apparecchio decorativo per installazione a sospensione. Corpo in acciaio al carbonio pressopiegato. Sorgente luminosa LED multichip. Verniciatura con polveri epossidiche antigraffio. Micro ottiche in policarbonato alluminato

## EN

Decorative suspension lighting fitting. Bent carbon steel body. Multichip LED lighting source. Anti-scratch epoxy powder paint finish. Microholes shallow aluminum polycarbonate optics.

## FR

Appareil décoratif en suspension. Corps en acier au carbone plies à la presse. Source de lumière en LED multichip. Finition de peinture en poudre époxy anti-rayures. Microoptique dans le polycarbonate d'aluminium.

## ES

Luminaria decorativa de suspensión. Cuerpo de acero al carbono plegado. Fuente de iluminación LED multichip. Recubierta con polvo epoxi anti-rayado. Micro-ópticas de policarbonato aluminato.

## DE

Dekoratives Hängebeleuchtungsgerät. Körper aus pressgeformtem Kohlenstoffstahl. Multichip LED-Leuchtmittel. Lackierung mit kratzfesten Epoxypulvern. Mikrooptik aus aluminiertem Polycarbonat

## RU

Декоративный подвесной светильник. Корпус из прессованной углеродистой стали. Источник света мульткристалльный СИД. Покрытие устойчивым к царапинам эпоксидным порошком. Микро оптики выполнены из алюминатного поликарбоната.

01

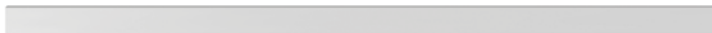

02



## JEÈ i

Code	Size	Lumen	Watt	K	Beam angle	Driver Type	Driver no.	Colour
YJEI11W	01	2680	25	W	D	ON/OFF	1	○
YJEI15W	02	3350	32	W	D	ON/OFF	1	○

## ○ JEÈ i | COLOUR SELECTION

- **SB** | Silver Bombalai
- **BL** | Bronze Lario
- **RR** | Rust Rame
- **BF** | Beige Futuna
- **WI** | White Irazu
- **GK** | Gold Karkar
- **BT** | Blue Telica
- **BLL** | Black Lava

## JEÈ i BEAM ANGLE | DIMENSIONS

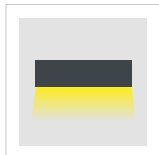

Size	X (mm)	Y (mm)	Z (mm)	Kg
<b>01</b>	1140	26	53	2,0
<b>02</b>	1425	26	53	2,8

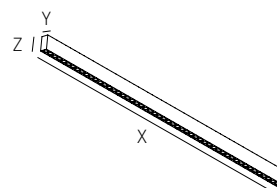

48  
49

## JEÈ i ACCESSOIRES



### INCLUDED

- Rose ceiling for installation with built in driver for ceiling panel
- Ø Rose ceiling 70 mm | 60 mm
- 2 suspension cables, lenght: 2 mt

jei C



Suspension



On request

**IT**

Apparecchio decorativo per installazione a sospensione. Corpo in acciaio al carbonio pressopiegato. Sorgente luminosa LED multichip. Verniciatura con polveri epossidiche antigraffio. Micro ottiche in policarbonato alluminato.

**EN**

Decorative suspension lighting fitting. Bent carbon steel body. Multichip LED lighting source. Anti-scratch epoxy powder paint finish. Microholes shallow aluminum polycarbonate optics.

**FR**

Appareil décoratif en suspension. Corps en acier au carbone plies à la presse. Source de lumière en LED multichip. Finition de peinture en poudre époxy anti-rayures. Microoptique dans le polycarbonate d'aluminium.

**ES**

Luminaria decorativa de suspensión. Cuerpo de acero al carbono plegado. Fuente de iluminación LED multichip. Recubierta con polvo epoxi anti-rayado. Micro-ópticas de policarbonato aluminato.

**DE**

Dekoratives Hängebeleuchtungsgerät. Körper aus pressgeformtem Kohlenstoffstahl Multichip LED-Leuchtmittel. Lackierung mit kratzfesten Epoxypulvern. Mikrooptik aus aluminiertem Polycarbonat

**RU**

Декоративный подвесной светильник. Корпус из прессованной углеродистой стали. Источник света мульткристальный СИД. Покрытие устойчивым к царапинам эпоксидным порошком. Микро оптики выполнены из алюминатного поликарбоната.

# JEÈ L

01



02



## JEÈ L

Code	Size	Lumen	Watt	K	Beam angle	Driver Type	Driver no.	Colour
YJEL11W	01	2680	25	W	D	ON/OFF	1	○
YJEL15W	02	3350	32	W	D	ON/OFF	1	○

## ○ JEÈ L | COLOUR SELECTION

- SB | Silver Bombalai
- BL | Bronze Lario
- RR | Rust Rame
- BF | Beige Futuna
- WI | White Irazu
- GK | Gold Karkar
- BT | Blue Telica
- BLL | Black Lava

## JEÈ L BEAM ANGLE | DIMENSIONS



Size	X (mm)	Y (mm)	Z (mm)	Kg
01	1140	26	53	3,0
02	1425	26	53	4,2

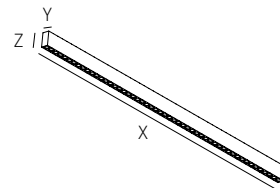

50  
51

## JEÈ L ACCESSORIES

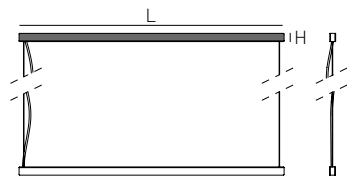

### INCLUDED

- Rose ceiling for brick installation
- Length (1140 mm - 1425 mm) | Height (45 mm)
- 2 suspension cables, length: 2 mt





Squak

# Squak



## Suspension



On request

### **IT**

Apparecchio decorativo per installazione a sospensione. Corpo in alluminio estruso. Sorgente luminosa LED multichip. Verniciatura con polveri epossidiche antigraffio. Schermo di chiusura in policarbonato opale.

### **EN**

Decorative suspension lighting fitting. Extruded aluminium body. Multichip LED lighting source. Anti-scratch epoxy powder paint finish. Opal polycarbonate closing reflector.

### **FR**

Appareil décoratif en suspension. Corps en aluminium extrudé. Source de lumière en LED multichip. Finition de peinture en poudre époxy anti-rayures. Écran de fermeture en polycarbonate opale.

### **ES**

Luminaria decorativa de suspensión. Cuerpo en aluminio extruido. Fuente de iluminación LED multichip. Recubierta con polvo epoxi anti-rayado. Difusor de policarbonato opal.

### **DE**

Dekoratives Hängebeleuchtungsgerät. Körper aus extrudiertem Aluminium. Multichip LED-Leuchtmittel. Lackierung mit kratzfesten Epoxypulvern. Abdeckschirm aus Opalpolycarbonat.

### **RU**

Декоративный подвесной светильник. Корпус из экструдированного алюминия. Источник света мульткристальный СИД. Покрытие устойчивым к царапинам эпоксидным порошком. Закрывающий экран выполнен из матового поликарбоната.



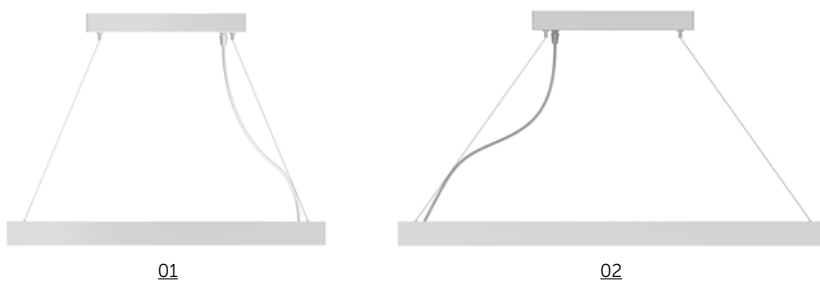

## SQUAK

Code	Size	Lumen	Watt	K	Beam angle	Driver Type	Driver no.	Colour
DIRECT EMISSION (D)								
YSQD60W	01	5270	57	W	D	ON/OFF	1	○
YSQD80W	02	7020	76	W	D	ON/OFF	1	○

Code	Size	Lumen	Watt	K	Beam angle	Driver Type	Driver no.	Colour
DIRECT + INDIRECT EMISSION (D+I)								
YSQDI60W	01	5270 + 2635	57 + 29	W	D	ON/OFF	1	○
YSQDI80W	02	7020 + 3510	76 + 38	W	D	ON/OFF	1	○

## ○ SQUAK COLOUR SELECTION

- SB | Silver Bombalai
- BL | Bronze Lario
- RR | Rust Rame
- BF | Beige Futuna
- WI | White Irazu
- GK | Gold Karkar
- BT | Blue Telica
- BLL | Black Lava

## SQUAK BEAM ANGLE | DIMENSIONS



D

D+I

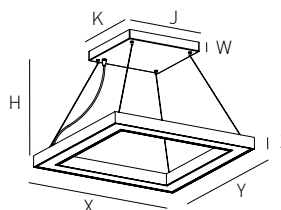

Size	X [mm]	Y [mm]	Z [mm]	K-J [mm]	W [mm]	H [mm]	Kg
01	600	600	45	300	40	500-2000	5,8
02	800	800	45	300	40	500-2000	7,8

## SQUAK ACCESSOIRES

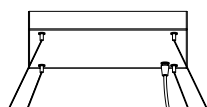

### INCLUDED

- Rose ceiling for brick installation
- For dimensions see above table
- 4 suspension cables, lenght: 2 mt





Loft

# Ceft



Suspension

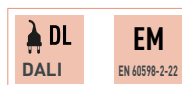

On request

## IT

Apparecchio decorativo per installazione a sospensione. Corpo in alluminio tornito. Sorgente luminosa LED multichip. Verniciatura con polveri epossidiche antigraffio. Schermo di chiusura in policarbonato opale.

## EN

Decorative suspension lighting fitting. Turned aluminium body. Multichip LED lighting source. Anti-scratch epoxy powder paint finish. Opal polycarbonate closing reflector.

## FR

Appareil décoratif en suspension. Corps en aluminium tourné. Source de lumière en LED multichip. Finition de peinture en poudre époxy anti-rayures. Écran de fermeture en polycarbonate opale.

## ES

Luminaria decorativa de suspensión. Cuerpo en aluminio torneado. Fuente de iluminación LED multichip. Recubierta con polvo epoxi anti-rayado. Difusor de policarbonato opal.

## DE

Dekoratives Hängebeleuchtungsgerät. Körper aus gedrehtem Aluminium. Multichip LED-Leuchtmittel. Lackierung mit kratzfesten Epoxypulvern. Abdeckschirm aus Opalpolycarbonat.

## RU

Декоративный подвесной светильник. Корпус из формованного алюминия. Источник света мульткристальный СИД. Покрытие устойчивым к царапинам эпоксидным порошком. Закрывающий экран выполнен из матового поликарбоната.

Lookup



## LOFT VARIO **LUMEN** | VARIO **KELVIN**

Code	Size	Vario Lumen	Watt	K	Beam angle	Driver Type	Driver no.	Colour
YLO20VKL	01	1050   1570   2090	10   15   20	Vario	D	ON/OFF	1	○

## LOFT

Code	Size	Lumen	Watt	K	Beam angle	Driver Type	Driver no.	Colour
YLO16W	01	1710	16	W	D	ON/OFF	1	○
YLO23W	01	2440	23	W	D	ON/OFF	1	○
YLO30W	01	3170	30	W	D	ON/OFF	1	○
YLO39W	01	4150	39	W	D	ON/OFF	1	○

## ○ LOFT COLOUR SELECTION

- **SB** | Silver Bombalai
- **BL** | Bronze Lario
- **RR** | Rust Rame
- **BF** | Beige Futuna
- **WI** | White Irazu
- **GK** | Gold Karkar
- **BT** | Blue Telica
- **BLL** | Black Lava

## LOFT BEAM ANGLE | DIMENSIONS

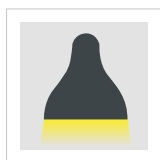

Size	X [mm]	Z [mm]	Kg
01	ø 440	470	3,8

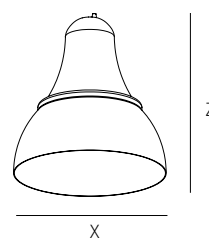

## LOFT ACCESSORIES

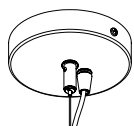

### INCLUDED

- Rose ceiling for brick installation
- Ø Rose ceiling 120 mm | Height (25 mm)
- Suspension cable lenght: 2 mt





# Maciste

60  
61

# Maciste



## Suspension



On request

### IT

Apparecchio decorativo per installazione a sospensione. Corpo in alluminio tornito. Sorgente luminosa LED multichip. Verniciatura con polveri epossidiche antigraffio. Schermo di chiusura in policarbonato opale.

### EN

Decorative suspension lighting fitting. Turned aluminium body. Multichip LED lighting source. Anti-scratch epoxy powder paint finish. Opal polycarbonate closing reflector.

### FR

Appareil décoratif en suspension. Corps en aluminium tourné. Source de lumière en LED multichip. Finition de peinture en poudre époxy anti-rayures. Écran de fermeture en polycarbonate opale.

### ES

Luminaria decorativa de suspensión. Cuerpo en aluminio torneado. Fuente de iluminación LED multichip. Recubierta con polvo epoxi anti-rayado. Difusor de policarbonato opal.

### DE

Dekoratives Hängebeleuchtungsgerät. Körper aus gedrehtem Aluminium Multichip LED-Leuchtmittel. Lackierung mit kratzfesten Epoxypulvern. Abdeckschirm aus Opalpolycarbonat.

### RU

Декоративный подвесной светильник. Корпус из формованного алюминия. Источник света мульткристальный СИД. Покрытие устойчивым к царапинам эпоксидным порошком. Закрывающий экран выполнен из матового поликарбоната.



# MACISTE



## MACISTE VARIO **LUMEN** | VARIO **KELVIN**

Code	Size	Vario Lumen	Watt	K	Beam angle	Driver Type	Driver no.	Colour
YMA20VKL	01	1050   1570   2090	10   15   20	Vario	D	ON/OFF	1	○

## MACISTE

Code	Size	Lumen	Watt	K	Beam angle	Driver Type	Driver no.	Colour
YMA16W	01	1710	16	W	D	ON/OFF	1	○
YMA23W	01	2440	23	W	D	ON/OFF	1	○
YMA30W	01	3170	30	W	D	ON/OFF	1	○
YMA39W	01	4150	39	W	D	ON/OFF	1	○

## ○ MACISTE COLOUR SELECTION

- **SB** | Silver Bombalai
- **BL** | Bronze Lario
- **RR** | Rust Rame
- **BF** | Beige Futuna
- **WI** | White Irazu
- **GK** | Gold Karkar
- **BT** | Blue Telica
- **BLL** | Black Lava

62  
63

## MACISTE BEAM ANGLE | DIMENSIONS

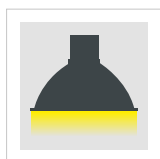

Size	X (mm)	Z (mm)	Kg
01	ø 690	490	13,0

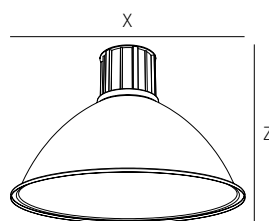

## MACISTE ACCESSORIES

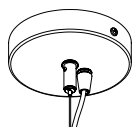

### INCLUDED

- Rose ceiling for brick installation
- Ø Rose ceiling 120 mm | Height (25 mm)
- Suspension cable lenght: 2 mt



*Lookup*



# Round

# Round



2700K | 3350K | 4000K



Suspension

Ceiling mounted



**5Y WARRANTY**  
5% FAILURE RATE

**60.000 h**  
LED LIFETIME L90B10



On request

## IT

Apparecchio decorativo per installazione a sospensione o plafone. Corpo in alluminio tornito. Sorgente luminosa LED multichip. Verniciatura con polveri epossidiche antigraffio. Schermo di chiusura in policarbonato opale.

## EN

Decorative suspension or ceiling mounted lighting fitting. Turned aluminum body. Multichip LED lighting source. Anti-scratch epoxy powder paint finish. Opal polycarbonate closing reflector.

## FR

Appareil décoratif en suspension ou plafond. Corps en aluminium tourné. Source de lumière en LED multichip. Finition de peinture en poudre époxy anti-rayures. Écran de fermeture en polycarbonate opale.

## ES

Luminaria decorativa de suspensión o techo. Cuerpo en aluminio torneado. Fuente de iluminación LED multichip. Recubierta con polvo epoxi anti-rayado. Difusor de policarbonato opal.

## DE

Dekoratives Hänge- und Deckenbeleuchtungsgerät. Körper aus gedrehtem Aluminium Multichip LED-Leuchtmittel. Lackierung mit kratzfesten Epoxypulvern. Abdeckschirm aus Opalpolycarbonat.

## RU

Декоративный подвесной и потолочный светильник. Корпус из формованного алюминия. Источник света мульткристальный СИД. Покрытие устойчивым к царапинам эпоксидным порошком. Закрывающий экран выполнен из матового поликарбоната.

Lookup

# ROUND



01



02



03



04

## ROUND ONLY FOR SUSPENSION VERSION VARIO LUMEN | VARIO KELVIN

Code	Size	Vario Lumen	Watt	K	Beam angle	Driver Type	Driver no.	Colour
YRO55VKL	03	3350   5030   6700	36   54   73	Vario	D	ON/OFF	1	○
YRO75VKL	04	6030   9050   12060	65   98   131	Vario	D	ON/OFF	1	○

## ROUND

Code	Size	Lumen	Watt	K	Beam angle	Driver Type	Driver no.	Colour
YRO27W	01	1050	13	W	D	ON/OFF	1	○
YRO36W	02	1750	21	W	D	ON/OFF	1	○
YRO55W	03	6700	73	W	D	ON/OFF	1	○
YRO75W	04	12060	131	W	D	ON/OFF	1	○

## ○ ROUND COLOUR SELECTION

● SB | Silver Bombalai

● BL | Bronze Lario

● RR | Rust Rame

● BF | Beige Futuna

● WI | White Irazu

● GK | Gold Karkar

● BT | Blue Telica

● BLL | Black Lava

66  
67

## ROUND BEAM ANGLE | DIMENSIONS



Size	X (mm)	Z (mm)	Kg
01	ø 270	90	2,7
02	ø 360	90	3,7
03	ø 550	110	5,8
04	ø 750	110	8,0

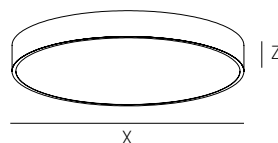

## ROUND SPECIAL FEATURES

- On request: direct + indirect emission (D+I)

## ROUND ACCESSORIES

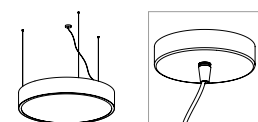

KIT YKT35

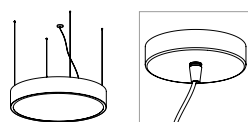

KIT YKT45

### NOT INCLUDED

- Order code (size 01-02): **YKT35** | Rose ceiling for brick installation Ø 120 mm - H 25 mm | 3 suspension cables, lenght: 2 mt
- Order code (size 03-04): **YKT45** | Rose ceiling for brick installation Ø 120 mm - H 25 mm | 4 suspension cables, lenght: 2 mt





# Round IP55

68  
69

# Round 1755



2700K | 3350K | 4000K



Suspension

Ceiling mounted



**5Y WARRANTY**  
5% FAILURE RATE

**60.000 h**  
LED LIFETIME L90B10

**DL**  
DALI

**EM**  
EN 60598-2-22

On request

## IT

Apparecchio decorativo per installazione a sospensione e plafone. Corpo in acciaio al carbonio calandrato e pressopiegato. Sorgente luminosa LED multichip. Verniciatura con polveri epossidiche antigraffio. Schermo di chiusura in policarbonato opale.

## ES

Luminaria decorativa de suspensión o techo. Cuerpo de acero al carbono plegado y calandrado. Fuente de iluminación LED multichip. Recubierta con polvo epoxi anti-rayado. Difusor de policarbonato opal.

## EN

Decorative suspension or ceiling mounted lighting fitting. Bent and calendered carbon steel body. Multichip LED lighting source. Anti-scratch epoxy powder paint finish. Opal polycarbonate closing reflector.

## DE

Dekoratives Hänge- und Deckenbeleuchtungsgerät. Körper aus kalandriertem und pressgeformtem Kohlenstoffstahl. Multichip LED-Leuchtmittel. Lackierung mit kratzfesten Epoxypulvern. Abdeckschirm aus Opalepolycarbonat.

## FR

Appareil décoratif en suspension ou plafond. Corps en acier au carbone pliés à la presse et calandré. Source de lumière en LED multichip. Finition de peinture en poudre époxy anti-rayures. Écran de fermeture en polycarbonate opale.

## RU

Декоративный подвесной и потолочный светильник. Корпус из прессованной и каландрированной углеродистой стали. Источник света мультикристалльный СИД. Покрытие устойчивым к царапинам эпоксидным порошком. Закрывающий экран выполнен из матового поликарбоната



# ROUND IP55



01



02



03

## ROUND IP55 ONLY FOR SUSPENSION VERSION VARIO LUMEN | VARIO KELVIN

Code	Size	Vario Lumen	Watt	K	Beam angle	Driver Type	Driver no.	Colour
YRO60VKL	01	3350   5030   6700	36   54   73	Vario	D	ON/OFF	1	○
YRO90VKL	02	6700   10050   13400	73   109   145	Vario	D	ON/OFF	1	○
YRO120VKL	03	12060   18090   24120	131   196   261	Vario	D	ON/OFF	1	○

## ROUND IP55

Code	Size	Lumen	Watt	K	Beam angle	Driver Type	Driver no.	Colour
YRO60W	01	6700	73	W	D	ON/OFF	1	○
YRO90W	02	13400	145	W	D	ON/OFF	1	○
YRO120W	03	24120	261	W	D	ON/OFF	1	○

## ○ ROUND IP55 COLOUR SELECTION

- SB | Silver Bombalai
- BL | Bronze Lario
- RR | Rust Rame
- BF | Beige Futuna
- WI | White Irazu
- GK | Gold Karkar
- BT | Blue Telica
- BLL | Black Lava

## ROUND IP55 BEAM ANGLE | DIMENSIONS



Size	X (mm)	Z (mm)	Kg
01	∅ 600	150	10,0
02	∅ 900	150	20,5
03	∅ 1200	150	38,0

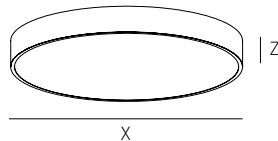

## ROUND IP55 ACCESSORIES

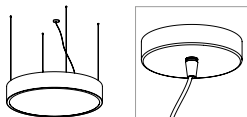

KIT YKT45

**NOT INCLUDED**

- Order code: **YKT45** | Rose ceiling for brick installation ∅ 120 mm - Height (25 mm) | 4 suspension cables, lenght: 2 mt





# Arroondo

$\frac{72}{73}$

# Arrende



Suspension



**19**  
UGR

**5Y WARRANTY**  
5% FAILURE RATE

**60.000 h**  
LED LIFETIME **L90B10**

**DL**  
DALI

**EM**  
EN 60598-2-22

On request

## IT

Apparecchio decorativo per installazione a sospensione. Corpo in acciaio al carbonio calandrato e pressopiegato. Sorgente luminosa LED multichip. Verniciatura con polveri epossidiche antigraffio. Schermo di chiusura in policarbonato microprismato. A richiesta schermo opale.

## ES

Luminaria decorativa de suspensión. Cuerpo de acero al carbono plegado y calandrado. Fuente de iluminación LED multichip. Recubierta con polvo epoxi anti-rayado. Difusor de policarbonato microprismático. Bajo pedido: difusor opal.

## EN

Decorative suspension lighting fitting. Bent and calendered carbon steel body. Multichip LED lighting source. Anti-scratch epoxy powder paint finish. Microprismatic polycarbonate closing reflector. On request : opal reflector.

## DE

Dekoratives Hängebeleuchtungsgerät. Körper aus kalandriertem und pressgeformtem Kohlenstoffstahl Multichip LED-Leuchtmittel. Lackierung mit kratzfesten Epoxypulvern. Abdeckschirm aus Mikroprismen-Polycarbonat. Auf Wunsch: Opalabdeckschirm.

## FR

Appareil décoratif en suspension. Corps en acier au carbone plies à la presse et calandré. Source de lumière en LED multichip. Finition de peinture en poudre époxy anti-rayures. Écran de fermeture en polycarbonate microprismatique. Sur demande écran opal.

## RU

Декоративный подвесной светильник. Корпус из прессованной и каландрированной углеродистой стали. Источник света мульткристальный СИД. Покрытие устойчивым к царапинам эпоксидным порошком. Закрывающий экран выполнен из микропризматического поликарбоната. Матовый экран по запросу

Lookup

# ARRONDO



01



02



03



04



05

## ARRONDO VARIO *KELVIN*

Code	Size	Lumen	Watt	K	Beam angle	Driver Type	Driver no.	Colour
YAR10VK	01	9190	87	Vario	D	ON/OFF	1	○
YAR12VK	02	11280	107	Vario	D	ON/OFF	1	○
YAR15VK	03	13790	131	Vario	D	ON/OFF	1	○
YAR20VK	04	18800	178	Vario	D	ON/OFF	1	○
YAR30VK	05	30070	285	Vario	D	ON/OFF	1	○

## ARRONDO

Code	Size	Lumen	Watt	K	Beam angle	Driver Type	Driver no.	Colour
YAR10W	01	9190	87	W	D	ON/OFF	1	○
YAR12W	02	11280	107	W	D	ON/OFF	1	○
YAR15W	03	13790	131	W	D	ON/OFF	1	○
YAR20W	04	18800	178	W	D	ON/OFF	1	○
YAR30W	05	30070	285	W	D	ON/OFF	1	○

## ○ ARRONDO COLOUR SELECTION

- **SB** | Silver Bombalai
- **BL** | Bronze Lario
- **RR** | Rust Rame
- **BF** | Beige Futuna
- **WI** | White Irazu
- **GK** | Gold Karkar
- **BT** | Blue Telica
- **BLL** | Black Lava

## ARRONDO BEAM ANGLE | DIMENSIONS



Size	X (mm)	Y (mm)	Z (mm)	Kg
<b>01</b>	∅ 1000	100	80	18,0
<b>02</b>	∅ 1200	100	80	21,5
<b>03</b>	∅ 1500	100	80	27,0
<b>04</b>	∅ 2000	100	80	36,0
<b>05</b>	∅ 3000	100	100	54,0

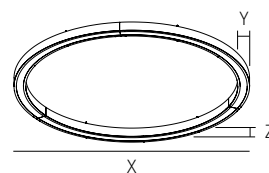

## ARRONDO ACCESSORIES

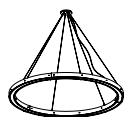

KIT YKTC65

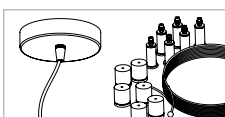
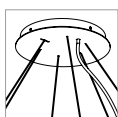

KIT YKT65

### NOT INCLUDED

- Order code: **YKTC65** | Central fixing rose, cables lenght to be agreed with the technical office
- Order code: **YKT65** | Rose ceiling for brick installation ∅ 120 mm - Height (25 mm) | 6 suspension cables, lenght: 2 mt





Ufo

Ultra



## Suspension



On request

### IT

Apparecchio decorativo per installazione a sospensione. Corpo in alluminio tornito. Sorgente luminosa con LED COB. Verniciatura con polveri epossidiche antigraffio. Schermo di chiusura in policarbonato opale.

### EN

Decorative suspension lighting fitting. Turned aluminum body. Light source with LED COB. Anti-scratch epoxy powder paint finish. Opal polycarbonate closing reflector.

### FR

Appareil décoratif en suspension. Corps en aluminium tourné. Source lumineuse avec LED COB. Finition de peinture en poudre époxy anti-rayures. Écran de fermeture en polycarbonate opale.

### ES

Luminaria decorativa de suspensión. Cuerpo en aluminio torneado. Fuente de iluminación con LED COB. Recubierta con polvo epoxi anti-rayado. Difusor de policarbonato opal.

### DE

Dekoratives Hängebeleuchtungsgerät. Körper aus gedrehtem Aluminium. Leuchtmittel mit LED COB. Lackierung mit kratzfesten Epoxypulvern. Abdeckschirm aus Opalepolycarbonat.

### RU

Декоративный подвесной светильник. Корпус из формованного алюминия. Источник света COB СИД. Покрытие устойчивым к царапинам эпоксидным порошком.

Lookup



# UFO



## UFO

Code	Size	Lumen	Watt	K	Beam angle	Driver Type	Driver no.	Colour
YUF01W	01	2100	23	W	D	ON/OFF	1	○

## ○ UFO COLOUR SELECTION

- **SB** | Silver Bombalai
- **BL** | Bronze Lario
- **RR** | Rust Rame
- **BF** | Beige Futuna
- **WI** | White Irazu
- **GK** | Gold Karkar
- **BT** | Blue Telica
- **BLL** | Black Lava

## UFO BEAM ANGLE | DIMENSIONS

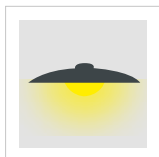

Size	X (mm)	Z (mm)	Kg
<b>01</b>	Ø 500	95	1,2

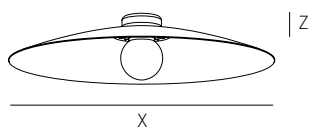

78  
79

## UFO ACCESSORIES

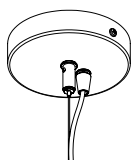

### INCLUDED

- Rose ceiling for brick installation
- Ø Rose ceiling 120 mm | Height (25 mm)
- Suspension cable lenght: 2 mt





Tubi

# Tubi cm



Ceiling mounted



## **IT**

Apparecchio decorativo per installazione a plafone. Corpo in alluminio estruso. Sorgente luminosa LED COB. Verniciatura con polveri epossidiche antigraffio. Schermo di chiusura in metacrilato trasparente

## **ES**

Luminaria decorativa para instalación en techo. Cuerpo en aluminio extruido. Fuente de iluminación LED COB. Recubierta con polvo epoxi anti-rayado. Difusor de metacrilato transparente.

## **EN**

Decorative ceiling mounted lighting fitting. Extruded aluminium body. LED COB light source. Anti-scratch epoxy powder paint finish. Transparent methacrylate closing reflector.

## **DE**

Dekoratives Deckenbeleuchtungsgerät. Körper aus extrudiertem Aluminium. COB LED Leuchtmittel. Lackierung mit kratzfesten Epoxypulvern. Abdeckschirm aus transparentem Methacrylat.

## **FR**

Appareil décoratif ou plafond. Corps en aluminium extrudé. Source lumineuse LED COB. Finition de peinture en poudre époxy anti-rayures. Écran de fermeture en méthacrylate transparent.

## **RU**

Декоративный потолочный светильник. Корпус из экструдированного алюминия. Источник света СИД COB. Покрытие устойчивым к царапинам эпоксидным порошком. Закрывающий экран выполнен из прозрачного метакрилата.

# TUBÌ CM

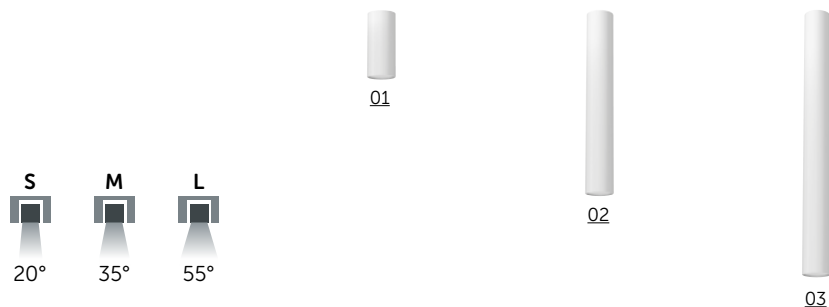

## TUBÌ CM

Code	Size	Lumen	Watt	K	Beam angle	Driver Type	Driver no.	Colour
YTUCM14SW	01	1350	11	W	S	ON/OFF	1	○
YTUCM14MW	01	1350	11	W	M	ON/OFF	1	○
YTUCM14LW	01	1350	11	W	L	ON/OFF	1	○
YTUCM40SW	02	1350	11	W	S	ON/OFF	1	○
YTUCM40MW	02	1350	11	W	M	ON/OFF	1	○
YTUCM40LW	02	1350	11	W	L	ON/OFF	1	○
YTUCM60SW	03	1350	11	W	S	ON/OFF	1	○
YTUCM60MW	03	1350	11	W	M	ON/OFF	1	○
YTUCM60LW	03	1350	11	W	L	ON/OFF	1	○

## ○ TUBÌ CM COLOUR SELECTION

- SB | Silver Bombalai
- BL | Bronze Lario
- RR | Rust Rame
- BF | Beige Futuna
- WI | White Irazu
- GK | Gold Karkar
- BT | Blue Telica
- BLL | Black Lava

82  
83

## TUBÌ CM BEAM ANGLE | DIMENSIONS

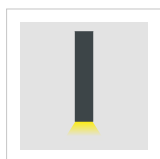

Size	X (mm)	Y (mm)	Kg
01	∅ 60	135	0,25
02	∅ 60	400	0,75
03	∅ 60	600	1,00

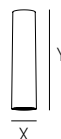

# Tubi r



Suspension



## IT

Apparecchio decorativo per installazione a sospensione. Corpo in alluminio estruso. Sorgente luminosa LED COB. Verniciatura con polveri epossidiche antigraffio. Schermo di chiusura in metacrilato trasparente

## ES

Luminaria decorativa de suspensión. Cuerpo en aluminium extruido. Fuente de iluminación LED COB. Recubierta con polvo epoxi anti-rayado. Difusor de metacrilato transparente.

## EN

Decorative suspension lighting fitting. Extruded aluminium body. LED COB light source. Anti-scratch epoxy powder paint finish. Transparent methacrylate closing reflector.

## DE

Dekoratives Hängebeleuchtungsgerät. Körper aus extrudiertem Aluminium COB LED Leuchtmittel. Lackierung mit kratzfesten Epoxypulvern. Abdeckschirm aus transparentem Methacrylat.

## FR

Appareil décoratif en suspension. Corps en aluminium extrudé. Source lumineuse avec LED COB. Finition de peinture en poudre époxy anti-rayures. Écran de fermeture en méthacrylate transparent.

## RU

Декоративный подвесной светильник. Корпус из экструдированного алюминия. Источник света СИД COB. Покрытие устойчивым к царапинам эпоксидным порошком. Закрывающий экран выполнен из прозрачного метакрилата.

# TUBÌ S

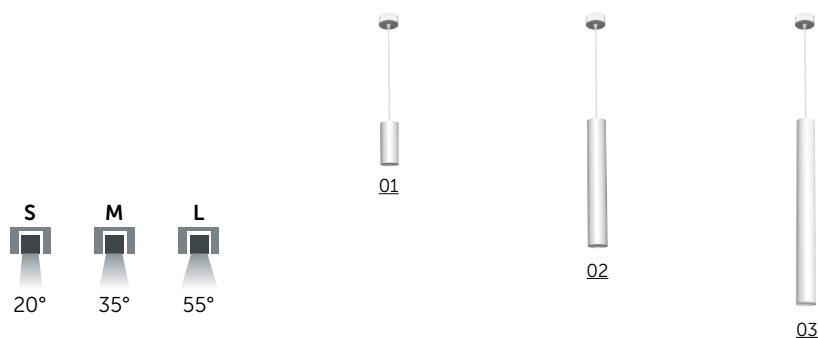

## TUBÌ S

Code	Size	Lumen	Watt	K	Beam angle	Driver Type	Driver no.	Colour
YTUS14SW	01	1350	11	W	S	ON/OFF	1	○
YTUS14MW	01	1350	11	W	M	ON/OFF	1	○
YTUS14LW	01	1350	11	W	L	ON/OFF	1	○
YTUS40SW	02	1350	11	W	S	ON/OFF	1	○
YTUS40MW	02	1350	11	W	M	ON/OFF	1	○
YTUS40LW	02	1350	11	W	L	ON/OFF	1	○
YTUS60SW	03	1350	11	W	S	ON/OFF	1	○
YTUS60MW	03	1350	11	W	M	ON/OFF	1	○
YTUS60LW	03	1350	11	W	L	ON/OFF	1	○

## ○ TUBÌ S COLOUR SELECTION

- **SB** | Silver Bombalai
- **BL** | Bronze Lario
- **RR** | Rust Rame
- **BF** | Beige Futuna
- **WI** | White Irazu
- **GK** | Gold Karkar
- **BT** | Blue Telica
- **BLL** | Black Lava

84  
85

## TUBÌ S BEAM ANGLE | DIMENSIONS

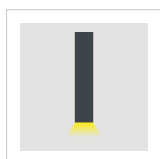

Size	X (mm)	Y (mm)	Z (mm)	Kg
<b>01</b>	∅ 60	135	1500	0,3
<b>02</b>	∅ 60	400	1500	0,8
<b>03</b>	∅ 60	600	1500	1,1

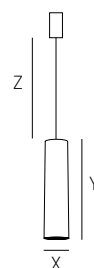

## TUBÌ S ACCESSORIES



### INCLUDED

- Rose ceiling for brick installation
- ∅ Rose ceiling 60 mm | Height (30 mm)
- Suspension cable, lenght: 1.5 mt





# TUBÌ - CONFIGURATION

## SPECIAL ROSE

On request: special roses with customizable dimensions.



ARCO



SOLE

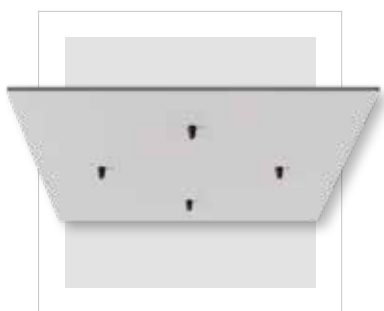

APPOGGIO 595x595 mm



ONDA



ANELLO





# Addalpoina

88  
89

# Alpina



Suspension



On request

## IT

Apparecchio decorativo per installazione a sospensione. Vano alimentatore in alluminio estruso verniciato con polveri epossidiche antigraffio. Sorgente luminosa LED multichip. Corpo diffusore in policarbonato opale.

## ES

Luminaria decorativa de suspensión. Unidad de alimentación en aluminio extruido recubierta con polvo epoxi anti-rayado. Fuente de iluminación LED multichip. Cuerpo difusor de policarbonato opal.

## EN

Decorative suspension lighting fitting. Extruded aluminium power supply compartment painted with anti-scratch epoxy powder paint. Multichip LED lighting source. Opal polycarbonate diffuser.

## DE

Dekoratives Hängebeleuchtungsgerät. Feeder-Einheit aus extrudiertem Aluminium, lackiert mit kratzfestem Epoxidpulver. Multichip LED-Leuchtmittel. Diffusor Koerper aus opalem Polycarbonat.

## FR

Appareil décoratif en suspension. Unité d'alimentation en aluminium extrudé finition de peinture en poudre époxy anti-rayures. Source de lumière en LED multichip. Corps diffuseur en polycarbonato opale.

## RU

Декоративный подвесной светильник. Отсек для блока питания из экструдированного алюминия, покрытого устойчивым к царапинам эпоксидным порошком. Источник света мультикристальный СИД. Корпус-диффузор из матового поликарбоната.

# ADALPINA



## ADALPINA VARIO *KELVIN*

Code	Size	Lumen	Watt	K	Beam angle	Driver Type	Driver no.	Colour
YAD13VK	01	4200	53	Vario	D	ON/OFF	1	○
YAD18VK	02	6300	79	Vario	D	ON/OFF	1	○
YAD23VK	03	8400	106	Vario	D	ON/OFF	1	○

## ADALPINA

Code	Size	Lumen	Watt	K	Beam angle	Driver Type	Driver no.	Colour
YAD13W	01	4200	53	W	D	ON/OFF	1	○
YAD18W	02	6300	79	W	D	ON/OFF	1	○
YAD23W	03	8400	106	W	D	ON/OFF	1	○

## ○ ADALPINA COLOUR SELECTION

- **SB** | Silver Bombalai
- **BL** | Bronze Lario
- **RR** | Rust Rame
- **BF** | Beige Futuna
- **WI** | White Irazu
- **GK** | Gold Karkar
- **BT** | Blue Telica
- **BLL** | Black Lava

## ADALPINA BEAM ANGLE | DIMENSIONS

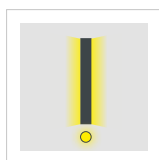

Size	X (mm)	Y (mm)	Z (mm)	K (mm)	J (mm)	Kg
<b>01</b>	ø 83	ø 90	1350	1000	350	3,2
<b>02</b>	ø 83	ø 90	1850	1500	350	4,5
<b>03</b>	ø 83	ø 90	2350	2000	350	5,8

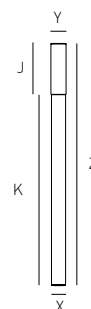

## ADALPINA ACCESSORIES

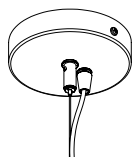

### INCLUDED

- Rose ceiling for brick installation
- Ø Rose ceiling 120 mm | Height (25 mm)
- Suspension cable, lenght: 2 mt



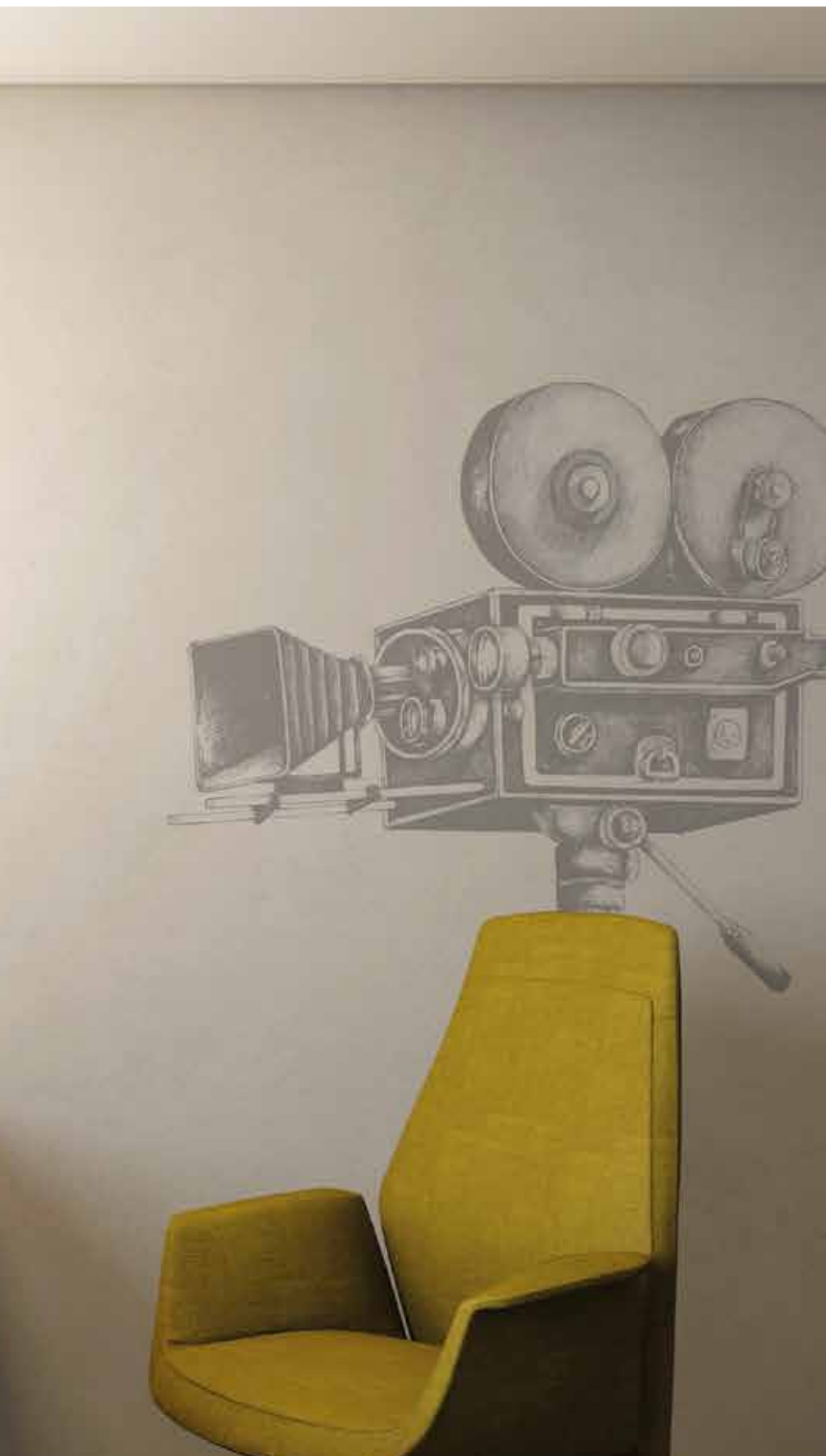

Circo

# Cinca



Suspension



## **IT**

Apparecchio decorativo per installazione a sospensione. Corpo in alluminio estruso calandrato. Sorgente luminosa LED multichip. Verniciatura con polveri epossidiche antigraffio. Schermo di chiusura in silicone opale.

## **ES**

Luminaria decorativa de suspensión. Cuerpo en aluminio extruido calandrado. Fuente de iluminación LED multichip. Recubierta con polvo epoxi anti-rayado. Difusor de silicona opale.

## **EN**

Decorative suspension lighting fitting. Calendered extruded aluminum body. Multichip LED lighting source. Anti-scratch epoxy powder paint finish. Opal silicone closing reflector.

## **DE**

Dekoratives Hängebeleuchtungsgerät. Körper aus kalandriertem und extrudiertem Kohlenstoffstahl. Multichip LED-Leuchtmittel. Lackierung mit kratzfesten Epoxypulvern. Opalabdeckschirm aus Silikon.

## **FR**

Appareil décoratif en suspension. Corps en aluminium extrudé et calandré. Source de lumière en LED multichip. Finition de peinture en poudre époxy anti-rayures. Écran de fermeture en silicone opale.

## **RU**

Декоративный подвесной светильник. Корпус из экструдированного каландрированного алюминия. Источник света мульткристальный СИД. Покрытие устойчивым к царапинам эпоксидным порошком. Закрывающий экран выполнен из матового силикона.

*Lookup*



# CIRCO

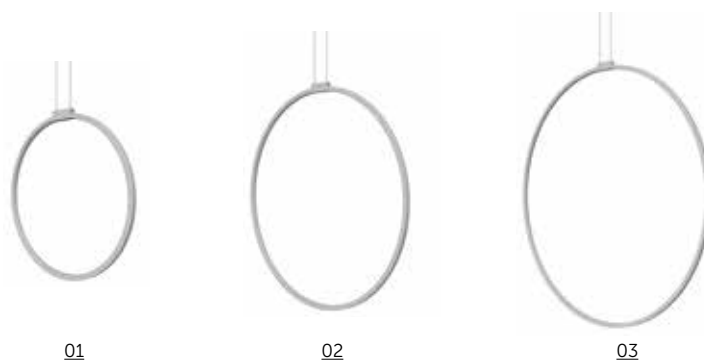

## CIRCO

Code	Size	Lumen	Watt	K	Beam angle	Driver Type	Driver no.	Colour
YCI32W	01	1380	22	W	D	ON/OFF	1	○
YCI48W	02	2080	33	W	D	ON/OFF	1	○
YCI64W	03	2770	44	W	D	ON/OFF	1	○

## ○ CIRCO COLOUR SELECTION

- **SB** | Silver Bombalai
- **BL** | Bronze Lario
- **RR** | Rust Rame
- **BF** | Beige Futuna
- **WI** | White Irazu
- **GK** | Gold Karkar
- **BT** | Blue Telica
- **BLL** | Black Lava

## CIRCO BEAM ANGLE | DIMENSIONS

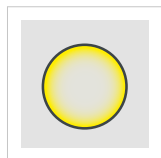

Size	X [mm]	Y [mm]	Z [mm]	Kg
<b>01</b>	∅ 325	12	Max 2000	0,5
<b>02</b>	∅ 485	12	Max 2000	0,7
<b>03</b>	∅ 645	12	Max 2000	0,9

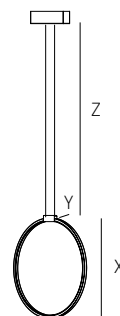

## CIRCO ACCESSORIES

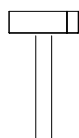

### INCLUDED

- Rose ceiling for brick installation
- Rose ceiling dimensions 185 x 27 x H 67 mm
- 2 suspension cables, length: 2 mt





# Olimpia

96  
97

# Olimpia

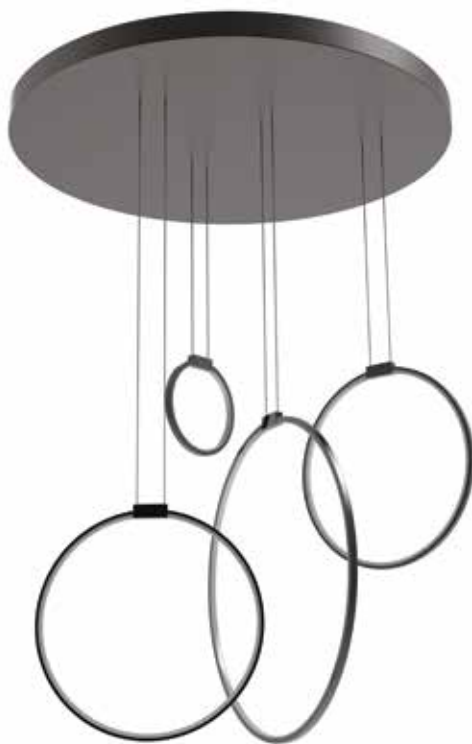

Suspension



On request

## IT

Apparecchio decorativo per installazione a sospensione. Base superiore in acciaio al carbonio. Sospensioni in alluminio estruso calandrato. Sorgente luminosa LED multichip. Verniciatura con polveri epossidiche antigraffio. Schermo di chiusura in silicone opale.

## ES

Luminaria decorativa de suspensión. Base superior en acero al carbono. Suspensión en aluminio extruido calandrado. Fuente de iluminación LED multichip. Recubierta con polvo epoxi anti-rayado. Difusor de silicona opal.

## EN

Decorative suspension lighting fitting. Carbon steel upper base. Calandered extruded aluminum suspensions. Multichip LED lighting source. Anti-scratch epoxy powder paint finish. Opal silicone closing reflector.

## DE

Dekoratives Hängebeleuchtungsgerät. Obere Basis aus Kohlenstoffstahl. Suspensionen aus extrudiertem Aluminium. Multichip LED-Leuchtmittel. Lackierung mit kratzfesten Epoxypulvern. Abdeckschirm aus opalem Silikon.

## FR

Appareil décoratif en suspension. Base supérieure en acier au carbone. Suspension en aluminium extrudé et calandré. Source de lumière en LED multichip. Finition de peinture en poudre époxy anti-rayures. Écran de fermeture en silicone opale.

## RU

Декоративный подвесной светильник. Верхнее основание из прессованной углеродистой стали. Подвески из экструдированного каландрированного алюминия. Источник света мультикристальный СИД. Покрытие устойчивым к царапинам эпоксидным порошком. Закрывающий экран выполнен из матового силикона.

# OLIMPIA

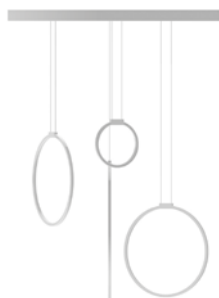

## OLIMPIA





Code	Size	Lumen	Watt	K	Beam angle	Driver Type	Driver no.	Colour
YOL58W	01	5530	88	W	D	ON/OFF	1	○

## ○ OLIMPIA COLOUR SELECTION

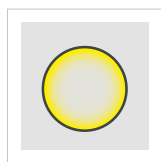
- **SB** | Silver Bombalai
- **BL** | Bronze Lario
- **RR** | Rust Rame
- **BF** | Beige Futuna
- **WI** | White Irazu
- **GK** | Gold Karkar
- **BT** | Blue Telica
- **BLL** | Black Lava

## OLIMPIA BEAM ANGLE | DIMENSIONS



Size	X (mm)	Y (mm)	Z (mm)	Kg
<b>01</b>	ø 750	*	max 2000	5
* Y (mm):				
				
1= ø 165	2= ø 325	3= ø 325	4= ø 485	

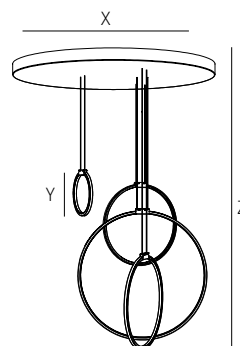

98  
99

## OLIMPIA SPECIAL FEATURES

- On request: special configuration to be agreed with technical offices





# Cibra



Suspension

Wall

Ceiling mounted



On request

## IT

Apparecchio decorativo per installazione a sospensione, parete e soffitto. Corpo diffusore in policarbonato trasparente. Riflettore in alluminio con chiusura in policarbonato microprismato. Terminali di chiusura in alluminio torniti. Sorgente luminosa LED multichip.

## ES

Luminaria decorativa de suspensión, pared, techo. Cuerpo difusor transparente de policarbonato. Reflector de aluminio con terminación de policarbonato microprismático. Tapas de aluminio torneado. Fuente de luz LED multichip.

## EN

Decorative suspension, ceiling and wall mounted lighting fitting. Transparent polycarbonate diffuser body Aluminium reflector with microprismatic polycarbonate closure. Turned aluminium end covers. Multichip LED lighting source.

## DE

Dekoratives Hänge-, Decken- und Wandbeleuchtungsgerät. Diffusorkörper aus transparentem Polycarbonat. Aluminium Reflektor mit Mikroprismenverschluss aus Polycarbonat. Endkappen aus gedrehtem Aluminium. Multichip LED-Leuchtmittel.

## FR

Appareil décoratif en suspension, au plafond, au mur. Corps diffusant en polycarbonate transparent. Réflecteur en aluminium avec fermeture en polycarbonate micro prismatique. Terminaux de fermeture en aluminium tourné. Source lumineuse LED multichip.

## RU

Декоративный подвесной, настенный и потолочный светильник. Корпус-диффузор выполнен из прозрачного поликарбоната. Алюминиевый рефлектор с закрытием из микропризматического поликарбоната. Окантовочные профили из формованного алюминия. Источник света мультикристалльный СИД.

LookUp



# LIBRA



## LIBRA VARIO *KELVIN*

Code	Size	Lumen	Watt	K	Beam angle	Driver Type	Driver no.	Colour
YLI11VK	01	5600	43	Vario	D	ON/OFF	1	○
YLI15VK	02	7450	57	Vario	D	ON/OFF	1	○

## LIBRA

Code	Size	Lumen	Watt	K	Beam angle	Driver Type	Driver no.	Colour
YLI11W	01	5600	43	W	D	ON/OFF	1	○
YLI15W	02	7450	57	W	D	ON/OFF	1	○

## ○ LIBRA COLOUR SELECTION

- **SB** | Silver Bombalai
- **BL** | Bronze Lario
- **RR** | Rust Rame
- **BF** | Beige Futuna
- **WI** | White Irazu
- **GK** | Gold Karkar
- **BT** | Blue Telica
- **BLL** | Black Lava

## LIBRA BEAM ANGLE | DIMENSIONS

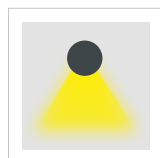

Size	X [mm]	Y [mm]	Z [mm]	Kg
<b>01</b>	1210	ø 83	ø 89	3,1
<b>02</b>	1590	ø 83	ø 89	3,8

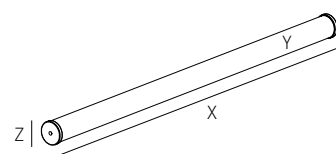

## LIBRA ACCESSORIES

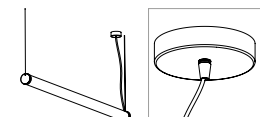

KIT YKT10207

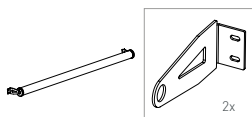

KIT YKT10209S

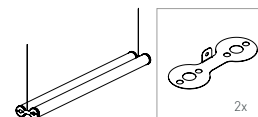

KIT YKT10209D

### NOT INCLUDED

- Order code: **YKT10207** | Rose ceiling for suspension installation Ø 60 mm - Height (30 mm) | 2 suspension cables, length: 2 mt
- Order code: **YKT10209S** | Bracket for wall/ceiling mounting system
- Order code: **YKT10209D** | Bracket for double suspensions

## LIBRA SPECIAL FEATURES

- Special continuous line configuration to be agreed with the technical office



*Lookup*



Opalia

# Opalia i



Suspension



On request

## IT

Apparecchio decorativo per installazione a sospensione. Corpo diffusore in policarbonato opale. Terminali di chiusura in alluminio torniti. Sorgente luminosa LED multichip.

## EN

Decorative suspension lighting fitting. Opal polycarbonate diffuser body. Turned aluminum end covers. Multichip LED light source.

## FR

Appareil décoratif en suspension. Corps diffusant en polycarbonate opale. Terminaux de fermeture en aluminium tourné. Source lumineuse LED multichip.

## ES

Luminaria decorativa de suspensión. Cuerpo difusor de policarbonato opal. Tapas de aluminio torneado. Fuente de luz LED multichip.

## DE

Dekoratives Hängebeleuchtungsgerät. Diffusorkörper aus Opalpolycarbonat. Endkappen aus gedrehtem Aluminium. Multichip LED-Leuchtmittel.

## RU

Декоративный подвесной светильник. Корпус-диффузор из матового поликарбоната. Окантовочные профили из формованного алюминия. Источник света мульткристальный СИД.

# OPALIA i

01



02



## OPALIA i VARIO *KELVIN*

Code	Size	Lumen	Watt	K	Beam angle	Driver Type	Driver no.	Colour
YOPI11VK	01	4620	58	Vario	D	ON/OFF	1	○
YOPI15VK	02	6300	79	Vario	D	ON/OFF	1	○

## OPALIA i

Code	Size	Lumen	Watt	K	Beam angle	Driver Type	Driver no.	Colour
YOPI11W	01	4620	58	W	D	ON/OFF	1	○
YOPI15W	02	6300	79	W	D	ON/OFF	1	○

## ○ OPALIA i COLOUR SELECTION

● **SB** | Silver Bombalai

● **BL** | Bronze Lario

● **RR** | Rust Rame

● **BF** | Beige Futuna

● **WI** | White Irazu

● **GK** | Gold Karkar

● **BT** | Blue Telica

● **BLL** | Black Lava

106  
107

## OPALIA i BEAM ANGLE | DIMENSIONS

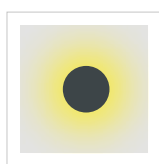

Size	X [mm]	Y [mm]	Z [mm]	Kg
01	1210	ø 83	ø 89	3,6
02	1590	ø 83	ø 89	4,5

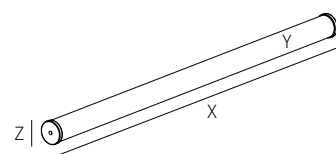

## OPALIA i ACCESSORIES



### INCLUDED

- Rose ceiling for installation with built in driver for ceiling panel
- Ø Rose ceiling 70 mm |  60 mm
- 2 suspension cables, lenght: 2 mt

# Opalia C



Suspension



On request

## IT

Apparecchio decorativo per installazione a sospensione. Corpo diffusore in policarbonato opale. Terminali di chiusura in alluminio torniti. Sorgente luminosa LED multichip.

## EN

Decorative suspension lighting fitting. Opal polycarbonate diffuser body. Turned aluminum end covers. Multichip LED light source.

## FR

Appareil décoratif en suspension. Corps diffusant en polycarbonate opale. Terminaux de fermeture en aluminium tourné. Source lumineuse LED multichip.

## ES

Luminaria decorativa de suspensión. Cuerpo difusor de policarbonato opal. Tapas de aluminio torneado. Fuente de luz LED multichip.

## DE

Dekoratives Hängebeleuchtungsgerät. Diffusorkörper aus Opalpolycarbonat. Endkappen aus gedrehtem Aluminium. Multichip LED-Leuchtmittel.

## RU

Декоративный подвесной светильник. Корпус-диффузор из матового поликарбоната. Окантовочные профили из формованного алюминия. Источник света мульткристальный СИД.

# OPALIA L

01



02



## OPALIA L VARIO *KELVIN*

Code	Size	Lumen	Watt	K	Beam angle	Driver Type	Driver no.	Colour
YOPL11VK	01	4620	58	Vario	D	ON/OFF	1	○
YOPL15VK	02	6300	79	Vario	D	ON/OFF	1	○

## OPALIA L

Code	Size	Lumen	Watt	K	Beam angle	Driver Type	Driver no.	Colour
YOPL11W	01	4620	58	W	D	ON/OFF	1	○
YOPL15W	02	6300	79	W	D	ON/OFF	1	○

## ○ OPALIA L COLOUR SELECTION

● **SB** | Silver Bombalai

● **BL** | Bronze Lario

● **RR** | Rust Rame

● **BF** | Beige Futuna

● **WI** | White Irazu

● **GK** | Gold Karkar

● **BT** | Blue Telica

● **BLL** | Black Lava

108  
109

## OPALIA L BEAM ANGLE | DIMENSIONS

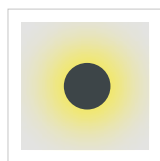

Size	X [mm]	Y [mm]	Z [mm]	Kg
<b>01</b>	1210	ø 83	ø 89	4,6
<b>02</b>	1590	ø 83	ø 89	6,0

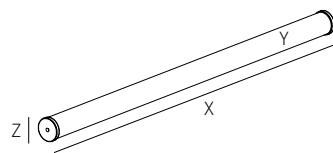

## OPALIA L ACCESSORIES

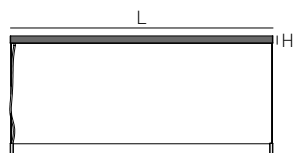

### INCLUDED

- Rose ceiling for brick installation
- Length (1210 mm - 1590 mm) | Height (45 mm)
- 2 suspension cables, length: 2 mt







# Boleerino

110  
111

# Belenine



## Suspension



On request

### IT

Apparecchio decorativo per installazione a sospensione. Corpo in alluminio tornito, Sorgente luminosa LED multichip. Verniciatura con polveri epossidiche antigraffio. Schermo di chiusura in policarbonato opale.

### EN

Decorative suspension lighting fitting. Turned aluminum body. Multichip LED light source. Anti-scratch epoxy powder paint finish. Opal polycarbonate closing reflector.

### FR

Appareil décoratif en suspension Corps en aluminium tourné. Source lumineux LED multichip. Finition de peinture en poudre époxy anti-rayures. Écran de fermeture en silicone opale.

### ES

Luminaria decorativa de suspensión. Cuerpo en aluminio torneado. Fuente de iluminación LED multichip. Recubierta con polvo epoxi anti-rayado. Difusor de policarbonato opal.

### DE

Dekoratives Hängebeleuchtungsgerät. Körper aus gedrehtem Aluminium. Multichip LED-Leuchtmittel. Lackierung mit kratzfesten Epoxypulvern. Abdeckschirm aus opalem Silikon.

### RU

Декоративный подвесной светильник. Корпус из формованного алюминия. Источник света мульткристальный СИД. Покрытие устойчивым к царапинам эпоксидным порошком. Закрывающий экран выполнен из матового поликарбоната.

# BOLERINO



## BOLERINO VARIO **LUMEN** | VARIO **KELVIN**

Code	Size	Vario Lumen	Watt	K	Beam angle	Driver Type	Driver no.	Colour
YBLN20VKL	01	920   1370   1830	10   15   20	Vario	D	ON/OFF	1	○

## BOLERINO

Code	Size	Lumen	Watt	K	Beam angle	Driver Type	Driver no.	Colour
YBLN16W	01	1500	16	W	D	ON/OFF	1	○
YBLN23W	01	2140	23	W	D	ON/OFF	1	○
YBLN30W	01	2780	30	W	D	ON/OFF	1	○
YBLN39W	01	3630	39	W	D	ON/OFF	1	○

## ○ BOLERINO COLOUR SELECTION

- **SB** | Silver Bombalai
- **BL** | Bronze Lario
- **RR** | Rust Rame
- **BF** | Beige Futuna
- **WI** | White Irazu
- **GK** | Gold Karkar
- **BT** | Blue Telica
- **BLL** | Black Lava

112  
113

## BOLERINO BEAM ANGLE | DIMENSIONS



Size	X (mm)	Z (mm)	Kg
01	ø 300	90	3,10

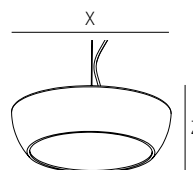

## BOLERINO ACCESSORIES

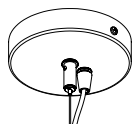

**INCLUDED**

- Rose ceiling for brick installation
- Ø Rose ceiling 120 mm | Height (25 mm)
- Suspension cable, lenght: 2 mt





wall





Alboa

# Alba



Wall Mounted



## IT

Apparecchio decorativo per installazione a parete. Corpo in alluminio estruso calandrato. Sorgente luminosa LED multichip. Verniciatura con polveri epossidiche antigraffio. Schermo di chiusura in silicone opalino.

## EN

Decorative lighting fitting for wall installation. Extruded and calendered aluminum body. Multichip LED lighting source. Anti-scratch epoxy powder paint finish. Opal silicone closing reflector.

## FR

Appareils décoratif pour l'installation sur le mur. Corps en aluminium extrudé et calandré. Source de lumière en LED multichip. Finition de peinture en poudre époxy anti-rayures. Écran de fermeture en silicone opale.

## ES

Luminaria decorativa para instalación en pared. Cuerpo de aluminio extruido y calandrado. Fuente de iluminación LED multichip. Recubierta con polvo epoxi anti-rayado. Difusor de silicona opal.

## DE

Dekoratives Wandbeleuchtungsgerät. Extrudierter und kalandrierter Aluminiumkörper. Multichip LED-Leuchtmittel. Lackierung mit kratzfesten Epoxypulvern. Abdeckschirm aus opalem Silikon.

## RU

Декоративный настенный светильник. Корпус из экструдированного алюминия calandrato. Источник света мульткристальный СИД. Покрытие устойчивым к царапинам эпоксидным порошком. Закрывающий экран выполнен из матового силикона.



# ALBA



## ALBA

Code	Size	Lumen	Watt	K	Beam angle	Driver Type	Driver no.	Colour
YAL16W	01	690	11	W	D	ON/OFF	1	○

## ○ ALBA COLOUR SELECTION

- **SB** | Silver Bombalai
- **BL** | Bronze Lario
- **RR** | Rust Rame
- **BF** | Beige Futuna
- **WI** | White Irazu
- **GK** | Gold Karkar
- **BT** | Blue Telica
- **BLL** | Black Lava

## ALBA BEAM ANGLE | DIMENSIONS

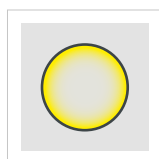

Size	X (mm)	Y (mm)	Z (mm)	Kg
<b>A</b>	Ø 165	12	250	0,6

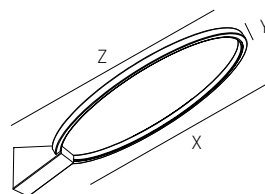

118  
119





Tink

# Tink



Wall Mounted

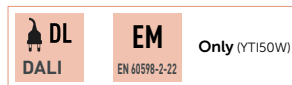

On request

## IT

Apparecchio decorativo per installazione a parete. Corpo in acciaio al carbonio pressopiegato. Sorgente luminosa LED multichip. Verniciatura con polveri epossidiche antigraffio. Schermo di chiusura in policarbonato opalino.

## EN

Decorative lighting fitting for wall installation. Bent carbon steel body. Multichip LED lighting source. Anti-scratch epoxy powder paint finish. Opal polycarbonate closing reflector.

## FR

Appareils décoratif pour l'installation sur le mur. Corps en acier au carbone courbé. Source de lumière en LED multichip. Finition de peinture en poudre époxy anti-rayures. Écran de fermeture en polycarbonate opale.

## ES

Luminaria decorativa para instalación en pared. Cuerpo de acero al carbono plegado. Fuente de iluminación LED multichip. Recubierta con polvo epoxi anti-rayado. Difusor de policarbonato opal.

## DE

Dekoratives Wandbeleuchtungsgerät. Körper aus pressgeformtem Kohlenstoffstahl. Multichip LED-Leuchtmittel. Lackierung mit kratzfesten Epoxypulvern. Abdeckschirm aus opalem Polycarbonat.

## RU

Декоративный настенный светильник. Корпус из прессованной углеродистой стали. Источник света мульткристальный СИД. Покрытие устойчивым к царапинам эпоксидным порошком. Закрывающий экран выполнен из матового поликарбоната.

Lookup



01



02



03

## TINK VARIO LUMEN | VARIO KELVIN

Code	Size	Vario Lumen	Watt	K	Beam angle	Driver Type	Driver no.	Colour
YTI22VKL	01	1070   1600   2140	12   17   23	Vario	D	ON/OFF	1	○
YTI30VKL	02	2140   3200   4270	23   35   46	Vario	D	ON/OFF	2	○
YTI50VKL	03	4270   6400   8530	46   69   92	Vario	D	ON/OFF	4	○

## TINK

Code	Size	Lumen	Watt	K	Beam angle	Driver Type	Driver no.	Colour
YTI22W	01	2780	30	W	D	ON/OFF	1	○
YTI30W	02	5550	60	W	D	ON/OFF	2	○
YTI50W	03	11090	120	W	D	ON/OFF	4	○

## ○ TINK COLOUR SELECTION

- **SB** | Silver Bombalai
- **BL** | Bronze Lario
- **RR** | Rust Rame
- **BF** | Beige Futuna
- **WI** | White Irazu
- **GK** | Gold Karkar
- **BT** | Blue Telica
- **BLL** | Black Lava

## TINK BEAM ANGLE | DIMENSIONS



Size	X [mm]	Y [mm]	Z [mm]	Kg
<b>01</b>	220	220	70	1,6
<b>02</b>	300	300	85	2,2
<b>03</b>	500	500	130	3,7

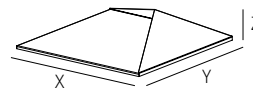





# Faces M

124  
125

# Facer M



Wall Mounted



## IT

Apparecchio decorativo per installazione a parete. Corpo in acciaio al carbonio pressopiegato. Frontale intercambiabile con fissaggio magnetico. Sorgente luminosa LED multichip. Verniciatura con polveri epossidiche antigraffio. Schermo di chiusura in policarbonato opalino.

## ES

Luminaria decorativa para instalación en pared. Cuerpo de acero al carbono plegado. Intercambiable con sistema de fijación magnético. Fuente de iluminación LED multichip. Recubierta con polvo epoxi anti-rayado. Difusor de policarbonato opal.

## EN

Decorative lighting fitting for wall installation. Bent carbon steel body. Interchangeable front with magnetic fixing. Multichip LED lighting source. Anti-scratch epoxy powder paint finish. Opal polycarbonate closing reflector.

## DE

Dekoratives Wandbeleuchtungsgerät. Körper aus pressgeformtem Kohlenstoffstahl. Auswechselbare Vorderer mit magnetischer Befestigung. Multichip LED-Leuchtmittel. Lackierung mit kratzfesten Epoxypulvern. Abdeckschirm aus opalem Polycarbonat.

## FR

Appareils décoratif pour l'installation sur le mur. Corps en acier au carbone courbé. Avant interchangeable avec fixation magnétique. Source de lumière en LED multichip. Finition de peinture en poudre époxy anti-rayures. Écran de fermeture en polycarbonate opale.

## RU

Декоративный настенный светильник. Корпус из прессованной углеродистой стали. Лицевая сторона с магнитным креплением. Источник света мультикристалльный СИД. Покрытие устойчивым к царапинам эпоксидным порошком. Закрывающий экран выполнен из матового поликарбоната.



# FACES M



## FACES M BASE VARIO LUMEN | VARIO KELVIN

Code	Size	Lumen	Watt	K	Beam angle	Driver Type	Driver no.	Colour
YFAM14VKL	01	1280   1920   2560	14   21   28	W	D	ON/OFF	1	○

## FACES M MAGNETIC COVER

Code	Size	●	●	●	●	●	●	●	●
YFAFM145	01	SB	BL	RR	BF	WI	GK	BT	BLL

## ○ FACES M COLOUR SELECTION

- SB | Silver Bombalai
- BL | Bronze Lario
- RR | Rust Rame
- BF | Beige Futuna
- WI | White Irazu
- GK | Gold Karkar
- BT | Blue Telica
- BLL | Black Lava

126  
127

## FACES M BEAM ANGLE | DIMENSIONS



Size	X (mm)	Y (mm)	Z (mm)	Kg
A	145	600	115	1,8

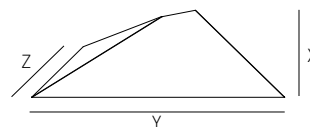





# Calea

# Calea



Wall Mounted

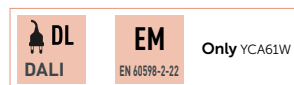

On request

## IT

Apparecchio decorativo per installazione a parete. Corpo in acciaio al carbonio pressopiegato. Sorgente luminosa LED multichip. Verniciatura con polveri epossidiche antigraffio. Schermo di chiusura in policarbonato microprismato.

## ES

Luminaria decorativa para instalación en pared. Cuerpo de acero al carbono plegado. Fuente de iluminación LED multichip. Recubierta con polvo epoxi anti-rayado. Difusor de policarbonato microprismático.

## EN

Decorative lighting fitting for wall installation Bent carbon steel body. Multichip LED lighting source. Anti-scratch epoxy powder paint finish. Microprismatic polycarbonate closing reflector.

## DE

Dekoratives Wandbeleuchtungsgerät. Körper aus pressgeformtem Kohlenstoffstahl. Multichip LED-Leuchtmittel. Lackierung mit kratzfesten Epoxypulvern. Abdeckschirm aus Mikroprismen-Polycarbonat.

## FR

Appareils décoratif pour l'installation sur le mur. Corps en acier au carbone courbé. Source de lumière en LED multichip. Finition de peinture en poudre époxy anti-rayures. Écran de fermeture en polycarbonate microprismatique.

## RU

Декоративный настенный светильник. Корпус из прессованной углеродистой стали. Источник света мульткристалльный СИД. Покрытие устойчивым к царапинам эпоксидным порошком. Закрывающий экран выполнен из прозрачного поликарбоната.

# CALEA



01



02



03

## CALEA VARIO **LUMEN** | VARIO **KELVIN**

Code	Size	Vario Lumen	Watt	K	Beam angle	Driver Type	Driver no.	Colour
YCA21VKL	01	2790   4180   5570	26   40   53	Vario	D	ON/OFF	1	○
YCA41VKL	02	5570   8360   11140	53   79   106	Vario	D	ON/OFF	2	○
YCA61VKL	03	8360   12530   16710	79   119   158	Vario	D	ON/OFF	3	○

## CALEA

Code	Size	Lumen	Watt	K	Beam angle	Driver Type	Driver no.	Colour
YCA21W	01	5570	53	W	D	ON/OFF	1	○
YCA41W	02	11140	106	W	D	ON/OFF	2	○
YCA61W	03	16710	158	W	D	ON/OFF	3	○

## ○ CALEA COLOUR SELECTION

- **SB** | Silver Bombalai
- **BL** | Bronze Lario
- **RR** | Rust Rame
- **BF** | Beige Futuna
- **WI** | White Irazu
- **GK** | Gold Karkar
- **BT** | Blue Telica
- **BLL** | Black Lava

## CALEA BEAM ANGLE | DIMENSIONS



Size	X (mm)	Y (mm)	Z (mm)	J (mm)	K (mm)	Kg
<b>01</b>	210	183	183	26	26	2,7
<b>02</b>	410	183	183	26	26	5,4
<b>03</b>	610	183	183	26	26	8,2

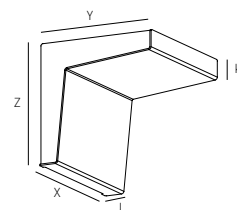





ZOE

# Zee M



2700K | 3350K | 4000K



Wall Mounted



On request

## IT

Apparecchio decorativo per installazione a parete composto da:

- Base portacablaggio con sorgente luminosa LED multichip e schermo di chiusura in policarbonato opalino
- Frontale in acciaio al carbonio pressopiegato intercambiabile con fissaggio magnetico. Verniciatura con polveri epossidiche antigraffio.

## ES

Luminaria decorativa para instalación en pared compuesta de:

- Base soporte de cableado con fuente de iluminación LED multichip y difusor de policarbonato opal.
- Panel frontal de carbono plegado a presión intercambiable con sistema de fijación magnético. Recubierta con polvo epoxi anti-rayado.

## EN

Decorative lighting fitting for wall installation consisting of:

- Gear plate with multichip led lighting source and opal polycarbonate closing reflector.
- Interchangeable bent carbon steel front with magnetic fixing. Anti-scratch epoxy powder paint finish.

## DE

Dekoratives Wandbeleuchtungsgerät zusammengesetzt aus:

- Verdrahtungsbasis mit multichip LED-Leuchtmittel und Abdeckschirm aus opalem Polycarbonat.
- Auswechselbare Vordere aus pressgeformtem Kohlenstoffstahl mit magnetischer Befestigung. Lackierung mit kratzfesten Epoxypulvern.

## FR

Appareils décoratif pour l'installation sur le mur consistant en:

- Socle de câblage avec source lumineuse LED et écran de fermeture en polycarbonate opale.
- Avant en acier au carbon interchangeable avec fixation magnetique. Finition de peinture en poudre epoxy anti-rayures.

## RU

Декоративный настенный светильник, состоящий из:

- Основание с кабельной проводкой с источником света мульткристалльный СИД и закрывающий экран выполнен из матового поликарбоната.
- Лицевая сторона из прессованной углеродистой стали с магнитным креплением. Покрытие устойчивым к царапинам эпоксидным порошком.

LookUp



# ZOE M



## ZOE M BASE VARIO LUMEN | VARIO KELVIN

Code	Size	Vario Lumen	Watt	K	Beam angle	Driver Type	Driver no.	Colour
DIRECT + INDIRECT EMISSION (D+I)								
YZOM23VKL	01	1280   1920   2560	14   21   28	Vario	D	ON/OFF	1	○
YZOM40VKL	02	2560   3840   5120	28   42   55	Vario	D	ON/OFF	1	○
YZOM60VKL	03	3840   5760   7680	42   62   83	Vario	D	ON/OFF	1	○

## ZOE M MAGNETIC COVER

Code	Size	●	●	●	●	●	●	●	●
YZOFM225	01	SB	BL	RR	BF	WI	GK	BT	BLL
YZOFM395	02	SB	BL	RR	BF	WI	GK	BT	BLL
YZOFM595	03	SB	BL	RR	BF	WI	GK	BT	BLL

## ○ ZOE M COLOUR SELECTION

- SB | Silver Bombalai
- BL | Bronze Lario
- RR | Rust Rame
- BF | Beige Futuna
- WI | White Irazu
- GK | Gold Karkar
- BT | Blue Telica
- BLL | Black Lava

## ZOE M BEAM ANGLE | DIMENSIONS

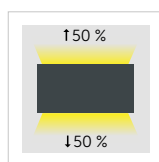

Size	X (mm)	Y (mm)	Z (mm)	Kg
01	70	225	115	1,1
02	70	395	115	1,8
03	70	595	115	2,7

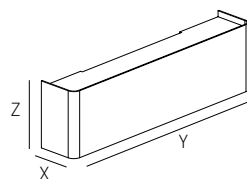

# Zae



Wall Mounted

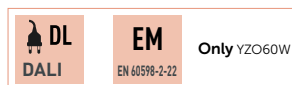

On request

## IT

Apparecchio decorativo per installazione a parete. Corpo in acciaio al carbonio pressopiegato. Sorgente luminosa LED multichip. Verniciatura con polveri epossidiche antigraffio. Schermo di chiusura in policarbonato opalino.

## EN

Decorative lighting fitting for wall installation. Bent carbon steel body. Multichip LED lighting source. Anti-scratch epoxy powder paint finish. Opal polycarbonate closing reflector.

## FR

Appareils décoratif pour l'installation sur le mur. Corps en acier au carbone courbé. Source de lumière en LED multichip. Finition de peinture en poudre époxy anti-rayures. Écran de fermeture en polycarbonate opale.

## ES

Luminaria decorativa para instalación en pared. Cuerpo de acero al carbono plegado. Fuente de iluminación LED multichip. Recubierta con polvo epoxi anti-rayado. Difusor de policarbonato opal.

## DE

Dekoratives Wandbeleuchtungsgerät. Körper aus pressgeformtem Kohlenstoffstahl. Multichip LED-Leuchtmittel. Lackierung mit kratzfesten Epoxypulvern. Abdeckschirm aus opalem Polycarbonat.

## RU

Декоративный настенный светильник. Корпус из прессованной углеродистой стали. Источник света мульткристальный СИД. Покрытие устойчивым к царапинам эпоксидным порошком. Закрывающий экран выполнен из матового поликарбоната.

Lookup



## ZOE

Code	Size	Lumen	Watt	K	Beam angle	Driver Type	Driver no.	Colour
DIRECT + INDIRECT EMISSION (D+I)								
YZO23W	01	2560	28	W	D	ON/OFF	1	○
YZO40W	02	5120	55	W	D	ON/OFF	1	○
YZO60W	03	7680	83	W	D	ON/OFF	1	○

## ○ ZOE COLOUR SELECTION

- **SB** | Silver Bombalai
- **BL** | Bronze Lario
- **RR** | Rust Rame
- **BF** | Beige Futuna
- **WI** | White Irazu
- **GK** | Gold Karkar
- **BT** | Blue Telica
- **BLL** | Black Lava

## ZOE BEAM ANGLE | DIMENSIONS

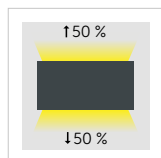

Size	X (mm)	Y (mm)	Z (mm)	Kg
<b>01</b>	70	225	115	1,1
<b>02</b>	70	395	115	1,8
<b>03</b>	70	595	115	2,7

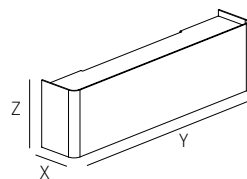





138  
139

Talé

# Tali M



Wall Mounted



On request

## IT

Apparecchio decorativo per installazione a parete composto da:

- Base portacablaggio con sorgente luminosa LED multichip e schermo di chiusura in policarbonato opalino
- Frontale in acciaio al carbonio pressopiegato intercambiabile con fissaggio magnetico. Verniciatura con polveri epossidiche antigraffio.

## ES

Luminaria decorativa para instalación en pared compuesta de:

- Base soporte de cableado con fuente de iluminación LED multichip y difusor de policarbonato opal.
- Panel frontal de carbono plegado a presión intercambiable con sistema de fijación magnético. Recubierta con polvo epoxi anti-rayado.

## EN

Decorative lighting fitting for wall installation consisting of:

- Gear plate with multichip led lighting source and opal polycarbonate closing reflector.
- Interchangeable bent carbon steel front with magnetic fixing. Anti-scratch epoxy powder paint finish.

## DE

Dekoratives Wandbeleuchtungsgerät zusammengesetzt aus:

- Verdrahtungsbasis mit multichip LED-Leuchtmittel und Abdeckschirm aus opalem Polycarbonat.
- Auswechselbare Vordere aus pressgeformtem Kohlenstoffstahl mit magnetischer Befestigung. Lackierung mit kratzfesten Epoxypulvern.

## FR

Appareils décoratif pour l'installation sur le mur consistant en:

- Socle de câblage avec source lumineuse LED et écran de fermeture en polycarbonate opale.
- Avant en acier au carbon interchangeable avec fixation magnetique. Finition de peinture en poudre epoxy anti-rayures.

## RU

Декоративный настенный светильник, состоящий из:

- Основание с кабельной проводкой с источником света мульткристальный СИД и закрывающий экран выполнен из матового поликарбоната.
- Лицевая сторона из прессованной углеродистой стали заменяемая на магнитное крепление. Покрытие устойчивым к царапинам эпоксидным порошком.

# TALÈ M



## TALÈ M BASE VARIO **LUMEN** | VARIO **KELVIN**

Code	Size	Vario Lumen	Watt	K	Beam angle	Driver Type	Driver no.	Colour
DIRECT + INDIRECT EMISSION (D+I)								
YTAM14VKL	01	1220   1830   2440	13   20   26	Vario	D	ON/OFF	1	○
YTAM17VKL	02	1530   2290   3050	17   25   33	Vario	D	ON/OFF	1	○
YTAM32VKL	03	1830   2750   3660	20   30   40	Vario	D	ON/OFF	1	○

## TALÈ M **MAGNETIC COVER**

Code	Size	●	●	●	●	●	●	●	●
YTAFM145	01	SB	BL	RR	BF	WI	GK	BT	BLL
YTAFM175	02	SB	BL	RR	BF	WI	GK	BT	BLL
YTAFM325	03	SB	BL	RR	BF	WI	GK	BT	BLL

140  
141

## ○ TALÈ M COLOUR SELECTION

- SB | Silver Bombalai
- BL | Bronze Lario
- RR | Rust Rame
- BF | Beige Futuna
- WI | White Irazu
- GK | Gold Karkar
- BT | Blue Telica
- BLL | Black Lava

## TALÈ M BEAM ANGLE | DIMENSIONS

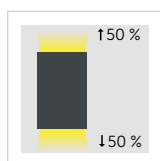

Size	X [mm]	Y [mm]	Z [mm]	Kg
01	85	120	145	1,0
02	85	120	175	1,3
03	125	180	325	2,5

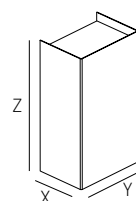

# Tali



Wall Mounted

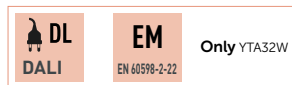

On request

## IT

Apparecchio decorativo per installazione a parete. Corpo in acciaio al carbonio pressopiegato. Sorgente luminosa LED multichip. Verniciatura con polveri epossidiche antigraffio. Schermo di chiusura in policarbonato opalino.

## EN

Decorative lighting fitting for wall installation. Bent carbon steel body. Multichip LED lighting source. Anti-scratch epoxy powder paint finish. Opal polycarbonate closing reflector.

## FR

Appareils décoratif pour l'installation sur le mur. Corps en acier au carbone courbé. Source de lumière en LED multichip. Finition de peinture en poudre époxy anti-rayures. Écran de fermeture en polycarbonate opale.

## ES

Luminaria decorativa para instalación en pared. Cuerpo de acero al carbono plegado. Fuente de iluminación LED multichip. Recubierta con polvo epoxi anti-rayado. Difusor de policarbonato opal.

## DE

Dekoratives Wandbeleuchtungsgerät. Körper aus pressgeformtem Kohlenstoffstahl. Multichip LED-Leuchtmittel. Lackierung mit kratzfesten Epoxypulvern. Abdeckschirm aus opalem Polycarbonat.

## RU

Декоративный настенный светильник. Корпус из пресованной углеродистой стали. Источник света мульткристальный СИД. Покрытие устойчивым к царапинам эпоксидным порошком. Закрывающий экран выполнен из матового поликарбоната.



# TALÈ



## TALÈ

Code	Size	Lumen	Watt	K	Beam angle	Driver Type	Driver no.	Colour
DIRECT + INDIRECT EMISSION (D+I)								
YTA14W	01	3410	37	W	D	ON/OFF	1	○
YTA17W	02	4270	46	W	D	ON/OFF	1	○
YTA32W	03	5120	55	W	D	ON/OFF	1	○

## ○ TALÈ COLOUR SELECTION

- **SB** | Silver Bombalai
- **BL** | Bronze Lario
- **RR** | Rust Rame
- **BF** | Beige Futuna
- **WI** | White Irazu
- **GK** | Gold Karkar
- **BT** | Blue Telica
- **BLL** | Black Lava

## TALÈ BEAM ANGLE | DIMENSIONS

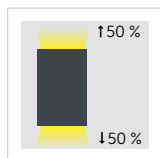

Size	X (mm)	Y (mm)	Z (mm)	Kg
<b>01</b>	85	120	145	1,0
<b>02</b>	85	120	175	1,3
<b>03</b>	125	180	325	2,5

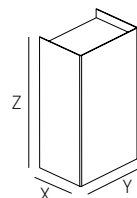





# Ester

144  
145

# Esten



Wall Mounted  
Ceiling Mounted



**5Y WARRANTY**  
5% FAILURE RATE

**60.000 h**  
LED LIFETIME L90B10



On request

## IT

Apparecchio decorativo per installazione a parete o plafone. Corpo in alluminio estruso. Sorgente luminosa LED multichip. Verniciatura con polveri epossidiche antigraffio. Schermo di chiusura in policarbonato opalino.

## ES

Luminaria decorativa para instalación en pared y techo. Cuerpo de aluminio extruido. Fuente de iluminación LED multichip. Recubierta con polvo epoxi anti-rayado. Difusor de policarbonato opal.

## EN

Decorative lighting fitting for wall or ceiling installation. Extruded aluminium body. Multichip LED lighting source. Anti-scratch epoxy powder paint finish. Opal polycarbonate closing reflector.

## DE

Dekoratives Wand- und Deckenbeleuchtungsgerät. Körper aus extrudiertem Aluminium. Multichip LED-Leuchtmittel. Lackierung mit kratzfesten Epoxypulvern. Abdeckschirm aus opalem Polycarbonat.

## FR

Appareils décoratif pour l'installation sur le mur ou plafond. Corps en aluminium extrudé. Source de lumière en LED multichip. Finition de peinture en poudre époxy anti-rayures. Écran de fermeture en polycarbonate opale.

## RU

Декоративный настенный либо потолочный светильник. Корпус из экструдированного алюминия. Источник света мульткристальный СИД. Покрытие устойчивым к царапинам эпоксидным порошком. Закрывающий экран выполнен из матового поликарбоната

# ESTER

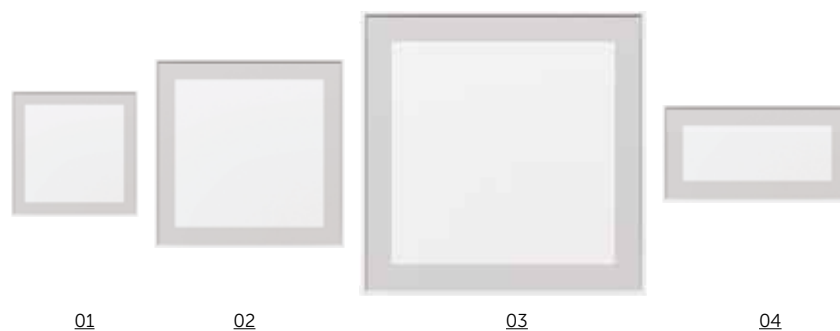

## ESTER VARIO *KELVIN*

Code	Size	Lumen	Watt	K	Beam angle	Driver Type	Driver no.	Colour
YES40VK	01	1280	14	Vario	D	ON/OFF	1	○
YES60VK	02	5120	55	Vario	D	ON/OFF	1	○
YES90VK	03	7680	83	Vario	D	ON/OFF	2	○
YES30VK	04	2560	28	Vario	D	ON/OFF	2	○

## ESTER

Code	Size	Lumen	Watt	K	Beam angle	Driver Type	Driver no.	Colour
YES40W	01	1280	14	W	D	ON/OFF	1	○
YES60W	02	5120	55	W	D	ON/OFF	1	○
YES90W	03	7680	83	W	D	ON/OFF	2	○
YES30W	04	2560	28	W	D	ON/OFF	2	○

146  
147

## ○ ESTER COLOUR SELECTION

- SB | Silver Bombalai
- BL | Bronze Lario
- RR | Rust Rame
- BF | Beige Futuna
- WI | White Irazu
- GK | Gold Karkar
- BT | Blue Telica
- BLL | Black Lava

## ESTER BEAM ANGLE | DIMENSIONS



Size	X [mm]	Y [mm]	Z [mm]	Kg
<b>01</b>	400	400	78	4,2
<b>02</b>	600	600	78	7,2
<b>03</b>	900	900	78	14,0
<b>04</b>	300	600	78	4,6

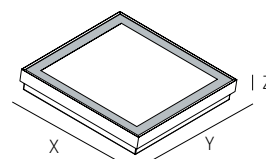





Duodu

# Dudu

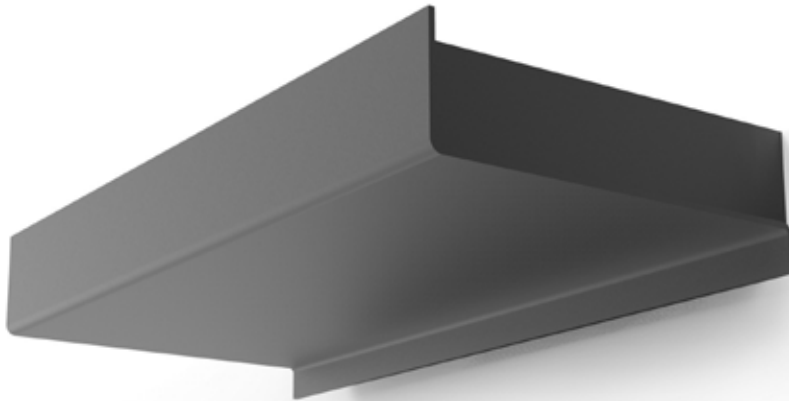

Wall Mounted



On request

## IT

Apparecchio decorativo per installazione a parete. Corpo in acciaio al carbonio pressopiegato. Sorgente luminosa LED multichip. Verniciatura con polveri epossidiche antigraffio. Schermo di chiusura in policarbonato opale.

## EN

Decorative lighting fitting for wall installation Bent carbon steel body. Multichip LED lighting source. Anti-scratch epoxy powder paint finish. Opal polycarbonate closing reflector.

## FR

Appareils décoratif pour l'installation sur le mur. Corps en acier au carbone courbé. Source de lumière en LED multichip. Finition de peinture en poudre époxy anti-rayures. Écran de fermeture en polycarbonate opale.

## ES

Luminaria decorativa para instalación en pared. Cuerpo de acero al carbono plegado. Fuente de iluminación LED multichip. Recubierta con polvo epoxi anti-rayado. Difusor de policarbonato opal.

## DE

Dekoratives Wandbeleuchtungsgerät. Körper aus pressgeformtem Kohlenstoffstahl Multichip LED-Leuchtmittel. Lackierung mit kratzfesten Epoxypulvern. Abdeckschirm aus opalem Polycarbonat.

## RU

Декоративный настенный светильник. Корпус из прессованной углеродистой стали. Источник света мульткристальный СИД. Покрытие устойчивым к царапинам эпоксидным порошком. Закрывающий экран выполнен из матового поликарбоната

Lookup





## DUDU VARIO *KELVIN*

Code	Size	Lumen	Watt	K	Beam angle	Driver Type	Driver no.	Colour
YDU23VK	01	2560	28	Vario	D	ON/OFF	1	○
YDU40VK	02	5120	55	Vario	D	ON/OFF	1	○
YDU60VK	03	7680	83	Vario	D	ON/OFF	1	○

## DUDU

Code	Size	Lumen	Watt	K	Beam angle	Driver Type	Driver no.	Colour
YDU23W	01	2560	28	W	D	ON/OFF	1	○
YDU40W	02	5120	55	W	D	ON/OFF	1	○
YDU60W	03	7680	83	W	D	ON/OFF	1	○

## ○ DUDU COLOUR SELECTION

- **SB** | Silver Bombalai
- **BL** | Bronze Lario
- **RR** | Rust Rame
- **BF** | Beige Futuna
- **WI** | White Irazu
- **GK** | Gold Karkar
- **BT** | Blue Telica
- **BLL** | Black Lava

## DUDU BEAM ANGLE | DIMENSIONS



Size	X (mm)	Y (mm)	Z (mm)	J (mm)	K (mm)	Kg
<b>01</b>	110	230	40	10	30	0,8
<b>02</b>	110	395	40	10	30	1,4
<b>03</b>	110	595	40	10	30	2,1

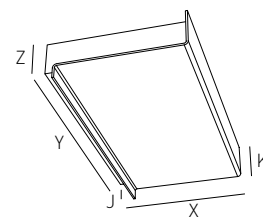



*Lookup*



DOSI

# Dari



Wall Mounted



On request

## IT

Apparecchio decorativo per installazione a parete. Corpo in acciaio al carbonio pressopiegato. Sorgente luminosa LED multichip. Verniciatura con polveri epossidiche antigraffio. Schermo di chiusura in policarbonato opale.

## EN

Decorative lighting fitting for wall installation Bent carbon steel body. Multichip LED lighting source. Anti-scratch epoxy powder paint finish. Opal polycarbonate closing reflector.

## FR

Appareils décoratif pour l'installation sur le mur. Corps en acier au carbone courbé. Source de lumière en LED multichip. Finition de peinture en poudre époxy anti-rayures. Écran de fermeture en polycarbonate opale.

## ES

Luminaria decorativa para instalación en pared. Cuerpo de acero al carbono plegado. Fuente de iluminación LED multichip. Recubierta con polvo epoxi anti-rayado. Difusor de policarbonato opal.

## DE

Dekoratives Wandbeleuchtungsgerät. Körper aus pressgeformtem Kohlenstoffstahl. Multichip LED-Leuchtmittel. Lackierung mit kratzfesten Epoxypulvern. Abdeckschirm aus opalem Polycarbonat.

## RU

Декоративный настенный светильник. Корпус из прессованной углеродистой стали. Источник света мульткристальный СИД. Покрытие устойчивым к царапинам эпоксидным порошком. Закрывающий экран выполнен из матового поликарбоната

Lookup



## DOSI VARIO *KELVIN*

Code	Size	Lumen	Watt	K	Beam angle	Driver Type	Driver no.	Colour
YDO23VK	01	2560	28	Vario	D	ON/OFF	1	○
YDO40VK	02	5120	55	Vario	D	ON/OFF	1	○
YDO60VK	03	7680	83	Vario	D	ON/OFF	1	○

## DOSI

Code	Size	Lumen	Watt	K	Beam angle	Driver Type	Driver no.	Colour
YDO23W	01	2560	28	W	D	ON/OFF	1	○
YDO40W	02	5120	55	W	D	ON/OFF	1	○
YDO60W	03	7680	83	W	D	ON/OFF	1	○

## ○ DOSI COLOUR SELECTION

- **SB** | Silver Bombalai
- **BL** | Bronze Lario
- **RR** | Rust Rame
- **BF** | Beige Futuna
- **WI** | White Irazu
- **GK** | Gold Karkar
- **BT** | Blue Telica
- **BLL** | Black Lava

## DOSI BEAM ANGLE | DIMENSIONS

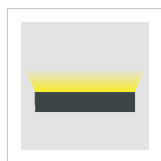

Size	X (mm)	Y (mm)	Z (mm)	K (mm)	Kg
<b>01</b>	110	230	30	40	0,8
<b>02</b>	110	395	30	40	1,4
<b>03</b>	110	595	30	40	2,1

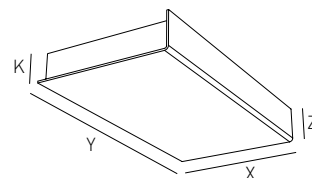



*Lookup*



Gina

# Gina



Wall Mounted



**5Y WARRANTY**  
5% FAILURE RATE

**60.000 h**  
LED LIFETIME L90B10

**DL**  
DALI

**EM**

EN 60598-2-22

Only YGI80W

On request

## IT

Apparecchio decorativo per installazione a parete. Corpo in alluminio estruso. Sorgente luminosa LED multichip. Verniciatura con polveri epossidiche antigraffio. Schermo di chiusura in policarbonato opale.

## EN

Decorative lighting fitting for wall installation. Extruded aluminium body. Multichip LED lighting source. Anti-scratch epoxy powder paint finish. Opal polycarbonate closing reflector.

## FR

Appareils décoratif pour l'installation sur le mur. Corps en aluminium extrudé. Source de lumière en LED multichip. Finition de peinture en poudre époxy anti-rayures. Écran de fermeture en polycarbonate opale.

## ES

Luminaria decorativa para instalación en pared. Cuerpo de aluminio extruido. Fuente de iluminación LED multichip. Recubierta con polvo epoxi anti-rayado. Difusor de policarbonato opal.

## DE

Dekoratives Wandbeleuchtungsgerät. Körper aus extrudiertem Aluminium. Multichip LED-Leuchtmittel. Lackierung mit kratzfesten Epoxypulvern. Abdeckschirm aus opalem Polycarbonat.

## RU

Декоративный настенный светильник. Корпус из экструдированного алюминия. Источник света мульткристальный СИД. Покрытие устойчивым к царапинам эпоксидным порошком. Закрывающий экран выполнен из матового поликарбоната.

Lookup



# GINA



## GINA

Code	Size	Lumen	Watt	K	Beam angle	Driver Type	Driver no.	Colour
DIRECT + INDIRECT EMISSION (D+I)								
YGI18W	01	580	9	W	D	ON/OFF	1	○
YGI41W	02	1100	12	W	D	ON/OFF	1	○
YGI80W	03	2200	24	W	D	ON/OFF	1	○

## ○ GINA COLOUR SELECTION

- **SB** | Silver Bombalai
- **BL** | Bronze Lario
- **RR** | Rust Rame
- **BF** | Beige Futuna
- **WI** | White Irazu
- **GK** | Gold Karkar
- **BT** | Blue Telica
- **BLL** | Black Lava

## GINA BEAM ANGLE | DIMENSIONS

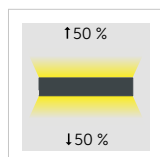

Size	X (mm)	Y (mm)	Z (mm)	K (mm)	J (mm)	Kg
<b>01</b>	110	180	45	30	80	0,6
<b>02</b>	110	410	45	30	80	1,4
<b>03</b>	110	800	45	30	80	2,4

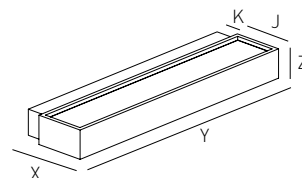

158  
159





Mali

# Mali



Wall Mounted



On request

## IT

Apparecchio decorativo per installazione a parete. Corpo in acciaio al carbonio calandrato e pressopiegato, cod (S) liscio, cod (AM) con feritoie. Sorgente luminosa LED multichip. Verniciatura con polveri epossidiche antigraffio. Schermo di chiusura in policarbonato opalino.

## ES

Luminaria decorativa para instalación en pared. Cuerpo de acero al carbono plegado y calandrado, código (S) con difusor liso, código (AM) con difusor radiado. Fuente de iluminación LED multichip. Recubierta con polvo epoxi anti-rayado. Difusor de policarbonato opal.

## EN

Decorative lighting fitting for wall installation. Bent and calendered carbon steel body, code (S) smooth, code (AM) with loopholes. Multichip LED lighting source. Anti-scratch epoxy powder paint finish. Opal polycarbonate closing reflector.

## DE

Dekoratives Wandbeleuchtungsgerät. Körper aus pressgeformtem und kalandriertem Kohlenstoffstahl, Kode (S) glatt, Kode (AM) mit Gittern. Multichip LED-Leuchtmittel. Lackierung mit kratzfesten Epoxypulvern. Abdeckschirm aus opalem Polycarbonat.

## FR

Appareils décoratif pour l'installation sur le mur. Corps en acier au carbone courbé et calandré, code (S) lisse, code (AM) avec persienne. Source de lumière en LED multichip. Finition de peinture en poudre époxy anti-rayures. Écran de fermeture en polycarbonate opale.

## RU

Декоративный настенный светильник. Корпус из экструдированного алюминия. Источник света мульткристальный СИД. Покрытие устойчивым к царапинам эпоксидным порошком. Закрывающий экран выполнен из матового поликарбоната.

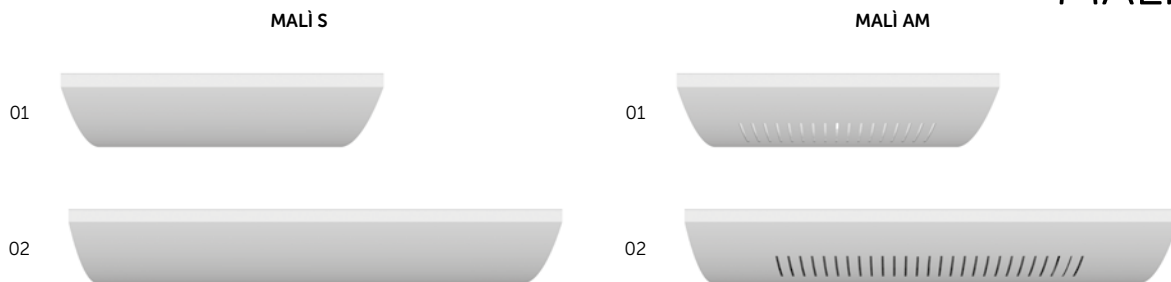

## MALÌ S

Code	Size	Lumen	Watt	K	Beam angle	Driver Type	Driver no.	Colour
YMAS36W	01	2440	23	W	D	ON/OFF	1	○
YMAS60W	02	3510	33	W	D	ON/OFF	1	○

## MALÌ AM

Code	Size	Lumen	Watt	K	Beam angle	Driver Type	Driver no.	Colour
YMAM36W	01	2440	23	W	D	ON/OFF	x	○
YMAM60W	02	3510	33	W	D	ON/OFF	x	○

## ○ MALÌ COLOUR SELECTION

- **SB** | Silver Bombalai
- **BL** | Bronze Lario
- **RR** | Rust Rame
- **BF** | Beige Futuna
- **WI** | White Irazu
- **GK** | Gold Karkar
- **BT** | Blue Telica
- **BLL** | Black Lava

162  
163

## MALÌ S-AM BEAM ANGLE | DIMENSIONS



MALÌ S

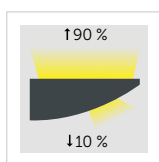

MALÌ AM

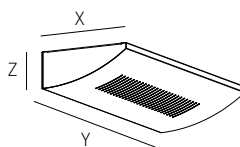

Size	X [mm]	Y [mm]	Z [mm]	Kg
<b>01</b>	235	360	92	3,5
<b>02</b>	235	600	92	6,8





Leila

# Ceila



Wall Mounted



## **IT**

Apparecchio decorativo per installazione a parete. Corpo in pressofusione di alluminio. Sorgente luminosa LED COB. Verniciatura con polveri epossidiche antigraffio. Schermo di chiusura in metacrilato trasparente.

## **ES**

Luminaria decorativa para instalación en pared. Cuerpo de aluminio fundido a presión. Fuente de iluminación LED COB. Recubierta con polvo epoxi anti-rayado. Difusor de metacrilato transparente.

## **EN**

Decorative lighting fitting for wall installation. Die-cast aluminium body. COB LED lighting source. Anti-scratch epoxy powder paint finish. Transparent methacrylate closing reflector.

## **DE**

Dekoratives Wandbeleuchtungsgerät. Körper aus Aluminiumdruckguss. COB LED-Leuchtmittel. Lackierung mit kratzfesten Epoxypulvern. Abdeckschirm aus transparent Methacrylat.

## **FR**

Appareils décoratif pour l'installation sur le mur. Corps en aluminium moulé sous pression. Source de lumière en LED COB. Finition de peinture en poudre époxy anti-rayures. Écran de fermeture en méthacrylate transparent.

## **RU**

Декоративный настенный светильник. Корпус из литого под давлением алюминия. Источник света СИД COB. Покрытие устойчивым к царапинам эпоксидным порошком. Закрывающий экран выполнен из прозрачного метакрилата.





## LEILA

Code	Size	Lumen	Watt	K	Beam angle	Driver Type	Driver no.	Colour
YLE25W	01	2600	26	W	D	ON/OFF	1	○

### ○ LEILA COLOUR SELECTION

○ BI | Bianco

● NE | Nero

### LEILA BEAM ANGLE | DIMENSIONS

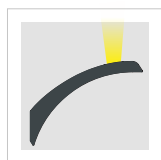

Size	X (mm)	Y (mm)	Z (mm)	Kg
01	252	195	145	1,1

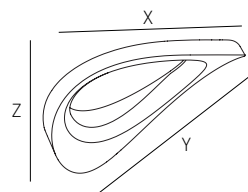





Norton

# Manten



## Wall Mounted



### IT

Apparecchio decorativo per installazione a parete con inclinazione regolabile. Corpo in pressofusione di alluminio. Sorgente luminosa LED. Verniciatura con polveri epossidiche antigraffio. Schermo di chiusura in metacrilato trasparente.

### ES

Luminaria decorativa para instalación en pared con inclinación regulable. Cuerpo de aluminio fundido a presión. Fuente de iluminación LED. Recubierta con polvo epoxi anti-rayado. Difusor de metacrilato transparente.

### EN

Decorative lighting fitting for wall installation with adjustable inclination. Die-cast aluminium body. LED lighting source. Anti-scratch epoxy powder paint finish. Transparent methacrylate closing reflector.

### DE

Dekoratives Wandbeleuchtungsgerät mit einstellbarer Neigung. Körper aus Aluminiumdruckguss. LED-Leuchtmittel. Lackierung mit kratzfesten Epoxypulvern. Abdeckschirm aus transparent Methacrylat.

### FR

Appareils décoratif pour l'installation sur le mur avec inclinaison réglable. Corps en aluminium moulé sous pression. Source de lumière en LED. Finition de peinture en poudre époxy anti-rayures. Écran de fermeture en méthacrylate transparent.

### RU

Декоративный настенный светильник с регулируемым наклоном. Корпус из литого под давлением алюминия. Источник света СИД. Покрытие устойчивым к царапинам эпоксидным порошком. Закрывающий экран выполнен из прозрачного метакрилата.

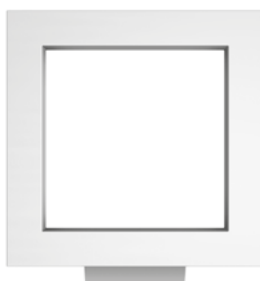

## NORTON

Code	Size	Lumen	Watt	K	Beam angle	Driver Type	Driver no.	Colour
YNO29W	01	1600	14	W	D	ON/OFF	1	○

### ○ NORTON COLOUR SELECTION

○ BI | Bianco

● NE | Nero

● RR | Grigio satinato

### NORTON BEAM ANGLE | DIMENSIONS



Size	X (mm)	Y (mm)	Z (mm)	Kg
01	290	40	290	1,6

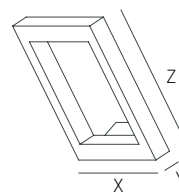

170  
171





Pia

# Pia



Wall Mounted



## IT

Apparecchio decorativo per installazione a parete. Corpo in pressofusione di alluminio. Sorgente luminosa LED COB. Verniciatura con polveri epossidiche antigraffio. Schermo di chiusura in metacrilato trasparente.

## EN

Decorative lighting fitting for wall installation. Die-cast aluminium body. COB LED lighting source. Anti-scratch epoxy powder paint finish. Transparent methacrylate closing reflector.

## FR

Appareils décoratif pour l'installation sur le mur. Corps en aluminium moulé sous pression. Source de lumière en LED COB. Finition de peinture en poudre époxy anti-rayures. Écran de fermeture en méthacrylate transparent.

## ES

Luminaria decorativa para instalación en pared. Cuerpo de aluminio fundido a presión. Fuente de iluminación LED COB. Recubierta con polvo epoxi anti-rayado. Difusor de metacrilato transparente.

## DE

Dekoratives Wandbeleuchtungsgerät. Körper aus Aluminiumdruckguss. COB LED-Leuchtmittel. Lackierung mit kratzfesten Epoxypulvern. Abdeckschirm aus transparent Methacrylat.

## RU

Декоративный настенный светильник. Корпус из литого под давлением алюминия. Источник света СИД COB. Покрытие устойчивым к царапинам эпоксидным порошком. Закрывающий экран выполнен из прозрачного метакрилата.

Lookup



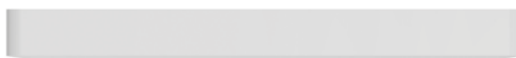

## PIA

Code	Size	Lumen	Watt	K	Beam angle	Driver Type	Driver no.	Colour
YPI20W	01	2000	26	W	D	ON/OFF	1	○

### ○ PIA COLOUR SELECTION

○ BI | Bianco

● NE | Nero

### PIA BEAM ANGLE | DIMENSIONS



Size	X (mm)	Y (mm)	Z (mm)	Kg
01	204	101	22	1,0

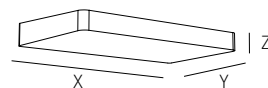





# Trem

# Tnem

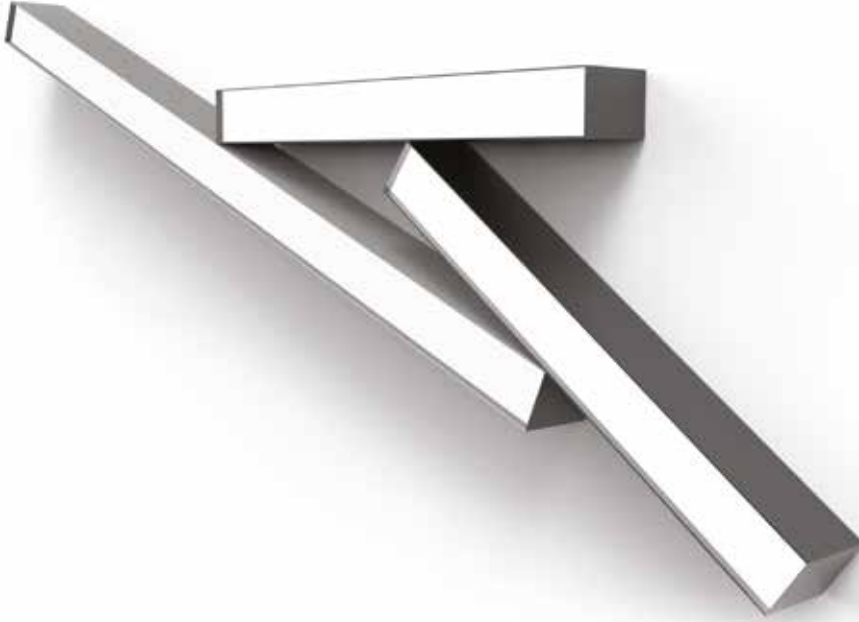

Wall Mounted

Ceiling Mounted



On request

## IT

Apparecchio decorativo per installazione a parete o plafone. Corpo in acciaio al carbonio pressopiegato. Sorgente luminosa LED multichip. Verniciatura con polveri epossidiche antigraffio. Schermo di chiusura in policarbonato opale.

## EN

Decorative lighting fitting for wall or ceiling installation. Bent carbon steel body. Multichip LED lighting source. Anti-scratch epoxy powder paint finish. Opal polycarbonate closing reflector.

## FR

Appareils décoratif pour l'installation sur le mur ou plafond. Corps en acier au carbone courbé. Source de lumière en LED multichip. Finition de peinture en poudre époxy anti-rayures. Écran de fermeture en polycarbonate opale.

## ES

Luminaria decorativa para instalación en pared y techo. Cuerpo de acero al carbono plegado. Fuente de iluminación LED multichip. Recubierta con polvo epoxi anti-rayado. Difusor de policarbonato opal.

## DE

Dekoratives Wand- und Deckenbeleuchtungsgerät. Körper aus pressgeformtem Kohlenstoffstahl. Multichip LED-Leuchtmittel. Lackierung mit kratzfesten Epoxypulvern. Abdeckschirm aus opalem Polycarbonat.

## RU

Декоративный настенный либо потолочный светильник. Корпус из прессованной углеродистой стали. Источник света мульткристальный СИД. Покрытие устойчивым к царапинам эпоксидным порошком. Закрывающий экран выполнен из матового поликарбоната.

Lookup

# TREM



## TREM VARIO *KELVIN*

Code	Size	Lumen	Watt	K	Beam angle	Driver Type	Driver no.	Colour
YTR15VK	01	6150	67	Vario	D	ON/OFF	2	○

## TREM

Code	Size	Lumen	Watt	K	Beam angle	Driver Type	Driver no.	Colour
YTR15W	01	6150	67	W	D	ON/OFF	2	○

## ○ TREM COLOUR SELECTION

- **SB** | Silver Bombalai
- **BL** | Bronze Lario
- **RR** | Rust Rame
- **BF** | Beige Futuna
- **WI** | White Irazu
- **GK** | Gold Karkar
- **BT** | Blue Telica
- **BLL** | Black Lava

178  
179

## TREM BEAM ANGLE | DIMENSIONS

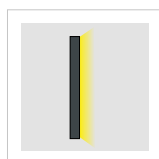

Size	X (mm)	Y (mm)	Z (mm)	Kg
<b>01</b>	1500	90	500	9,0

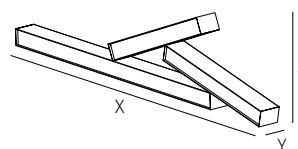





# Bomboei M

180  
181

# Bembei M



Only Wall Mounted



## IT

Apparecchio decorativo per installazione a parete composto da:

- Base portacablaggio con sorgente luminosa LED multichip e schermo di chiusura in policarbonato opalino.
- Frontale in alluminio tornito intercambiabile con fissaggio magnetico. Verniciatura con polveri epossidiche antigraffio.

## ES

Luminaria decorativa para instalación en pared compuesta de:

- Base soporte de cableado con fuente de iluminación LED multichip y difusor de policarbonato opal.
- Panel frontal de carbono plegado a presión intercambiable con sistema de fijación magnético. Recubierta con polvo epoxi anti-rayado.

## EN

Decorative lighting fitting for wall installation consisting of:

- Gear plate with multichip led lighting source and opal polycarbonate closing reflector.
- Interchangeable turned aluminum front with magnetic fixing. Anti-scratch epoxy powder paint finish.

## DE

Dekoratives Wandbeleuchtungsgerät zusammengesetzt aus:

- Verdrahtungsbasis mit multichip LED-Leuchtmittel und Abdeckschirm aus opalem Polycarbonat.
- Auswechselbare Vordere aus pressgeformtem Kohlenstoffstahl mit magnetischer Befestigung. Lackierung mit kratzfesten Epoxypulvern.

## FR

Appareils décoratif pour l'installation sur le mur consistant en:

- Socle de câblage avec source lumineuse LED et écran de fermeture en polycarbonate opale.
- Avant en aluminium tourné interchangeable avec fixation magnétique. Finition de peinture en poudre époxy anti-rayures.

## RU

Декоративный настенный светильник состоящий из:

- Основание с кабельной проводкой с источником света мульткристалльный СИД и закрывающий экран выполнен из матового поликарбоната.
- Лицевая сторона из формованного алюминия с магнитным креплением. Покрытие устойчивым к царапинам оксидным порошком.



# BOMBEI M



## BOMBEI M BASE

Code	Size	Lumen	Watt	K	Beam angle	Driver Type	Driver no.	Colour
YBOM39W	01	1750	21	W	D	ON/OFF	1	○

## BOMBEI M MAGNETIC COVER

Code	Size	●	●	●	●	●	●	●	●
YBOFM385	01	SB	BL	RR	BF	WI	GK	BT	BLL

## ○ BOMBEI M COLOUR SELECTION

- SB | Silver Bombalai
- BL | Bronze Lario
- RR | Rust Rame
- BF | Beige Futuna
- WI | White Irazu
- GK | Gold Karkar
- BT | Blue Telica
- BLL | Black Lava

182  
183

## BOMBEI M BEAM ANGLE | DIMENSIONS



Size	X (mm)	Y (mm)	Z (mm)	Kg
01	∅ 385	∅ 305	53	1,9

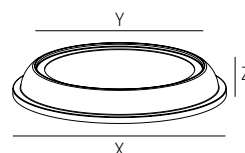





Pia

# Pla



Only Wall Mounted



## **IT**

Apparecchio decorativo per installazione a parete. Corpo in acciaio al carbonio pressopiegato. Sorgente luminosa LED multichip. Verniciatura con polveri epossidiche antigraffio. Schermo di chiusura in policarbonato opalino.

## **EN**

Decorative lighting fitting for wall. Bent carbon steel body. Multichip LED lighting source. Anti-scratch epoxy powder paint finish. Opal polycarbonate closing reflector.

## **FR**

Appareils décoratif pour l'installation sur le mur. Corps en acier au carbone courbé. Source de lumière en LED multichip. Finition de peinture en poudre époxy anti-rayures. Écran de fermeture en polycarbonate opale.

## **ES**

Luminaria decorativa para instalación en pared. Cuerpo de acero al carbono plegado a presión. Fuente de iluminación LED multichip. Recubierta con polvo epoxi anti-rayado. Difusor de policarbonato opal.

## **DE**

Dekoratives Wandbeleuchtungsgerät. Körper aus pressgeformtem Kohlenstoffstahl. Multichip LED-Leuchtmittel. Lackierung mit kratzfesten Epoxypulvern. Abdeckschirm aus opalem Polycarbonat.

## **RU**

Декоративный настенный светильник. Корпус из прессованной углеродистой стали. Источник света мульткристальный СИД. Покрытие устойчивым к царапинам эпоксидным порошком. Закрывающий экран выполнен из матового поликарбоната.

*Lookup*

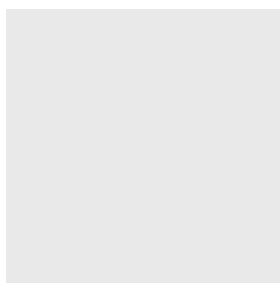

## PLA

Code	Size	Lumen	Watt	K	Beam angle	Driver Type	Driver no.	Colour
YPL30W	01	7300	64	W	D	ON/OFF	1	○

○ **PLA** COLOUR SELECTION

○ **BI** | Bianco

● **NE** | Nero

**PLA** BEAM ANGLE | DIMENSIONS

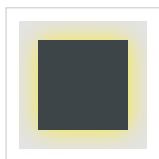

Size	X (mm)	Y (mm)	Z (mm)	Kg
<b>01</b>	300	54	300	2,7

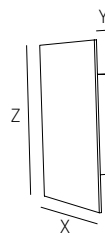



# Floor



*Lookup*





# Armaadellus

190  
191

# Amadeus



2700K | 3350K | 4000K



Floor



## IT

Lampada da terra decorativa. Corpo in acciaio al carbonio pressopiegato. Sorgente luminosa LED multichip. Verniciatura con polveri epossidiche antigraffio. Schermo di chiusura in policarbonato opale

## EN

Floor decorative lighting. Bent carbon steel body. Multichip LED lighting source. Anti-scratch epoxy powder paint finish. Opal polycarbonate closing reflector.

## FR

Décoratif lampe au sol. Corps en acier au carbone courbé. Source de lumière en LED multichip. Finition de peinture en poudre époxy anti-rayures. Écran de fermeture en polycarbonate opale.

## ES

Luminaria de suelo decorativa. Cuerpo de acero al carbono plegado. Fuente de iluminación LED multichip. Recubierta con polvo epoxi anti-rayado. Difusor de policarbonato opal.

## DE

Dekoratives Stehleuchte. Körper aus pressgeformtem Kohlenstoffstahl Multichip LED-Leuchtmittel. Lackierung mit kratzfesten Epoxypulvern. Abdeckschirm aus opalem Polycarbonat.

## RU

Декоративная напольная лампа. Корпус из прессованной углеродистой стали. Источник света мульткристальный СИД. Покрытие устойчивым к царапинам эпоксидным порошком. Закрывающий экран выполнен из матового поликарбоната

Lookup

# AMADEUS



## AMADEUS VARIO *KELVIN*

Code	Size	Lumen	Watt	K	Beam angle	Driver Type	Driver no.	Colour
YAM84VK	01	6720	84	Vario	D	ON/OFF	1	○

## AMADEUS

Code	Size	Lumen	Watt	K	Beam angle	Driver Type	Driver no.	Colour
YAM84W	01	6720	84	W	D	ON/OFF	1	○

## ○ AMADEUS COLOUR SELECTION

- **SB** | Silver Bombalai
- **BL** | Bronze Lario
- **RR** | Rust Rame
- **BF** | Beige Futuna
- **WI** | White Irazu
- **GK** | Gold Karkar
- **BT** | Blue Telica
- **BLL** | Black Lava

192  
193

## AMADEUS BEAM ANGLE | DIMENSIONS

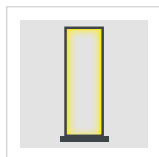

Size	X [mm]	Y [mm]	Z [mm]	K [mm]	Kg
<b>01</b>	∅ 320	340	1670	27	15,0





*Lookup*



# Silence

# Silence



Floor



## IT

Lampada da terra decorativa. Corpo in acciaio al carbonio pressopiegato. Sorgente luminosa LED multichip. Verniciatura con polveri epossidiche antigraffio. Schermo di chiusura in policarbonato opale.

## EN

Floor decorative lighting. Bent carbon steel body. Multichip LED lighting source. Anti-scratch epoxy powder paint finish. Opal polycarbonate closing reflector.

## FR

Décoratif lampe au sol. Corps en acier au carbone courbé. Source de lumière en LED multichip. Finition de peinture en poudre époxy anti-rayures. Écran de fermeture en polycarbonate opale.

## ES

Luminaria de suelo decorativa. Cuerpo de acero al carbono plegado. Fuente de iluminación LED multichip. Recubierta con polvo epoxi anti-rayado. Difusor de policarbonato opalo.

## DE

Dekoratives Stehleuchte. Körper aus pressgeformtem Kohlenstoffstahl Multichip LED-Leuchtmittel. Lackierung mit kratzfesten Epoxypulvern. Abdeckschirm aus opalem Polycarbonat.

## RU

Декоративная напольная лампа. Корпус из прессованной углеродистой стали. Источник света мультикристальный СИД. Покрытие устойчивым к царапинам эпоксидным порошком. Закрывающий экран выполнен из матового поликарбоната.

# SILENCE



## SILENCE VARIO *KELVIN*

Code	Size	Lumen	Watt	K	Beam angle	Driver Type	Driver no.	Colour
YSI34VK	01	2730	34	Vario	D	ON/OFF	1	○

## SILENCE

Code	Size	Lumen	Watt	K	Beam angle	Driver Type	Driver no.	Colour
YSI34W	01	2730	34	W	D	ON/OFF	1	○

## ○ SILENCE COLOUR SELECTION

- **SB** | Silver Bombalai
- **BL** | Bronze Lario
- **RR** | Rust Rame
- **BF** | Beige Futuna
- **WI** | White Irazu
- **GK** | Gold Karkar
- **BT** | Blue Telica
- **BLL** | Black Lava

196  
197

## SILENCE BEAM ANGLE | DIMENSIONS



Size	X (mm)	Y (mm)	Z (mm)	K (mm)	J (mm)	Kg
<b>01</b>	340	254	1632	27	300	10,0

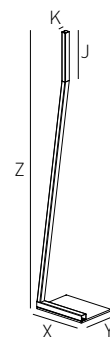







# Utile

# Utile



Floor



On request

## IT

Lampada da terra decorativa. Corpo in alluminio estruso. Struttura di supporto in acciaio al carbonio. Sorgente luminosa LED multichip. Verniciatura con polveri epossidiche antigraffio. Schermo di chiusura in policarbonato opale.

## ES

Luminaria de suelo decorativa. Cuerpo en aluminium extruido. Estructura de soporte en acero al carbono. Fuente de iluminación LED multichip. Recubierta con polvo epoxi anti-rayado. Difusor de policarbonato opal.

## EN

Floor decorative lighting. Extruded aluminium body. Support structure in carbon steel. Multichip LED lighting source. Anti-scratch epoxy powder paint finish. Opal polycarbonate closing reflector.

## DE

Dekoratives Stehleuchte. Körper aus extrudiertem Aluminium. Tragstruktur aus Kohlenstoffstahl. Multichip LED-Leuchtmittel. Lackierung mit kratzfesten Epoxypulvern. Abdeckschirm aus opalem Polycarbonat.

## FR

Décoratif lampe au sol. Corps en aluminium extrudé. Structure de support en acier au carbone. Source de lumière en LED multichip. Finition de peinture en poudre époxy anti-rayures. Écran de fermeture en polycarbonate opale.

## RU

Декоративная напольная лампа. Корпус из экструдированного алюминия. Опорный элемент выполнен из углеродистой стали. Источник света мультикристальный СИД. Покрытие устойчивым к царапинам эпоксидным порошком. Закрывающий экран выполнен из матового поликарбоната.

LookUp

# UTILE



## UTILE VARIO *KELVIN*

Code	Size	Lumen	Watt	K	Beam angle	Driver Type	Driver no.	Colour
------	------	-------	------	---	------------	-------------	------------	--------

### EMISSIONE INDIRETTA (I)

YUTI48VK	01	4390	48	Vario	D	ON/OFF	1	○
----------	----	------	----	-------	---	--------	---	---

Code	Size	Lumen	Watt	K	Beam angle	Driver Type	Driver no.	Colour
------	------	-------	------	---	------------	-------------	------------	--------

### EMISSIONE DIRETTA + INDIRETTA (D+I)

YUTDI72VK	01	6580	72	Vario	D	ON/OFF	1	○
-----------	----	------	----	-------	---	--------	---	---

## UTILE

Code	Size	Lumen	Watt	K	Beam angle	Driver Type	Driver no.	Colour
------	------	-------	------	---	------------	-------------	------------	--------

### EMISSIONE INDIRETTA (I)

YUTI48W	01	4390	48	W	D	ON/OFF	1	○
---------	----	------	----	---	---	--------	---	---

Code	Size	Lumen	Watt	K	Beam angle	Driver Type	Driver no.	Colour
------	------	-------	------	---	------------	-------------	------------	--------

### EMISSIONE DIRETTA + INDIRETTA (D+I)

YUTDI72W	01	6580	72	W	D	ON/OFF	1	○
----------	----	------	----	---	---	--------	---	---

200  
201

## ○ UTILE COLOUR SELECTION

- SB | Silver Bombalai
- BL | Bronze Lario
- RR | Rust Rame
- BF | Beige Futuna
- WI | White Irazu
- GK | Gold Karkar
- BT | Blue Telica
- BLL | Black Lava

## UTILE BEAM ANGLE | DIMENSIONS



I



D+I

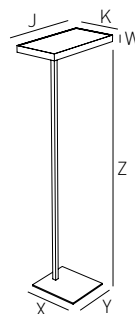

Size	X (mm)	Y (mm)	Z (mm)	J (mm)	K (mm)	W (mm)	Kg
01	400	355	1910	620	260	45	16,0





Zero

# Zene

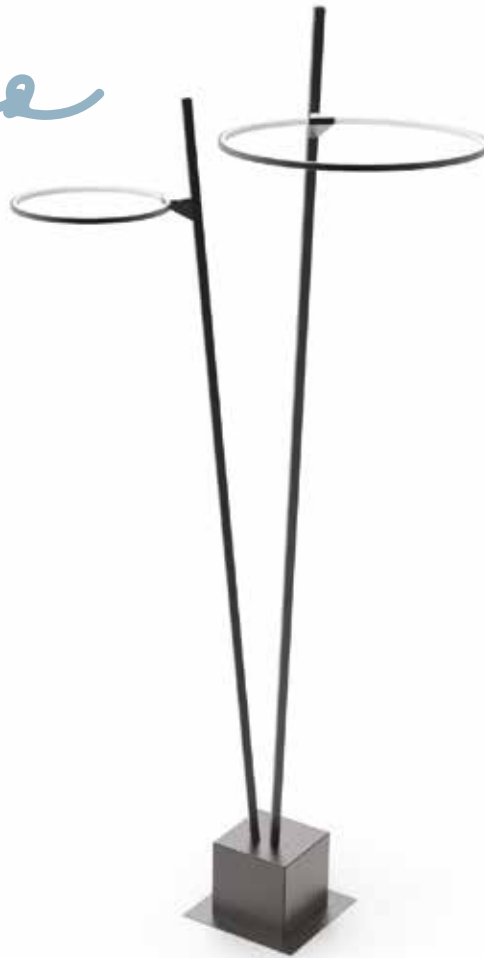

Floor



On request

## IT

Lampada da terra decorativa.  
Corpo in alluminio estruso calandrato  
Struttura di supporto in acciaio al carbonio.  
Sorgente luminosa LED multichip.  
Verniciatura con polveri epossidiche antigraffio. Schermo di chiusura in silicone opale.

## ES

Luminaria de suelo decorativa.  
Cuerpo de aluminio torneado y calandrado. Estructura de soporte en acero al carbono. Fuente de iluminación LED multichip. Recubierta con polvo epoxi anti-rayado. Difusor de silicona opal.

## EN

Floor for decorative lighting.  
Extruded and calendered aluminum body. Support structure in carbon steel. Multichip LED lighting source. Anti-scratch epoxy powder paint finish. Opal silicone closing reflector.

## DE

Dekoratives Stehleuchte.  
Extrudierter aus kalandrierter Aluminiumkörper.  
Tragstruktur aus Kohlenstoffstahl.  
Multichip LED-Leuchtmittel.  
Lackierung mit kratzfesten Epoxypulvern.  
Opalabdeckschirm aus Silikon.

## FR

Décoratif lampe au sol.  
Corps en aluminium extrudé et calandré.  
Structure de support en acier au carbone. Source de lumière en LED multichip. Finition de peinture en poudre époxy anti-rayures. Écran de fermeture en silicone opale.

## RU

Декоративная напольная лампа.  
Корпус из экструдированного каландрированного алюминия. Опорный элемент выполнен из углеродистой стали.  
Источник света мульткристальный СИД.  
Покрытие устойчивым к царапинам эпоксидным порошком.  
Закрывающий экран выполнен из матового силикона.

LookUp

# ZERO

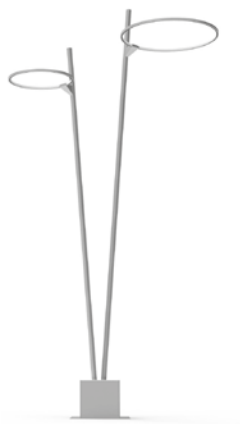

## ZERO VARIO *KELVIN*

Code	Size	Lumen	Watt	K	Beam angle	Driver Type	Driver no.	Colour
YZE66VK	01	6000	66	Vario	D	ON/OFF	1	○

## ZERO

Code	Size	Lumen	Watt	K	Beam angle	Driver Type	Driver no.	Colour
YZE66W	01	6000	66	W	D	ON/OFF	1	○

## ○ ZERO COLOUR SELECTION

- **SB** | Silver Bombalai
- **BL** | Bronze Lario
- **RR** | Rust Rame
- **BF** | Beige Futuna
- **WI** | White Irazu
- **GK** | Gold Karkar
- **BT** | Blue Telica
- **BLL** | Black Lava

204  
205

## ZERO BEAM ANGLE | DIMENSIONS



Size	X [mm]	Y [mm]	J [mm]	Z [mm]	K [mm]	W [mm]	Kg
01	300	300	200	2100	1900	*	15,0

\* W [mm]:



1= ø 325

2= ø 485

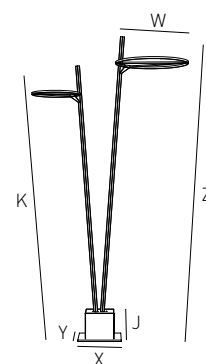







206  
207

Birboa

# Binba



Floor



On request

## IT

Lampada da terra decorativa.  
Corpo diffusore in alluminio estruso verniciato con polveri epossidiche antigraffio. Sorgente luminosa LED COB. Schermo di chiusura in metacrilato trasparente.

## EN

Floor for decorative lighting.  
Diffuser body painted with anti-scratch epoxy powders. COB LED lighting source. Transparent methacrylate closing reflector.

## FR

Décoratif lampe au sol.  
Corp diffuseur en aluminium extrudé avec finition de peinture en poudre époxy anti-rayures. Source de lumière en LED COB. Écran de fermeture en méthacrylate transparent.

## ES

Luminaria de suelo decorativa.  
Cuerpo difusor de aluminio extruido recubierto con polvo epoxi anti-rayado. Fuente de iluminación LED COB. Difusor de metacrilato transparente.

## DE

Dekoratives Stehleuchte.  
Diffusorkörper aus extrudiertem Aluminium. Lackierung mit kratzfesten Epoxypulvern. COB LED-Leuchtmittel. Abdeckschirm aus transparentem Methacrylat.

## RU

Декоративная напольная лампа.  
Корпус-диффузор из экструдированного алюминия, покрытого устойчивым к царапинам оксидным порошком. Источник света СИД COB. Закрывающий экран выполнен из прозрачного метакрилата.

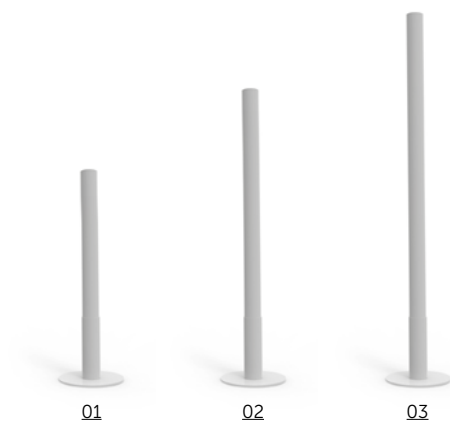

## BIRBA VARIO *KELVIN*

Code	Size	Lumen	Watt	K	Beam angle	Driver Type	Driver no.	Colour
YBI13VK	01	1830	20	Vario	D	ON/OFF	1	○
YBI18VK	02	1830	20	Vario	D	ON/OFF	1	○
YBI23VK	03	1830	20	Vario	D	ON/OFF	1	○

## BIRBA

Code	Size	Lumen	Watt	K	Beam angle	Driver Type	Driver no.	Colour
YBI13W	01	1830	20	W	D	ON/OFF	1	○
YBI18W	02	1830	20	W	D	ON/OFF	1	○
YBI23W	03	1830	20	W	D	ON/OFF	1	○

## ○ BIRBA COLOUR SELECTION

- **SB** | Silver Bombalai
- **BL** | Bronze Lario
- **RR** | Rust Rame
- **BF** | Beige Futuna
- **WI** | White Irazu
- **GK** | Gold Karkar
- **BT** | Blue Telica
- **BLL** | Black Lava

## BIRBA BEAM ANGLE | DIMENSIONS

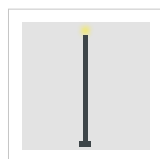

Size	X (mm)	Y (mm)	Z (mm)	Kg
<b>01</b>	Ø 320	Ø 90	1360	14,0
<b>02</b>	Ø 320	Ø 90	1860	15,0
<b>03</b>	Ø 320	Ø 90	2360	16,0





*Lookup*



210  
211

Furboa

# Furba



Floor



On request

## IT

Lampada da terra decorativa. Vano alimentatore in alluminio estruso verniciato con polveri epossidiche antigraffio. Sorgente luminosa LED multichip. Corpo diffusore in policarbonato opale.

## EN

Floor decorative lighting. Extruded aluminium power supply compartment. Anti-scratch epoxy powder paint finish. Multichip LED lighting source. Opal polycarbonate diffuser body.

## FR

Décoratif lampe au sol. Compartiment d'alimentation en aluminium extrudé. Finition de peinture en poudre époxy anti-rayures. Source de lumière en LED multichip. Corps diffuseur en polycarbonate opale.

## ES

Luminaria de suelo decorativa. compartimento de fuente de alimentación en aluminio extruido. Fuente de iluminación LED multichip. Recubierta con polvo epoxi anti-rayado. Cuerpo difusor de policarbonato opal.

## DE

Dekoratives Stehleuchte. Netzteilfach aus extrudiertem Aluminium. Lackierung mit kratzfesten Epoxypulvern. Multichip LED-Leuchtmittel. Diffusor Körper aus opalem Polycarbonat.

## RU

Декоративная напольная лампа. Отсек для блока питания из экструдированного алюминия, покрытого устойчивым к царапинам эпоксидным порошком. Источник света мульткристальный СИД. Корпус-диффузор из матового поликарбоната

# FURBA

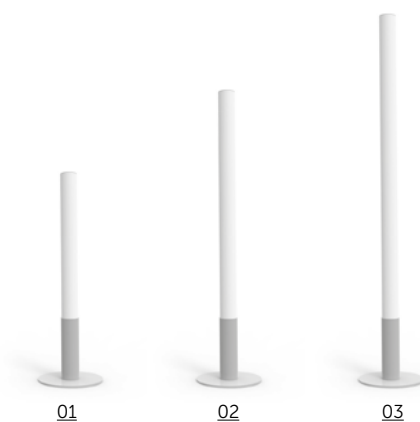

## FURBA

Code	Size	Lumen	Watt	K	Beam angle	Driver Type	Driver no.	Colour
YFU13W	01	4200	53	W	D	ON/OFF	1	○
YFU18W	02	6300	79	W	D	ON/OFF	1	○
YFU23W	03	8400	106	W	D	ON/OFF	1	○

## ○ FURBA COLOUR SELECTION

- **SB** | Silver Bombalai
- **BL** | Bronze Lario
- **RR** | Rust Rame
- **BF** | Beige Futuna
- **WI** | White Irazu
- **GK** | Gold Karkar
- **BT** | Blue Telica
- **BLL** | Black Lava

## FURBA BEAM ANGLE | DIMENSIONS

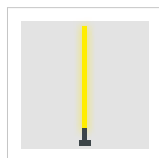

Size	X [mm]	Y [mm]	Z [mm]	K [mm]	J [mm]	Kg
<b>01</b>	Ø 320	Ø 83	1360	1000	350	14,2
<b>02</b>	Ø 320	Ø 83	1860	1500	350	15,5
<b>03</b>	Ø 320	Ø 83	2360	2000	350	17,2

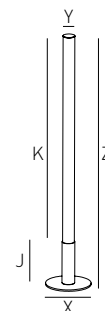

212  
213



*Lookup*





# Recessed





# Downlights

216  
217

# Demi



Recessed



On request

## IT

Apparecchio decorativo per installazione ad incasso. Corpo in acciaio al carbonio pressopiegato. Sorgente luminosa LED COB. Verniciatura con polveri epossidiche antigraffio. Schermo di chiusura in metacrilato trasparente.

## ES

Luminaria decorativa para instalación empotrables. Cuerpo en acero al carbono plegado a presión. Fuente de iluminación LED COB. Recubierta con polvo epoxi anti-rayado. Difusor de metacrilato transparente.

## EN

Decorative lighting fitting for recessed installation. Bent carbon steel body. COB LED lighting source. Anti-scratch epoxy powder paint finish. Transparent methacrylate closing reflector.

## DE

Dekoratives Einbauleuchtungsgerät. Körper aus pressgeformtem Kohlenstoffstahl. COB LED-Leuchtmittel. Lackierung mit kratzfesten Epoxypulvern. Abdeckschirm aus transparent Methacrylat.

## FR

Appareils décoratif pour installation encastrée. Corps en aluminium moulé sous pression (ORIENT Q), corps en acier au carbone courbé (DEMI). Source de lumière en LED COB. Finition de peinture en poudre époxy anti-rayures. Écran de fermeture en méthacrylate transparent.

## RU

Декоративный встраиваемый светильник. Корпус из прессованной углеродистой стали. Источник света СИД COB. Покрытие устойчивым к царапинам эпоксидным порошком. Закрывающий экран выполнен из прозрачного метакрилата.

Lookup

# DEMI LED

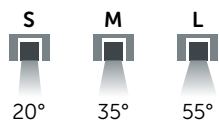

## DEMI LED VARIO *LUMEN*

Code	Size	Lumen	Watt	K	Beam angle	Driver Type	Driver no.	Colour
YDE84VLSW	01	1220   1470   1710	10   11   13	W	S	ON/OFF	1	○
YDE84VLMW	01	1220   1470   1710	10   11   13	W	M	ON/OFF	1	○
YDE84VLLW	01	1220   1470   1710	10   11   13	W	L	ON/OFF	1	○

## ○ DEMI LED COLOUR SELECTION

- **SB** | Silver Bombalai
- **BL** | Bronze Lario
- **RR** | Rust Rame
- **BF** | Beige Futuna
- **WI** | White Irazu
- **GK** | Gold Karkar
- **BT** | Blue Telica
- **BLL** | Black Lava

## DEMI LED BEAM ANGLE | DIMENSIONS



Size	X (mm)	Y (mm)	Z (mm)	 (mm)	Kg
<b>01</b>	84	84	max 113	70x70	0,2

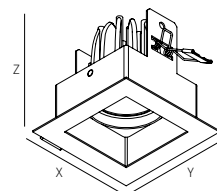

218  
219

# Sei



## Recessed



On request

### **IT**

Apparecchio decorativo per installazione ad incasso. Corpo in pressofusione di alluminio. Sorgente luminosa LED COB. Verniciatura con polveri epossidiche antigraffio. Schermo di chiusura in metacrilato trasparente.

### **EN**

Decorative lighting fitting for recessed installation. Die-cast aluminium body. COB LED lighting source. Anti-scratch epoxy powder paint finish. Opal methacrylate closing reflector.

### **FR**

Appareils décoratif pour installation encastrée. Corps en aluminium moulé sous pression. Source de lumière en LED COB. Finition de peinture en poudre époxy anti-rayures. Écran de fermeture en méthacrylate opal.

### **ES**

Luminaria decorativa para instalación empotrables. Cuerpo de aluminio fundido a presión Fuente de iluminación LED COB. Recubierta con polvo epoxi anti-rayado. Difusor de metacrilato opal.

### **DE**

Dekoratives Einbauleuchtungsgerät. Körper aus Aluminiumdruckguss. COB LED-Leuchtmittel. Lackierung mit kratzfesten Epoxypulvern. Abdeckschirm aus Opalmethacrylat.

### **RU**

Декоративный встраиваемый светильник. Корпус из литого под давлением алюминия. Источник света СИД COB. Покрытие устойчивым к царапинам эпоксидным порошком. Закрывающий экран выполнен из прозрачного метакрилата.

Lookup

SEI



**SEI** VARIO

Code	Size	Lumen	Watt	K	Beam angle	Driver Type	Driver no.	Colour
YSE10W	01	1300	13	W	D	ON/OFF	1	○

**SEI** COLOUR SELECTION

**BI** | Bianco

**SEI** BEAM ANGLE | DIMENSIONS

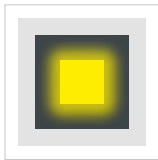

Size	X (mm)	Y (mm)	Z (mm)	$\theta$ (mm)	Kg
01	100	100	80	92x92	0,5

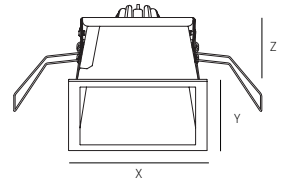

220  
221

# Clue



Recessed



On request

## IT

Apparecchio decorativo per installazione ad incasso. Corpo in alluminio tornito. Sorgente luminosa LED COB. Verniciatura con polveri epossidiche antigraffio. Schermo di chiusura in metacrilato trasparente.

## EN

Decorative lighting fitting for recessed installation. Turned aluminum body. COB LED lighting source. Anti-scratch epoxy powder paint finish. Transparent methacrylate closing reflector.

## FR

Appareils décoratif pour installation encastrée. Corps en aluminium tourné sous pression. Source de lumière en LED COB. Finition de peinture en poudre époxy anti-rayures. Écran de fermeture en méthacrylate transparent.

## ES

Luminaria decorativa para instalación empotrables. Cuerpo de aluminio torneado. Fuente de iluminación LED COB. Recubierta con polvo epoxi anti-rayado. Difusor de metacrilato transparente.

## DE

Dekoratives Einbauleuchtungsgerät. Körper aus gedrehtem Aluminium. COB LED-Leuchtmittel. Lackierung mit kratzfesten Epoxypulvern. Abdeckschirm aus transparent Methacrylat.

## RU

Декоративный встраиваемый светильник. Корпус из литого под давлением алюминия. Источник света СИД COB. Покрытие устойчивым к царапинам эпоксидным порошком. Закрывающий экран выполнен из прозрачного метакрилата.

Lookup



# UNO

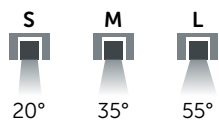

## UNO VARIO LUMEN

Code	Size	Lumen	Watt	K	Beam angle	Driver Type	Driver no.	Colour
YUN92VLSW	01	1220   1470   1710	10   11   13	W	S	ON/OFF	1	○
YUN92VLMW	01	1220   1470   1710	10   11   13	W	M	ON/OFF	1	○
YUN92VLLW	01	1220   1470   1710	10   11   13	W	L	ON/OFF	1	○

## ○ UNO COLOUR SELECTION

- SB | Silver Bombalai
- BL | Bronze Lario
- RR | Rust Rame
- BF | Beige Futuna
- WI | White Irazu
- GK | Gold Karkar
- BT | Blue Telica
- BLL | Black Lava

## UNO BEAM ANGLE | DIMENSIONS



Size	X (mm)	Z (mm)	$\theta$ (mm)	Kg
01	Ø 92	110	Ø 87	0,2

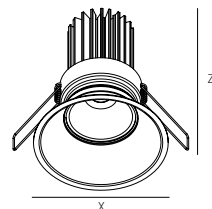

222  
223

# Rie



Recessed  
Ceiling Mounted



SELV



**5Y WARRANTY**  
5% FAILURE RATE

**60.000 h**  
LED LIFETIME **L90B10**

**DL**  
DALI

**EM**  
EN 60598-2-22

On request

## IT

Apparecchio decorativo per installazione ad incasso (01) o plafone (02). Corpo in pressofusione di alluminio. Sorgente luminosa LED COB. Verniciatura con polveri epossidiche antigraffio. Schermo di chiusura in metacrilato trasparente.

## ES

Luminaria decorativa para instalación empotrables (01) o techo (02). Cuerpo de aluminio fundido a presión Fuente de iluminación LED COB. Recubierta con polvo epoxi anti-rayado. Difusor de metacrilato transparente.

## EN

Decorative lighting fitting for recessed (01) or ceiling (02) installation. Die-cast aluminium body. COB LED lighting source. Anti-scratch epoxy powder paint finish. Transparent methacrylate closing reflector.

## DE

Dekoratives Einbauleuchtungsgerät (01) oder Deckenbeleuchtungsgerät (02). Körper aus Aluminiumdruckguss. COB LED-Leuchtmittel. Lackierung mit kratzfesten Epoxypulvern. Abdeckschirm aus transparentem Methacrylat.

## FR

Appareils décoratif pour installation encastrée (01) ou au plafond (02). Corps en aluminium moulé sous pression. Source de lumière en LED COB. Finition de peinture en poudre époxy anti-rayures. Écran de fermeture en méthacrylate transparent.

## RU

Декоративный встраиваемый (01) или потолочный (02) светильник. Корпус из литого под давлением алюминия. Источник света СИД COB. Покрытие устойчивым к царапинам эпоксидным порошком. Закрывающий экран выполнен из прозрачного метакрилата

Lookup

# RIO



R



CM

## RIO R

Code	Size	Lumen	Watt	K	Beam angle	Driver Type	Driver no.	Colour
YRIR10W	R	1180	13	W	D	ON/OFF	1	○

## RIO CM

Code	Size	Lumen	Watt	K	Beam angle	Driver Type	Driver no.	Colour
YRICM10W	CM	1180	13	W	D	ON/OFF	1	○

### ○ RIO COLOUR SELECTION

○ BI | Bianco

● NE | Nero

224  
225

### RIO BEAM ANGLE | DIMENSIONS

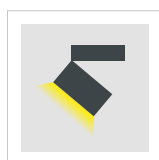

Size	X (mm)	Y (mm)	Z (mm)	∅ (mm)	Kg
R	∅ 100	50	56	∅ 89	1,25

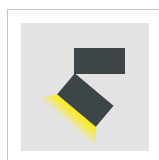
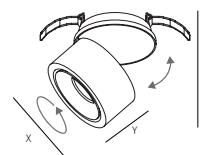

Size	X (mm)	Y (mm)	Z (mm)	Kg
CM	∅ 100	50	100	1,50

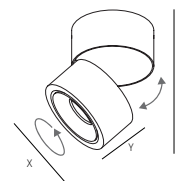

# Mene



Recessed



On request

## IT

Apparecchio decorativo per installazione ad incasso. Corpo e riflettore alluminio tornito. Sorgente luminosa LED multichip. Verniciatura con polveri epossidiche antigraffio. Schermo di chiusura in policarbonato opale.

## EN

Decorative lighting fitting for recessed installation. Turned aluminum body and reflector. Multichip LED lighting source. Anti-scratch epoxy powder paint finish. Opal polycarbonate closing reflector.

## FR

Appareils décoratif pour installation encastrée. Corps et réflecteur en aluminium tourné sous pression. Source de lumière en LED COB. Finition de peinture en poudre époxy anti-rayures. Écran de fermeture en méthacrylate transparent.

## ES

Luminaria decorativa para instalación empotrables. Cuerpo y reflector de aluminio torneado. Fuente de iluminación LED COB. Recubierta con polvo epoxi anti-rayado. Difusor de metacrilato transparente.

## DE

Dekoratives Einbauleuchtungsgerät. Körper und Reflektor aus gedrehtem Aluminium. COB LED-Leuchtmittel. Lackierung mit kratzfesten Epoxypulvern. Abdeckschirm aus transparent Methacrylat.

## RU

Декоративный встраиваемый светильник. Корпус и рефлектор из формованного алюминия. Источник света мульткристальный СИД. Покрытие устойчивым к царапинам эпоксидным порошком. Закрывающий экран выполнен из матового поликарбоната.

Lookup

# NERO



## NERO VARIO **LUMEN** | VARIO **KELVIN**

Code	Size	Vario Lumen	Watt	K	Beam angle	Driver Type	Driver no.	Colour
YNE15VKL	01	920   1370   1830	10   15   20	Vario	D	ON/OFF	1	○
YNE20VKL	02	920   1370   1830	10   15   20	Vario	D	ON/OFF	1	○
YNE23VKL	03	920   1370   1830	10   15   20	Vario	D	ON/OFF	1	○

## ○ **NERO** COLOUR SELECTION

● BLL | Black Lava

## NERO BEAM ANGLE | DIMENSIONS

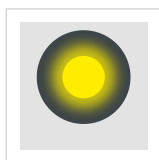

Size	X (mm)	Z (mm)	$\theta$ (mm)	Kg
<b>01</b>	Ø 150	56	Ø 135	1,25
<b>02</b>	Ø 200	56	Ø 180	1,50
<b>03</b>	Ø 230	56	Ø 210	1,75

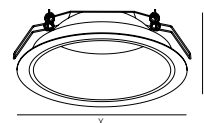

226  
227





# HOLLOW

228  
229

# Hallow



2700K | 3350K | 4000K



## Recessed



On request

### IT

Apparecchio decorativo per installazione ad incasso. Telaio in pressofusione di alluminio. Corpo in acciaio al carbonio pressopiegato. Sorgente luminosa LED multichip. Verniciatura con polveri epossidiche antigraffio. Schermo di chiusura interno in policarbonato microprismato. Schermo frontale in policarbonato opale.

### ES

Luminaria decorativa para instalación empotrables. Estructura en aluminio fundido a presión. Cuerpo en acero al carbono calandrado. Fuente de iluminación LED multichip. Recubierta con polvo epoxi anti-rayado. Difusor interno de policarbonato microprismático. Difusor frontal de policarbonato opal.

### EN

Decorative lighting fitting for recessed installation. Die-cast aluminum frame. Bent carbon steel body. Multichip LED lighting source. Anti-scratch epoxy powder paint finish. Microprismatic polycarbonate internal closing reflector. Opal polycarbonate front closing reflector.

### DE

Dekoratives Einbauleuchtungsgerät. Gestell aus Aluminium-Druckguss. Körper aus kalandriertem Kohlenstoffstahl. Multichip LED-Leuchtmittel. Lackierung mit kratzfesten Epoxypulvern. Außer Abdeckschirm aus Mikroprismen-Polycarbonat. Frontabdeckschirm aus Opalpolycarbonat.

### FR

Appareils décoratif pour installation encastrée. Cadre en aluminium moulé sous pression. Corps en acier au carbone calandré. Source de lumière en LED multichip. Finition de peinture en poudre époxy anti-rayures. Écran de fermeture interne en polycarbonate microprismatique. Écran avant en polycarbonate opal.

### RU

Декоративный встраиваемый светильник. Рама из литого под давлением алюминия. Корпус из прессованной углеродистой стали. Источник света мультикристальный СИД. Покрытие устойчивым к царапинам эпоксидным порошком.



# HOLLOW



01



02



03

## HOLLOW VARIO *LUMEN* | VARIO *KELVIN*

Code	Size	Vario Lumen	Watt	K	Beam angle	Driver Type	Driver no.	Colour
YHO20VKL	01	1050   1570   2090	10   15   20	Vario	D	ON/OFF	1	○
YHO33VKL	02	2090   3140   4180	20   30   40	Vario	D	ON/OFF	1	○
YHO46VKL	03	3140   4700   6270	30   45   59	Vario	D	ON/OFF	1	○

## ○ HOLLOW COLOUR SELECTION

- **SB** | Silver Bombalai
- **BL** | Bronze Lario
- **RR** | Rust Rame
- **BF** | Beige Futuna
- **WI** | White Irazu
- **GK** | Gold Karkar
- **BT** | Blue Telica
- **BLL** | Black Lava

## HOLLOW BEAM ANGLE | DIMENSIONS

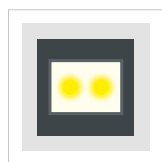

Size	X (mm)	Y (mm)	Z (mm)	(mm)	Kg
<b>01</b>	200	200	181	182x182	1,0
<b>02</b>	200	333	181	182x320	2,0
<b>03</b>	200	467	181	182x455	3,0

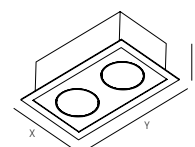



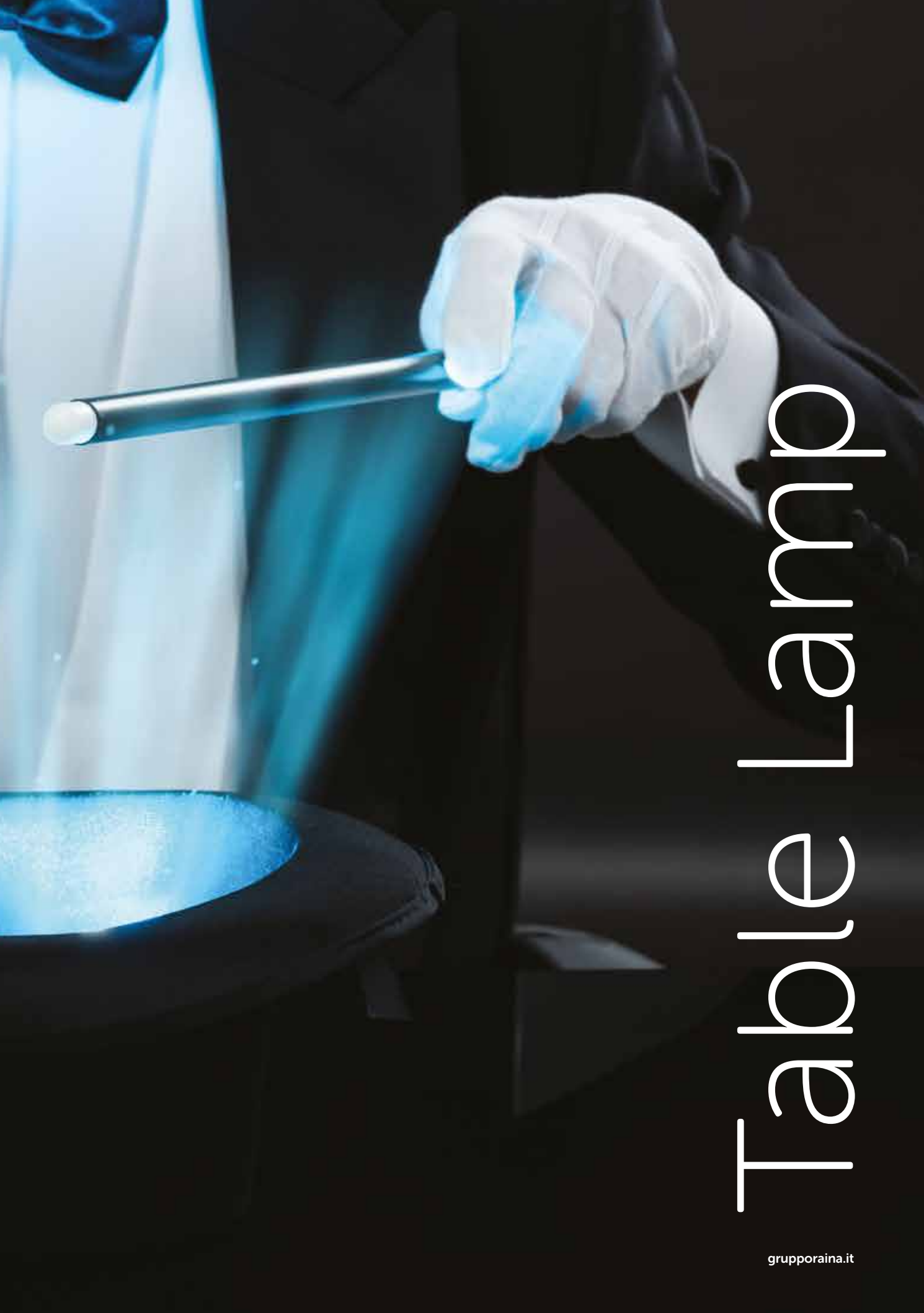

# Table Lamp





234  
235

Lina

# Cina



2700K | 3350K | 4000K



Table Lamp



On request

## IT

Lampada da tavolo decorativa. Base d'appoggio in acciaio al carbonio pressopiegato. Corpo lampada in alluminio estruso calandratato. Sorgente luminosa LED multichip. Verniciatura con polveri epossidiche antigraffio. Schermo di chiusura in silicone opale.

## ES

Luminaria de mesa decorativa. Base de apoyo en acero al carbono plegado a presión. Cuerpo en aluminio extruido y calandrado. Fuente de iluminación LED multichip. Recubierta con polvo epoxi anti-rayado. Difusor de silicona opal.

## EN

Decorative table lamp. Bent carbon steel base support. Calendered extruded aluminum body. Multichip LED lighting source. Anti-scratch epoxy powder paint finish. Opal silicon closing reflector.

## DE

Dekorative Tischlampe. Stützbasis aus pressgeformtem Kohlenstoffstahl. Lampenkörper aus kalandriertem und extrudiertem Aluminium. Multichip LED-Leuchtmittel. Lackierung mit kratzfesten Epoxypulvern. Abdeckschirm aus opal Silikon.

## FR

Lampe de table decorative. Base de support en acier au carbone courbé. Corps de lampe en aluminium extrudé et calandré. Source de lumière en LED multichip. Finition de peinture en poudre époxy anti-rayures. Écran de fermeture en silicone opale.

## RU

Декоративная настольная лампа. Основание из прессованной углеродистой стали. Корпус лампы из экструдированного каландрированного алюминия. Источник света мультикристальный СИД. Покрытие устойчивым к царапинам эпоксидным порошком. Закрывающий экран выполнен из матового силикона.

Lookup

# LINA



## LINA VARIO **LUMEN** | VARIO **KELVIN**

Code	Size	Vario Lumen	Watt	K	Beam angle	Driver Type	Driver Nr.	Colour
YL116VKL	01	350   520   690	5   8   11	Vario	D	ON/OFF	1	○

## ○ LINA COLOUR SELECTION

- **SB** | Silver Bombalai
- **BL** | Bronze Lario
- **RR** | Rust Rame
- **BF** | Beige Futuna
- **WI** | White Irazu
- **GK** | Gold Karkar
- **BT** | Blue Telica
- **BLL** | Black Lava

## LINA BEAM ANGLE | DIMENSIONS

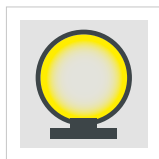

Size	X [mm]	Y [mm]	Z [Ø]	Kg
<b>01</b>	130	130	Ø 165	1,2

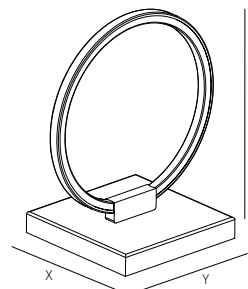

236  
237







# Squadra

238  
239

# Squadra

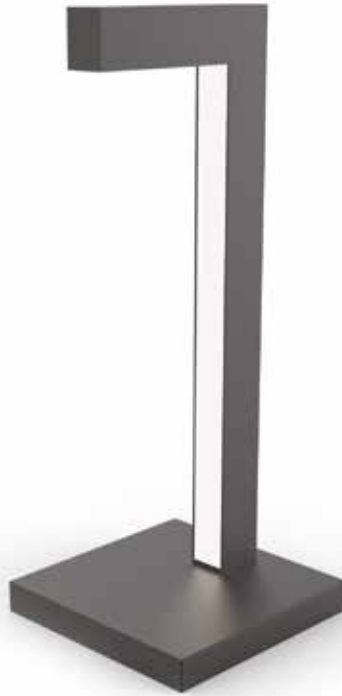

Table Lamp



On request

## IT

Lampada da tavolo decorativa  
Base d'appoggio e corpo lampada in acciaio al carbonio pressopiegato. Sorgente luminosa LED multichip. Verniciatura con polveri epossidiche antigraffio. Schermo di chiusura in policarbonato opale.

## ES

Luminaria de mesa decorativa.  
Base de apoyo y cuerpo en acero al carbono plegado a presión. Fuente de iluminación LED multichip. Recubierta con polvo epoxi anti-rayado. Difusor de policarbonato opal.

## EN

Decorative table lamp. Bent carbon steel base support and body. Multichip LED lighting source. Anti-scratch epoxy powder paint finish. Opal polycarbonate closing reflector.

## DE

Dekorative Tischlampe. Stützbasis und Lampenkörper aus pressgeformtem Kohlenstoffstahl. Multichip LED-Leuchtmittel. Lackierung mit kratzfesten Epoxypulvern. Abdeckschirm aus opal Polycarbonat.

## FR

Lampe de table decorative. Base de support et corps en acier au carbone courbé. Source de lumière en LED multichip. Finition de peinture en poudre époxy anti-rayures. Écran de fermeture en polycarbonate opale.

## RU

Декоративная настольная лампа  
Основание и корпус лампы из прессованной углеродистой стали.  
Источник света мультикристальный СИД.  
Покрывание устойчивым к царапинам эпоксидным порошком.  
Закрывающий экран выполнен из матового поликарбоната.

Lookup

# SQUADRA



## SQUADRA VARIO **LUMEN** | VARIO **KELVIN**

Code	Size	Lumen	Watt	K	Beam angle	Driver Type	Driver Nr.	Colour
YSQ43VKL	01	530   790   1050	7   10   13	Vario	D	ON/OFF	1	○

## ○ SQUADRA COLOUR SELECTION

- **SB** | Silver Bombalai
- **BL** | Bronze Lario
- **RR** | Rust Rame
- **BF** | Beige Futuna
- **WI** | White Irazu
- **GK** | Gold Karkar
- **BT** | Blue Telica
- **BLL** | Black Lava

## SQUADRA BEAM ANGLE | DIMENSIONS

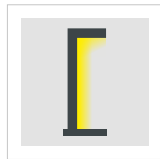

Size	X (mm)	Y (mm)	Z (mm)	Kg
<b>01</b>	150	150	430	1,6

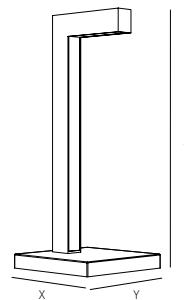

240  
241





242  
243

Sphere

# Sphere



Table Lamp



On request

## IT

Lampada da tavolo decorativa. Base d'appoggio in acciaio al carbonio pressopiegato. Corpo diffusore in policarbonato opale. Sorgente luminosa LED multichip. Verniciatura con polveri epossidiche antigraffio.

## EN

Decorative table lamp. Bent carbon steel base support. Opal polycarbonate body diffusor. Multichip LED lighting source. Anti-scratch epoxy powder paint finish.

## FR

Lampe de table decorative. Base de support en acier au carbone courbé. Corps diffuseur en polycarbonate opale. Source de lumière en LED multichip. Finition de peinture en poudre époxy anti-rayures.

## ES

Luminaria de mesa decorativa. Base de apoyo y cuerpo en acero al carbono pegado a presión. Cuerpo difusor de policarbonato opal. Fuente de iluminación LED multichip. Recubierta con polvo epoxi anti-rayado.

## DE

Dekorative Tischlampe. Stützbasis und Lampenkörper aus pressgeformtem Kohlenstoffstahl. Diffusor Körper aus opalem Polycarbonat. Multichip LED-Leuchtmittel. Lackierung mit kratzfesten Epoxypulvern.

## RU

Декоративная настольная лампа. Основание из прессованной углеродистой стали. Корпус-диффузор из матового поликарбоната. Источник света мультикристальный СИД. Покрытие устойчивым к царапинам эпоксидным порошком.

# SPHERE

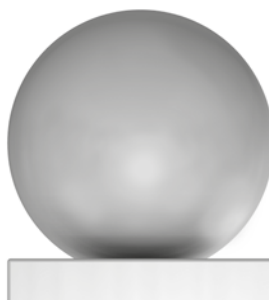

## SPHERE VARIO *LUMEN* | VARIO *KELVIN*

Code	Size	Lumen	Watt	K	Beam angle	Driver Type	Driver Nr.	Colour
YSP15VKL	01	610   920   1220	7   10   13	Vario	D	ON/OFF	1	○

## ○ SPHERE COLOUR SELECTION

- **SB** | Silver Bombalai
- **BL** | Bronze Lario
- **RR** | Rust Rame
- **BF** | Beige Futuna
- **WI** | White Irazu
- **GK** | Gold Karkar
- **BT** | Blue Telica
- **BLL** | Black Lava

## SPHERE BEAM ANGLE | DIMENSIONS

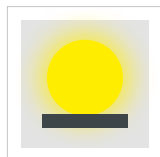

Size	X [mm]	Y [mm]	Z [mm]	∅	Kg
<b>01</b>	150	150	25	∅ 150	1,2

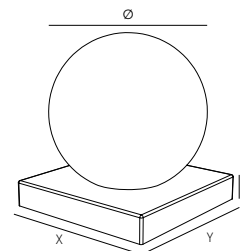

244  
245







246  
247

Stilo

# Stile



Table Lamp



On request

## IT

Lampada da tavolo decorativa  
Base d'appoggio e corpo lampada in acciaio al carbonio pressopiegato. Sorgente luminosa LED multichip. Verniciatura con polveri epossidiche antigraffio. Schermo di chiusura in policarbonato opale.

## ES

Luminaria de mesa decorativa. Base de apoyo y cuerpo en acero al carbono plegado a presión. Fuente de iluminación LED multichip. Recubierta con polvo epoxi anti-rayado. Difusor de policarbonato opal.

## EN

Decorative table lamp. Bent carbon steel base support and body Multichip LED lighting source. Anti-scratch epoxy powder paint finish. Opal polycarbonate closing reflector.

## DE

Dekorative Tischlampe. Stützbasis und Lampenkörper aus pressgeformtem Kohlenstoffstahl. Multichip LED-Leuchtmittel. Lackierung mit kratzfesten Epoxypulvern. Abdeckschirm aus opal Polycarbonat.

## FR

Lampe de table decorative. Base de support et corps en acier au carbone courbé. Source de lumière en LED multichip. Finition de peinture en poudre époxy anti-rayures. Écran de fermeture en polycarbonate opale.

## RU

Декоративная настольная лампа  
Основание и корпус лампы из прессованной углеродистой стали.  
Источник света мультикристальный СИД.  
Покрытие устойчивым к царапинам эпоксидным порошком.  
Закрывающий экран выполнен из матового поликарбоната.

Lookup

# STILO



## STILO VARIO **LUMEN** | VARIO **KELVIN**

Code	Size	Lumen	Watt	K	Beam angle	Driver Type	Driver Nr.	Colour
YST32VKL	01	320   480   630	4   6   8	Vario	D	ON/OFF	1	○

## ○ STILO COLOUR SELECTION

- **SB** | Silver Bombalai
- **BL** | Bronze Lario
- **RR** | Rust Rame
- **BF** | Beige Futuna
- **WI** | White Irazu
- **GK** | Gold Karkar
- **BT** | Blue Telica
- **BLL** | Black Lava

## STILO BEAM ANGLE | DIMENSIONS



Size	X [mm]	Y [mm]	Z [mm]	Kg
<b>01</b>	150	150	320	1,2

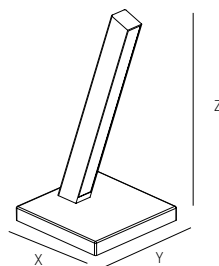

248  
249

# INDEX

## ANALITICAL PRODUCTS INDEX

Code	Page	Code	Page	Code	Page
YAD13VK	91	YBOFM385	183	YES60VK	147
YAD13W	91	YBOM39W	183	YES60W	147
YAD18VK	91	YCA21VKL	131	YES90VK	147
YAD18W	91	YCA21W	131	YES90W	147
YAD23VK	91	YCA41VKL	131	YFAFM145	127
YAD23W	91	YCA41W	131	YFAM14VKL	127
YAL16W	119	YCA61VKL	131	YFU13W	213
YAM84VK	193	YCA61W	131	YFU18W	213
YAM84W	193	YCI32W	95	YFU23W	213
YAQI11VK	31	YCI48W	95	YGI18W	159
YAQI11W	31	YCI64W	95	YGI41W	159
YAQI15VK	31	YDE84VLLW	219	YGI80W	159
YAQI15W	31	YDE84VLMW	219	YHO20VKL	231
YAQL11VK	33	YDE84VLSW	219	YHO33VKL	231
YAQL11W	33	YDO23VK	155	YHO46VKL	231
YAQL15VK	33	YDO23W	155	YJEL11W	49
YAQL15W	33	YDO40VK	155	YJEL15W	49
YAR10VK	75	YDO40W	155	YJEL11W	51
YAR10W	75	YDO60VK	155	YJEL15W	51
YAR12VK	75	YDO60W	155	YLE25W	167
YAR12W	75	YDU23VK	151	YLI11VK	103
YAR15VK	75	YDU23W	151	YLI11W	103
YAR15W	75	YDU40VK	151	YLI15VK	103
YAR20VK	75	YDU40W	151	YLI15W	103
YAR20W	75	YDU60VK	151	YLI16VKL	237
YAR30VK	75	YDU60W	151	YLO16W	59
YAR30W	75	YELI11VK	37	YLO20VKL	59
YBI13VK	209	YELI11W	37	YLO23W	59
YBI13W	209	YELI15VK	37	YLO30W	59
YBI18VK	209	YELI15W	37	YLO39W	59
YBI18W	209	YELL11VK	39	YMA16W	63
YBI23VK	209	YELL11W	39	YMA20VKL	63
YBI23W	209	YELL15VK	39	YMA23W	63
YBLN16W	113	YELL15W	39	YMA30W	63
YBLN20VKL	113	YES30VK	147	YMA39W	63
YBLN23W	113	YES30W	147	YMAM36W	163
YBLN30W	113	YES40VK	147	YMAM60W	163
YBLN39W	113	YES40W	147	YMAS36W	163

# INDEX

## ANALITICAL PRODUCTS INDEX

Code	Page
YMAS60W	163
YNE15VKL	227
YNE20VKL	227
YNE23VKL	227
YNO29W	171
YNRI11VK	43
YNRI11W	43
YNRI15VK	43
YNRI15W	43
YNRL11VK	45
YNRL11W	45
YNRL15VK	45
YNRL15W	45
YOL58W	99
YOPI11VK	107
YOPI11W	107
YOPI15VK	107
YOPI15W	107
YOPL11VK	109
YOPL11W	109
YOPL15VK	109
YOPL15W	109
YPI20W	175
YPL30W	187
YRICM10W	225
YRIR10W	225
YRO120VKL	71
YRO120W	71
YRO27W	67
YRO36W	67
YRO55VKL	67
YRO55W	67
YRO60VKL	71
YRO60W	71
YRO75VKL	67
YRO75W	67
YRO90VKL	71
YRO90W	71

Code	Page
YSE10W	221
YSI34VK	197
YSI34W	197
YSP15VKL	245
YSQ43VKL	241
YSQD60W	55
YSQD80W	55
YSQDI60W	55
YSQDI80W	55
YST32VKL	249
YTA14W	143
YTA17W	143
YTA32W	143
YTAFM145	141
YTAFM175	141
YTAFM325	141
YTAM14VKL	141
YTAM17VKL	141
YTAM32VKL	141
YTI22VKL	123
YTI22W	123
YTI30VKL	123
YTI30W	123
YTI50VKL	123
YTI50W	123
YTR15VK	179
YTR15W	179
YTUCM14LW	83
YTUCM14MW	83
YTUCM14SW	83
YTUCM40LW	83
YTUCM40MW	83
YTUCM40SW	83
YTUCM60LW	83
YTUCM60MW	83
YTUCM60SW	83
YTUS14LW	85
YTUS14MW	85

Code	Page
YTUS14SW	85
YTUS40LW	85
YTUS40MW	85
YTUS40SW	85
YTUS60LW	85
YTUS60MW	85
YTUS60SW	85
YUF01W	79
YUN92VLLW	223
YUN92VLMW	223
YUN92VLSW	223
YUTDI72VK	201
YUTDI72W	201
YUTI48VK	201
YUTI48W	201
YZE66VK	205
YZE66W	205
YZO23W	137
YZO40W	137
YZO60W	137
YZOFM225	135
YZOFM395	135
YZOFM595	135
YZOM23VKL	135
YZOM40VKL	135
YZOM60VKL	135

## ANALITICAL ACCESSOIRES INDEX

YKT35	67
YKT10207	103
YKT10209D	103
YKT10209S	103
YKT45	67, 71
YKT65	75
YKTC65	75

# CONNECTION SCHEME

## ON/OFF

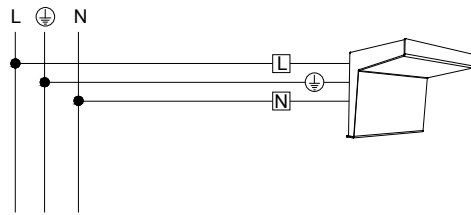

## PUSH DIM

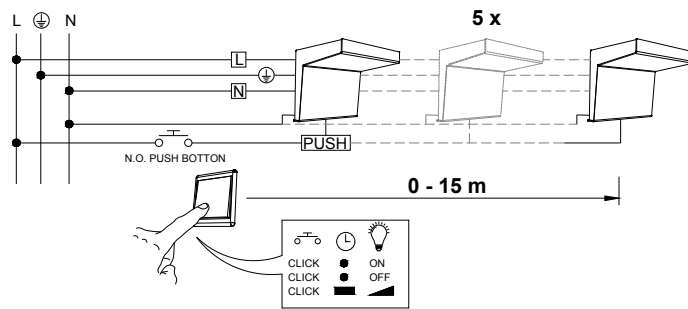

## DALI

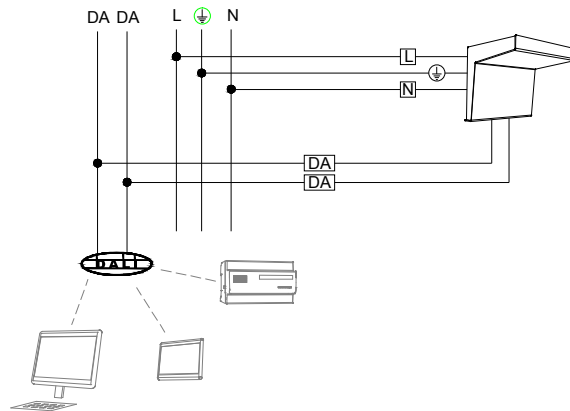

## EM

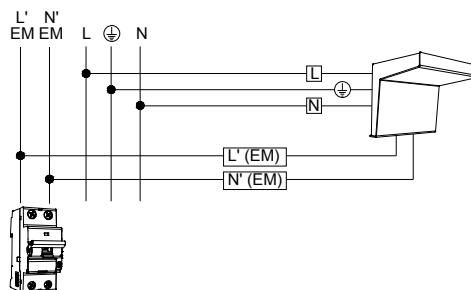

# CONDIZIONI GENERALI DI VENDITA

## 1. PREMESSE

Le forniture comprendono solo quanto espressamente specificato nella conferma di accettazione dell'ordine della ditta Venditrice e sono regolate dalle presenti condizioni generali, salvo deroghe risultanti da esplicito accordo scritto. Eventuali variazioni o comunicazioni durante il corso della fornitura non costituiscono invalidazione del contratto. I termini di consegna convenuti hanno valore indicativo e non tassativo. In qualunque momento l'esecuzione della fornitura potrà essere sospesa in caso di mutamento nelle condizioni patrimoniali del Committente ai sensi dell'Art. 1461 del Codice Civile.

## 2. PREZZI

I prezzi si intendono Franco Fabbrica della ditta Venditrice. Essi non comprendono prestazioni ed oneri non menzionati. Gli imballaggi sono inclusi nel prezzo, salvo diversa pattuizione scritta.

## 3. VARIABILITA' PREZZI

I prezzi indicati nel contratto sono stati calcolati in base ai costi dei materiali e della manodopera alla data del contratto stesso, in base alle relative tabelle dell'ANIE. Il sistema di calcolo delle variazioni di qualsiasi entità in più o in meno, che dovessero verificarsi sui detti costi durante il periodo dell'esecuzione della vendita, verrà effettuato in base alle clausole di variabilità prezzi vigenti per apparecchi di illuminazione pubblicato dall'ANIE.

## 4. MODALITA' DI PAGAMENTO

Si riconoscono solo i pagamenti fatti direttamente al nostro domicilio o a persone da noi autorizzate.

## 5. RISERVA DI PROPRIETA'

La ditta Venditrice conserva la proprietà sui materiali fino a totale pagamento di essi, ma i rischi sono assunti dal compratore sin dalla consegna. Qualunque atto del Committente che, salvo esplicito consenso scritto della Ditta venditrice, involga pregiudizio al diritto della Ditta Venditrice alla rivendita del materiale, sarà sottoposto alle sanzioni di legge.

## 6. CONSEGNA

Il termine di consegna indicato non impegna la Ditta Venditrice, la quale non è tenuta a corrispondere indennizzi di sorta per eventuali danni diretti ed indiretti dovuti a ritardi di consegna o ad interruzione od a risoluzione parziale o totale della fornitura. Il termine di consegna decorre dalla data della conferma d'ordine e in ogni caso non ha inizio prima del ricevimento della rata di pagamento all'ordine quando essa sia stata concordata. Esso si intende di diritto adeguatamente prorogato se i pagamenti non vengono effettuati puntualmente, se il Committente manca di fornire in tempo utile quanto stabilito nel contratto o se comunque insorgono cause indipendenti dalla Ditta Venditrice, ivi compresi eventuali ritardi di subfornitori.

## 7. RESO MERCE

La merce può essere resa esclusivamente previa autorizzazione della Ditta Venditrice e con un deprezzamento minimo del 30%

## 8. TRASPORTO

La merce viaggia rischio e pericolo del Committente comprese le eventuali rotture anche se spedita in porto franco. Trascorsi 8 giorni dal ricevimento non si accettano reclami. Gli ordini saranno evasi secondo la disponibilità e le spedizioni potranno essere fatte anche parzialmente.

## 9. DATI TECNICI

I materiali forniti, salvo diverse particolari prescrizioni da concordarsi per iscritto, corrispondono alle vigenti norme del CEI - Comitato Elettrotecnico Italiano, ove queste siano applicabili. La ditta Venditrice si riserva di apportare in qualunque momento ai propri prodotti quelle modifiche che ritenesse tecnicamente convenienti. I disegni dalle Ditta Venditrice sono di sua proprietà e non possono dal Committente essere consegnati a terzi né prodotti senza autorizzazione scritta.

## 10. GARANZIA

Ideallux garantisce i suoi prodotti per 24 mesi dalla data di fabbricazione indicata sul prodotto. La garanzia copre tutti i difetti di fabbricazione siano essi di natura meccanica o elettronica. Non sono inclusi in garanzia tutti i danni causati dalla movimentazione e/o utilizzo errato e non conforme a quanto riportato sulle istruzioni d'uso. La garanzia decade nel caso in cui i prodotti vengano manomessi e/o modificati.

Il prodotto difettoso per cui è richiesto l'intervento in garanzia, può essere riparato o sostituito con un articolo complementare sia nuovo che ricondizionato ad insindacabile giudizio di Ideallux. I prodotti che riportano il marchio "5 years warranty" sono coperti da 5 anni di garanzia considerando 14h/giorno per 365 giorni solari annuali, nel rispetto del lifetime indicato sulla scheda prodotto. I reclami per interventi in garanzia entro i 5 anni dalla data di fabbricazione (ad esclusione di quelli ricevuti entro i termini legislativi sopra indicati) saranno soggetti ad approvazione di Ideallux. Guasti che rientrano nella difettosità fisiologica dichiarata e comunque entro il 5% del totale degli articoli installati non sono coperti dalla garanzia 5 anni. Termini e condizioni generali di garanzia sono disponibili e possono essere richiesti presso la sede Ideallux.

## 11. CONTROVERSIE

I contratti, anche se stipulati con cittadini esteri o per materiali forniti all'estero, sono regolati dalla vigente legislatura italiana. Foro competente è soltanto quello avente giurisdizione nella sede legale della Ditta Venditrice anche in deroga agli art. 32 e seguenti del Codice di Procedura Civile, esclusa per il Committente la possibilità di adire l'Autorità Giudiziarie di altro luogo anche in via di garanzia o di connessione di causa, ma salva la facoltà alla Ditta Venditrice di esperire, in qualità di attrice, un'azione nel luogo di residenza, in Italia o all'estero, del Committente. Le eventuali contestazioni non dispensano il Committente dall'osservare le condizioni di pagamento pattuite e non implicano alcun prolungamento dei termini convenuti. Le spese di contratto, la sua registrazione e l'eventuale trascrizione sono a carico del Committente.

# GENERAL SALES CONDITIONS

## 1. INTRODUCTION

The supplies include only what is expressly specified in the order acceptance confirmation of the Vending Company and are governed by these general conditions, save for provisions resulting from an explicit written agreement. Any changes or notifications during the supply do not constitute the invalidation of the contract. The agreed delivery terms are merely indicative and are not binding. The execution of the supply may be suspended at any time due to changes to the financial conditions of the Buyer in accordance with the Art. 1461 of the Italian Civil Code.

## 2. PRICES

The prices are Ex-works of the Vending Company and do not include services at charges that have not been mentioned. The packages are included in price. The package cannot be returned, save for a different written agreement.

## 3. CHANGES IN PRICES

The prices shown in the contract were calculated based on the costs of the materials and of the labor on the date of the contract based on the related ANIE tables. The calculation system of any kind of changes, whether more or less, that may arise to said costs during the period of execution of the sale will be carried out based on the clauses of the changes of prices in force for lighting equipment published by ANIE.

## 4. PAYMENT

We recognize as valid payment only the ones made directly to our address or to our authorized people.

## 5. RETENTION OF TITLE

The Vending Company keeps the ownership of materials until paid in full, but the risks are assumed by the Buyer upon delivery. Any action of the Buyer, that results in prejudice to the right of the Vending Company to resell the material, will be subjected to legal sanctions, save for the explicit written consent of the Vending Company.

## 6. DELIVERY

The delivery period shown does not bind the Vending Company, which is not bound to pay indemnities arising for any direct or indirect damage due to delivery delays, downtime or the partial or total return of the supply. The delivery period is effective from the date of the order confirmation and in any case does not begin prior to having received the payment instalment for the agreed amount. This term is adequately extended by right if the payments are not made punctually, if the Buyer fails to supply what is set out in the contract in useful time or if causes nonetheless arise regardless of the Vending Company, therein including any delays of sub-contractors.

## 7. RETURN OF GOODS

The goods may only be returned upon the authorization of the Vending Company and with a depreciation of 30%.

## 8. TRANSPORT

The goods travel at Customer's risks and danger, even if in case of damage in fall of delivery terms Free destination.

## 9. TECHNICAL DATA

Save for special prescriptions to be agreed in writing, the materials supplied correspond to the standards in force of the CEI (Italian Electrical and Technical Council), where applicable. The Vending Company reserves the right to change its products at any time where deemed technically convenient. The designs of the Vending Company are its own property and may not be given by the Buyer to third parties without written authorization.

## 10. WARRANTY

IDEALLUX guarantees its products for 24 months from the date of production indicated on the item. The warranty covers all manufacturing defects whether they are of a mechanical or electronic nature. All damage caused by handling and / or incorrect use, or use not in accordance with the instructions indicated in the operating instructions are not covered by this warranty. The warranty will expire if the products are tampered with and / or modified. The defective product requiring warranty intervention can be repaired or replaced with a similar article both new and reconditioned at the discretion of Ideallux. The products with mark "5 years warranty" are covered by 5 years warranty considering 14 h / day for 365 solar annual days, respecting the lifetime indicated in the product data sheet. Claims for warranty work within 5 years from the date of manufacture (except those received within the above mentioned legislative terms) will be subject to Ideallux approval. Faults that fall within the declared physiological defect and in any case within 5% of the total installed items will not be covered by the 5 years warranty. Warranty general terms and conditions are available and can be requested at Ideallux offices.

## 11. DISPUTES

Even if stipulated with foreign citizens or for materials supplied abroad, the contracts are governed by the Italian legislation in force. The only competent court is the one having jurisdiction in the registered office of the Vending Company, also in provision of Art. 32 and ff. of the Italian Code of Civil Procedure, apart from the Buyer's possibility of applying to the Judicial Authority of another place also as a guarantee or related cause, but save for the right of the Vending Company to carry out an action in the place of residence of the Buyer in Italy or abroad as the plaintiff. Any disputes do not waive the Buyer from observing the agreed payment conditions and do not imply any extension of the agreed terms. The costs of the contract, its registration and transcription are at the expense of the Buyer.

# CONDITIONS GÉNÉRALES DE VENTE

## 1. GÉNÉRALITÉS

Les fournitures comprennent exclusivement les indications expressément spécifiées dans la confirmation d'acceptation de la commande par le vendeur et sont réglementées par les conditions générales présentes, sauf en cas de dérogations résultant d'accord écrit explicite. Des variations éventuelles ou des communications durant le déroulement de la fourniture ne constituent pas d'invalidation du contrat. Les termes de livraison convenus ont une valeur indicative et non impérative. À tout moment, l'exécution de la fourniture pourra être suspendue en cas de changement dans les conditions patrimoniales du Client aux termes de l'article 1461 du Code Civil.

## 2. PRIX

Les prix sont départ usine du vendeur, ils ne comprennent pas les charges pour prestations non mentionnées. Les emballages ne sont pas à retourner, sauf en cas de convention contraire écrite.

## 3. VARIATIONS DES PRIX

Les prix indiqués dans le contrat ont été calculés en fonction des coûts des matériaux et de la main d'œuvre à la date du contrat, en fonction des tableaux de l'ANIE correspondants. Le système de calcul des variations de toute entité en plus ou en moins qui aurait lieu sur ces coûts durant la période de l'exécution de la vente, sera effectué en fonction des clauses de variation des prix en vigueur pour les appareils d'éclairage publiées par l'ANIE.

## 4. MODALITÉS DE PAIEMENT

Les paiements pourront être effectués uniquement au domicile du vendeur ou à des personnes autorisées.

## 5. RÉSERVE DE PROPRIÉTÉ

Le Vendeur conserve la propriété sur les matériels jusqu'au paiement total de ceux-ci mais les risques sont assumés par l'acheteur dès la livraison. Tout acte du Client, sauf en cas de consentement écrit explicite du vendeur, qui porterait préjudice au droit du Vendeur en cas de revente du matériel sera soumis à des sanctions légales.

## 6. LIVRAISON

Le délai de livraison indiqué n'engage pas le Vendeur et ne pourra pas donner droit à des indemnités d'aucune sorte pour éventuels dommages directs et indirects dus à des retards de livraison ou à une interruption ou à une résolution partielle ou totale de la fourniture. Le délai de livraison prend effet à partir de la date de confirmation de commande et dans tous les cas ne commence pas avant la réception du paiement accordé par acompte de la commande. Sa prorogation est légalement valable : en cas de paiements qui ne seraient pas effectués ponctuellement, si le Client ne fournit pas en temps utile ce qui est établi sur le contrat ou si des causes indépendantes de la volonté du Vendeur surviennent, y compris des retards éventuels des sous-traitants.

## 7. RENDU DE MARCHANDISE

La marchandise peut être vendue exclusivement avec l'accord du vendeur et avec une dépréciation de 30 %.

## 8. TRANSPORT

La marchandise voyage aux risques et périls du Client y compris les éventuelles ruptures même si l'expédition est franco destination. Le Vendeur n'acceptera pas de réclamations au-delà du délai de 8 jours à partir de la date de réception. Les commandes seront expédiées selon les disponibilités et les expéditions pourront être effectuées même partiellement.

## 9. DONNÉES TECHNIQUES

Les matériaux fournis, sauf en cas de prescriptions particulières à accorder par écrit, correspondent aux normes en vigueur du CEI – Comité Electrotechnique Italien là où elles sont applicables. Le vendeur se réserve le droit d'apporter toute modification qu'il retient techniquement appropriée à tout moment aux propres produits. Les dessins des Vendeurs sont de sa propriété et le Client ne peut pas les livrer à des tiers, ni les produire sans autorisation écrite.

## 10. GARANTIE

Ideallux garantit tous ses produits pendant 24 mois à partir de la date de fabrication indiquée sur le produit. La garantie couvre tous les défauts de fabrication de nature mécanique ou électronique. Tous les dommages causés par la maintenance et/ou l'utilisation incorrecte et non conforme aux indications figurant sur les instructions d'utilisation sont exclus de la garantie. La garantie n'est pas valable en cas d'endommagement et/ou modification des produits. Le produit défectueux pour lequel on demande une intervention sous garantie, peut être réparé ou remplacé par un article complémentaire neuf ou reconditionné selon les critères de jugement, sans appel, de Ideallux. Les produits portant la mention "5 years warranty" sont couverts par une garantie de 5 ans considérant 14 heures/jour pour 365 jours, dans le respect de la Durée de vie (lifetime) indiquée sur la fiche technique du produit. Les réclamations pour des interventions garanties durant les 5 années à partir de la date de fabrication (à l'exclusion de celles reçues dans les délais législatifs indiqués ci-dessus) seront soumises à l'approbation de Ideallux. Les pannes faisant partie d'un défaut physiologique déclaré et à hauteur de 5 % du total des articles installés ne sont pas couverts par la garantie de 5 ans. Les termes et conditions générales de garantie sont disponibles et peuvent être demandés au siège de Ideallux.

## 11. CONTROVERSES

Les contrats, même stipulés avec des citoyens étrangers ou pour des matériaux fournis à l'étranger, sont réglementés par la législation italienne en vigueur. Le tribunal compétent est exclusivement celui de la juridiction du siège légal du Vendeur même en cas de dérogation aux art. 32 et art. suivants du Code de Procédure Civile, le client n'ayant pas la possibilité de recourir aux voies légales d'un autre lieu même à titre de garantie ou de connexité. Le Vendeur a la faculté d'avoir recours, en qualité d'acteur, à une action en justice sur le lieu de résidence du Client, en Italie ou à l'étranger. Les contestations éventuelles ne dispensent pas le client d'observer les conditions de paiement accordées et n'impliquent aucunement le prolongement des termes convenus. Les frais de contrat, son enregistrement et sa transcription éventuelle sont à la charge du Client.

# CONDICIONES GENERALES DE VENTA

## 1. PREMISAS

Los suministros incluyen solamente lo expresamente especificado al confirmar la aceptación del pedido de la Compañía Vendedora y son regulados por las presentes condiciones generales, salvo excepción resultante de un explícito acuerdo por escrito. Posibles variaciones o comunicaciones durante el transcurso del suministro no constituyen la invalidación del contrato. Los plazos de entrega convenidos tienen valor indicativo y no perentorio. En cualquier momento la ejecución del suministro podrá ser suspendida en caso de modificación de las condiciones patrimoniales del Cliente a efectos del Art. 1461 del Código Civil Italiano.

## 2. PRECIOS

Los precios se suponen Franco Fábrica de la Compañía Vendedora. Los mismos no incluyen prestaciones ni cargos no mencionados. Los embalajes se consideran incluidos en el precio, salvo acuerdo contrario por escrito.

## 3. VARIACIÓN DE PRECIOS

Los precios indicados en el contrato han sido calculados según los costes del material y de la mano de obra a la fecha del contrato mismo, según el índice correspondiente de la ANIE (Asociación industrial italiana del sector eléctrico y electrónico). El cálculo de las variaciones de cualquier índole, que pudieren verificarse sobre dichos costes durante el periodo de ejecución de la venta, se efectuará según las cláusulas de variación de los precios vigentes para luminarias publicado por la ANIE.

## 4. FORMA DE PAGO

Se reconocen solamente los pagos efectuados directamente a nuestro domicilio o a nuestro personal autorizado.

## 5. RESERVA DE DOMINIO

La Compañía Vendedora mantiene la propiedad sobre los materiales hasta el pago total de estos, pero los riesgos son asumidos por parte del comprador desde el momento de la entrega. Cualquier acto del Cliente que, salvo explícito consentimiento por escrito de la compañía vendedora, afecte el derecho del Vendedor a la reventa del material, estará sujeto a las sanciones establecidas por la ley.

## 6. ENTREGA

El plazo de entrega indicado no compromete a la empresa Vendedora, la cual no está obligada a pagar indemnizaciones de ningún tipo por eventuales daños directos o indirectos como consecuencia de retrasos en la entrega o interrupción o terminación parcial o total del suministro de productos. El plazo de entrega corre desde la fecha de confirmación del pedido y en todo caso no comienza hasta la recepción de la cuota de pago en el plazo acordado. Dicho plazo se considerará automáticamente prorrogado si los pagos no se efectúan puntualmente, si el Cliente no proporciona a tiempo lo establecido en el contrato o si de todos modos surgen causas independientes de la empresa Vendedora, incluidas demoras por parte de subcontratistas.

## 7. DEVOLUCIÓN

La mercadería se puede devolver exclusivamente previa autorización de la empresa Vendedora y con una depreciación mínima del 30%.

## 8. TRANSPORTE

La mercadería viaja a riesgo y responsabilidad del Cliente incluidas las posibles roturas incluso cuando fuese enviada con porte pagado. Transcurridos ocho días de la recepción no se aceptan reclamos. Los pedidos serán despachados según la disponibilidad y los envíos pueden realizarse parcialmente.

## 9. DATOS TÉCNICOS

Los materiales suministrados, a menos que se acuerde lo contrario por escrito, corresponden a las normas vigentes del CEI – Comité Electrotécnico Italiano, donde estas sean aplicables. La empresa Vendedora se reserva el derecho de aportar en cualquier momento a sus productos aquellas modificaciones que considere técnicamente convenientes. Los diseños de la empresa Vendedora son de su absoluta propiedad y no pueden ser entregados por el Cliente a terceros ni reproducidos sin previa autorización escrita.

## 10. GARANTÍA

Ideallux garantiza sus productos por 24 meses a partir de la fecha de fabricación indicada en el producto. La garantía cubre todo defecto de fabricación sea el mismo de índole mecánica o electrónica. No están incluidos en la garantía los daños causados por manipulación y/o uso incorrectos o no conforme a lo escrito en las instrucciones de uso. La garantía queda sin efecto en el caso en que los productos fuesen alterados y/o modificados. El producto defectuoso por el cual se solicita la intervención de la garantía, puede ser reparado o sustituido con un artículo complementario nuevo o reacondicionado a criterio indiscutible de Ideallux. Los productos que llevan la marca "5 years warranty" están cubiertos por 5 años de garantía considerando 14h/día por 365 días anuales, respetando la vida útil indicada en la ficha del producto. Los reclamos para aplicación de la garantía dentro de los 5 años de la fecha de fabricación (excepto aquellos recibidos antes de los términos legislativos ya indicados) serán sometidos a la aprobación de Ideallux. Aquellos desperfectos que se consideren dentro de la defectuosidad fisiológicamente declarada y en todo caso dentro del 5% del total de los artículos instalados no están cubiertos por la garantía de 5 años. Los plazos y las condiciones generales de garantía están disponibles y pueden ser requeridos a la sede de Ideallux.

## 11. CONTROVERSIAS

Los contratos, incluso cuando fueren celebrados con ciudadanos extranjeros o para materiales vendidos al exterior, son regulados por la legislación italiana vigente. El Foro competente será exclusivamente el que tenga jurisdicción en la sede legal de la empresa Vendedora no obstante lo dispuesto por el Art. 32 y siguientes del Código de Procedimiento Civil Italiano, excluida para el Cliente la posibilidad de recurrir a la Autoridad Judicial de otro lugar, incluso como garantía o en relación con la causa, pero sin perjuicio de la facultad de la empresa Vendedora de interponer una acción al Cliente, en calidad de demandante, en el lugar de residencia, en Italia o al exterior. Las eventuales disputas no eximirán al Cliente de respetar las condiciones de pago pactadas y no implican ninguna prolongación de los plazos convenidos. Los gastos de contrato, su registro y la eventual transcripción quedan a cargo del Cliente.



# ALLGEMEINE VERKAUFSBEDINGUNGEN

## 1. ALLGEMEINES

Für alle Lieferungen und Leistungen gelten ausschließlich die nachstehenden Verkaufs- und Lieferbedingungen. Die Lieferungen enthalten nur was deutlich auf die Auftragsbestätigung angegeben. Einkaufsbedingungen des Bestellers verpflichten den Lieferanten nur, wenn sie von dem Lieferanten ausdrücklich schriftlich anerkannt werden. Jegliche Änderungen oder Mitteilungen während der Lieferung stellen keinen Rücktritt vom Vertrag dar. Die vereinbarten Lieferbedingungen sind unverbindlich und nicht verbindlich. Die Ausführung der Lieferung kann jederzeit im Falle einer Änderung der Kapitalkonditionen des Kunden ausgesetzt werden, gemäß dem Artikel 1461 des Zivilgesetzbuches.

## 2. PREISE

Die Preise gelten ab Werk oder Lager des Lieferanten. Sie enthalten keine Gebühren oder Dienstleistungen, die nicht erwähnt werden. Die Verpackungen sind enthalten, sofern nichts anderes schriftlich vereinbart ist.

## 3. PREISÄNDERUNG

Die im Vertrag angegebenen Preise wurden auf der Grundlage der Material- und Arbeitskosten zum Zeitpunkt des Vertrags berechnet, aus Basis der betreffenden Tabelle des ANIE. Das Berechnungssystem der Kostenänderungen wird auf Basis der gültige ANIE Preisvariabilitätsklauseln durchgeführt.

## 4. ZAHLUNGEN

Wir erkennen nur Zahlungen an, die direkt an unser Haus oder an von uns autorisierte Personen geleistet werden.

## 5. EIGENTUMSVORBEHALT

Die Lieferungen bleiben Eigentum des Lieferanten bis zur vollständigen Bezahlung der Materialien, aber die Risiken übernimmt der Käufer bereits ab Lieferung. Jede Handlung des Kunden, die das Recht des verkaufenden Unternehmens auf den Weiterverkauf des Materials beeinträchtigen kann, unterliegt gesetzlichen Sanktionen.

## 6. LIEFERTERMIN

Die angegebene Lieferzeit bindet die Verkäuferfirma nicht und sie ist nicht verpflichtet, irgendeine Entschädigung für direkte oder indirekte Schäden aufgrund von Lieferverzögerungen oder Unterbrechungen oder teilweiser oder vollständiger Auflösung der Lieferung zu zahlen. Der Lieferfrist beginnt ab dem Auftragsbestätigungsdatum, und auf jeden Fall ab Zahlungseingang bis zur Bestellung, wenn dies vereinbart wurde. Es ist ein ausreichend erweitertes recht, wenn die Zahlungen nicht rechtzeitig geleistet werden, wenn der Kunde die vertraglich vereinbarten Fristen nicht rechtzeitig zur Verfügung stellt oder auf jeden Fall wenn die Ursachen unabhängig von der verkaufenden Gesellschaft auftreten, einschließlich möglicher Verzögerungen von Unterauftragnehmern.

## 7. RÜCKLIEFERUNGEN

Die Ware kann nur mit Genehmigung des Verkäufers und mit einer Mindestabschreibung von 30% zurückgegeben werden.

## 8. VERSAND

Die Ware reist auf Gefahr des Kunden, auch wenn der Versand frei Haus erfolgt

## 9. TECHNISCHE DATEN

Die gelieferten Materialien entsprechen den aktuellen CEI-Normen (wo diese zutreffen), sofern nicht besondere Anforderungen schriftlich vereinbart werden. Das Verkäuferunternehmen behält sich das Recht vor, jederzeit Änderungen an seinen Produkten vorzunehmen, wenn dies technisch angemessen erscheint. Die Zeichnungen des Verkäufers befinden sich in seinem Eigentum und können nicht ohne schriftliche Genehmigung vom Kunden an Dritte ausgeliefert oder hergestellt werden.

## 10. GARANTIE

Idealux garantiert seine Produkte für 24 Monate ab das auf dem Artikel gedruckte Herstellungsdatum. Die Garantie deckt alle Herstellungsfehler ab, egal ob mechanisch oder elektronisch. Alle Schäden, die durch falsche Handhabung und / oder falsche Verwendung, die nicht den Gebrauchsanweisungen entsprechen, verursacht werden, sind nicht in der Garantie enthalten. Die Garantie erlischt, wenn die Produkte manipuliert und / oder verändert wurden. Das fehlerhafte Produkt, für das ein Garantieanspruch erforderlich ist, kann nach eigenem Ermessen von Idealux repariert oder durch einen neuen oder überholten Zusatzartikel ersetzt werden. Die Produkte mit Mark „5 years warranty“ sind für 5 Jahre garantiert, berücksichtigen 14 Stunden pro Tag für 365 jährliche Kalendertage unter Beachtung der auf dem Produktblatt angegebenen Lebensdauer. Die Gewährleistungsansprüche innerhalb von 5 Jahren ab Herstellungsdatum (mit Ausnahme derjenigen, die innerhalb der oben angegebenen gesetzlichen Bestimmungen eingehen) unterliegen der Genehmigung von Idealux. Fehler, die in den angegebenen physiologischen Mangel fallen und in keinem Fall 5% der gesamten installierten Artikel ausmachen, sind nicht von der 5-Jahres-Garantie abgedeckt. Allgemeine Garantiebedingungen sind verfügbar und können bei Idealux angefordert werden

## 11. ERFÜLLUNGORT UND RICHTSSTAND

Die Verträge, auch wenn sie mit ausländischen Staatsbürgern oder für im Ausland geliefertes Material vereinbart werden, werden durch den aktuellen italienischen Gesetzgeber geregelt. Das zuständige Gericht ist nur das am Sitz der Verkäuferfirma zuständige Gericht, ungeachtet der Artikel 32 und der nachfolgenden Zivilprozessordnung. Für den Käufer ist die Möglichkeit ausgeschlossen, sich an die Justizbehörde eines anderen Ortes auch als Garantie oder Verbindung der Sache zu wenden, erspart jedoch der Fähigkeit des verkaufenden Unternehmens, als Schauspielerin eine Klage am Wohnort in Italien durchzuführen oder im Ausland. Die eventuellen Reklamationen entbinden den Kunden nicht von der Einhaltung der vereinbarten Zahlungsbedingungen und bedeuten keine Verlängerung der vereinbarten Termine. Die Auftragskosten, ihre Registrierung und die eventuelle Transkription trägt der Kunde.

# ОБЩИЕ УСЛОВИЯ ПРОДАЖИ

## 1. ВВОДНАЯ ЧАСТЬ

Поставки включают в себя только те условия, которые указаны в подтверждении заказа компанией-производителем, и они регулируются настоящими общими условиями продаж, за исключением отступлений, вытекающих из чётко составленного письменного договора. Возможные вариации либо коммуникации в течение процесса поставки не являются нарушением контракта. Согласованные сроки поставки являются ориентировочными и не императивными. В любой момент осуществление поставки может быть прервано в случае изменений в имущественных условиях заказчика в соответствии с Ст. 1461 гражданского кодекса.

## 2. ЦЕНЫ

Цены подразумевают самовывоз из фабрики компании-производителя. Они не включают в себя услуги и обязательства, которые не были упомянуты ранее. Упаковка входит в стоимость, за исключением иной письменной договорённости.

## 3. КОЛЕБАНИЯ ЦЕН

Цены, указанные в контракте, рассчитаны в соответствии со стоимостью материалов и рабочей силы на дату заключения контракта, в соответствии с таблицами ANIE (Федерация производителей электротехники и электроники Италии). Система расчёта возможных колебаний в большую или меньшую сторону, которые могут обнаружиться в упомянутой стоимости в течение периода осуществления продажи, будет осуществляться в соответствии с пунктами изменения действующих цен, применяемые к осветительным приборам, и опубликованные ANIE (Федерацией производителей электротехники и электроники Италии).

## 4. ФОРМА ПЛАТЕЖА

Мы принимаем только платежи, адресованные непосредственно нам либо лицам, уполномоченным нами.

## 5. ОТСРОЧКА ПЕРЕХОДА ПРАВА СОБСТВЕННОСТИ

Компания-производитель оставляет за собой право собственности на материалы до их полной оплаты, однако покупатель берёт на себя риски с момента доставки. Любое действие Заказчика, за исключением письменного согласия компании-производителя, влекущее за собой ущемление права компании-производителя на продажу материала, будет наказано в соответствии с законом.

## 6. ДОСТАВКА

Указанный срок доставки не накладывает на компанию-производителя обязательств по компенсации убытков, возникших в результате прямого или косвенного ущерба в связи с задержкой доставки либо её прекращением, а также по частичному либо полному аннулированию поставки. Срок доставки исчисляется от даты подтверждения заказа и в любом случае не ранее получения частичной оплаты заказа, когда она была согласована. Срок доставки также может быть увеличен, если оплата не была внесена в оговоренные сроки, либо в случае, если Заказчик не выполняет своевременно условий контракта, а также, если возникли причины, независимые от Компании-производителя, включающие в себя возможные задержки доставки от субподрядчиков.

## 7. ВОЗВРАТ ТОВАРА

Товар может быть возвращён исключительно с разрешения Компании-производителя с минимальным снижением стоимости в 30%.

## 8. ТРАНСПОРТИРОВКА

Отправка товара осуществляется на страх и риск Заказчика, включая возможные повреждения даже в случае отправки порто-франко. По прошествии 8 дней претензии не принимаются. Заказы выполняются в зависимости от наличия материалов на складе и отправка может также осуществляться частично.

## 9. ТЕХНИЧЕСКИЕ ХАРАКТЕРИСТИКИ

Поставляемые материалы, за исключением отдельных подлежащих письменному согласованию требований, соответствуют действующим нормам CEI (Итальянский электротехнический комитет) там, где это применимо. Компания-производитель оставляет за собой право в любой момент внести технические целесообразные изменения в свои продукты. Чертежи Компании-производителя являются её собственностью и не могут быть переданы третьим лицам без письменного разрешения, также как и её продукты.

## 10. ГАРАНТИЯ

Идеаллюкс даёт гарантию 24 месяца на свои продукты от даты изготовления, которая указана на изделии. Гарантия покрывает все дефекты производства как механического, так и электронного происхождения. В гарантию не входит ущерб, нанесённый при транспортировке и/или при ненадлежащем использовании, а также использовании отличном от описанного в руководстве по эксплуатации. Гарантия теряет силу в случае, если была нарушена целостность продукта, либо продукт был модифицирован. Неисправный продукт, для которого потребовалось гарантийное обслуживание, может быть починен, либо заменён на комплектный или новый только по безоговорочному решению Идеаллюкс. На продукты, на которых указано «гарантия 5 лет» ("5 years warranty") распространяется гарантия 5 лет с учётом работы 14ч/день в течение 365 дней в году, в соответствии со сроком службы, указанным на техпаспорте продукта. Претензии в рамках гарантийного обслуживания в течение 5 лет от даты выпуска (за исключением тех, которые были получены в течение вышеуказанных законодательных сроков) подлежат утверждению со стороны Идеаллюкс. Неисправности, которые являются в пределах заявленной нормы и составляют не более 5% от общего количества установленных единиц, не входят в гарантию 5 лет. Общие положения и условия гарантии доступны и могут быть предоставлены по запросу на фабрике Идеаллюкс.

## 11. СПОРНЫЕ ВОПРОСЫ

Контракты, заключённые с иностранными гражданами, либо доставка материалов за границу, регулируются действующим итальянским законодательством. Юрисдикция имеет подведомственность по юридическому адресу Компании-производителя независимо от ст. 32 и последующих гражданского-процессуального кодекса; для Заказчика исключена возможность подачи судебного иска либо соединения исков в иные судебные органы, даже если товар находится на гарантии, однако за Компанией-производителем оставляется право прибегать к действиям в качестве истца по месту пребывания Заказчика, в Италии либо за границей. Возможные споры не освобождают Заказчика от соблюдения согласованных условий оплаты и не предусматривают продление сроков, установленных соглашением сторон. Контрактные сборы, его регистрация и возможная перепись осуществляются за счёт Заказчика.

Catalogue **LOOKUP** 2019 <sup>1<sup>st</sup></sup> Edition

Graphics&Creativity  
Purplecloud design | William Cardani



Contents  
Ufficio tecnico | Ideallux®

LithoPrinter  
Tipolitografia PAGANI

The information and specifications are subject to changes without notice. Ideallux® reserves the right at any time at its discretion and without notice, to make changes to the products included in its catalogue. The technical data in the catalogue are valid except for errors and/or omissions. The reproduction of the material contained in this catalogue is prohibited without the written consent of Ideallux®.

*Lookup*



*Lookup*

Via Casinghino, 11  
27024 Cilavegna (PV) | Italy

Tel. +39 0381 969814  
Fax +39 0381 669709

[grupporaina@ideallux.it](mailto:grupporaina@ideallux.it)  
[www.grupporaina.it](http://www.grupporaina.it)