

OUTDOOR LIGHTING 2022

ITALIANO - ENGLISH

FLOS
OUTDOOR



FLOS
OUTDOOR

La temperatura colore 2200K è disponibile su richiesta per la maggior parte dei prodotti presenti in questo catalogo. Consultateci per verificare la disponibilità nel caso in cui sia necessaria per il vostro progetto.

The 2200K color temperature is available upon request for most of the products featured in this catalogue. Please consult us for availability in case you need more information for your lighting project.



Inground

Landlord

140



A - Round

334



A - Rise

344



Gobi

368



C - Me

390



Linear

Outgraze

414



Tau

464



Cielo

476



Landlord

140



Belvedere

196



Heavy Metal

294



Kirk

548



Spock

556



Aimer

568



Franco

602

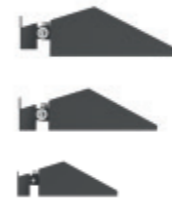

Perseo

624



Table / Floor

In Vitro Unplugged

46



Captain Flint

90



IC Lights

98



Pointbreak

16

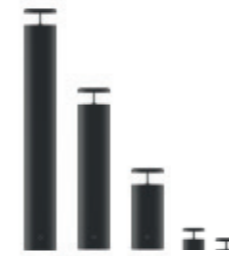

In Vitro

46



Mile

56



Caule

106

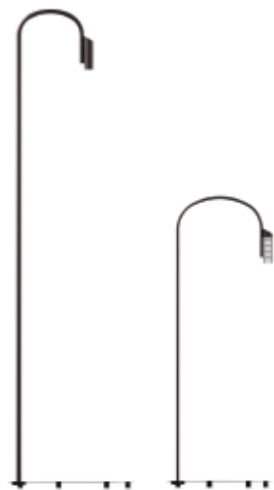

K - Tribe

132



Superarchimoon

132



Caule

106

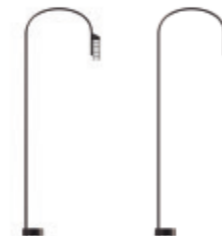

Landlord

140



Bellhop

158



Casting

170



Casting Concrete

170



Walkstick

182



Bollard

Klein Pro

208



Zefiro

218



I - Ron

228



Talia

236

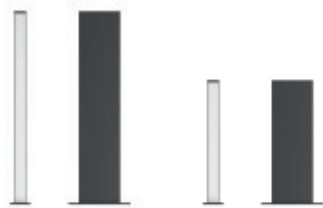

45

246



Aimer 2 Pole

568



Wall

Pointbreak

16



In Vitro

46



Mile

56



Captain Flint

90



IC Lights

98



Flauta

122



Bellhop

158



Belvedere

196



Camouflage

272



Climber

282



Heavy Metal

294



Marco

316



Wall

Platter

508



Emma Wall

520



Dooku

648



Graphic Light

Fenestra

326



Ceiling / Suspension

Pointbreak

16



In Vitro

46



Mile

56



IC Lights

98



Romeo

132



Leila

536



Platter

508



Emma Ceiling

520



Path

Mile

56



Wallstick

182



Real Matter

254



My Way

264



Gobi

368



Eclipse

488



Hyperion

498



Pole / Pole Top

Bellhop

158



Franco

602



Perseo

624



Dooku

648



Pointbreak

Designed by Piero Lissoni

Overview





Pointbreak Ballisage 2



Pointbreak Wall 1



Pointbreak Ceiling 2

Famiglia / Family

Pointbreak Bollard 1



Power Led
5,6W
274 lm - 2700K/CRI 80
285 lm - 3000K/CRI 80
307 lm - 4000K/CRI 80

Pointbreak Balisage 1



Power Led
5,6W
274 lm - 2700K/CRI 80
285 lm - 3000K/CRI 80
307 lm - 4000K/CRI 80

Pointbreak Bollard 2



Power Led
12,5W
600 lm - 2700K/CRI 80
624 lm - 3000K/CRI 80
672 lm - 4000K/CRI 80

Pointbreak Balisage 2



Power Led
12,5W
600 lm - 2700K/CRI 80
624 lm - 3000K/CRI 80
672 lm - 4000K/CRI 80

Colori / Colours



01 White



06 Grey



12 Forest Green

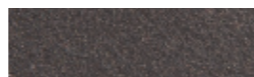

18 Deep Brown



30 Black



33 Anthracite

Famiglia / Family

Pointbreak Wall 0



Power Led
2,2W
up to 101 lm - 2700K/CRI 80
up to 108 lm - 3000K/CRI 80
up to 112 lm - 4000K/CRI 80

Power Led
3,4W
up to 2x101 lm - 2700K/CRI 80
up to 2x108 lm - 3000K/CRI 80
up to 2x112 lm - 4000K/CRI 80

Pointbreak Wall 1



Power Led
6,5W
357 lm - 2700K/CRI 80
375 lm - 3000K/CRI 80
393 lm - 4000K/CRI 80

Power Led
12W
2x357 lm - 2700K/CRI 80
2x375 lm - 3000K/CRI 80
2x393 lm - 4000K/CRI 80

Pointbreak Wall 2



Power Led
17,5W
1316 lm - 2700K/CRI 80
1365 lm - 3000K/CRI 80
1414 lm - 4000K/CRI 80

Power Led
32W
2x1316 lm - 2700K/CRI 80
2x1365 lm - 3000K/CRI 80
2x1414 lm - 4000K/CRI 80

Pointbreak Ceiling 0



Power Led
2,2W
up to 101 lm - 2700K/CRI 80
up to 108 lm - 3000K/CRI 80
up to 112 lm - 4000K/CRI 80

Pointbreak Ceiling 1



Power Led
6,5W
357 lm - 2700K/CRI 80
375 lm - 3000K/CRI 80
393 lm - 4000K/CRI 80

Pointbreak Ceiling 2



Power Led
17,5W
1316 lm - 2700K/CRI 80
1365 lm - 3000K/CRI 80
1414 lm - 4000K/CRI 80

Descrizione

Pointbreak Bollard

Collezione di bollard per esterno dal ricco contenuto di design con sorgente luminosa a LED, caratterizzati dall'ottica ad altissima performance.

L'esclusiva forma supercerchio è declinata in due dimensioni e tre altezze. Struttura corpo in alluminio estruso, testa dell'apparecchio in fusione di alluminio, diffusore in policarbonato trasparente trattato superficialmente con antigraffio e stabilizzato ai raggi UV. L'ottica integrata nella testa permette una emissione luminosa asimmetrica radiale direzionata verso il basso e combinata con il riflettore in alluminio verniciato in nero assoluto evitano le riflessioni indirette per rispettare le vigenti leggi in materia di inquinamento luminoso.

Disponibile in differenti finiture con rivestimento a doppio strato di polveri e sottoposte a trattamento di conversione chimica superficiale per una elevata resistenza alla corrosione.

Le versioni bollard possono essere installate facilmente a terra su qualsiasi pavimento con tasselli tramite base in tecnopolimero ad altissima resistenza ed esente da fenomeno di corrosione ed elemento di fissaggio che ne permette la regolazione fine, oppure utilizzando l'accessorio dedicato piastra di ancoraggio per rendere la base del prodotto totalmente solidale con la pavimentazione. Le viterie di fissaggio del paletto sono in acciaio inox AISI 316L brunite per le finiture scure.

Pointbreak Balisage

Collezione di apparecchi semincasso balisage per esterno dal ricco contenuto di design con sorgente luminosa a LED, caratterizzati dall'ottica ad altissima performance.

L'esclusiva forma del supercerchio è declinata in due dimensioni e due altezze. Struttura corpo in alluminio estruso, testa dell'apparecchio in fusione di alluminio, diffusore in policarbonato trasparente trattato superficialmente con antigraffio e stabilizzato ai raggi UV. L'ottica integrata nella testa permette una emissione luminosa asimmetrica radiale direzionata verso il basso e combinata con il riflettore in alluminio verniciato in nero assoluto evitano le riflessioni indirette per rispettare le vigenti leggi in materia di inquinamento luminoso.

Disponibile in differenti finiture con rivestimento a doppio strato di polveri e sottoposte a trattamento di conversione chimica superficiale per una elevata resistenza alla corrosione.

Trattamento brevettato ACT (anti corrosion treatment) per la parte incassata nel terreno.

Le versioni balisage possono essere installate facilmente nel terreno mediante l'utilizzo di apposita cassaforma obbligatoria, da ordinare separatamente.

Pointbreak Wall

Collezione di apparecchi a parete per esterno dal ricco contenuto di design con sorgente luminosa a LED, caratterizzati dall'ottica ad altissima performance.

L'esclusiva forma del supercerchio è declinata in due dimensioni, ad emissione monodirezionale o bidirezionale. Struttura in fusione di alluminio con vetro trasparente di chiusura. L'ottica integrata, arretrata nella parte inferiore, utilizza lenti brevettate ed è protetta da una schermatura in nero assoluto, per ottimizzare il confort visivo e contemporaneamente mantenere una elevata performance. Disponibile in differenti finiture con rivestimento a doppio strato di polveri e sottoposte a trattamento di conversione chimica superficiale per una elevata resistenza alla corrosione.

L'installazione viene effettuata tramite staffa in PBT (Poli-butilene tereftalato) ad altissima resistenza ed esente da fenomeno di corrosione. Doppio pressacavo installato direttamente sul corpo dell'apparecchio per consentire il cablaggio entra-esci.

Pointbreak Ceiling

Collezione di apparecchi a soffitto per esterno dal ricco contenuto di design con sorgente luminosa a LED, caratterizzati dall'ottica ad altissima performance.

L'esclusiva forma del supercerchio è declinata in due dimensioni. Struttura in fusione di alluminio, con vetro trasparente di chiusura. L'ottica integrata, arretrata nella parte inferiore, utilizza lenti brevettate ed è protetta da una schermatura in nero assoluto, per ottimizzare il confort visivo e contemporaneamente mantenere una elevata performance. Disponibile in differenti finiture con rivestimento a doppio strato di polveri e sottoposte a trattamento di conversione chimica superficiale per una elevata resistenza alla corrosione.

L'installazione viene effettuata tramite elemento di fissaggio che ne permette la regolazione fine. Doppio pressacavo installato direttamente sul corpo dell'apparecchio per consentire il cablaggio entra-esci.

Description

Pointbreak Bollard

Collection of outdoor bollards with an exclusive design and LED light source, characterized by high-performance optics. The unique squircle shape is available in two sizes and three heights. The body structure comes in extruded aluminum, the head of the luminaire in cast aluminum, and the diffuser is made of transparent, UV-stabilized polycarbonate with scratch-resistant surface treatment. The optics integrated in the head allows an asymmetric, downward radial light emission that, combined with an aluminum reflector painted in absolute black, avoids indirect reflections in compliance with current light pollution laws.

Available in different finishes with a double layer of powder coating and chemical conversion surface treatment to ensure high resistance against corrosion.

Bollard versions may be easily installed on any flooring on the ground with anchors by using the high-resistance, corrosion-free technopolymer base and a fixing element, allowing a fine adjustment; or by using the specific accessory anchoring plate for a flawless integration of the base of the product with the ground. The anchoring hardware is made of AISI 316L burnished for dark finishes.

Pointbreak Balisage

Collection of partially-recessed outdoor luminaires with an exclusive design and LED light source, characterized by high-performance optics.

The unique squircle shape is available in two sizes and three heights. The body structure comes in extruded aluminum, the head of the luminaire in cast aluminum, and the diffuser is made of transparent, UV-stabilized polycarbonate with scratch-resistant surface treatment. The optics integrated in the head allows an asymmetric, downward radial light emission that, combined with an aluminum reflector painted in absolute black, avoids indirect reflections in compliance with current light pollution laws.

Available in different finishes with a double layer of powder coating and chemical conversion surface treatment to ensure high resistance against corrosion.

Patented anticorrosive treatment (ACT) for the part fitted into the ground.

Balisage versions are easily installed on the ground with a mandatory special box for installation, to be ordered separately.

Pointbreak Wall

Collection of outdoor wall luminaires with an exclusive design and LED light source, characterized by high-performance optics.

The unique squircle shape is available in two sizes, with uni- or bi-directional emission. Cast aluminum structure with transparent closing glass. The integrated optics, located at the bottom, uses patented lenses and is protected by an absolute black screening to optimize visual comfort while maintaining high performance.

Available in different finishes with a double layer of powder coating and chemical conversion surface treatment to ensure high resistance against corrosion.

The installation is made using a highly resistant and corrosion-free PBT (polybutylenterephthalate) bracket. Double cable gland installed directly in the body of the luminaire for inlet and outlet connection.

Pointbreak Ceiling

Collection of outdoor ceiling luminaires with an exclusive design and LED light source, characterized by high-performance optics.

The unique squircle shape is available in two sizes. Cast aluminum structure with transparent closing glass. The integrated optics, located at the bottom, uses patented lenses and is protected by an absolute black screening to optimize visual comfort while maintaining high performance.

Available in different finishes with a double layer of powder coating and chemical conversion surface treatment to ensure high resistance against corrosion.

Installation is made with a fixing component that allows a fine adjustment. Double cable gland installed directly in the body of the luminaire for inlet and outlet connection.

Pointbreak Bollard 1 - 300

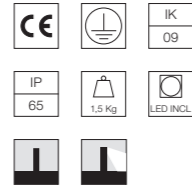
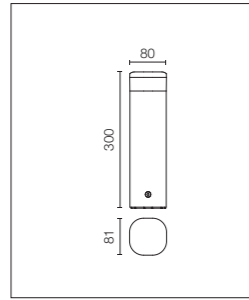

Sorgente luminosa a LED inclusa. Alimentazione elettrica 220-240V ON/OFF e dimmerabile 1-10V o DALI integrata. Dotato di uno spezzone di cavo uscente in neoprene. Sistema di giunzione IP68 da ordinare separatamente. L'apparecchio è installabile su qualsiasi pavimento per mezzo di tasselli. Piastra di ancoraggio per l'installazione su pavimentazione da gettare con plinto di cemento da ordinare separatamente.

LED light source included. Integrated 220-240V ON/OFF and 1-10V/DALI dimmable electrical power. Equipped with one piece of neoprene output cable. IP68 junction system to be ordered separately. The luminaire may be easily installed on any type of floor with anchors. The anchoring plate for installation on flooring to be concreted must be ordered separately.

Mid - Power Led: 5,6W - 576 lm ≠ FIXT 274 lm - 2700K/CRI>80 - 220-240V / 5,6W - 600 lm ≠ FIXT 285 lm - 3000K/CRI>80 - 220-240V / 5,6W - 625 lm ≠ FIXT 307 lm - 4000/CRI>80 - 220-240V

2700K

- Non Dimmable
- F023E2AA001
 - F023E2AA006
 - F023E2AA012
 - F023E2AA018
 - F023E2AA030
 - F023E2AA033
- 1-10V
- F023E2AB001
 - F023E2AB006
 - F023E2AB012
 - F023E2AB018
 - F023E2AB030
 - F023E2AB033
- Dali
- F023E2AD001
 - F023E2AD006
 - F023E2AD012
 - F023E2AD018
 - F023E2AD030
 - F023E2AD033

3000K

- Non Dimmable
- F023E3AA001
 - F023E3AA006
 - F023E3AA012
 - F023E3AA018
 - F023E3AA030
 - F023E3AA033
- 1-10V
- F023E3AB001
 - F023E3AB006
 - F023E3AB012
 - F023E3AB018
 - F023E3AB030
 - F023E3AB033
- Dali
- F023E3AD001
 - F023E3AD006
 - F023E3AD012
 - F023E3AD018
 - F023E3AD030
 - F023E3AD033

4000K

- Non Dimmable
- F023E4AA001
 - F023E4AA006
 - F023E4AA012
 - F023E4AA018
 - F023E4AA030
 - F023E4AA033
- 1-10V
- F023E4AB001
 - F023E4AB006
 - F023E4AB012
 - F023E4AB018
 - F023E4AB030
 - F023E4AB033
- Dali
- F023E4AD001
 - F023E4AD006
 - F023E4AD012
 - F023E4AD018
 - F023E4AD030
 - F023E4AD033

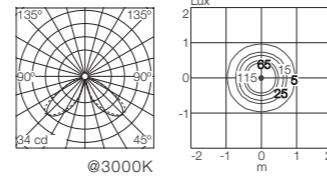

Pointbreak Bollard 1 - 900

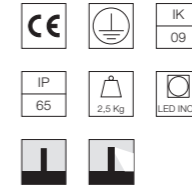
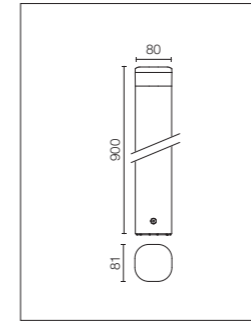

Sorgente luminosa a LED inclusa. Alimentazione elettrica 220-240V ON/OFF e dimmerabile 1-10V o DALI integrata. Dotato di uno spezzone di cavo uscente in neoprene. Sistema di giunzione IP68 da ordinare separatamente. L'apparecchio è installabile su qualsiasi pavimento per mezzo di tasselli. Piastra di ancoraggio per l'installazione su pavimentazione da gettare con plinto di cemento da ordinare separatamente.

LED light source included. Integrated 220-240V ON/OFF and 1-10V/DALI dimmable electrical power. Equipped with one piece of neoprene output cable. IP68 junction system to be ordered separately. The luminaire may be easily installed on any type of floor with anchors. The anchoring plate for installation on flooring to be concreted must be ordered separately.

Mid - Power Led: 5,6W - 576 lm ≠ FIXT 274 lm - 2700K/CRI>80 - 220-240V / 5,6W - 600 lm ≠ FIXT 285 lm - 3000K/CRI>80 - 220-240V / 5,6W - 625 lm ≠ FIXT 307 lm - 4000/CRI>80 - 220-240V

2700K

- Non Dimmable
- F023E2CA001
 - F023E2CA006
 - F023E2CA012
 - F023E2CA018
 - F023E2CA030
 - F023E2CA033
- 1-10V
- F023E2CB001
 - F023E2CB006
 - F023E2CB012
 - F023E2CB018
 - F023E2CB030
 - F023E2CB033
- Dali
- F023E2CD001
 - F023E2CD006
 - F023E2CD012
 - F023E2CD018
 - F023E2CD030
 - F023E2CD033

3000K

- Non Dimmable
- F023E3CA001
 - F023E3CA006
 - F023E3CA012
 - F023E3CA018
 - F023E3CA030
 - F023E3CA033
- 1-10V
- F023E3CB001
 - F023E3CB006
 - F023E3CB012
 - F023E3CB018
 - F023E3CB030
 - F023E3CB033
- Dali
- F023E3CD001
 - F023E3CD006
 - F023E3CD012
 - F023E3CD018
 - F023E3CD030
 - F023E3CD033

4000K

- Non Dimmable
- F023E4CA001
 - F023E4CA006
 - F023E4CA012
 - F023E4CA018
 - F023E4CA030
 - F023E4CA033
- 1-10V
- F023E4CB001
 - F023E4CB006
 - F023E4CB012
 - F023E4CB018
 - F023E4CB030
 - F023E4CB033
- Dali
- F023E4CD001
 - F023E4CD006
 - F023E4CD012
 - F023E4CD018
 - F023E4CD030
 - F023E4CD033

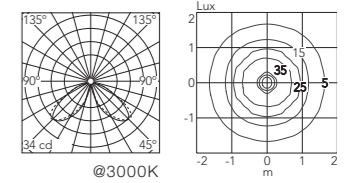

Pointbreak Bollard 1 - 600

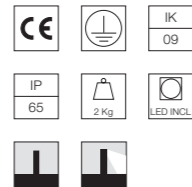
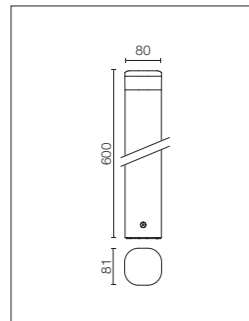

Sorgente luminosa a LED inclusa. Alimentazione elettrica 220-240V ON/OFF e dimmerabile 1-10V o DALI integrata. Dotato di uno spezzone di cavo uscente in neoprene. Sistema di giunzione IP68 da ordinare separatamente. L'apparecchio è installabile su qualsiasi pavimento per mezzo di tasselli. Piastra di ancoraggio per l'installazione su pavimentazione da gettare con plinto di cemento da ordinare separatamente.

LED light source included. Integrated 220-240V ON/OFF and 1-10V/DALI dimmable electrical power. Equipped with one piece of neoprene output cable. IP68 junction system to be ordered separately. The luminaire may be easily installed on any type of floor with anchors. The anchoring plate for installation on flooring to be concreted must be ordered separately.

Mid - Power Led: 5,6W - 576 lm ≠ FIXT 274 lm - 2700K/CRI>80 - 220-240V / 5,6W - 600 lm ≠ FIXT 285 lm - 3000K/CRI>80 - 220-240V / 5,6W - 625 lm ≠ FIXT 307 lm - 4000/CRI>80 - 220-240V

2700K

- Non Dimmable
- F023E2BA001
 - F023E2BA006
 - F023E2BA012
 - F023E2BA018
 - F023E2BA030
 - F023E2BA033
- 1-10V
- F023E2BB001
 - F023E2BB006
 - F023E2BB012
 - F023E2BB018
 - F023E2BB030
 - F023E2BB033
- Dali
- F023E2BD001
 - F023E2BD006
 - F023E2BD012
 - F023E2BD018
 - F023E2BD030
 - F023E2BD033

3000K

- Non Dimmable
- F023E3BA001
 - F023E3BA006
 - F023E3BA012
 - F023E3BA018
 - F023E3BA030
 - F023E3BA033
- 1-10V
- F023E3BB001
 - F023E3BB006
 - F023E3BB012
 - F023E3BB018
 - F023E3BB030
 - F023E3BB033
- Dali
- F023E3BD001
 - F023E3BD006
 - F023E3BD012
 - F023E3BD018
 - F023E3BD030
 - F023E3BD033

4000K

- Non Dimmable
- F023E4BA001
 - F023E4BA006
 - F023E4BA012
 - F023E4BA018
 - F023E4BA030
 - F023E4BA033
- 1-10V
- F023E4BB001
 - F023E4BB006
 - F023E4BB012
 - F023E4BB018
 - F023E4BB030
 - F023E4BB033
- Dali
- F023E4BD001
 - F023E4BD006
 - F023E4BD012
 - F023E4BD018
 - F023E4BD030
 - F023E4BD033

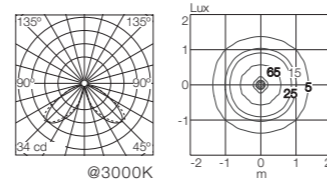

Pointbreak Mono Emission 180°

Pointbreak Bollard è anche disponibile in versione mono emissione (180°) grazie ad uno speciale otturatore sagomato integrato nel gruppo ottico stagno.

Su richiesta l'emissione può essere modificata per ottenere un'apertura di 90° o 270°.

Pointbreak Bollard is also available as a single-emission version (180°) thanks to a special shaped shutter integrated in the watertight optical unit.

On request, the beam can be modified to 90° or 270°.



* Dati tecnici e fotometrie preliminari. / Preliminary technical specs and photometries.

Pointbreak: Accessori / Accessories

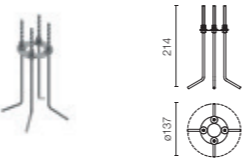
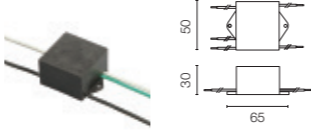
Piastra tirafondi.	Base plate with bolt.	Pointbreak Bollard 1 F023Z050000	
Dispositivo di protezione per il sovraccarico. 275 Vac. Corrente massima di scarica 10KA (8/29us). Massima corrente operativa 5A. Adatto per la connessione in serie. IP66.	Surge protection device. 275Vac. Maximum discharge current 10KA (8/20us). Maximum operating current 5A. Suitable for series connection. IP66.	Pointbreak Bollard F990E00A000	

Pointbreak: Accessori per versioni non dimmable / Accessories for non-dimmable versions

Sistema di giunzione IP68 H2O Stop anti-condensa a 2 vie 4 poli.	2 way terminal block 4 poles IP68 H2O Stop.	F990C00A000	
Sistema di giunzione IP68 H2O Stop anti-condensa a 3/4 vie 4 poli. (Ø5,5±12mm cavo).	3/4 way terminal block 4 poles IP68 H2O Stop. (Ø5,5±12mm cable).	F990C010000	





Pointbreak: Accessori per versioni Dimmerabili / Accessories for dimmable versions

Kit connettore 5 poli presa volante + spina EU IP68.	Connector kit 5-pole flying socket + EU plug IP68.	F990C080000	
Scatola di derivazione 5 poli 4 vie IP68 (cavi 6-14 mm).	4 way junction box 5 poles IP68 (6-14 mm cables).	F990C030000	

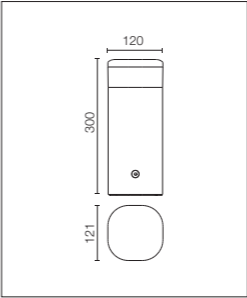
Pointbreak Bollard 2 - 300





Sorgente luminosa a LED inclusa. Alimentazione elettrica 220-240V ON/OFF e dimmerabile 1-10V o DALI integrata. Dotato di uno spezzone di cavo uscente in neoprene. Sistema di giunzione IP68 da ordinare separatamente. L'apparecchio è installabile su qualsiasi pavimento per mezzo di tasselli. Piastra di ancoraggio per l'installazione su pavimentazione da gettare con plinto di cemento da ordinare separatamente.

LED light source included. Integrated 220-240V ON/OFF and 1-10V/DALI dimmable electrical power. Equipped with one piece of neoprene output cable. IP68 junction system to be ordered separately. The luminaire may be easily installed on any type of floor with anchors. The anchoring plate for installation on flooring to be concreted must be ordered separately.

Mid - Power Led: 12,5W - 1374 lm ≠ FIXT 600 lm - 2700K/CRI>80 - 220-240V / 12,5W - 1429 lm ≠ FIXT 624 lm - 3000K/CRI>80 - 220-240V / 12,5W - 1538 lm ≠ FIXT 672 lm - 4000/CRI>80 - 220-240V

2700K
Non Dimmable

- F023F2AA001
- F023F2AA006
- F023F2AA012
- F023F2AA018
- F023F2AA030
- F023F2AA033
- F023F2AB001
- F023F2AB006
- F023F2AB012
- F023F2AB018
- F023F2AB030
- F023F2AB033
- F023F2AD001
- F023F2AD006
- F023F2AD012
- F023F2AD018
- F023F2AD030
- F023F2AD033

3000K
Non Dimmable

- F023F3AA001
- F023F3AA006
- F023F3AA012
- F023F3AA018
- F023F3AA030
- F023F3AA033
- F023F3AB001
- F023F3AB006
- F023F3AB012
- F023F3AB018
- F023F3AB030
- F023F3AB033
- F023F3AD001
- F023F3AD006
- F023F3AD012
- F023F3AD018
- F023F3AD030
- F023F3AD033

4000K
Non Dimmable



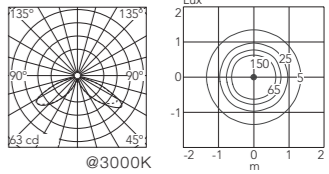

- F023F4AA001
- F023F4AA006
- F023F4AA012
- F023F4AA018
- F023F4AA030
- F023F4AA033
- F023F4AB001
- F023F4AB006
- F023F4AB012
- F023F4AB018
- F023F4AB030
- F023F4AB033
- F023F4AD001
- F023F4AD006
- F023F4AD012
- F023F4AD018
- F023F4AD030
- F023F4AD033

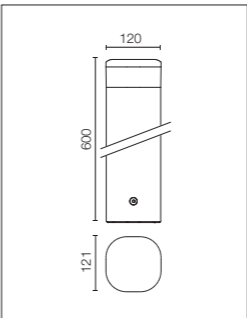

Pointbreak Bollard 2 - 600





Sorgente luminosa a LED inclusa. Alimentazione elettrica 220-240V ON/OFF e dimmerabile 1-10V o DALI integrata. Dotato di uno spezzone di cavo uscente in neoprene. Sistema di giunzione IP68 da ordinare separatamente. L'apparecchio è installabile su qualsiasi pavimento per mezzo di tasselli. Piastra di ancoraggio per l'installazione su pavimentazione da gettare con plinto di cemento da ordinare separatamente.

LED light source included. Integrated 220-240V ON/OFF and 1-10V/DALI dimmable electrical power. Equipped with one piece of neoprene output cable. IP68 junction system to be ordered separately. The luminaire may be easily installed on any type of floor with anchors. The anchoring plate for installation on flooring to be concreted must be ordered separately.

Mid - Power Led: 12,5W - 1374 lm ≠ FIXT 600 lm - 2700K/CRI>80 - 220-240V / 12,5W - 1429 lm ≠ FIXT 624 lm - 3000K/CRI>80 - 220-240V / 12,5W - 1538 lm ≠ FIXT 672 lm - 4000/CRI>80 - 220-240V

2700K
Non Dimmable

- F023F2BA001
- F023F2BA006
- F023F2BA012
- F023F2BA018
- F023F2BA030
- F023F2BA033
- F023F2BB001
- F023F2BB006
- F023F2BB012
- F023F2BB018
- F023F2BB030
- F023F2BB033
- F023F2BD001
- F023F2BD006
- F023F2BD012
- F023F2BD018
- F023F2BD030
- F023F2BD033

3000K
Non Dimmable

- F023F3BA001
- F023F3BA006
- F023F3BA012
- F023F3BA018
- F023F3BA030
- F023F3BA033
- F023F3BB001
- F023F3BB006
- F023F3BB012
- F023F3BB018
- F023F3BB030
- F023F3BB033
- F023F3BD001
- F023F3BD006
- F023F3BD012
- F023F3BD018
- F023F3BD030
- F023F3BD033

4000K
Non Dimmable

- F023F4BA001
- F023F4BA006
- F023F4BA012
- F023F4BA018
- F023F4BA030
- F023F4BA033
- F023F4BB001
- F023F4BB006
- F023F4BB012
- F023F4BB018
- F023F4BB030
- F023F4BB033
- F023F4BD001
- F023F4BD006
- F023F4BD012
- F023F4BD018
- F023F4BD030
- F023F4BD033

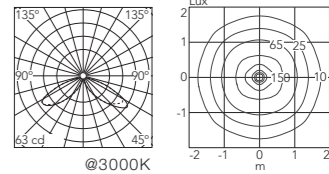

Pointbreak Bollard 2 - 900

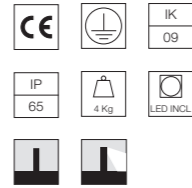
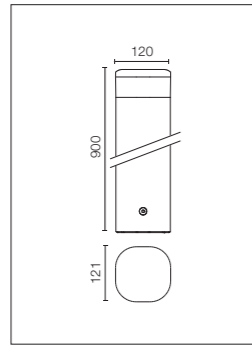

Sorgente luminosa a LED inclusa. Alimentazione elettrica 220-240V ON/OFF e dimmerabile 1-10V o DALI integrata. Dotato di uno spezzone di cavo uscente in neoprene. Sistema di giunzione IP68 da ordinare separatamente. L'apparecchio è installabile su qualsiasi pavimento per mezzo di tasselli. Piastra di ancoraggio per l'installazione su pavimentazione da gettare con plinto di cemento da ordinare separatamente.

LED light source included. Integrated 220-240V ON/OFF and 1-10V/DALI dimmable electrical power. Equipped with one piece of neoprene output cable. IP68 junction system to be ordered separately. The luminaire may be easily installed on any type of floor with anchors. The anchoring plate for installation on flooring to be concreted must be ordered separately.

Mid - Power Led: 12,5W - 1374 lm = FIXT 600 lm - 2700K/CRI>80 - 220-240V / 12,5W - 1429 lm = FIXT 624 lm - 3000K/CRI>80 - 220-240V / 12,5W - 1538 lm = FIXT 672 lm - 4000/CRI>80 - 220-240V

- | | | |
|--|--|--|
| <p>2700K
Non Dimmable</p> <ul style="list-style-type: none"> ○ F023F2CA001 ● F023F2CA006 ● F023F2CA012 ● F023F2CA018 ● F023F2CA030 ● F023F2CA033 <p>1-10V</p> <ul style="list-style-type: none"> ○ F023F2CB001 ● F023F2CB006 ● F023F2CB012 ● F023F2CB018 ● F023F2CB030 ● F023F2CB033 <p>Dali</p> <ul style="list-style-type: none"> ○ F023F2CD001 ● F023F2CD006 ● F023F2CD012 ● F023F2CD018 ● F023F2CD030 ● F023F2CD033 | <p>3000K
Non Dimmable</p> <ul style="list-style-type: none"> ○ F023F3CA001 ● F023F3CA006 ● F023F3CA012 ● F023F3CA018 ● F023F3CA030 ● F023F3CA033 <p>1-10V</p> <ul style="list-style-type: none"> ○ F023F3CB001 ● F023F3CB006 ● F023F3CB012 ● F023F3CB018 ● F023F3CB030 ● F023F3CB033 <p>Dali</p> <ul style="list-style-type: none"> ○ F023F3CD001 ● F023F3CD006 ● F023F3CD012 ● F023F3CD018 ● F023F3CD030 ● F023F3CD033 | <p>4000K
Non Dimmable</p> <ul style="list-style-type: none"> ○ F023F4CA001 ● F023F4CA006 ● F023F4CA012 ● F023F4CA018 ● F023F4CA030 ● F023F4CA033 <p>1-10V</p> <ul style="list-style-type: none"> ○ F023F4CB001 ● F023F4CB006 ● F023F4CB012 ● F023F4CB018 ● F023F4CB030 ● F023F4CB033 <p>Dali</p> <ul style="list-style-type: none"> ○ F023F4CD001 ● F023F4CD006 ● F023F4CD012 ● F023F4CD018 ● F023F4CD030 ● F023F4CD033 |
|--|--|--|

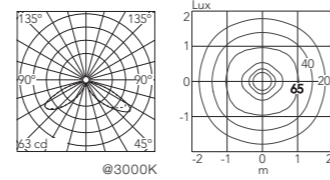

Pointbreak Mono Emission 180°

Pointbreak Bollard è anche disponibile in versione mono emissione (180°) grazie ad uno speciale otturatore sagomato integrato nel gruppo ottico stagno.

Su richiesta l'emissione può essere modificata per ottenere un'apertura di 90° o 270°.

Pointbreak Bollard is also available as a single-emission version (180°) thanks to a special shaped shutter integrated in the watertight optical unit.

On request, the beam can be modified to 90° or 270°.



Pointbreak: Accessori / Accessories

Piastra tirafondi.	Base plate with bolt.	Pointbreak Bollard 2 F023Z060000	
Dispositivo di protezione per il sovraccarico. 275 Vac. Corrente massima di scarica 10KA (8/29us). Massima corrente operativa 5A. Adatto per la connessione in serie. IP66.	Surge protection device. 275Vac. Maximum discharge current 10KA (8/20us). Maximum operating current 5A. Suitable for series connection. IP66.	Pointbreak Bollard F990E00A000	

Pointbreak: Accessori per versioni non dimmabili / Accessories for non-dimmable versions

Sistema di giunzione IP68 H2O Stop anti-condensa a 2 vie 4 poli.	2 way terminal block 4 poles IP68 H2O Stop.	F990C00A000	
Sistema di giunzione IP68 H2O Stop anti-condensa a 3/4 vie 4 poli. (Ø5,5÷12mm cavo).	3/4 way terminal block 4 poles IP68 H2O Stop. (ø5,5÷12mm cable).	F990C010000	

Pointbreak: Accessori per versioni Dimmerabili / Accessories for dimmable versions

Kit connettore 5 poli presa volante + spina EU IP68.	Connector kit 5-pole flying socket + EU plug IP68.	F990C080000	
Scatola di derivazione 5 poli 4 vie IP68 (cavi 6-14 mm).	4 way junction box 5 poles IP68 (6-14 mm cables).	F990C030000	

* Dati tecnici e fotometrie preliminari. / Preliminary technical specs and photometries.

Pointbreak Balisage 1 - 40

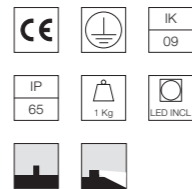
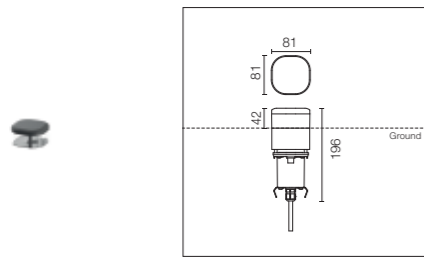

Sorgente luminosa a LED inclusa. Alimentazione elettrica 220-240V ON/OFF e dimmerabile 1-10V o DALI integrata. Dotato di uno spezzone di cavo uscente in neoprene. Sistema di giunzione IP68 da ordinare separatamente. L'apparecchio è installabile con cassaforma obbligatoria da ordinare separatamente.

LED light source included. Integrated 220-240V ON/OFF and 1-10V/DALI dimmable electrical power. Equipped with one piece of neoprene output cable. IP68 junction system to be ordered separately. Luminaire must be installed with mandatory box for installation, ordered separately.

Mid - Power Led: 5,6W - 576 lm ≠ FIXT 274 lm - 2700K/CRI>80 - 220-240V / 5,6W - 600 lm ≠ FIXT 285 lm - 3000K/CRI>80 - 220-240V / 5,6W - 625 lm ≠ FIXT 307 lm - 4000/CRI>80 - 220-240V

- | | | |
|--|--|--|
| <p>2700K
Non Dimmable</p> <ul style="list-style-type: none"> ○ F023B2AA001 ● F023B2AA006 ● F023B2AA012 ● F023B2AA018 ● F023B2AA030 ● F023B2AA033 <p>1-10V</p> <ul style="list-style-type: none"> ○ F023B2AB001 ● F023B2AB006 ● F023B2AB012 ● F023B2AB018 ● F023B2AB030 ● F023B2AB033 <p>Dali</p> <ul style="list-style-type: none"> ○ F023B2AD001 ● F023B2AD006 ● F023B2AD012 ● F023B2AD018 ● F023B2AD030 ● F023B2AD033 | <p>3000K
Non Dimmable</p> <ul style="list-style-type: none"> ○ F023B3AA001 ● F023B3AA006 ● F023B3AA012 ● F023B3AA018 ● F023B3AA030 ● F023B3AA033 <p>1-10V</p> <ul style="list-style-type: none"> ○ F023B3AB001 ● F023B3AB006 ● F023B3AB012 ● F023B3AB018 ● F023B3AB030 ● F023B3AB033 <p>Dali</p> <ul style="list-style-type: none"> ○ F023B3AD001 ● F023B3AD006 ● F023B3AD012 ● F023B3AD018 ● F023B3AD030 ● F023B3AD033 | <p>4000K
Non Dimmable</p> <ul style="list-style-type: none"> ○ F023B4AA001 ● F023B4AA006 ● F023B4AA012 ● F023B4AA018 ● F023B4AA030 ● F023B4AA033 <p>1-10V</p> <ul style="list-style-type: none"> ○ F023B4AB001 ● F023B4AB006 ● F023B4AB012 ● F023B4AB018 ● F023B4AB030 ● F023B4AB033 <p>Dali</p> <ul style="list-style-type: none"> ○ F023B4AD001 ● F023B4AD006 ● F023B4AD012 ● F023B4AD018 ● F023B4AD030 ● F023B4AD033 |
|--|--|--|

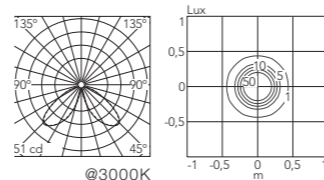

Cassaforma per l'installazione a terra / Box for ground installation.

F023Z020000



Pointbreak Balisage 1 - 80

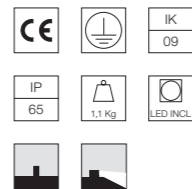
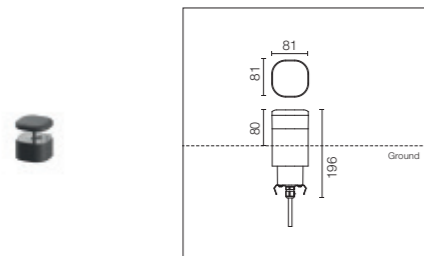

Sorgente luminosa a LED inclusa. Alimentazione elettrica 220-240V ON/OFF e dimmerabile 1-10V o DALI integrata. Dotato di uno spezzone di cavo uscente in neoprene. Sistema di giunzione IP68 da ordinare separatamente. L'apparecchio è installabile con cassaforma obbligatoria da ordinare separatamente.

LED light source included. Integrated 220-240V ON/OFF and 1-10V/DALI dimmable electrical power. Equipped with one piece of neoprene output cable. IP68 junction system to be ordered separately. Luminaire must be installed with mandatory box for installation, ordered separately.

Mid - Power Led: 5,6W - 576 lm ≠ FIXT 274 lm - 2700K/CRI>80 - 220-240V / 5,6W - 600 lm ≠ FIXT 285 lm - 3000K/CRI>80 - 220-240V / 5,6W - 625 lm ≠ FIXT 307 lm - 4000/CRI>80 - 220-240V

- | | | |
|--|--|--|
| <p>2700K
Non Dimmable</p> <ul style="list-style-type: none"> ○ F023B2BA001 ● F023B2BA006 ● F023B2BA012 ● F023B2BA018 ● F023B2BA030 ● F023B2BA033 <p>1-10V</p> <ul style="list-style-type: none"> ○ F023B2BB001 ● F023B2BB006 ● F023B2BB012 ● F023B2BB018 ● F023B2BB030 ● F023B2BB033 <p>Dali</p> <ul style="list-style-type: none"> ○ F023B2BD001 ● F023B2BD006 ● F023B2BD012 ● F023B2BD018 ● F023B2BD030 ● F023B2BD033 | <p>3000K
Non Dimmable</p> <ul style="list-style-type: none"> ○ F023B3BA001 ● F023B3BA006 ● F023B3BA012 ● F023B3BA018 ● F023B3BA030 ● F023B3BA033 <p>1-10V</p> <ul style="list-style-type: none"> ○ F023B3BB001 ● F023B3BB006 ● F023B3BB012 ● F023B3BB018 ● F023B3BB030 ● F023B3BB033 <p>Dali</p> <ul style="list-style-type: none"> ○ F023B3BD001 ● F023B3BD006 ● F023B3BD012 ● F023B3BD018 ● F023B3BD030 ● F023B3BD033 | <p>4000K
Non Dimmable</p> <ul style="list-style-type: none"> ○ F023B4BA001 ● F023B4BA006 ● F023B4BA012 ● F023B4BA018 ● F023B4BA030 ● F023B4BA033 <p>1-10V</p> <ul style="list-style-type: none"> ○ F023B4BB001 ● F023B4BB006 ● F023B4BB012 ● F023B4BB018 ● F023B4BB030 ● F023B4BB033 <p>Dali</p> <ul style="list-style-type: none"> ○ F023B4BD001 ● F023B4BD006 ● F023B4BD012 ● F023B4BD018 ● F023B4BD030 ● F023B4BD033 |
|--|--|--|

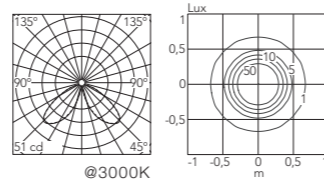

Cassaforma per l'installazione a terra / Box for ground installation.

F023Z020000



* Dati tecnici e fotometrie preliminari. / Preliminary technical specs and photometries.

Pointbreak Balisage 2 - 60

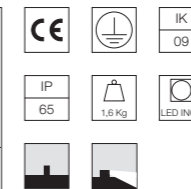
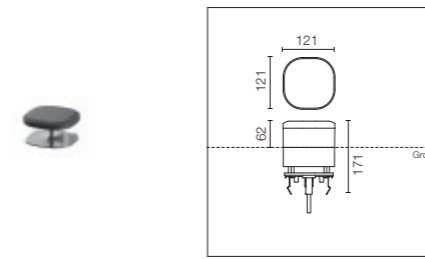

Sorgente luminosa a LED inclusa. Alimentazione elettrica 220-240V ON/OFF e dimmerabile 1-10V o DALI integrata. Dotato di uno spezzone di cavo uscente in neoprene. Sistema di giunzione IP68 da ordinare separatamente. L'apparecchio è installabile con cassaforma obbligatoria da ordinare separatamente.

LED light source included. Integrated 220-240V ON/OFF and 1-10V/DALI dimmable electrical power. Equipped with one piece of neoprene output cable. IP68 junction system to be ordered separately. Luminaire must be installed with mandatory box for installation, ordered separately.

Mid - Power Led: 12,5W - 1374 lm ≠ FIXT 600 lm - 2700K/CRI>80 - 220-240V / 12,5W - 1429 lm ≠ FIXT 624 lm - 3000K/CRI>80 - 220-240V / 12,5W - 1538 lm ≠ FIXT 672 lm - 4000/CRI>80 - 220-240V

- | | | |
|--|--|--|
| <p>2700K
Non Dimmable</p> <ul style="list-style-type: none"> ○ F023C2CA001 ● F023C2CA006 ● F023C2CA012 ● F023C2CA018 ● F023C2CA030 ● F023C2CA033 <p>1-10V</p> <ul style="list-style-type: none"> ○ F023C2CB001 ● F023C2CB006 ● F023C2CB012 ● F023C2CB018 ● F023C2CB030 ● F023C2CB033 <p>Dali</p> <ul style="list-style-type: none"> ○ F023C2CD001 ● F023C2CD006 ● F023C2CD012 ● F023C2CD018 ● F023C2CD030 ● F023C2CD033 | <p>3000K
Non Dimmable</p> <ul style="list-style-type: none"> ○ F023C3CA001 ● F023C3CA006 ● F023C3CA012 ● F023C3CA018 ● F023C3CA030 ● F023C3CA033 <p>1-10V</p> <ul style="list-style-type: none"> ○ F023C3CB001 ● F023C3CB006 ● F023C3CB012 ● F023C3CB018 ● F023C3CB030 ● F023C3CB033 <p>Dali</p> <ul style="list-style-type: none"> ○ F023C3CD001 ● F023C3CD006 ● F023C3CD012 ● F023C3CD018 ● F023C3CD030 ● F023C3CD033 | <p>4000K
Non Dimmable</p> <ul style="list-style-type: none"> ○ F023C4CA001 ● F023C4CA006 ● F023C4CA012 ● F023C4CA018 ● F023C4CA030 ● F023C4CA033 <p>1-10V</p> <ul style="list-style-type: none"> ○ F023C4CB001 ● F023C4CB006 ● F023C4CB012 ● F023C4CB018 ● F023C4CB030 ● F023C4CB033 <p>Dali</p> <ul style="list-style-type: none"> ○ F023C4CD001 ● F023C4CD006 ● F023C4CD012 ● F023C4CD018 ● F023C4CD030 ● F023C4CD033 |
|--|--|--|

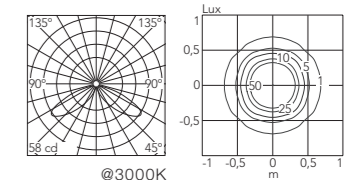

Cassaforma per l'installazione a terra / Box for ground installation.

F023Z030000



Pointbreak Balisage 2 - 105

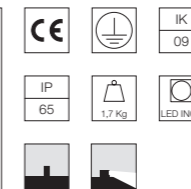
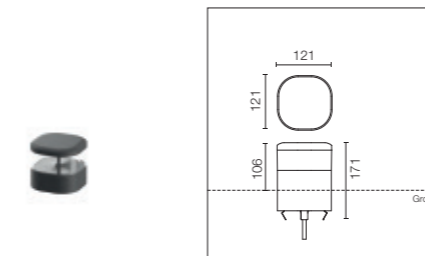

Sorgente luminosa a LED inclusa. Alimentazione elettrica 220-240V ON/OFF e dimmerabile 1-10V o DALI integrata. Dotato di uno spezzone di cavo uscente in neoprene. Sistema di giunzione IP68 da ordinare separatamente. L'apparecchio è installabile con cassaforma obbligatoria da ordinare separatamente.

LED light source included. Integrated 220-240V ON/OFF and 1-10V/DALI dimmable electrical power. Equipped with one piece of neoprene output cable. IP68 junction system to be ordered separately. Luminaire must be installed with mandatory box for installation, ordered separately.

Mid - Power Led: 12,5W - 1374 lm ≠ FIXT 600 lm - 2700K/CRI>80 - 220-240V / 12,5W - 1429 lm ≠ FIXT 624 lm - 3000K/CRI>80 - 220-240V / 12,5W - 1538 lm ≠ FIXT 672 lm - 4000/CRI>80 - 220-240V

- | | | |
|--|--|--|
| <p>2700K
Non Dimmable</p> <ul style="list-style-type: none"> ○ F023C2DA001 ● F023C2DA006 ● F023C2DA012 ● F023C2DA018 ● F023C2DA030 ● F023C2DA033 <p>1-10V</p> <ul style="list-style-type: none"> ○ F023C2DB001 ● F023C2DB006 ● F023C2DB012 ● F023C2DB018 ● F023C2DB030 ● F023C2DB033 <p>Dali</p> <ul style="list-style-type: none"> ○ F023C2DD001 ● F023C2DD006 ● F023C2DD012 ● F023C2DD018 ● F023C2DD030 ● F023C2DD033 | <p>3000K
Non Dimmable</p> <ul style="list-style-type: none"> ○ F023C3DA001 ● F023C3DA006 ● F023C3DA012 ● F023C3DA018 ● F023C3DA030 ● F023C3DA033 <p>1-10V</p> <ul style="list-style-type: none"> ○ F023C3DB001 ● F023C3DB006 ● F023C3DB012 ● F023C3DB018 ● F023C3DB030 ● F023C3DB033 <p>Dali</p> <ul style="list-style-type: none"> ○ F023C3DD001 ● F023C3DD006 ● F023C3DD012 ● F023C3DD018 ● F023C3DD030 ● F023C3DD033 | <p>4000K
Non Dimmable</p> <ul style="list-style-type: none"> ○ F023C4DA001 ● F023C4DA006 ● F023C4DA012 ● F023C4DA018 ● F023C4DA030 ● F023C4DA033 <p>1-10V</p> <ul style="list-style-type: none"> ○ F023C4DB001 ● F023C4DB006 ● F023C4DB012 ● F023C4DB018 ● F023C4DB030 ● F023C4DB033 <p>Dali</p> <ul style="list-style-type: none"> ○ F023C4DD001 ● F023C4DD006 ● F023C4DD012 ● F023C4DD018 ● F023C4DD030 ● F023C4DD033 |
|--|--|--|

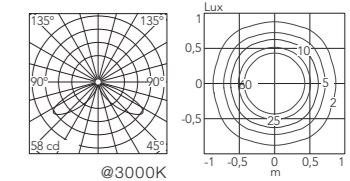

Cassaforma per l'installazione a terra / Box for ground installation.

F023Z040000



* Dati tecnici e fotometrie preliminari. / Preliminary technical specs and photometries.

Pointbreak Wall 0 Up

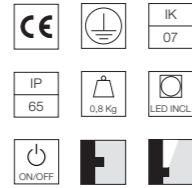
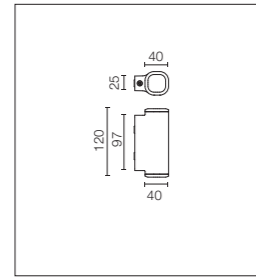

Sorgente luminosa a LED inclusa. Alimentazione elettrica 220-240V ON/OFF integrata. Dotato di passacavo IP65 in gomma e morsetti a 2 poli a connessione rapida.

LED light source included. Integrated 220-240V ON/OFF electrical power. Equipped with IP65 rubber grommet and 2-pole quick-connect terminals.

Power Led: 2,2W - 139 lm ≠ *FIXT 101 lm - 2700K/CRI>80 - 220-240V / 2,2W - 149 lm ≠ *FIXT 108 lm - 3000K/CRI>80 - 220-240V / 2,2W - 154 lm ≠ *FIXT 112 lm - 4000/CRI>80 - 220-240V
*FIXT lm = Spot Optic

Optic Spot

- | | | |
|---|---|---|
| <p>2700K
Non Dimmable</p> <ul style="list-style-type: none"> ○ F023G2EA001 ● F023G2EA006 ● F023G2EA012 ● F023G2EA018 ● F023G2EA030 ● F023G2EA033 | <p>3000K
Non Dimmable</p> <ul style="list-style-type: none"> ○ F023G3EA001 ● F023G3EA006 ● F023G3EA012 ● F023G3EA018 ● F023G3EA030 ● F023G3EA033 | <p>4000K
Non Dimmable</p> <ul style="list-style-type: none"> ○ F023G4EA001 ● F023G4EA006 ● F023G4EA012 ● F023G4EA018 ● F023G4EA030 ● F023G4EA033 |
|---|---|---|

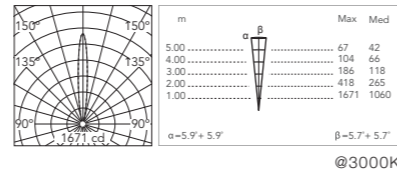

Optic Medium

- | | | |
|---|---|---|
| <p>2700K
Non Dimmable</p> <ul style="list-style-type: none"> ○ F023G2FA001 ● F023G2FA006 ● F023G2FA012 ● F023G2FA018 ● F023G2FA030 ● F023G2FA033 | <p>3000K
Non Dimmable</p> <ul style="list-style-type: none"> ○ F023G3FA001 ● F023G3FA006 ● F023G3FA012 ● F023G3FA018 ● F023G3FA030 ● F023G3FA033 | <p>4000K
Non Dimmable</p> <ul style="list-style-type: none"> ○ F023G4FA001 ● F023G4FA006 ● F023G4FA012 ● F023G4FA018 ● F023G4FA030 ● F023G4FA033 |
|---|---|---|

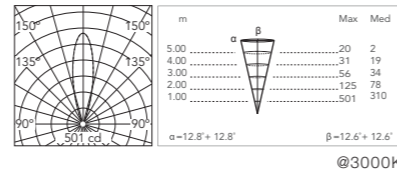

Optic Flood

- | | | |
|---|---|---|
| <p>2700K
Non Dimmable</p> <ul style="list-style-type: none"> ○ F023G2GA001 ● F023G2GA006 ● F023G2GA012 ● F023G2GA018 ● F023G2GA030 ● F023G2GA033 | <p>3000K
Non Dimmable</p> <ul style="list-style-type: none"> ○ F023G3GA001 ● F023G3GA006 ● F023G3GA012 ● F023G3GA018 ● F023G3GA030 ● F023G3GA033 | <p>4000K
Non Dimmable</p> <ul style="list-style-type: none"> ○ F023G4GA001 ● F023G4GA006 ● F023G4GA012 ● F023G4GA018 ● F023G4GA030 ● F023G4GA033 |
|---|---|---|

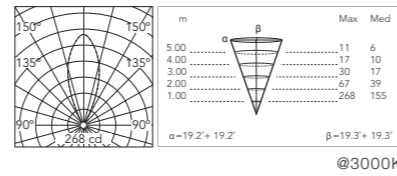

Pointbreak Wall 0 Down

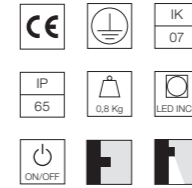
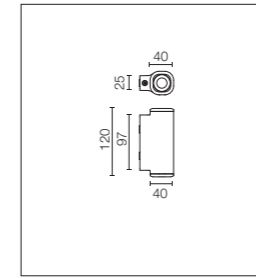

Sorgente luminosa a LED inclusa. Alimentazione elettrica 220-240V ON/OFF integrata. Dotato di passacavo IP65 in gomma e morsetti a 2 poli a connessione rapida.

LED light source included. Integrated 220-240V ON/OFF electrical power. Equipped with IP65 rubber grommet and 2-pole quick-connect terminals.

Power Led: 2,2W - 139 lm ≠ *FIXT 101 lm - 2700K/CRI>80 - 220-240V / 2,2W - 149 lm ≠ *FIXT 108 lm - 3000K/CRI>80 - 220-240V / 2,2W - 154 lm ≠ *FIXT 112 lm - 4000/CRI>80 - 220-240V
*FIXT lm = Spot Optic

Optic Spot

- | | | |
|---|---|---|
| <p>2700K
Non Dimmable</p> <ul style="list-style-type: none"> ○ F023G2JA001 ● F023G2JA006 ● F023G2JA012 ● F023G2JA018 ● F023G2JA030 ● F023G2JA033 | <p>3000K
Non Dimmable</p> <ul style="list-style-type: none"> ○ F023G3JA001 ● F023G3JA006 ● F023G3JA012 ● F023G3JA018 ● F023G3JA030 ● F023G3JA033 | <p>4000K
Non Dimmable</p> <ul style="list-style-type: none"> ○ F023G4JA001 ● F023G4JA006 ● F023G4JA012 ● F023G4JA018 ● F023G4JA030 ● F023G4JA033 |
|---|---|---|

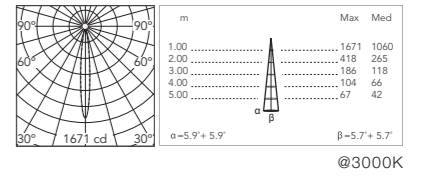

Optic Medium

- | | | |
|---|---|---|
| <p>2700K
Non Dimmable</p> <ul style="list-style-type: none"> ○ F023G2KA001 ● F023G2KA006 ● F023G2KA012 ● F023G2KA018 ● F023G2KA030 ● F023G2KA033 | <p>3000K
Non Dimmable</p> <ul style="list-style-type: none"> ○ F023G3KA001 ● F023G3KA006 ● F023G3KA012 ● F023G3KA018 ● F023G3KA030 ● F023G3KA033 | <p>4000K
Non Dimmable</p> <ul style="list-style-type: none"> ○ F023G4KA001 ● F023G4KA006 ● F023G4KA012 ● F023G4KA018 ● F023G4KA030 ● F023G4KA033 |
|---|---|---|

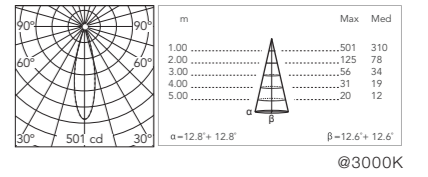

Optic Flood

- | | | |
|---|---|---|
| <p>2700K
Non Dimmable</p> <ul style="list-style-type: none"> ○ F023G2LA001 ● F023G2LA006 ● F023G2LA012 ● F023G2LA018 ● F023G2LA030 ● F023G2LA033 | <p>3000K
Non Dimmable</p> <ul style="list-style-type: none"> ○ F023G3LA001 ● F023G3LA006 ● F023G3LA012 ● F023G3LA018 ● F023G3LA030 ● F023G3LA033 | <p>4000K
Non Dimmable</p> <ul style="list-style-type: none"> ○ F023G4LA001 ● F023G4LA006 ● F023G4LA012 ● F023G4LA018 ● F023G4LA030 ● F023G4LA033 |
|---|---|---|

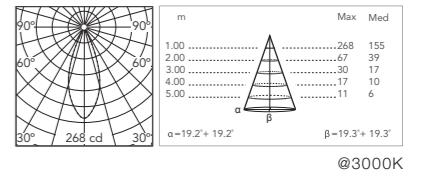

Pointbreak Wall 0 Up&Down

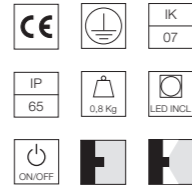
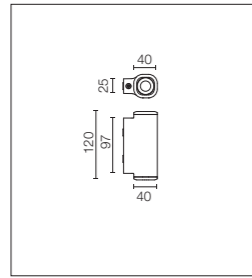

Sorgente luminosa a LED inclusa. Alimentazione elettrica 220-240V ON/OFF integrata. Dotato di passacavo IP65 in gomma e morsetti a 2 poli a connessione rapida.

LED light source included. Integrated 220-240V ON/OFF electrical power. Equipped with IP65 rubber grommet and 2-pole quick-connect terminals.

Power Led: 3,4W - 2x139 lm ≠ *FIXT 2x101 lm - 2700K/CRI>80 - 220-240V / 3,4W - 2x149 lm ≠ *FIXT 2x108 lm - 3000K/CRI>80 - 220-240V / 3,4W - 2x154 lm ≠ *FIXT 2x112 lm - 4000/CRI>80 - 220-240V
*FIXT lm = Spot Optic

Optic Spot

- | | | |
|--|--|--|
| 2700K
Non Dimmable
<ul style="list-style-type: none"> ○ F023G25A001 ● F023G25A006 ● F023G25A012 ● F023G25A018 ● F023G25A030 ● F023G25A033 | 3000K
Non Dimmable
<ul style="list-style-type: none"> ○ F023G35A001 ● F023G35A006 ● F023G35A012 ● F023G35A018 ● F023G35A030 ● F023G35A033 | 4000K
Non Dimmable
<ul style="list-style-type: none"> ○ F023G45A001 ● F023G45A006 ● F023G45A012 ● F023G45A018 ● F023G45A030 ● F023G45A033 |
|--|--|--|

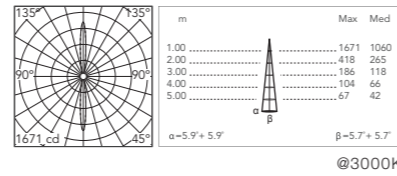

Optic Medium

- | | | |
|--|--|--|
| 2700K
Non Dimmable
<ul style="list-style-type: none"> ○ F023G26A001 ● F023G26A006 ● F023G26A012 ● F023G26A018 ● F023G26A030 ● F023G26A033 | 3000K
Non Dimmable
<ul style="list-style-type: none"> ○ F023G36A001 ● F023G36A006 ● F023G36A012 ● F023G36A018 ● F023G36A030 ● F023G36A033 | 4000K
Non Dimmable
<ul style="list-style-type: none"> ○ F023G46A001 ● F023G46A006 ● F023G46A012 ● F023G46A018 ● F023G46A030 ● F023G46A033 |
|--|--|--|

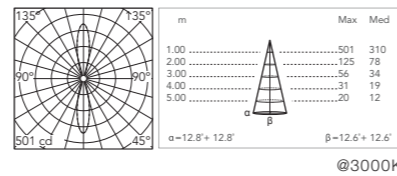

Optic Flood

- | | | |
|--|--|--|
| 2700K
Non Dimmable
<ul style="list-style-type: none"> ○ F023G27A001 ● F023G27A006 ● F023G27A012 ● F023G27A018 ● F023G27A030 ● F023G27A033 | 3000K
Non Dimmable
<ul style="list-style-type: none"> ○ F023G37A001 ● F023G37A006 ● F023G37A012 ● F023G37A018 ● F023G37A030 ● F023G37A033 | 4000K
Non Dimmable
<ul style="list-style-type: none"> ○ F023G47A001 ● F023G47A006 ● F023G47A012 ● F023G47A018 ● F023G47A030 ● F023G47A033 |
|--|--|--|

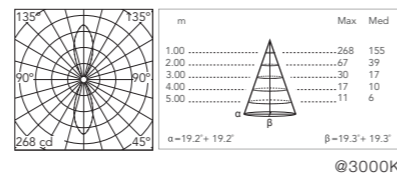

* Dati tecnici preliminari. / Preliminary technical specs.

Pointbreak Wall 1 Down

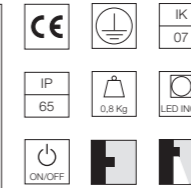
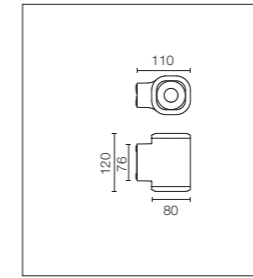

Sorgente luminosa a LED inclusa. Alimentazione elettrica 220-240V ON/OFF integrata. Dotato di doppio passacavo per collegamento entra-esce. A richiesta versione monoemissione verso l'alto/Up.

LED light source included. Integrated 220-240V ON/OFF electrical power. Equipped with double cable gland for inlet and outlet connection. Upwards, single emission version, available upon request.

Optic Spot

Power Led: 6,5W - 543 lm ≠ FIXT 357 lm - 2700K/CRI>80 - 220-240V / 6,5W - 570 lm ≠ FIXT 375 lm - 3000K/CRI>80 - 220-240V / 6,5W - 597 lm ≠ FIXT 393 lm - 4000/CRI>80 - 220-240V

- | | | |
|--|--|--|
| 2700K
Non Dimmable
<ul style="list-style-type: none"> ○ F023H21A001 ● F023H21A006 ● F023H21A012 ● F023H21A018 ● F023H21A030 ● F023H21A033 | 3000K
Non Dimmable
<ul style="list-style-type: none"> ○ F023H31A001 ● F023H31A006 ● F023H31A012 ● F023H31A018 ● F023H31A030 ● F023H31A033 | 4000K
Non Dimmable
<ul style="list-style-type: none"> ○ F023H41A001 ● F023H41A006 ● F023H41A012 ● F023H41A018 ● F023H41A030 ● F023H41A033 |
|--|--|--|

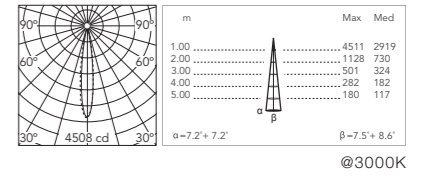

Optic Medium

Power LED: 6,5W - 543 lm ≠ FIXT 372 lm - 2700K/CRI>80 - 220-240V / 6,5W - 570 lm ≠ FIXT 391 lm - 3000K/CRI>80 - 220-240V / 6,5W - 597 lm ≠ FIXT 410 lm - 4000/CRI>80 - 220-240V

- | | | |
|--|--|--|
| 2700K
Non Dimmable
<ul style="list-style-type: none"> ○ F023H22A001 ● F023H22A006 ● F023H22A012 ● F023H22A018 ● F023H22A030 ● F023H22A033 | 3000K
Non Dimmable
<ul style="list-style-type: none"> ○ F023H32A001 ● F023H32A006 ● F023H32A012 ● F023H32A018 ● F023H32A030 ● F023H32A033 | 4000K
Non Dimmable
<ul style="list-style-type: none"> ○ F023H42A001 ● F023H42A006 ● F023H42A012 ● F023H42A018 ● F023H42A030 ● F023H42A033 |
|--|--|--|

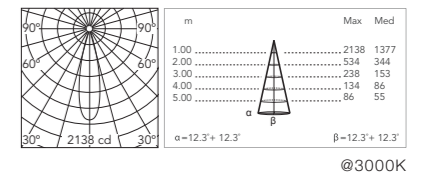

Optic Flood

Power LED: 6,5W - 543 lm ≠ FIXT 364 lm - 2700K/CRI>80 - 220-240V / 6,5W - 570 lm ≠ FIXT 382 lm - 3000K/CRI>80 - 220-240V / 6,5W - 597 lm ≠ FIXT 400 lm - 4000/CRI>80 - 220-240V

- | | | |
|--|--|--|
| 2700K
Non Dimmable
<ul style="list-style-type: none"> ○ F023H23A001 ● F023H23A006 ● F023H23A012 ● F023H23A018 ● F023H23A030 ● F023H23A033 | 3000K
Non Dimmable
<ul style="list-style-type: none"> ○ F023H33A001 ● F023H33A006 ● F023H33A012 ● F023H33A018 ● F023H33A030 ● F023H33A033 | 4000K
Non Dimmable
<ul style="list-style-type: none"> ○ F023H43A001 ● F023H43A006 ● F023H43A012 ● F023H43A018 ● F023H43A030 ● F023H43A033 |
|--|--|--|

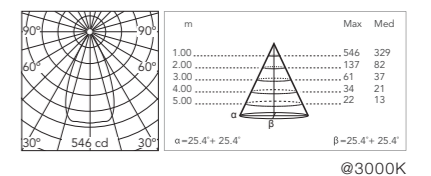

* Dati tecnici preliminari. / Preliminary technical specs.

Pointbreak Wall 1 Up&Down

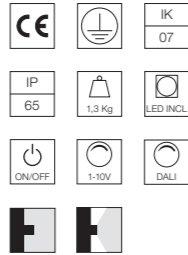
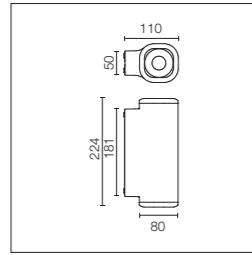

Sorgente luminosa a LED inclusa. Alimentazione elettrica 220-240V ON/OFF e dimmerabile 1-10V o DALI integrata. Dotato di doppio passacavo per collegamento entra-esce. A richiesta versione monoemissione verso l'alto o monoemissione verso il basso.

LED light source included. Integrated 220-240V ON/OFF and 1-10V/DALI dimmable electrical power. Equipped with double cable gland for inlet and outlet connection. Upon request: Single upwards emission or single downwards emission.

Optic Spot

Power Led: 12W - 2x543 lm ≠ FIXT 2x357 lm - 2700K/CRI>80 - 220-240V / 12W - 2x570 lm ≠ FIXT 2x375 lm - 3000K/CRI>80 - 220-240V / 12W - 2x597 lm ≠ FIXT 2x393 lm - 4000K/CRI>80 - 220-240V

2700K

- Non Dimmable
- F023H25A001
 - F023H25A006
 - F023H25A012
 - F023H25A018
 - F023H25A030
 - F023H25A033
- 1-10V
- F023H25B001
 - F023H25B006
 - F023H25B012
 - F023H25B018
 - F023H25B030
 - F023H25B033
- Dali
- F023H25D001
 - F023H25D006
 - F023H25D012
 - F023H25D018
 - F023H25D030
 - F023H25D033

3000K

- Non Dimmable
- F023H35A001
 - F023H35A006
 - F023H35A012
 - F023H35A018
 - F023H35A030
 - F023H35A033
- 1-10V
- F023H35B001
 - F023H35B006
 - F023H35B012
 - F023H35B018
 - F023H35B030
 - F023H35B033
- Dali
- F023H35D001
 - F023H35D006
 - F023H35D012
 - F023H35D018
 - F023H35D030
 - F023H35D033

4000K

- Non Dimmable
- F023H45A001
 - F023H45A006
 - F023H45A012
 - F023H45A018
 - F023H45A030
 - F023H45A033
- 1-10V
- F023H45B001
 - F023H45B006
 - F023H45B012
 - F023H45B018
 - F023H45B030
 - F023H45B033
- Dali
- F023H45D001
 - F023H45D006
 - F023H45D012
 - F023H45D018
 - F023H45D030
 - F023H45D033

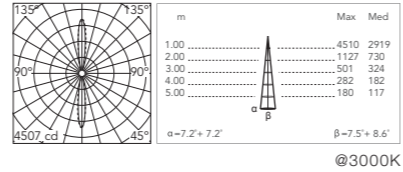

Optic Medium

Power Led: 12W - 2x543 lm ≠ FIXT 2x372 lm - 2700K/CRI>80 - 220-240V / 12W - 2x570 lm ≠ FIXT 2x391 lm - 3000K/CRI>80 - 220-240V / 12W - 2x597 lm ≠ FIXT 2x410 lm - 4000K/CRI>80 - 220-240V

2700K

- Non Dimmable
- F023H26A001
 - F023H26A006
 - F023H26A012
 - F023H26A018
 - F023H26A030
 - F023H26A033
- 1-10V
- F023H26B001
 - F023H26B006
 - F023H26B012
 - F023H26B018
 - F023H26B030
 - F023H26B033
- Dali
- F023H26D001
 - F023H26D006
 - F023H26D012
 - F023H26D018
 - F023H26D030
 - F023H26D033

3000K

- Non Dimmable
- F023H36A001
 - F023H36A006
 - F023H36A012
 - F023H36A018
 - F023H36A030
 - F023H36A033
- 1-10V
- F023H36B001
 - F023H36B006
 - F023H36B012
 - F023H36B018
 - F023H36B030
 - F023H36B033
- Dali
- F023H36D001
 - F023H36D006
 - F023H36D012
 - F023H36D018
 - F023H36D030
 - F023H36D033

4000K

- Non Dimmable
- F023H46A001
 - F023H46A006
 - F023H46A012
 - F023H46A018
 - F023H46A030
 - F023H46A033
- 1-10V
- F023H46B001
 - F023H46B006
 - F023H46B012
 - F023H46B018
 - F023H46B030
 - F023H46B033
- Dali
- F023H46D001
 - F023H46D006
 - F023H46D012
 - F023H46D018
 - F023H46D030
 - F023H46D033

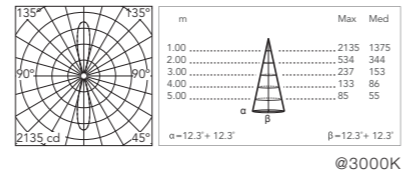

Optic Flood

Power Led: 12W - 2x543 lm ≠ FIXT 2x364 lm - 2700K/CRI>80 - 220-240V / 12W - 2x570 lm ≠ FIXT 2x382 lm - 3000K/CRI>80 - 220-240V / 12W - 2x597 lm ≠ FIXT 2x400 lm - 4000K/CRI>80 - 220-240V

2700K

- Non Dimmable
- F023H27A001
 - F023H27A006
 - F023H27A012
 - F023H27A018
 - F023H27A030
 - F023H27A033
- 1-10V
- F023H27B001
 - F023H27B006
 - F023H27B012
 - F023H27B018
 - F023H27B030
 - F023H27B033
- Dali
- F023H27D001
 - F023H27D006
 - F023H27D012
 - F023H27D018
 - F023H27D030
 - F023H27D033

3000K

- Non Dimmable
- F023H37A001
 - F023H37A006
 - F023H37A012
 - F023H37A018
 - F023H37A030
 - F023H37A033
- 1-10V
- F023H37B001
 - F023H37B006
 - F023H37B012
 - F023H37B018
 - F023H37B030
 - F023H37B033
- Dali
- F023H37D001
 - F023H37D006
 - F023H37D012
 - F023H37D018
 - F023H37D030
 - F023H37D033

4000K

- Non Dimmable
- F023H47A001
 - F023H47A006
 - F023H47A012
 - F023H47A018
 - F023H47A030
 - F023H47A033
- 1-10V
- F023H47B001
 - F023H47B006
 - F023H47B012
 - F023H47B018
 - F023H47B030
 - F023H47B033
- Dali
- F023H47D001
 - F023H47D006
 - F023H47D012
 - F023H47D018
 - F023H47D030
 - F023H47D033

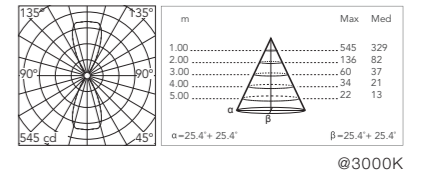

Pointbreak Wall 2 Down

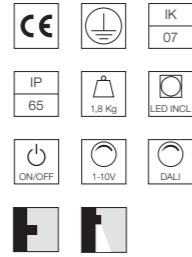
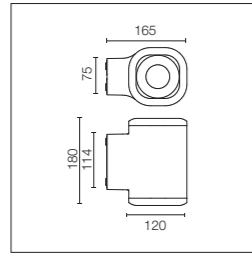

Sorgente luminosa a LED inclusa. Alimentazione elettrica 220-240V ON/OFF e dimmerabile 1-10V o DALI integrata. Dotato di doppio passacavo per collegamento entra-esce. A richiesta versione monoemissione verso l'alto/Up.

LED light source included. Integrated 220-240V ON/OFF and 1-10V/DALI dimmable electrical power. Equipped with double cable gland for inlet and outlet connection. Upwards, single emission version, available upon request.

Optic Spot

Power Led: 17,5W - 1890 lm ≠ FIXT 1316 lm - 2700K/CRI>80 - 220-240V / 17,5W - 1960 lm ≠ FIXT 1365 lm - 3000K/CRI>80 - 220-240V / 17,5W - 2030 lm ≠ FIXT 1414 lm - 4000/CRI>80 - 220-240V

2700K

- Non Dimmable
- F023J21A001
- F023J21A006
- F023J21A012
- F023J21A018
- F023J21A030
- F023J21A033
- 1-10V
- F023J21B001
- F023J21B006
- F023J21B012
- F023J21B018
- F023J21B030
- F023J21B033
- Dali
- F023J21D001
- F023J21D006
- F023J21D012
- F023J21D018
- F023J21D030
- F023J21D033

3000K

- Non Dimmable
- F023J31A001
- F023J31A006
- F023J31A012
- F023J31A018
- F023J31A030
- F023J31A033
- 1-10V
- F023J31B001
- F023J31B006
- F023J31B012
- F023J31B018
- F023J31B030
- F023J31B033
- Dali
- F023J31D001
- F023J31D006
- F023J31D012
- F023J31D018
- F023J31D030
- F023J31D033

4000K

- Non Dimmable
- F023J41A001
- F023J41A006
- F023J41A012
- F023J41A018
- F023J41A030
- F023J41A033
- 1-10V
- F023J41B001
- F023J41B006
- F023J41B012
- F023J41B018
- F023J41B030
- F023J41B033
- Dali
- F023J41D001
- F023J41D006
- F023J41D012
- F023J41D018
- F023J41D030
- F023J41D033

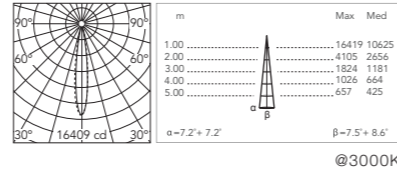

Optic Flood

Power Led: 17,5W - 1890 lm ≠ FIXT 1342 lm - 2700K/CRI>80 - 220-240V / 17,5W - 1960 lm ≠ FIXT 1392 lm - 3000K/CRI>80 - 220-240V / 17,5W - 2030 lm ≠ FIXT 1442 lm - 4000/CRI>80 - 220-240V

2700K

- Non Dimmable
- F023J23A001
- F023J23A006
- F023J23A012
- F023J23A018
- F023J23A030
- F023J23A033
- 1-10V
- F023J23B001
- F023J23B006
- F023J23B012
- F023J23B018
- F023J23B030
- F023J23B033
- Dali
- F023J23D001
- F023J23D006
- F023J23D012
- F023J23D018
- F023J23D030
- F023J23D033

3000K

- Non Dimmable
- F023J33A001
- F023J33A006
- F023J33A012
- F023J33A018
- F023J33A030
- F023J33A033
- 1-10V
- F023J33B001
- F023J33B006
- F023J33B012
- F023J33B018
- F023J33B030
- F023J33B033
- Dali
- F023J33D001
- F023J33D006
- F023J33D012
- F023J33D018
- F023J33D030
- F023J33D033

4000K

- Non Dimmable
- F023J43A001
- F023J43A006
- F023J43A012
- F023J43A018
- F023J43A030
- F023J43A033
- 1-10V
- F023J43B001
- F023J43B006
- F023J43B012
- F023J43B018
- F023J43B030
- F023J43B033
- Dali
- F023J43D001
- F023J43D006
- F023J43D012
- F023J43D018
- F023J43D030
- F023J43D033

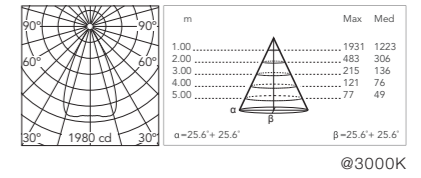

Optic Medium

Power Led: 17,5W - 1890 lm ≠ FIXT 1370 lm - 2700K/CRI>80 - 220-240V / 17,5W - 1960 lm ≠ FIXT 1420lm - 3000K/CRI>80 - 220-240V / 17,5W - 2030 lm ≠ FIXT 1471 lm - 4000/CRI>80 - 220-240V

2700K

- Non Dimmable
- F023J22A001
- F023J22A006
- F023J22A012
- F023J22A018
- F023J22A030
- F023J22A033
- 1-10V
- F023J22B001
- F023J22B006
- F023J22B012
- F023J22B018
- F023J22B030
- F023J22B033
- Dali
- F023J22D001
- F023J22D006
- F023J22D012
- F023J22D018
- F023J22D030
- F023J22D033

3000K

- Non Dimmable
- F023J32A001
- F023J32A006
- F023J32A012
- F023J32A018
- F023J32A030
- F023J32A033
- 1-10V
- F023J32B001
- F023J32B006
- F023J32B012
- F023J32B018
- F023J32B030
- F023J32B033
- Dali
- F023J32D001
- F023J32D006
- F023J32D012
- F023J32D018
- F023J32D030
- F023J32D033

4000K

- Non Dimmable
- F023J42A001
- F023J42A006
- F023J42A012
- F023J42A018
- F023J42A030
- F023J42A033
- 1-10V
- F023J42B001
- F023J42B006
- F023J42B012
- F023J42B018
- F023J42B030
- F023J42B033
- Dali
- F023J42D001
- F023J42D006
- F023J42D012
- F023J42D018
- F023J42D030
- F023J42D033

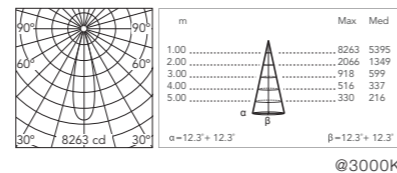

* Dati tecnici preliminari. / Preliminary technical specs.

* Dati tecnici preliminari. / Preliminary technical specs.

Pointbreak Wall 2 Up&Down

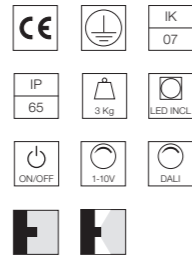
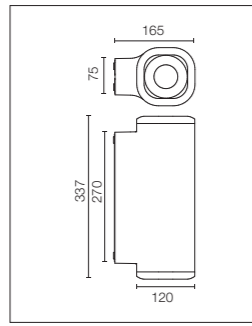

Sorgente luminosa a LED inclusa. Alimentazione elettrica 220-240V ON/OFF e dimmerabile 1-10V o DALI integrata. Dotato di doppio passacavo per collegamento entra-esce. A richiesta versione monoemissione verso l'alto o monoemissione verso il basso.

LED light source included. Integrated 220-240V ON/OFF and 1-10V/DALI dimmable electrical power. Equipped with double cable gland for inlet and outlet connection. Upon request: Single upwards emission or single downwards emission.

Optic Spot

Power Led: 32W - 2x1890 lm ≠ FIXT 2x1316 lm - 2700K/CRI>80 - 220-240V / 32W - 2x1960 lm ≠ FIXT 2x1365 lm - 3000K/CRI>80 - 220-240V / 32W - 2x2030 lm ≠ FIXT 2x1414 lm - 4000/CRI>80 - 220-240V

- | | | |
|--|--|--|
| <p>2700K
Non Dimmable</p> <ul style="list-style-type: none"> ○ F023J25A001 ● F023J25A006 ● F023J25A012 ● F023J25A018 ● F023J25A030 ● F023J25A033 <p>1-10V</p> <ul style="list-style-type: none"> ○ F023J25B001 ● F023J25B006 ● F023J25B012 ● F023J25B018 ● F023J25B030 ● F023J25B033 <p>Dali</p> <ul style="list-style-type: none"> ○ F023J25D001 ● F023J25D006 ● F023J25D012 ● F023J25D018 ● F023J25D030 ● F023J25D033 | <p>3000K
Non Dimmable</p> <ul style="list-style-type: none"> ○ F023J35A001 ● F023J35A006 ● F023J35A012 ● F023J35A018 ● F023J35A030 ● F023J35A033 <p>1-10V</p> <ul style="list-style-type: none"> ○ F023J35B001 ● F023J35B006 ● F023J35B012 ● F023J35B018 ● F023J35B030 ● F023J35B033 <p>Dali</p> <ul style="list-style-type: none"> ○ F023J35D001 ● F023J35D006 ● F023J35D012 ● F023J35D018 ● F023J35D030 ● F023J35D033 | <p>4000K
Non Dimmable</p> <ul style="list-style-type: none"> ○ F023J45A001 ● F023J45A006 ● F023J45A012 ● F023J45A018 ● F023J45A030 ● F023J45A033 <p>1-10V</p> <ul style="list-style-type: none"> ○ F023J45B001 ● F023J45B006 ● F023J45B012 ● F023J45B018 ● F023J45B030 ● F023J45B033 <p>Dali</p> <ul style="list-style-type: none"> ○ F023J45D001 ● F023J45D006 ● F023J45D012 ● F023J45D018 ● F023J45D030 ● F023J45D033 |
|--|--|--|

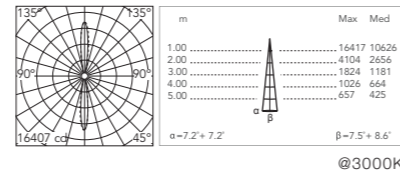

Optic Medium

Power Led: 32W - 2x1890 lm ≠ FIXT 2x1370 lm - 2700K/CRI>80 - 220-240V / 32W - 2x1960 lm ≠ FIXT 2x1420lm - 3000K/CRI>80 - 220-240V / 32W - 2x2030 lm ≠ FIXT 2x1471 lm - 4000/CRI>80 - 220-240V

- | | | |
|--|--|--|
| <p>2700K
Non Dimmable</p> <ul style="list-style-type: none"> ○ F023J26A001 ● F023J26A006 ● F023J26A012 ● F023J26A018 ● F023J26A030 ● F023J26A033 <p>1-10V</p> <ul style="list-style-type: none"> ○ F023J26B001 ● F023J26B006 ● F023J26B012 ● F023J26B018 ● F023J26B030 ● F023J26B033 <p>Dali</p> <ul style="list-style-type: none"> ○ F023J26D001 ● F023J26D006 ● F023J26D012 ● F023J26D018 ● F023J26D030 ● F023J26D033 | <p>3000K
Non Dimmable</p> <ul style="list-style-type: none"> ○ F023J36A001 ● F023J36A006 ● F023J36A012 ● F023J36A018 ● F023J36A030 ● F023J36A033 <p>1-10V</p> <ul style="list-style-type: none"> ○ F023J36B001 ● F023J36B006 ● F023J36B012 ● F023J36B018 ● F023J36B030 ● F023J36B033 <p>Dali</p> <ul style="list-style-type: none"> ○ F023J36D001 ● F023J36D006 ● F023J36D012 ● F023J36D018 ● F023J36D030 ● F023J36D033 | <p>4000K
Non Dimmable</p> <ul style="list-style-type: none"> ○ F023J46A001 ● F023J46A006 ● F023J46A012 ● F023J46A018 ● F023J46A030 ● F023J46A033 <p>1-10V</p> <ul style="list-style-type: none"> ○ F023J46B001 ● F023J46B006 ● F023J46B012 ● F023J46B018 ● F023J46B030 ● F023J46B033 <p>Dali</p> <ul style="list-style-type: none"> ○ F023J46D001 ● F023J46D006 ● F023J46D012 ● F023J46D018 ● F023J46D030 ● F023J46D033 |
|--|--|--|

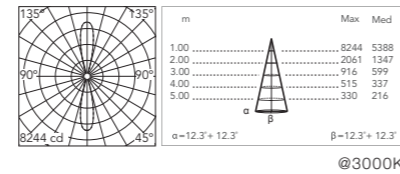

Optic Flood

Power Led: 32W - 2x1890 lm ≠ FIXT 2x1342 lm - 2700K/CRI>80 - 220-240V / 32W - 2x1960 lm ≠ FIXT 2x1392 lm - 3000K/CRI>80 - 220-240V / 32W - 2x2030 lm ≠ FIXT 2x1442 lm - 4000/CRI>80 - 220-240V

- | | | |
|--|--|--|
| <p>2700K
Non Dimmable</p> <ul style="list-style-type: none"> ○ F023J27A001 ● F023J27A006 ● F023J27A012 ● F023J27A018 ● F023J27A030 ● F023J27A033 <p>1-10V</p> <ul style="list-style-type: none"> ○ F023J27B001 ● F023J27B006 ● F023J27B012 ● F023J27B018 ● F023J27B030 ● F023J27B033 <p>Dali</p> <ul style="list-style-type: none"> ○ F023J27D001 ● F023J27D006 ● F023J27D012 ● F023J27D018 ● F023J27D030 ● F023J27D033 | <p>3000K
Non Dimmable</p> <ul style="list-style-type: none"> ○ F023J37A001 ● F023J37A006 ● F023J37A012 ● F023J37A018 ● F023J37A030 ● F023J37A033 <p>1-10V</p> <ul style="list-style-type: none"> ○ F023J37B001 ● F023J37B006 ● F023J37B012 ● F023J37B018 ● F023J37B030 ● F023J37B033 <p>Dali</p> <ul style="list-style-type: none"> ○ F023J37D001 ● F023J37D006 ● F023J37D012 ● F023J37D018 ● F023J37D030 ● F023J37D033 | <p>4000K
Non Dimmable</p> <ul style="list-style-type: none"> ○ F023J47A001 ● F023J47A006 ● F023J47A012 ● F023J47A018 ● F023J47A030 ● F023J47A033 <p>1-10V</p> <ul style="list-style-type: none"> ○ F023J47B001 ● F023J47B006 ● F023J47B012 ● F023J47B018 ● F023J47B030 ● F023J47B033 <p>Dali</p> <ul style="list-style-type: none"> ○ F023J47D001 ● F023J47D006 ● F023J47D012 ● F023J47D018 ● F023J47D030 ● F023J47D033 |
|--|--|--|

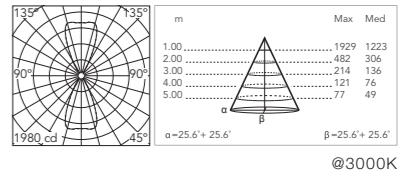

Pointbreak Ceiling 0

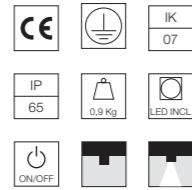
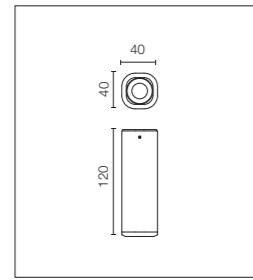

Sorgente luminosa a LED inclusa. Alimentazione elettrica 220-240V ON/OFF integrata. Dotato di passacavo IP65 in gomma e morsetti a 2 poli a connessione rapida.

LED light source included. Integrated 220-240V ON/OFF electrical power. Equipped with IP65 rubber grommet and 2-pole quick-connect terminals.

Power LED: 2,2W - 139 lm ≠ *FIXT 101 lm - 2700K/CRI>80 - 220-240V / 2,2W - 149 lm ≠ *FIXT 108 lm - 3000K/CRI>80 - 220-240V / 2,2W - 154 lm ≠ *FIXT 112 lm - 4000/CRI>80 - 220-240V
*FIXT lm = Spot Optic

Optic Spot

2700K

Non Dimmable

- F023K21A001
- F023K21A006
- F023K21A012
- F023K21A018
- F023K21A030
- F023K21A033

3000K

Non Dimmable

- F023K31A001
- F023K31A006
- F023K31A012
- F023K31A018
- F023K31A030
- F023K31A033

4000K

Non Dimmable

- F023K41A001
- F023K41A006
- F023K41A012
- F023K41A018
- F023K41A030
- F023K41A033

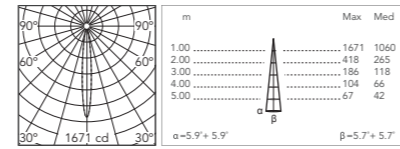

@3000K

Optic Medium

2700K

Non Dimmable

- F023K22A001
- F023K22A006
- F023K22A012
- F023K22A018
- F023K22A030
- F023K22A033

3000K

Non Dimmable

- F023K32A001
- F023K32A006
- F023K32A012
- F023K32A018
- F023K32A030
- F023K32A033

4000K

Non Dimmable

- F023K42A001
- F023K42A006
- F023K42A012
- F023K42A018
- F023K42A030
- F023K42A033

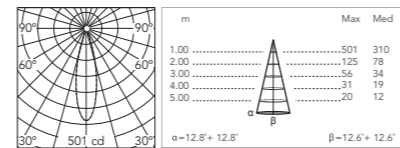

@3000K

Optic Flood

2700K

Non Dimmable

- F023K23A001
- F023K23A006
- F023K23A012
- F023K23A018
- F023K23A030
- F023K23A033

3000K

Non Dimmable

- F023K33A001
- F023K33A006
- F023K33A012
- F023K33A018
- F023K33A030
- F023K33A033

4000K

Non Dimmable

- F023K43A001
- F023K43A006
- F023K43A012
- F023K43A018
- F023K43A030
- F023K43A033

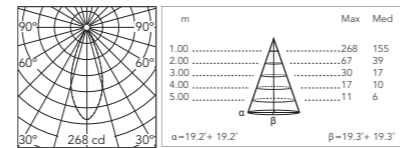

@3000K

Pointbreak Ceiling 1

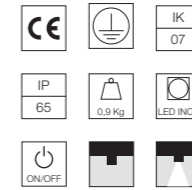
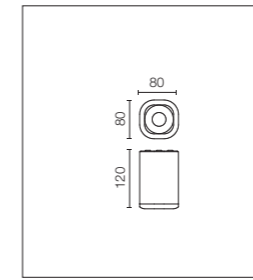

Sorgente luminosa a LED inclusa. Alimentazione elettrica 220-240V ON/OFF integrata. Dotato di doppio passacavo per collegamento entra-esce.

LED light source included. Integrated 220-240V ON/OFF electrical power. Equipped with double cable gland for inlet and outlet connection.

Optic Spot

Power LED: 6,5W - 543 lm ≠ FIXT 357 lm - 2700K/CRI>80 - 220-240V / 6,5W - 570 lm ≠ FIXT 375 lm - 3000K/CRI>80 - 220-240V / 6,5W - 597 lm ≠ FIXT 393 lm - 4000/CRI>80 - 220-240V

2700K

Non Dimmable

- F023L21A001
- F023L21A006
- F023L21A012
- F023L21A018
- F023L21A030
- F023L21A033

3000K

Non Dimmable

- F023L31A001
- F023L31A006
- F023L31A012
- F023L31A018
- F023L31A030
- F023L31A033

4000K

Non Dimmable

- F023L41A001
- F023L41A006
- F023L41A012
- F023L41A018
- F023L41A030
- F023L41A033

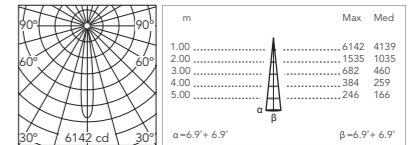

@3000K

Optic Medium

Power LED: 6,5W - 543 lm ≠ FIXT 372 lm - 2700K/CRI>80 - 220-240V / 6,5W - 570 lm ≠ FIXT 391 lm - 3000K/CRI>80 - 220-240V / 6,5W - 597 lm ≠ FIXT 410 lm - 4000/CRI>80 - 220-240V

2700K

Non Dimmable

- F023L22A001
- F023L22A006
- F023L22A012
- F023L22A018
- F023L22A030
- F023L22A033

3000K

Non Dimmable

- F023L32A001
- F023L32A006
- F023L32A012
- F023L32A018
- F023L32A030
- F023L32A033

4000K

Non Dimmable

- F023L42A001
- F023L42A006
- F023L42A012
- F023L42A018
- F023L42A030
- F023L42A033

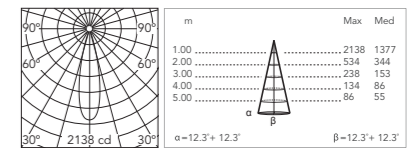

@3000K

Optic Flood

Power LED: 6,5W - 543 lm ≠ FIXT 364 lm - 2700K/CRI>80 - 220-240V / 6,5W - 570 lm ≠ FIXT 382 lm - 3000K/CRI>80 - 220-240V / 6,5W - 597 lm ≠ FIXT 400 lm - 4000/CRI>80 - 220-240V

2700K

Non Dimmable

- F023L23A001
- F023L23A006
- F023L23A012
- F023L23A018
- F023L23A030
- F023L23A033

3000K

Non Dimmable

- F023L33A001
- F023L33A006
- F023L33A012
- F023L33A018
- F023L33A030
- F023L33A033

4000K

Non Dimmable

- F023L43A001
- F023L43A006
- F023L43A012
- F023L43A018
- F023L43A030
- F023L43A033

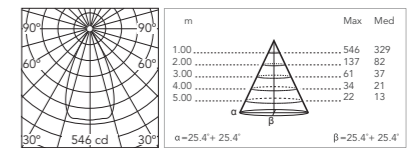

@3000K

Pointbreak Ceiling 2

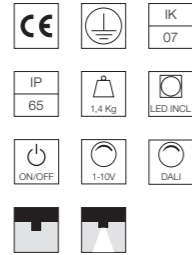
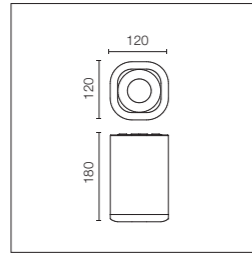

Sorgente luminosa a LED inclusa. Alimentazione elettrica 220-240V ON/OFF e dimmerabile 1-10V o DALI integrata. Dotato di doppio passacavo per collegamento entra-esce.

LED light source included. Integrated 220-240V ON/OFF and 1-10V/DALI dimmable electrical power. Equipped with double cable gland for inlet and outlet connection.

Optic Spot

Power Led: 17,5W - 1890 lm ≠ FIXT 1316 lm - 2700K/CRI>80 - 220-240V / 17,5W - 1960 lm ≠ FIXT 1365 lm - 3000K/CRI>80 - 220-240V / 17,5W - 2030 lm ≠ FIXT 1414 lm - 4000/CRI>80 - 220-240V

- | | | |
|--|--|--|
| <p>2700K
Non Dimmable</p> <ul style="list-style-type: none"> ○ F023M21A001 ● F023M21A006 ● F023M21A012 ● F023M21A018 ● F023M21A030 ● F023M21A033 <p>1-10V</p> <ul style="list-style-type: none"> ○ F023M21B001 ● F023M21B006 ● F023M21B012 ● F023M21B018 ● F023M21B030 ● F023M21B033 <p>Dali</p> <ul style="list-style-type: none"> ○ F023M21D001 ● F023M21D006 ● F023M21D012 ● F023M21D018 ● F023M21D030 ● F023M21D033 | <p>3000K
Non Dimmable</p> <ul style="list-style-type: none"> ○ F023M31A001 ● F023M31A006 ● F023M31A012 ● F023M31A018 ● F023M31A030 ● F023M31A033 <p>1-10V</p> <ul style="list-style-type: none"> ○ F023M31B001 ● F023M31B006 ● F023M31B012 ● F023M31B018 ● F023M31B030 ● F023M31B033 <p>Dali</p> <ul style="list-style-type: none"> ○ F023M31D001 ● F023M31D006 ● F023M31D012 ● F023M31D018 ● F023M31D030 ● F023M31D033 | <p>4000K
Non Dimmable</p> <ul style="list-style-type: none"> ○ F023M41A001 ● F023M41A006 ● F023M41A012 ● F023M41A018 ● F023M41A030 ● F023M41A033 <p>1-10V</p> <ul style="list-style-type: none"> ○ F023M41B001 ● F023M41B006 ● F023M41B012 ● F023M41B018 ● F023M41B030 ● F023M41B033 <p>Dali</p> <ul style="list-style-type: none"> ○ F023M41D001 ● F023M41D006 ● F023M41D012 ● F023M41D018 ● F023M41D030 ● F023M41D033 |
|--|--|--|

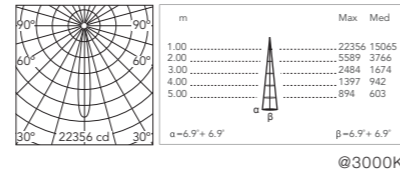

Optic Medium

Power Led: 17,5W - 1890 lm ≠ FIXT 1370 lm - 2700K/CRI>80 - 220-240V / 17,5W - 1960 lm ≠ FIXT 1420lm - 3000K/CRI>80 - 220-240V / 17,5W - 2030 lm ≠ FIXT 1471 lm - 4000/CRI>80 - 220-240V

- | | | |
|--|--|--|
| <p>2700K
Non Dimmable</p> <ul style="list-style-type: none"> ○ F023M22A001 ● F023M22A006 ● F023M22A012 ● F023M22A018 ● F023M22A030 ● F023M22A033 <p>1-10V</p> <ul style="list-style-type: none"> ○ F023M22B001 ● F023M22B006 ● F023M22B012 ● F023M22B018 ● F023M22B030 ● F023M22B033 <p>Dali</p> <ul style="list-style-type: none"> ○ F023M22D001 ● F023M22D006 ● F023M22D012 ● F023M22D018 ● F023M22D030 ● F023M22D033 | <p>3000K
Non Dimmable</p> <ul style="list-style-type: none"> ○ F023M32A001 ● F023M32A006 ● F023M32A012 ● F023M32A018 ● F023M32A030 ● F023M32A033 <p>1-10V</p> <ul style="list-style-type: none"> ○ F023M32B001 ● F023M32B006 ● F023M32B012 ● F023M32B018 ● F023M32B030 ● F023M32B033 <p>Dali</p> <ul style="list-style-type: none"> ○ F023M32D001 ● F023M32D006 ● F023M32D012 ● F023M32D018 ● F023M32D030 ● F023M32D033 | <p>4000K
Non Dimmable</p> <ul style="list-style-type: none"> ○ F023M42A001 ● F023M42A006 ● F023M42A012 ● F023M42A018 ● F023M42A030 ● F023M42A033 <p>1-10V</p> <ul style="list-style-type: none"> ○ F023M42B001 ● F023M42B006 ● F023M42B012 ● F023M42B018 ● F023M42B030 ● F023M42B033 <p>Dali</p> <ul style="list-style-type: none"> ○ F023M42D001 ● F023M42D006 ● F023M42D012 ● F023M42D018 ● F023M42D030 ● F023M42D033 |
|--|--|--|

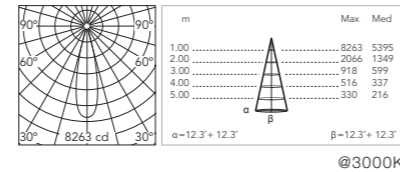

Optic Flood

Power Led: 17,5W - 1890 lm ≠ FIXT 1342 lm - 2700K/CRI>80 - 220-240V / 17,5W - 1960 lm ≠ FIXT 1392 lm - 3000K/CRI>80 - 220-240V / 17,5W - 2030 lm ≠ FIXT 1442 lm - 4000/CRI>80 - 220-240V

- | | | |
|--|--|--|
| <p>2700K
Non Dimmable</p> <ul style="list-style-type: none"> ○ F023M23A001 ● F023M23A006 ● F023M23A012 ● F023M23A018 ● F023M23A030 ● F023M23A033 <p>1-10V</p> <ul style="list-style-type: none"> ○ F023M23B001 ● F023M23B006 ● F023M23B012 ● F023M23B018 ● F023M23B030 ● F023M23B033 <p>Dali</p> <ul style="list-style-type: none"> ○ F023M23D001 ● F023M23D006 ● F023M23D012 ● F023M23D018 ● F023M23D030 ● F023M23D033 | <p>3000K
Non Dimmable</p> <ul style="list-style-type: none"> ○ F023M33A001 ● F023M33A006 ● F023M33A012 ● F023M33A018 ● F023M33A030 ● F023M33A033 <p>1-10V</p> <ul style="list-style-type: none"> ○ F023M33B001 ● F023M33B006 ● F023M33B012 ● F023M33B018 ● F023M33B030 ● F023M33B033 <p>Dali</p> <ul style="list-style-type: none"> ○ F023M33D001 ● F023M33D006 ● F023M33D012 ● F023M33D018 ● F023M33D030 ● F023M33D033 | <p>4000K
Non Dimmable</p> <ul style="list-style-type: none"> ○ F023M43A001 ● F023M43A006 ● F023M43A012 ● F023M43A018 ● F023M43A030 ● F023M43A033 <p>1-10V</p> <ul style="list-style-type: none"> ○ F023M43B001 ● F023M43B006 ● F023M43B012 ● F023M43B018 ● F023M43B030 ● F023M43B033 <p>Dali</p> <ul style="list-style-type: none"> ○ F023M43D001 ● F023M43D006 ● F023M43D012 ● F023M43D018 ● F023M43D030 ● F023M43D033 |
|--|--|--|

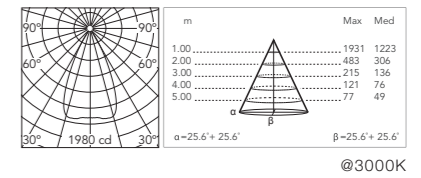

Designed by Philippe Starck





In Vitro Unplugged



In Vitro Bollard



In Vitro Suspension

Famiglia / Family

In Vitro Unplugged



Led Edge Lighting
2,5W
115 lm - 2700K/CRI 80
124 lm - 3000K/CRI 80

In Vitro Bollard



Led Edge Lighting
11W
667 lm - 2700K/CRI 80
714 lm - 3000K/CRI 80

In Vitro Wall



Led Edge Lighting
11W
667 lm - 2700K/CRI 80
714 lm - 3000K/CRI 80

In Vitro Ceiling



Led Edge Lighting
13W
799 lm - 2700K/CRI 80
855 lm - 3000K/CRI 80

In Vitro Suspended



Led Edge Lighting
13W
799 lm - 2700K/CRI 80
855 lm - 3000K/CRI 80

Colori / Colours



01 White



12 Forest Green



13 Pale Green

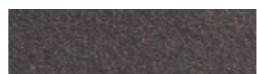

18 Deep Brown



25 Terracotta



30 Black

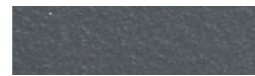

33 Anthracite

Descrizione / Description

Apparecchi di illuminazione per installazione a terra, parete, plafone, sospensione e lampada portatile, a luce diffusa per uso esterno.

Diffusore opalino integrato nella testa e vetro estetico di protezione esterno in borosilicato trasparente. Le parti strutturali dell'apparecchio sono realizzate in alluminio pressofuso ed estruso trattato con procedimento di conversione chimica al fine di una efficiente resistenza agli agenti atmosferici. Il corpo è verniciato a polvere e disponibile in varie finiture.

Sorgente luminosa a LED integrata con tecnologia ottica Edge Lighting per garantire una perfetta uniformità luminosa. Driver integrato nel corpo dell'apparecchio disponibile per controllo ON/OFF e dimmerabile.

La versione bollard è fornita con un connettore stagno per il collegamento alla rete elettrica. L'apparecchio è installabile su qualsiasi pavimento per mezzo di tasselli da scegliersi a cura dell'installatore in funzione della tipologia di superficie. Disponibile come accessorio da ordinare separatamente la cassaforma per l'installazione su una pavimentazione da gettare con plinto di cemento.

La versione unplugged è dotata di pratica maniglia colorata in silicone e facilmente ricaricabile tramite cavo Micro USB-C di 120 cm di lunghezza. Il driver dimmerabile è alloggiato nel corpo dell'apparecchio con sistema touch-dimm integrato accessibile tramite sensore ottico posizionato sulla testa. Attraverso un semplice tocco è possibile regolare l'intensità luminosa della lampada in 4 step di dimmerazione, garantendo un'emissione continua fino a 6 ore.

Luminaires for floor, wall and suspended installation, and portable luminaire, with diffused light for outdoor use. Opalescent diffuser integrated in the head and external transparent borosilicate safety glass.

The structural parts of the luminaire are made of extruded die-cast aluminum, treated with a chemical conversion procedure to ensure effective resistance to atmospheric conditions. The body is powder coated and comes in various finishes.

Integrated LED light source with Edge Lighting optical technology to ensure perfect light uniformity. Driver integrated in the luminaire body available for ON/OFF and dimmable control.

Bollard version comes with a watertight plug for power supply connection. The luminaire may be installed on any type of flooring using anchors, to be selected by the installer depending on the type of surface. Accessory box for installation on flooring to be concreted sold separately.

Unplugged version is equipped with a practical, colored silicone handle and is easily recharged with a 120cm long Micro USB-C cable. Dimmable driver in the body of the luminaire with an integrated touch-dim system, accessible through an optical switch sensor located on the head. With a simple touch, light intensity can be adjusted through a 4-step dimming function, ensuring a continuous emission for up to 6 hours.

In Vitro Unplugged

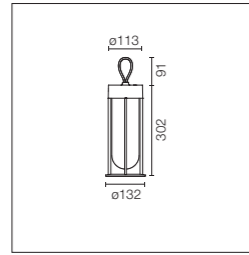

Versione portatile dotata di maniglia per il trasporto. Driver Dimmerabile 5/100÷240V/50-60Hz integrato nel corpo dell'apparecchio con sensore ottico touch sulla testa con regolazione dell'intensità luminosa in 4 step di dimmerazione: 100%-50%-3%-OFF. Ricaricabile tramite cavo Micro USB-C di 120 cm di lunghezza che garantisce un'emissione continua fino a 6 ore. Caricatore con prese intercambiabili EUR, UK, USA.

Portable version equipped with a carrying handle. Adjustable driver 5/100÷240V/50-60Hz integrated in the body of the luminaire with optical switch sensor on the head and with a 4-step dimming function: 100%-50%-3%-OFF. Rechargeable with a 120cm long Micro USB-C cable ensuring continuous emission for up to 6 hours. Charger with interchangeable EUR, UK and USA plugs.

Led Edge Lighting: 2,5W - 182 lm ≠ FIXT 115 lm - 2700K/CRI 90 - 100-240V/V5 / 2,5W - 195 lm ≠ FIXT 124 lm - 3000K/CRI 90 - 100-240V/V5

2700K

- Touch Dimm
- F018E21K001
 - F018E21K012
 - F018E21K013
 - F018E21K018
 - F018E21K025
 - F018E21K030
 - F018E21K033

3000K

- Touch Dimm
- F018E31K001
 - F018E31K012
 - F018E31K013
 - F018E31K018
 - F018E31K025
 - F018E31K030
 - F018E31K033

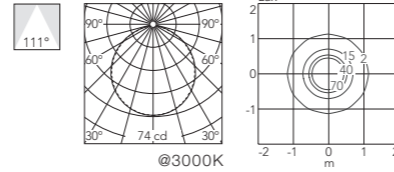

In Vitro Bollard 1

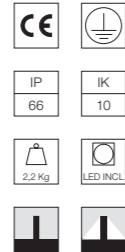
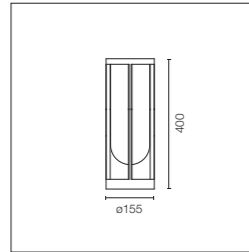

Alimentazione elettrica ON/OFF o dimmerabile 220-240V integrata. L'apparecchio è fornito con un connettore stagno per il collegamento alla rete elettrica. L'apparecchio è installabile su qualsiasi pavimento per mezzo di tasselli. Cassaforma per l'installazione su pavimentazione da gettare con plinto di cemento da ordinare separatamente.

Integrated 220-240V ON/OFF or dimmable electrical power. The unit comes with a watertight plug for connection to the electrical network. The device may be installed on any flooring with anchors. Box for installation on flooring laid over concrete sold separately.

Led Edge Lighting: 11W - 1150 lm ≠ FIXT 667 lm - 2700K/CRI 80 - 220-240V / 11W - 1230 lm ≠ FIXT 714 lm - 3000K/CRI 80 - 220-240V

2700K

- Non Dimmable
- F018A21A001
 - F018A21A012
 - F018A21A013
 - F018A21A018
 - F018A21A025
 - F018A21A030
 - F018A21A033
- 1-10V
- F018A21B001
 - F018A21B012
 - F018A21B013
 - F018A21B018
 - F018A21B025
 - F018A21B030
 - F018A21B033
- Dali
- F018A21D001
 - F018A21D012
 - F018A21D013
 - F018A21D018
 - F018A21D025
 - F018A21D030
 - F018A21D033

3000K

- Non Dimmable
- F018A31A001
 - F018A31A012
 - F018A31A013
 - F018A31A018
 - F018A31A025
 - F018A31A030
 - F018A31A033
- 1-10V
- F018A31B001
 - F018A31B012
 - F018A31B013
 - F018A31B018
 - F018A31B025
 - F018A31B030
 - F018A31B033
- Dali
- F018A31D001
 - F018A31D012
 - F018A31D013
 - F018A31D018
 - F018A31D025
 - F018A31D030
 - F018A31D033

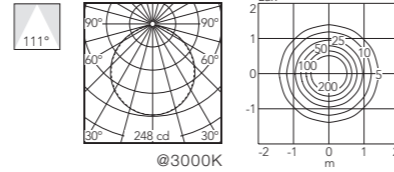

In Vitro Bollard 2

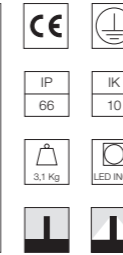
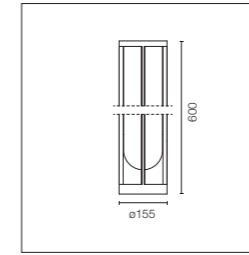

Alimentazione elettrica ON/OFF o dimmerabile 220-240V integrata. L'apparecchio è fornito con un connettore stagno per il collegamento alla rete elettrica. L'apparecchio è installabile su qualsiasi pavimento per mezzo di tasselli. Cassaforma per l'installazione su pavimentazione da gettare con plinto di cemento da ordinare separatamente.

Integrated 220-240V ON/OFF or dimmable electrical power. The unit comes with a watertight plug for connection to the electrical network. The device may be installed on any flooring with anchors. Box for installation on flooring laid over concrete sold separately.

Led Edge Lighting: 11W - 1150 lm ≠ FIXT 667 lm - 2700K/CRI 80 - 220-240V / 11W - 1230 lm ≠ FIXT 714 lm - 3000K/CRI 80 - 220-240V

2700K

Non Dimmable

- F018A22A001
 - F018A22A012
 - F018A22A013
 - F018A22A018
 - F018A22A025
 - F018A22A030
 - F018A22A033
- 1-10V
- F018A22B001
 - F018A22B012
 - F018A22B013
 - F018A22B018
 - F018A22B025
 - F018A22B030
 - F018A22B033
- Dali
- F018A22D001
 - F018A22D012
 - F018A22D013
 - F018A22D018
 - F018A22D025
 - F018A22D030
 - F018A22D033

3000K

Non Dimmable

- F018A32A001
 - F018A32A012
 - F018A32A013
 - F018A32A018
 - F018A32A025
 - F018A32A030
 - F018A32A033
- 1-10V
- F018A32B001
 - F018A32B012
 - F018A32B013
 - F018A32B018
 - F018A32B025
 - F018A32B030
 - F018A32B033
- Dali
- F018A32D001
 - F018A32D012
 - F018A32D013
 - F018A32D018
 - F018A32D025
 - F018A32D030
 - F018A32D033

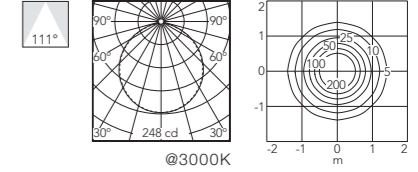

In Vitro Bollard 3

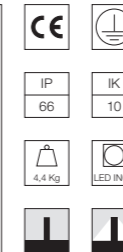
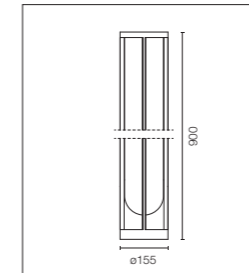

Alimentazione elettrica ON/OFF o dimmerabile 220-240V integrata. L'apparecchio è fornito con un connettore stagno per il collegamento alla rete elettrica. L'apparecchio è installabile su qualsiasi pavimento per mezzo di tasselli. Cassaforma per l'installazione su pavimentazione da gettare con plinto di cemento da ordinare separatamente.

Integrated 220-240V ON/OFF or dimmable electrical power. The unit comes with a watertight plug for connection to the electrical network. The device may be installed on any flooring with anchors. Box for installation on flooring laid over concrete sold separately.

Led Edge Lighting: 11W - 1150 lm ≠ FIXT 667 lm - 2700K/CRI 80 - 220-240V / 11W - 1230 lm ≠ FIXT 714 lm - 3000K/CRI 80 - 220-240V

2700K

Non Dimmable

- F018A23A001
 - F018A23A012
 - F018A23A013
 - F018A23A018
 - F018A23A025
 - F018A23A030
 - F018A23A033
- 1-10V
- F018A23B001
 - F018A23B012
 - F018A23B013
 - F018A23B018
 - F018A23B025
 - F018A23B030
 - F018A23B033
- Dali
- F018A23D001
 - F018A23D012
 - F018A23D013
 - F018A23D018
 - F018A23D025
 - F018A23D030
 - F018A23D033

3000K

Non Dimmable

- F018A33A001
 - F018A33A012
 - F018A33A013
 - F018A33A018
 - F018A33A025
 - F018A33A030
 - F018A33A033
- 1-10V
- F018A33B001
 - F018A33B012
 - F018A33B013
 - F018A33B018
 - F018A33B025
 - F018A33B030
 - F018A33B033
- Dali
- F018A33D001
 - F018A33D012
 - F018A33D013
 - F018A33D018
 - F018A33D025
 - F018A33D030
 - F018A33D033

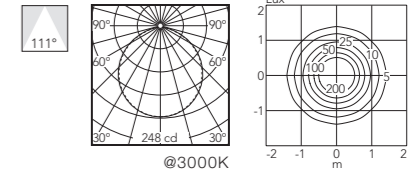

In Vitro Wall

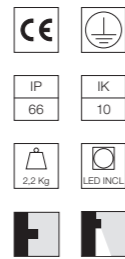
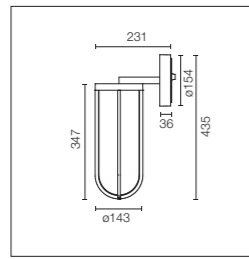

Attacco a parete. Sorgente luminosa inclusa. Alimentazione elettrica ON/OFF o dimmerabile 220-240V integrata.

Wall mount. Light source included. Integrated 220-240V ON/OFF or dimmable electrical power.

Led Edge Lighting: 11W - 1150 lm ≠ FIXT 667 lm - 2700K/CRI 80 - 220-240V / 11W - 1230 lm ≠ FIXT 714 lm - 3000K/CRI 80 - 220-240V

2700K

Non Dimmable

- F018B22A001
- F018B22A012
- F018B22A013
- F018B22A018
- F018B22A025
- F018B22A030
- F018B22A033

1-10V

- F018B22B001
- F018B22B012
- F018B22B013
- F018B22B018
- F018B22B025
- F018B22B030
- F018B22B033

Dali

- F018B22D001
- F018B22D012
- F018B22D013
- F018B22D018
- F018B22D025
- F018B22D030
- F018B22D033

3000K

Non Dimmable

- F018B32A001
- F018B32A012
- F018B32A013
- F018B32A018
- F018B32A025
- F018B32A030
- F018B32A033

1-10V

- F018B32B001
- F018B32B012
- F018B32B013
- F018B32B018
- F018B32B025
- F018B32B030
- F018B32B033

Dali

- F018B32D001
- F018B32D012
- F018B32D013
- F018B32D018
- F018B32D025
- F018B32D030
- F018B32D033

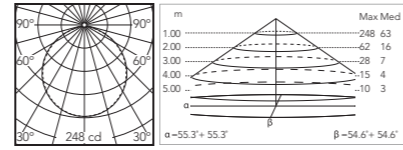

@3000K

In Vitro Ceiling

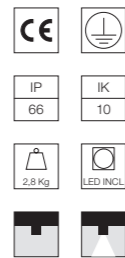
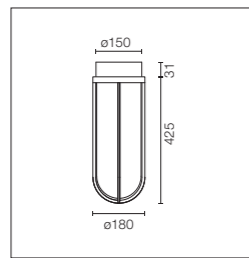

Sorgente luminosa inclusa. Attacco a soffitto. Alimentazione elettrica ON/OFF o dimmerabile 220-240V inclusa.

Light source included. Ceiling mount. Integrated 220-240V ON/OFF or dimmable electrical power.

Led Edge Lighting: 13W - 1378 lm ≠ FIXT 799 lm - 2700K/CRI 80 - 220-240V / 13W - 1474 lm ≠ FIXT 855 lm - 3000K/CRI 80 - 220-240V

2700K

Non Dimmable

- F018C25A001
- F018C25A012
- F018C25A013
- F018C25A018
- F018C25A025
- F018C25A030
- F018C25A033

1-10V

- F018C25B001
- F018C25B012
- F018C25B013
- F018C25B018
- F018C25B025
- F018C25B030
- F018C25B033

Dali

- F018C25D001
- F018C25D012
- F018C25D013
- F018C25D018
- F018C25D025
- F018C25D030
- F018C25D033

3000K

Non Dimmable

- F018C35A001
- F018C35A012
- F018C35A013
- F018C35A018
- F018C35A025
- F018C35A030
- F018C35A033

1-10V

- F018C35B001
- F018C35B012
- F018C35B013
- F018C35B018
- F018C35B025
- F018C35B030
- F018C35B033

Dali

- F018C35D001
- F018C35D012
- F018C35D013
- F018C35D018
- F018C35D025
- F018C35D030
- F018C35D033

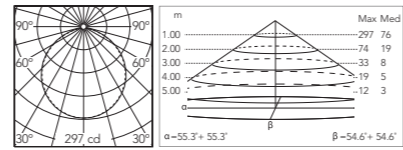

@3000K

In Vitro Suspension

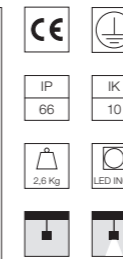
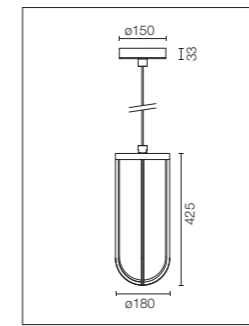

Installazione a sospensione. Sorgente luminosa inclusa. Alimentazione elettrica ON/OFF o dimmerabile 220-240V integrata all'interno di base a soffitto dedicata. Lunghezza cavo a sospensione 1000 mm.

Hanging version. Light source included. 220-240V ON/OFF or dimmable electrical power integrated within the dedicated ceiling attachment. Hanging cable length 1000 mm.

Led Edge Lighting: 13W - 1378 lm ≠ FIXT 799 lm - 2700K/CRI 80 - 220-240V / 13W - 1474 lm ≠ FIXT 855 lm - 3000K/CRI 80 - 220-240V

2700K

Non Dimmable

- F018D25A001
- F018D25A012
- F018D25A013
- F018D25A018
- F018D25A025
- F018D25A030
- F018D25A033

1-10V

- F018D25B001
- F018D25B012
- F018D25B013
- F018D25B018
- F018D25B025
- F018D25B030
- F018D25B033

Dali

- F018D25D001
- F018D25D012
- F018D25D013
- F018D25D018
- F018D25D025
- F018D25D030
- F018D25D033

3000K

Non Dimmable

- F018D35A001
- F018D35A012
- F018D35A013
- F018D35A018
- F018D35A025
- F018D35A030
- F018D35A033

1-10V

- F018D35B001
- F018D35B012
- F018D35B013
- F018D35B018
- F018D35B025
- F018D35B030
- F018D35B033

Dali

- F018D35D001
- F018D35D012
- F018D35D013
- F018D35D018
- F018D35D025
- F018D35D030
- F018D35D033

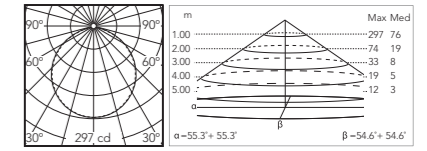

@3000K

Accessori / Accessories

In Vitro Bollard

Dispositivo di protezione per il sovraccarico. 275 Vac. Corrente massima di scarica 10KA (8/29us). Massima corrente operativa 5A. Adatto per la connessione in serie. IP66.

Surge protection device. 275Vac. Maximum discharge current 10KA (8/20us). Maximum operating current 5A. Suitable for series connection. IP66.

F990E00A000

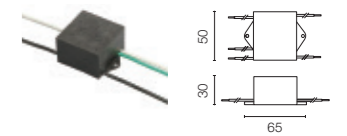

Sistema di giunzione IP68 H2O Stop anti-condensa a 2 vie 4 poli.

2 way terminal block 4 poles IP68 H2O Stop.

F990C00A000

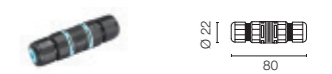

Cassaforma per l'installazione a terra.

Box for ground installation.

F018Z000000

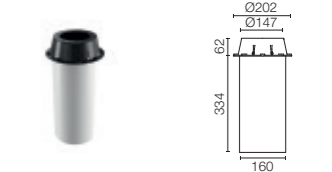

Mile

Designed by Antonio Citterio





Mile Wall

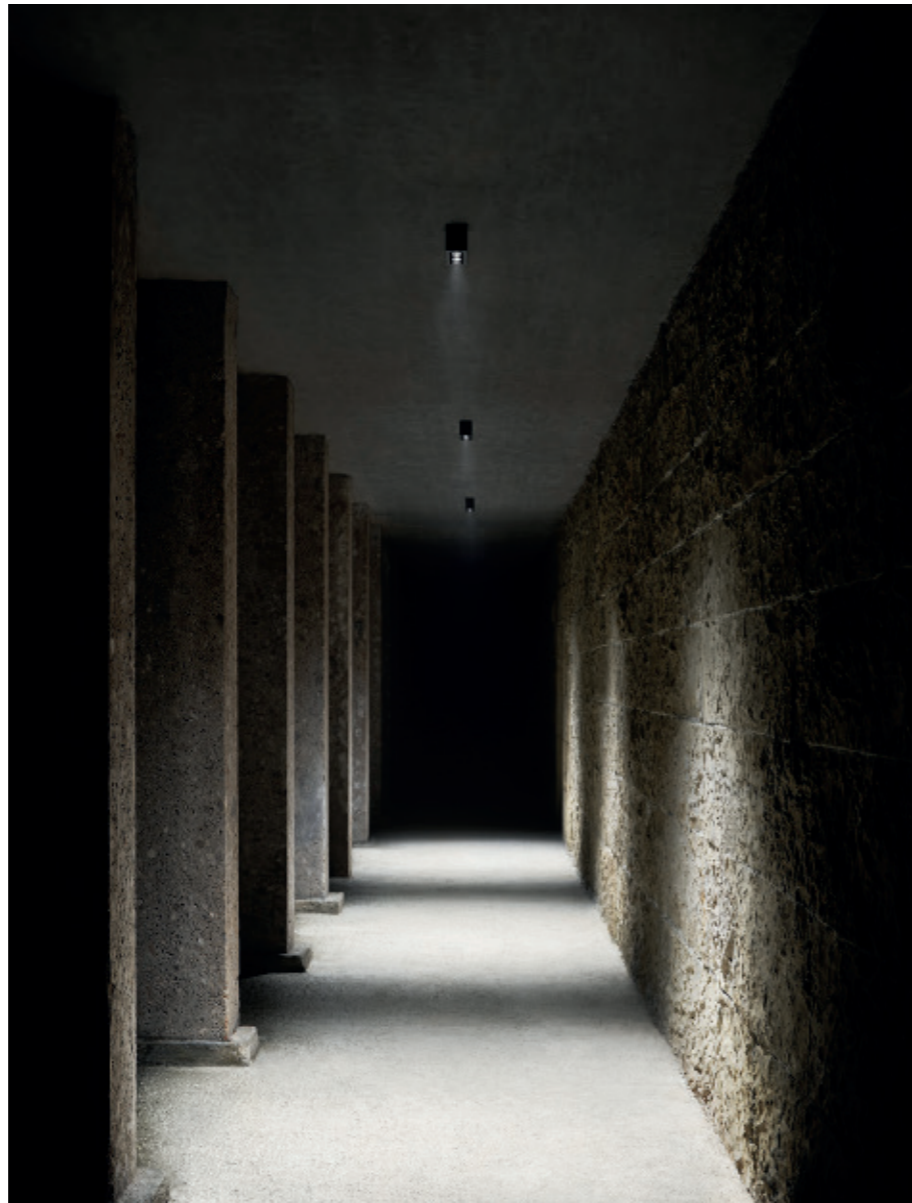

Mile Ceiling 1



Mile Bollard 1

Famiglia / Family

Mile Bollard 1 600

Mono / Double



Mile Bollard 2 600

Mono / Double



Mile Bollard 1 900

Mono / Double



Mile Bollard 2 900

Mono / Double



Mid - Power Led
4,9W
283 lm - 2700K/CRI 80
294 lm - 3000K/CRI 80
305 lm - 4000K/CRI 80

Mid - Power Led
9,8W
2x283 lm - 2700K/CRI 80
2x294 lm - 3000K/CRI 80
2x305 lm - 4000K/CRI 80

Mid - Power Led
7,8W
603 lm - 2700K/CRI 80
627 lm - 3000K/CRI 80
651 lm - 4000K/CRI 80

Mid - Power Led
15,6W
2x603 lm - 2700K/CRI 80
2x627 lm - 3000K/CRI 80
2x651 lm - 4000K/CRI 80

Colori / Colours

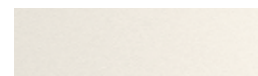

*00 Primer



01 White



06 Grey



**12 Forest Green



18 Deep Brown



30 Black

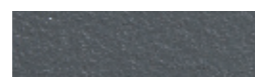

33 Anthracite

* Solo per le versioni Wall, Path e Ceiling / Only for Wall, Path and Ceiling versions.

** Solo per le versioni Wall, Bollard e Path / Only for Wall, Bollard and Path versions.

Mile Path 1



Mid - Power Led
3,7W
up to 100 lm - 2700K/CRI 80
up to 104 lm - 3000K/CRI 80
up to 108 lm - 4000K/CRI 80

Mile Path 2



Mid - Power Led
7,6W
up to 100 lm - 2700K/CRI 80
up to 179 lm - 3000K/CRI 80
up to 172 lm - 4000K/CRI 80

Mile Wall 1

Up / Down / Up&Down



Mid - Power Led
4,9W
283 lm - 2700K/CRI 80
294 lm - 3000K/CRI 80
305 lm - 4000K/CRI 80

Mid - Power Led
8,1W
2x283 lm - 2700K/CRI 80
2x294 lm - 3000K/CRI 80
2x305 lm - 4000K/CRI 80

Washer

Up / Down / Up&Down

Mid - Power Led
4,9W
291 lm - 2700K/CRI 80
303 lm - 3000K/CRI 80
314 lm - 4000K/CRI 80

Mid - Power Led
8,1W
2x291 lm - 2700K/CRI 80
2x303 lm - 3000K/CRI 80
2x314 lm - 4000K/CRI 80

Mile Wall 2

Up / Down / Up&Down



Mid - Power Led
7,8W
603 lm - 2700K/CRI 80
627 lm - 3000K/CRI 80
651 lm - 4000K/CRI 80

Mid - Power Led
13,5W
2x603 lm - 2700K/CRI 80
2x627 lm - 3000K/CRI 80
2x651 lm - 4000K/CRI 80

Washer

Up / Down / Up&Down

Mid - Power Led
6,4W
453 lm - 2700K/CRI 80
471 lm - 3000K/CRI 80
489 lm - 4000K/CRI 80

Mid - Power Led
10,5W
2x453 lm - 2700K/CRI 80
2x471 lm - 3000K/CRI 80
2x489 lm - 4000K/CRI 80

Mile Ceiling 1



Mile Ceiling 2



Mile Recessed 1



Mid - Power Led
11W
736 lm - 2700K/CRI 80
759 lm - 3000K/CRI 80
791 lm - 4000K/CRI 80

Mile Recessed 2



Mid - Power Led
15W
1032 lm - 2700K/CRI 80
1344 lm - 3000K/CRI 80
1400 lm - 4000K/CRI 80

Descrizione

Mile Bollard

Collezione di paletti luminosi per esterno dal design rigoro-so e minimale con sorgente luminosa a LED, abbinabili alle versioni a parete.

Versione bollard monodirezionale o bidirezionale, disponibile in due altezze e in due larghezze in base alla sorgente lumi-nosa e alla potenza richiesta, caratterizzata da una cornice rigorosa in estruso di alluminio senza viti a vista, con base di rialzo a terra per una più semplice e veloce installazione. Le viterie di fissaggio della testa sono in acciaio inox AISI 316L. Disponibile in differenti finiture con rivestimento a doppio strato di polveri e sottoposte a trattamento di conversione chimica per proteggere contro la corrosione. Il diffusore è in policarbonato trasparente stabilizzato ai raggi UV.

Lo schermo riflettore asimmetrico è in alluminio purissimo, ossidato e brillantato e contiene la sorgente led in posi-zione arretrata per la riduzione dell'abbagliamento diretto; l'emissione luminosa asimmetrica direzionata verso il basso rende l'apparecchio in linea con le vigenti leggi in materia di inquinamento luminoso.

Le versioni Bollard possono essere installate facilmente a terra su qualsiasi pavimento con tasselli, oppure utilizzando l'accessorio dedicato piastra di ancoraggio per rendere la base del prodotto totalmente solidale con la pavimentazione.

Mile Path

Collezione di apparecchio a parete per uso segnapasso in esterno dal design rigoroso e minimale con sorgente lumino-sa a LED, abbinabili alle versioni a parete e bollard. Disponibile in due diverse dimensioni e in differenti finiture con un rivestimento a doppio strato di polveri. La versione Primer va verniciata dopo l'installazione con normali colorazioni a base acquosa (tempere, stucchi, vernici ad acqua) per garantire la massima integrazione con l'archi-tettura.

Le viterie di fissaggio sono in acciaio inox AISI 316L. Il diffu-sore è in policarbonato trasparente stabilizzato ai raggi UV. Lo schermo riflettore asimmetrico è in alluminio verniciato nero per la riduzione dell'abbagliamento diretto dato dalle riflessioni e contiene la sorgente led in posizione arretrata; l'emissione luminosa asimmetrica direzionata verso il basso rende l'apparecchio in linea con le vigenti leggi in materia di inquinamento luminoso. Staffa di fissaggio a parete inclusa.

Mile Wall

Famiglia completa di apparecchi di illuminazione a parete dal design rigoroso e minimale con sorgente luminosa a LED, caratterizzato da una fascia decorativa in alluminio pressofu-so a bassissimo contenuto di rame con buone caratteristiche meccaniche unite ad una buona resistenza alla corrosione data dal trattamento di conversione chimica superficiale. Disponibile in due diverse dimensioni e in differenti finiture con un rivestimento a doppio strato di polveri. La versione Primer va verniciata dopo l'installazione con normali colorazioni a base acquosa (tempere, stucchi, vernici ad acqua) per garantire la massima integrazione con l'archi-tettura.

Le viterie di fissaggio sono in acciaio inox AISI 316L. Il dif-fusore perfettamente complanare alla fascia decorativa è in policarbonato trasparente stabilizzato ai raggi UV. Lo schermo riflettore asimmetrico è in alluminio purissimo, ossidato e brillantato e contiene la sorgente led in posizione arretrata per la riduzione dell'abbagliamento diretto. L'ottica asimmetrica è progettata per garantire una vasta gamma di prestazioni luminose e l'utilizzo flessibile in diversi contesti architettonici. Sono disponibili le versioni monoe-

missione con luce direzionata verso l'alto o verso il basso e le versioni biemissione, ognuna declinata secondo due diffe-renti soluzioni illuminotecniche: per illuminazione focalizzata sul lavaggio luminoso della parete (washer) o per illuminazio-ne asimmetrica ad esempio in caso di porticati o androni con l'utilizzo della versione con luce verso l'alto, dove il soffitto diventa esso stesso diffusore dal massimo comfort. La ver-sione biemissione è disponibile sia con ottiche identiche, sia con ottiche miste asimmetrica + washer.

Mile Ceiling

Collezione di apparecchi a soffitto in esterno dal design rigoroso e minimale con sorgente luminosa a LED, abbinabili alle versioni a parete, bollard e path. Disponibile in tre diverse dimensioni e in differenti finiture con un rivestimento a doppio strato di polveri.

La versione Primer va verniciata dopo l'installazione con normali colorazioni a base acquosa (tempere, stucchi, vernici ad acqua) per garantire la massima integrazione con l'archi-tettura.

Il gruppo ottico è appositamente progettato per garantire il massimo comfort visivo e la riduzione dell'abbagliamento diretto senza rinunciare all'efficienza: la sorgente luminosa è composta da power led arretrati, le lenti in policarbona-to trasparente assicurano un fascio di luce controllato e omogeneo, e i riflettori conici in policarbonato nero lucido forniscono una schermatura con angoli di cut-off estremi, il tutto in dimensioni molto ridotte.

Il gruppo ottico è disponibile in quattro aperture di fascio differenziate, permettendone un'ampia gamma di utilizzo e flessibilità nei più vari contesti architettonici: sia nel caso di fasci intensivi che di effetti di luce diffusa, il controllo ottico è sempre eccezionale e la luce spuria è totalmente assente. Le viterie di fissaggio sono in acciaio inox AISI 316L. Staffa di fissaggio a soffitto inclusa.

Mile Recessed

Collezione di apparecchi a incasso a soffitto in esterno dal design rigoroso e minimale con sorgente luminosa a LED, abbinabili alle versioni a soffitto, parete, bollard e path. Disponibile in tre diverse dimensioni e in differenti finiture con un rivestimento a doppio strato di polveri.

La versione Primer va verniciata dopo l'installazione con normali colorazioni a base acquosa (tempere, stucchi, vernici ad acqua) per garantire la massima integrazione con l'archi-tettura.

Come per le versioni a soffitto, il gruppo ottico è appositamente progettato per garantire il massimo comfort visivo e la riduzione dell'abbagliamento diretto senza rinunciare all'efficienza: la sorgente luminosa è composta da power led arretrati, le lenti in policarbonato trasparente assicurano un fascio di luce controllato e omogeneo, e i riflettori conici in policarbonato nero lucido forniscono una schermatura con angoli di cut-off estremi, il tutto in dimensioni molto ridotte. Il gruppo ottico è disponibile in quattro aperture di fascio differenziate, permettendone un'ampia gamma di utilizzo e flessibilità nei più vari contesti architettonici: sia nel caso di fasci intensivi che di effetti di luce diffusa, il controllo ottico è sempre eccezionale e la luce spuria è totalmente assente. L'apparecchio è installabile in controsoffitto mediante molle di fissaggio in dotazione; la cornice di battuta di spessore minimo garantisce la perfetta finitura estetica dell'apparecchio nel soffitto. Disponibile come accessorio, per soffitti in muratura o in ce-mento armato, l'apposita cassaforma per gettata in acciaio zincato.

Description

Mile Bollard

Collection of outdoor bollards with a rigorous, minimal design and LED light source that can be combined with wall versions.

Uni- or bi-directional bollard version, available in two heights and widths, based on light source and power requirements. The rigid frame is made of extruded aluminum with no visible screws, and the base rises above the ground for a quick, simple installation. The head anchoring hardware is made of AISI 316L stainless steel.

Available in various finishes with a double layer of powder coating and chemical conversion treatment to protect it against corrosion.

The diffuser is made of transparent, UV-stabilized polycar-bonate.

The asymmetric reflecting screen is made of pure, oxidized and polished aluminum, with LED source in a rear position to reduce direct glare. The downward, asymmetric light emission ensures the luminaire’s compliance with existing light pollution laws.

Bollard versions may be easily installed on any flooring on the ground with anchors, or with the dedicated anchoring plate accessory to completely integrate the base of the product with the pavement.

Mile Path

Collection of outdoor wall luminaires with a rigorous, minimal design and LED light source that can be combined with wall and bollard versions.

Available in two sizes and various finishes with a double layer of powder coating.

Primer version to be painted after installation with regular water-based colors (tempera, stucco, water-based paints) to ensure flawless integration with the building.

The anchoring hardware is made of AISI 316L stainless steel. Diffuser is made of transparent, UV-stabilized polycarbonate. The asymmetric, reflecting screen is made of aluminum pain-ted in black to reduce direct glare from reflections. It holds the LED source in a rear position. The downward, asymme-tric light emission ensures the luminaire’s compliance with existing light pollution laws.

Wall mounting bracket included.

Mile Wall

Complete family of wall luminaires with a rigorous, minimal design with LED light source, a design characterized by a die-cast aluminum trim with very low copper content and good mechanical features combined with good resistance against corrosion thanks to the surface chemical conversion treatment.

Available in two sizes and various finishes with a double layer of powder coating.

Primer version to be painted after installation with regular water-based colors (tempera, stucco, water-based paints) to ensure flawless integration with the building.

The anchoring hardware is made of AISI 316L stainless steel. The diffuser is perfectly flush with the decorative band and is made of transparent, UV-stabilized polycarbonate.

The asymmetric, reflecting screen is made of pure, oxidized and polished aluminum, with LED source in a rear position to reduce direct glare.

Its asymmetrical optical unit is designed to ensure a wide range of lighting features and flexible use in different ar-chitectural settings. Single-emission version directing light upwards or downwards and dual-emission version available. Each version is available in two different lighting solutions: wall-washer lighting or asymmetric lighting. For instance, by

using the version with light directed upwards in porticos or entrance halls, the ceiling itself becomes a diffuser, offering absolute comfort. Dual emission version is available with both identical optical units and mixed, asymmetric + washer optical units.

Mile Ceiling

Outdoor ceiling-mounted lights collection, with a rigorous, minimal design and LED light source that can be combined with wall, bollard and path versions.

Available in three different sizes and various finishes with a double layer of powder coating.

Primer version to be painted after installation with regular water-based colors (tempera, stucco, water-based paints) to ensure flawless integration with the building.

The optical unit is specifically designed to ensure maximum visual comfort and direct glare reduction without compromi-sing overall efficiency: the light source comprises rear power LEDs; its transparent polycarbonate lenses ensure a control-led and homogeneous beam of light; and the glossy black polycarbonate cone reflectors provide an extreme, sharp-an-gled screening, all in a small footprint.

The optical unit is available in four different beam angles, allowing a wide range of uses and flexibility in the most varied architectural settings: both in the case of intense beams and diffuse light effects, optical control is always exceptional and spurious light is totally absent.

The anchoring hardware is made of AISI 316L stainless steel. Ceiling mounting bracket included.

Mile Recessed

Collection of outdoor, ceiling-mounted, recessed lights with a rigorous, minimal design and LED light source that can be combined with ceiling, wall, bollard and path versions.

Available in three different sizes and various finishes with a double layer of powder coating.

Primer version to be painted after installation with regular water-based colors (tempera, stucco, water-based paints) to ensure flawless integration with the building.

As in ceiling versions, the optical unit is specifically designed to ensure maximum visual comfort and direct glare reduction without compromising overall efficiency: the light source comprises rear power LEDs; its transparent polycarbonate lenses ensure a controlled and homogeneous beam of light; and the glossy black polycarbonate cone reflectors provide an extreme, sharp-angled screening, all in a small footprint.

The optical unit is available in four different beam angles, allowing a wide range of uses and flexibility in the most varied architectural settings: both in the case of intense beams and diffuse light effects, optical control is always exceptional and spurious light is totally absent.

The luminaire can be installed in a drop ceiling using the sup-plied springs. The minimal thickness of the stop frame allows a perfect, aesthetic finish of the luminaire in the ceiling.

The accessory box for installation in galvanized steel for con-creting is available for brick or reinforced concrete ceilings.

Mile Bollard 1 600 Mono

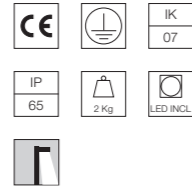
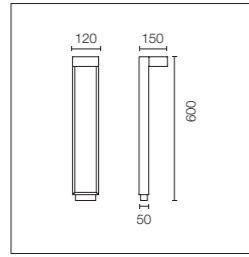

Sorgente luminosa a LED inclusa. Alimentazione elettrica 220-240V ON/OFF integrata. Dotato di uno spezzone di cavo uscente in neoprene e un sistema di giunzione IP68 H₂O Stop anti-condensa a 2 vie. L'apparecchio è installabile su qualsiasi pavimento per mezzo di tasselli. Piastra di ancoraggio per l'installazione su pavimentazione da gettare con plinto di cemento da ordinare separatamente.

LED light source included. Integrated 220-240V ON/OFF electrical power. Equipped with a length of neoprene cable and an IP68 2-way anti-condensation H₂O stop seal system. The device may be installed on any flooring with anchors. Anchoring plate for installation on flooring laid over concrete sold separately.

Mid - Power Led: 4,9W - 427 lm ≠ FIXT 283 lm - 2700K/CRI 80 - 220-240V / 4,9W - 445 lm ≠ FIXT 294 lm - 3000K/CRI 80 - 220-240V / 4,9W - 462 lm ≠ FIXT 305 lm - 4000K/CRI 80 - 220-240V

2700K

- F015G21A001
- F015G21A006
- F015G21A012
- F015G21A018
- F015G21A030
- F015G21A033

3000K

- F015G31A001
- F015G31A006
- F015G31A012
- F015G31A018
- F015G31A030
- F015G31A033

4000K

- F015G41A001
- F015G41A006
- F015G41A012
- F015G41A018
- F015G41A030
- F015G41A033

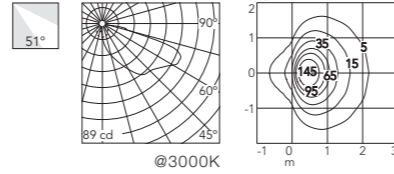

Mile Bollard 1 900 Mono

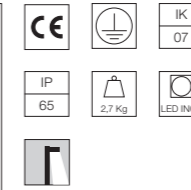
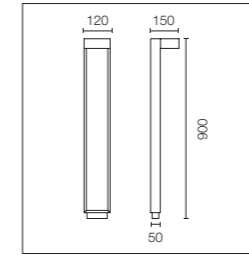

Sorgente luminosa a LED inclusa. Alimentazione elettrica 220-240V ON/OFF integrata. Dotato di uno spezzone di cavo uscente in neoprene e un sistema di giunzione IP68 H₂O Stop anti-condensa a 2 vie. L'apparecchio è installabile su qualsiasi pavimento per mezzo di tasselli. Piastra di ancoraggio per l'installazione su pavimentazione da gettare con plinto di cemento da ordinare separatamente.

LED light source included. Integrated 220-240V ON/OFF electrical power. Equipped with a length of neoprene cable and an IP68 2-way anti-condensation H₂O stop seal system. The device may be installed on any flooring with anchors. Anchoring plate for installation on flooring laid over concrete sold separately.

Mid - Power Led: 4,9W - 427 lm ≠ FIXT 283 lm - 2700K/CRI 80 - 220-240V / 4,9W - 445 lm ≠ FIXT 294 lm - 3000K/CRI 80 - 220-240V / 4,9W - 462 lm ≠ FIXT 305 lm - 4000K/CRI 80 - 220-240V

2700K

- F015H21A001
- F015H21A006
- F015H21A012
- F015H21A018
- F015H21A030
- F015H21A033

3000K

- F015H31A001
- F015H31A006
- F015H31A012
- F015H31A018
- F015H31A030
- F015H31A033

4000K

- F015H41A001
- F015H41A006
- F015H41A012
- F015H41A018
- F015H41A030
- F015H41A033

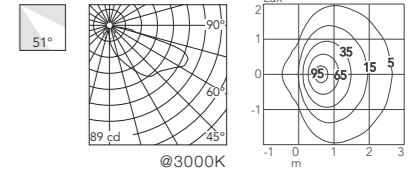

Mile Bollard 1 600 Double

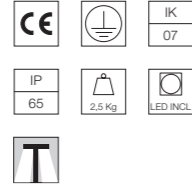
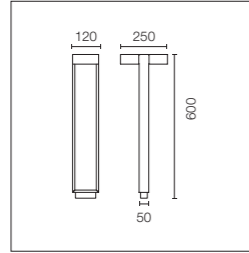

Sorgente luminosa a LED inclusa. Alimentazione elettrica 220-240V ON/OFF integrata. Dotato di uno spezzone di cavo uscente in neoprene e un sistema di giunzione IP68 H₂O Stop anti-condensa a 2 vie. L'apparecchio è installabile su qualsiasi pavimento per mezzo di tasselli. Piastra di ancoraggio per l'installazione su pavimentazione da gettare con plinto di cemento da ordinare separatamente.

LED light source included. Integrated 220-240V ON/OFF electrical power. Equipped with a length of neoprene cable and an IP68 2-way anti-condensation H₂O stop seal system. The device may be installed on any flooring with anchors. Anchoring plate for installation on flooring laid over concrete sold separately.

Mid - Power Led: 9,8W - 2x427 lm ≠ FIXT 2x283 lm - 2700K/CRI 80 - 220-240V / 9,8W - 2x445 lm ≠ FIXT 2x294 lm - 3000K/CRI 80 - 220-240V / 9,8W - 2x462 lm ≠ FIXT 2x305 lm - 4000K/CRI 80 - 220-240V

2700K

- F015G22A001
- F015G22A006
- F015G22A012
- F015G22A018
- F015G22A030
- F015G22A033

3000K

- F015G32A001
- F015G32A006
- F015G32A012
- F015G32A018
- F015G32A030
- F015G32A033

4000K

- F015G42A001
- F015G42A006
- F015G42A012
- F015G42A018
- F015G42A030
- F015G42A033

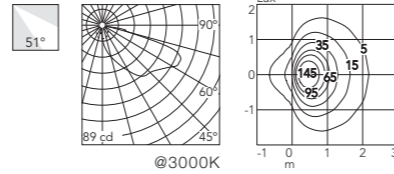

Mile Bollard 1 900 Double

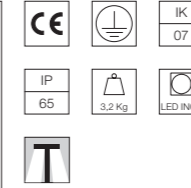
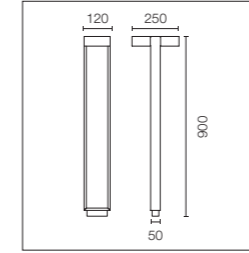

Sorgente luminosa a LED inclusa. Alimentazione elettrica 220-240V ON/OFF integrata. Dotato di uno spezzone di cavo uscente in neoprene e un sistema di giunzione IP68 H₂O Stop anti-condensa a 2 vie. L'apparecchio è installabile su qualsiasi pavimento per mezzo di tasselli. Piastra di ancoraggio per l'installazione su pavimentazione da gettare con plinto di cemento da ordinare separatamente.

LED light source included. Integrated 220-240V ON/OFF electrical power. Equipped with a length of neoprene cable and an IP68 2-way anti-condensation H₂O stop seal system. The device may be installed on any flooring with anchors. Anchoring plate for installation on flooring laid over concrete sold separately.

Mid - Power Led: 9,8W - 2x427 lm ≠ FIXT 2x283 lm - 2700K/CRI 80 - 220-240V / 9,8W - 2x445 lm ≠ FIXT 2x294 lm - 3000K/CRI 80 - 220-240V / 9,8W - 2x462 lm ≠ FIXT 2x305 lm - 4000K/CRI 80 - 220-240V

2700K

- F015H22A001
- F015H22A006
- F015H22A012
- F015H22A018
- F015H22A030
- F015H22A033

3000K

- F015H32A001
- F015H32A006
- F015H32A012
- F015H32A018
- F015H32A030
- F015H32A033

4000K

- F015H42A001
- F015H42A006
- F015H42A012
- F015H42A018
- F015H42A030
- F015H42A033

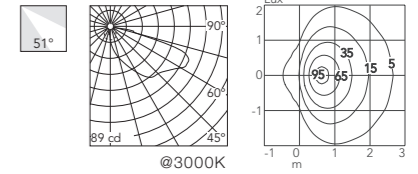

Mile Bollard 2 600 Mono

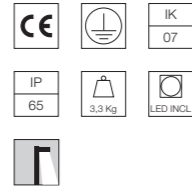
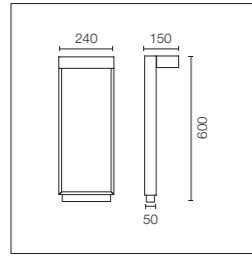

Sorgente luminosa a LED inclusa. Alimentazione elettrica 220-240V ON/OFF integrata. Dotato di uno spezzone di cavo uscente in neoprene e un sistema di giunzione IP68 H₂O Stop anti-condensa a 2 vie. L'apparecchio è installabile su qualsiasi pavimento per mezzo di tasselli. Piastra di ancoraggio per l'installazione su pavimentazione da gettare con plinto di cemento da ordinare separatamente.

LED light source included. Integrated 220-240V ON/OFF electrical power. Equipped with a length of neoprene cable and an IP68 2-way anti-condensation H₂O stop seal system. The device may be installed on any flooring with anchors. Anchoring plate for installation on flooring laid over concrete sold separately.

Mid - Power Led: 7,8W - 838 lm ≠ FIXT 603 lm - 2700K/CRI 80 - 220-240V / 7,8W - 872 lm ≠ FIXT 627 lm - 3000K/CRI 80 - 220-240V / 7,8W - 905 lm ≠ FIXT 651 lm - 4000K/CRI 80 - 220-240V

2700K

- Non Dimmable
- F015J21A001
- F015J21A006
- F015J21A012
- F015J21A018
- F015J21A030
- F015J21A033
- 1-10V
- F015J21B001
- F015J21B006
- F015J21B012
- F015J21B018
- F015J21B030
- F015J21B033
- Dali
- F015J21D001
- F015J21D006
- F015J21D012
- F015J21D018
- F015J21D030
- F015J21D033

3000K

- Non Dimmable
- F015J31A001
- F015J31A006
- F015J31A012
- F015J31A018
- F015J31A030
- F015J31A033
- 1-10V
- F015J31B001
- F015J31B006
- F015J31B012
- F015J31B018
- F015J31B030
- F015J31B033
- Dali
- F015J31D001
- F015J31D006
- F015J31D012
- F015J31D018
- F015J31D030
- F015J31D033

4000K

- Non Dimmable
- F015J41A001
- F015J41A006
- F015J41A012
- F015J41A018
- F015J41A030
- F015J41A033
- 1-10V
- F015J41B001
- F015J41B006
- F015J41B012
- F015J41B018
- F015J41B030
- F015J41B033
- Dali
- F015J41D001
- F015J41D006
- F015J41D012
- F015J41D018
- F015J41D030
- F015J41D033

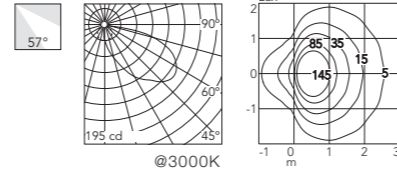

Mile Bollard 2 600 Double

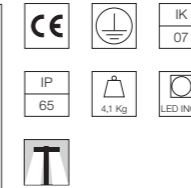
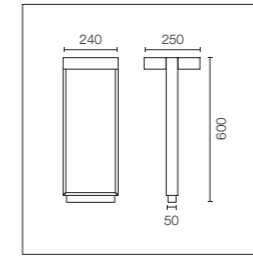

Sorgente luminosa a LED inclusa. Alimentazione elettrica 220-240V ON/OFF integrata. Dotato di uno spezzone di cavo uscente in neoprene e un sistema di giunzione IP68 H₂O Stop anti-condensa a 2 vie. L'apparecchio è installabile su qualsiasi pavimento per mezzo di tasselli. Piastra di ancoraggio per l'installazione su pavimentazione da gettare con plinto di cemento da ordinare separatamente.

LED light source included. Integrated 220-240V ON/OFF electrical power. Equipped with a length of neoprene cable and an IP68 2-way anti-condensation H₂O stop seal system. The device may be installed on any flooring with anchors. Anchoring plate for installation on flooring laid over concrete sold separately.

Mid - Power Led: 15,6W - 2x838 lm ≠ FIXT 2x603 lm - 2700K/CRI 80 - 220-240V / 15,6W - 2x872 lm ≠ FIXT 2x627 lm - 3000K/CRI 80 - 220-240V / 15,6W - 2x905 lm ≠ FIXT 2x651 lm - 4000K/CRI 80 - 220-240V

2700K

- Non Dimmable
- F015J22A001
- F015J22A006
- F015J22A012
- F015J22A018
- F015J22A030
- F015J22A033
- 1-10V
- F015J22B001
- F015J22B006
- F015J22B012
- F015J22B018
- F015J22B030
- F015J22B033
- Dali
- F015J22D001
- F015J22D006
- F015J22D012
- F015J22D018
- F015J22D030
- F015J22D033

3000K

- Non Dimmable
- F015J32A001
- F015J32A006
- F015J32A012
- F015J32A018
- F015J32A030
- F015J32A033
- 1-10V
- F015J32B001
- F015J32B006
- F015J32B012
- F015J32B018
- F015J32B030
- F015J32B033
- Dali
- F015J32D001
- F015J32D006
- F015J32D012
- F015J32D018
- F015J32D030
- F015J32D033

4000K

- Non Dimmable
- F015J42A001
- F015J42A006
- F015J42A012
- F015J42A018
- F015J42A030
- F015J42A033
- 1-10V
- F015J42B001
- F015J42B006
- F015J42B012
- F015J42B018
- F015J42B030
- F015J42B033
- Dali
- F015J42D001
- F015J42D006
- F015J42D012
- F015J42D018
- F015J42D030
- F015J42D033

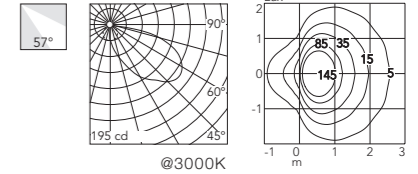

Mile Bollard 2 900 Mono

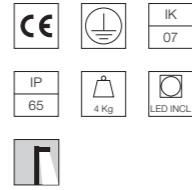
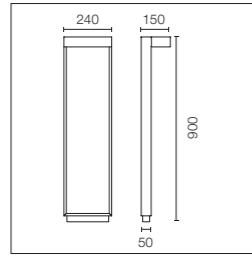

Sorgente luminosa a LED inclusa. Alimentazione elettrica 220-240V ON/OFF e dimmerabile 1-10V e DALI integrata. Dotato di uno spezzone di cavo uscente in neoprene e un sistema di giunzione IP68 H₂O Stop anti-condensa a 2 vie. L'apparecchio è installabile su qualsiasi pavimento per mezzo di tasselli. Piastra di ancoraggio per l'installazione su pavimentazione da gettare con plinto di cemento da ordinare separatamente.

LED light source included. Integrated 220-240V ON/OFF and 1-10V or DALI dimmable electrical power. Equipped with a length of neoprene cable and an IP68 2-way anti-condensation H₂O stop seal system. The device may be installed on any flooring with anchors. Anchoring plate for installation on flooring laid over concrete sold separately.

Mid - Power Led: 7,8W - 838 lm ≠ FIXT 603 lm - 2700K/CRI 80 - 220-240V / 7,8W - 872 lm ≠ FIXT 627 lm - 3000K/CRI 80 - 220-240V / 7,8W - 905 lm ≠ FIXT 651 lm - 4000K/CRI 80 - 220-240V

2700K

- Non Dimmable
- F015K21A001
 - F015K21A006
 - F015K21A012
 - F015K21A018
 - F015K21A030
 - F015K21A033
- 1-10V
- F015K21B001
 - F015K21B006
 - F015K21B012
 - F015K21B018
 - F015K21B030
 - F015K21B033
- Dali
- F015K21D001
 - F015K21D006
 - F015K21D012
 - F015K21D018
 - F015K21D030
 - F015K21D033

3000K

- Non Dimmable
- F015K31A001
 - F015K31A006
 - F015K31A012
 - F015K31A018
 - F015K31A030
 - F015K31A033
- 1-10V
- F015K31B001
 - F015K31B006
 - F015K31B012
 - F015K31B018
 - F015K31B030
 - F015K31B033
- Dali
- F015K31D001
 - F015K31D006
 - F015K31D012
 - F015K31D018
 - F015K31D030
 - F015K31D033

4000K

- Non Dimmable
- F015K41A001
 - F015K41A006
 - F015K41A012
 - F015K41A018
 - F015K41A030
 - F015K41A033
- 1-10V
- F015K41B001
 - F015K41B006
 - F015K41B012
 - F015K41B018
 - F015K41B030
 - F015K41B033
- Dali
- F015K41D001
 - F015K41D006
 - F015K41D012
 - F015K41D018
 - F015K41D030
 - F015K41D033

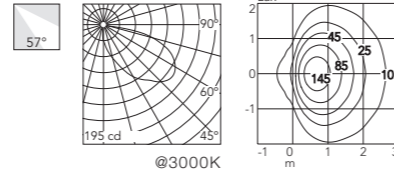

Mile Bollard 2 900 Double

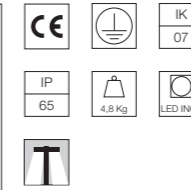
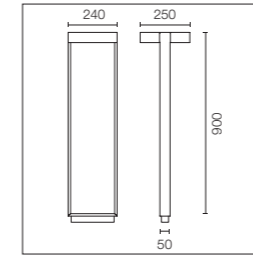

Sorgente luminosa a LED inclusa. Alimentazione elettrica 220-240V ON/OFF E DIMMERABILE 1-10V E DALI integrata. Dotato di uno spezzone di cavo uscente in neoprene e un sistema di giunzione IP68 H₂O Stop anti-condensa a 2 vie. L'apparecchio è installabile su qualsiasi pavimento per mezzo di tasselli. Piastra di ancoraggio per l'installazione su pavimentazione da gettare con plinto di cemento da ordinare separatamente.

LED light source included. Integrated 220-240V ON/OFF electrical power. Equipped with a length of neoprene cable and an IP68 2-way anti-condensation H₂O stop seal system. The device may be installed on any flooring with anchors. Anchoring plate for installation on flooring laid over concrete sold separately.

Mid - Power Led: 15,6W - 2x838 lm ≠ FIXT 2x603 lm - 2700K/CRI 80 - 220-240V / 15,6W - 2x872 lm ≠ FIXT 2x627 lm - 3000K/CRI 80 - 220-240V / 15,6W - 2x905 lm ≠ FIXT 2x651 lm - 4000K/CRI 80 - 220-240V

2700K

- Non Dimmable
- F015K22A001
 - F015K22A006
 - F015K22A012
 - F015K22A018
 - F015K22A030
 - F015K22A033
- 1-10V
- F015K22B001
 - F015K22B006
 - F015K22B012
 - F015K22B018
 - F015K22B030
 - F015K22B033
- Dali
- F015K22D001
 - F015K22D006
 - F015K22D012
 - F015K22D018
 - F015K22D030
 - F015K22D033

3000K

- Non Dimmable
- F015K32A001
 - F015K32A006
 - F015K32A012
 - F015K32A018
 - F015K32A030
 - F015K32A033
- 1-10V
- F015K32B001
 - F015K32B006
 - F015K32B012
 - F015K32B018
 - F015K32B030
 - F015K32B033
- Dali
- F015K32D001
 - F015K32D006
 - F015K32D012
 - F015K32D018
 - F015K32D030
 - F015K32D033

4000K

- Non Dimmable
- F015K42A001
 - F015K42A006
 - F015K42A012
 - F015K42A018
 - F015K42A030
 - F015K42A033
- 1-10V
- F015K42B001
 - F015K42B006
 - F015K42B012
 - F015K42B018
 - F015K42B030
 - F015K42B033
- Dali
- F015K42D001
 - F015K42D006
 - F015K42D012
 - F015K42D018
 - F015K42D030
 - F015K42D033

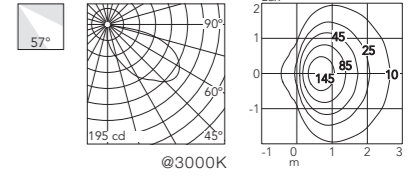

Pointbreak Bollard: Accessori / Accessories

Piastra tirafondi.

Base plate with bolt.

Bollard 1
F015Z000000



Piastra tirafondi.

Base plate with bolt.

Bollard 2
F015Z010000



Dispositivo di protezione per il sovraccarico. 275 Vac. Corrente massima di scarica 10KA (8/29us). Massima corrente operativa 5A. Adatto per la connessione in serie. IP66.

Surge protection device. 275Vac. Maximum discharge current 10KA (8/20us). Maximum operating current 5A. Suitable for series connection. IP66.

F990E00A000

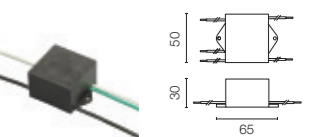

Mile Path 1

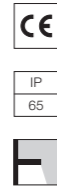
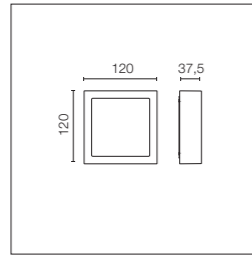

Sorgente luminosa a LED inclusa. Alimentazione elettrica 220-240V ON/OFF integrata.
Dotato di doppio passacavo per collegamento entra-esce. Staffa di fissaggio inclusa.

LED light source included. Integrated 220-240 V ON/OFF electrical power.
Equipped with double cable gland for inlet and outlet connection. Fixing bracket included.

Mid - Power Led: 3,7W - 422 lm ≠ FIXT 100 lm - 2700K/CRI>80 - 220-240V / 3,7W - 439 lm ≠ FIXT 104 lm - 3000K/CRI>80 - 220-240V / 3,7W - 456 lm ≠ FIXT 108 lm - 4000/CRI>80 - 220-240V

2700K

- F015L20A000
- F015L20A001
- F015L20A006
- F015L20A012
- F015L20A018
- F015L20A030
- F015L20A033

3000K

- F015L30A000
- F015L30A001
- F015L30A006
- F015L30A012
- F015L30A018
- F015L30A030
- F015L30A033

4000K

- F015L40A000
- F015L40A001
- F015L40A006
- F015L40A012
- F015L40A018
- F015L40A030
- F015L40A033

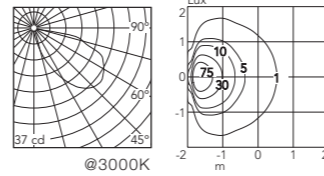

Mile Path 2

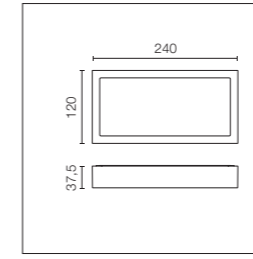

Sorgente luminosa a LED inclusa. Alimentazione elettrica 220-240V ON/OFF integrata e dimmabile 1-10V o DALI integrata.
Dotata di passacavo per collegamento di sicurezza a tenuta IP. Staffa di fissaggio inclusa.

LED light source included. Integrated 220-240V ON/OFF and 1-10V/DALI dimmable electrical power.
Equipped with a cable gland for safety connection with IP tightness. Fixing bracket included.

Mid - Power Led: 7,6W - 818 lm≠ FIXT 172 lm - 2700K/CRI>80 - 220-240V / 7,6W - 850 lm ≠ FIXT 179 lm - 3000K/CRI>80 - 220-240V / 7,6W - 883 lm ≠ FIXT 186 lm - 4000/CRI>80 - 220-240V

2700K

Non Dimmable

- F015M20A000
- F015M20A001
- F015M20A006
- F015M20A012
- F015M20A018
- F015M20A030
- F015M20A033
- 1-10V
- F015M20B000
- F015M20B001
- F015M20B006
- F015M20B012
- F015M20B018
- F015M20B030
- F015M20B033

Dali

- F015M20D000
- F015M20D001
- F015M20D006
- F015M20D012
- F015M20D018
- F015M20D030
- F015M20D033

3000K

Non Dimmable

- F015M30A000
- F015M30A001
- F015M30A006
- F015M30A012
- F015M30A018
- F015M30A030
- F015M30A033
- 1-10V
- F015M30B000
- F015M30B001
- F015M30B006
- F015M30B012
- F015M30B018
- F015M30B030
- F015M30B033

Dali

- F015M30D000
- F015M30D001
- F015M30D006
- F015M30D012
- F015M30D018
- F015M30D030
- F015M30D033

4000K

Non Dimmable

- F015M40A000
- F015M40A001
- F015M40A006
- F015M40A012
- F015M40A018
- F015M40A030
- F015M40A033
- 1-10V
- F015M40B000
- F015M40B001
- F015M40B006
- F015M40B012
- F015M40B018
- F015M40B030
- F015M40B033

Dali

- F015M40D000
- F015M40D001
- F015M40D006
- F015M40D012
- F015M40D018
- F015M40D030
- F015M40D033

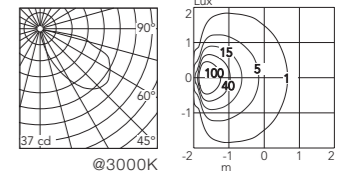

Mile Wall 1 Asymmetric Up

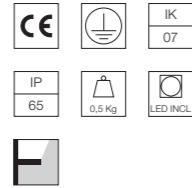
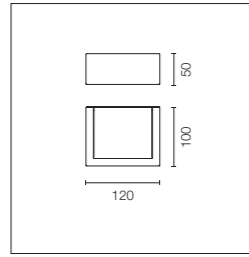

Sorgente luminosa a LED inclusa. Alimentazione elettrica 220-240V ON/OFF integrata. Dotato di doppio passacavo per collegamento entra-esci.

LED light source included. Integrated 220-240V ON/OFF electrical power. Equipped with double cable gland for electrical connection.

Mid - Power Led: 4,9W - 427 lm ≠ FIXT 283 lm - 2700K/CRI 80 - 220-240V / 4,9W - 445 lm ≠ FIXT 294 lm - 3000K/CRI 80 - 220-240V / 4,9W - 462 lm ≠ FIXT 305 lm - 4000K/CRI 80 - 220-240V

2700K

- F015A21A000
- F015A21A001
- F015A21A006
- F015A21A012
- F015A21A018
- F015A21A030
- F015A21A033

3000K

- F015A31A000
- F015A31A001
- F015A31A006
- F015A31A012
- F015A31A018
- F015A31A030
- F015A31A033

4000K

- F015A41A000
- F015A41A001
- F015A41A006
- F015A41A012
- F015A41A018
- F015A41A030
- F015A41A033

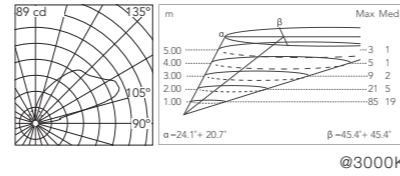

Mile Wall 1 Washer Up

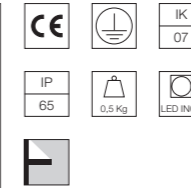
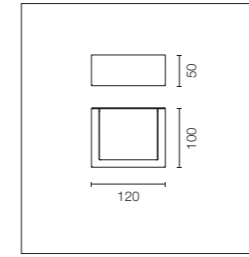

Sorgente luminosa a LED inclusa. Alimentazione elettrica 220-240V ON/OFF integrata. Dotato di doppio passacavo per collegamento entra-esci.

LED light source included. Integrated 220-240V ON/OFF electrical power. Equipped with double cable gland for electrical connection.

Mid - Power Led: 4,9W - 427 lm ≠ FIXT 291 lm - 2700K/CRI 80 - 220-240V / 4,9W - 445 lm ≠ FIXT 303 lm - 3000K/CRI 80 - 220-240V / 4,9W - 462 lm ≠ FIXT 314 lm - 4000K/CRI 80 - 220-240V

2700K

- F015B21A000
- F015B21A001
- F015B21A006
- F015B21A012
- F015B21A018
- F015B21A030
- F015B21A033

3000K

- F015B31A000
- F015B31A001
- F015B31A006
- F015B31A012
- F015B31A018
- F015B31A030
- F015B31A033

4000K

- F015B41A000
- F015B41A001
- F015B41A006
- F015B41A012
- F015B41A018
- F015B41A030
- F015B41A033

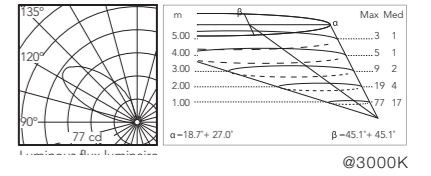

Mile Wall 1 Asymmetric Down

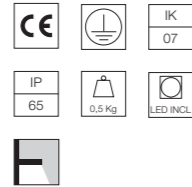
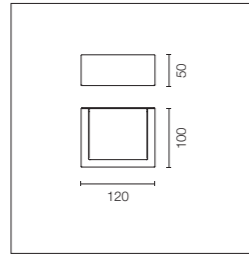

Sorgente luminosa a LED inclusa. Alimentazione elettrica 220-240V ON/OFF integrata. Dotato di doppio passacavo per collegamento entra-esci.

LED light source included. Integrated 220-240V ON/OFF electrical power. Equipped with double cable gland for electrical connection.

Mid - Power Led: 4,9W - 427 lm ≠ FIXT 283 lm - 2700K/CRI 80 - 220-240V / 4,9W - 445 lm ≠ FIXT 294 lm - 3000K/CRI 80 - 220-240V / 4,9W - 462 lm ≠ FIXT 305 lm - 4000K/CRI 80 - 220-240V

2700K

- F015A22A000
- F015A22A001
- F015A22A006
- F015A22A012
- F015A22A018
- F015A22A030
- F015A22A033

3000K

- F015A32A000
- F015A32A001
- F015A32A006
- F015A32A012
- F015A32A018
- F015A32A030
- F015A32A033

4000K

- F015A42A000
- F015A42A001
- F015A42A006
- F015A42A012
- F015A42A018
- F015A42A030
- F015A42A033

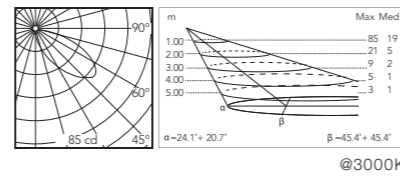

Mile Wall 1 Washer Down

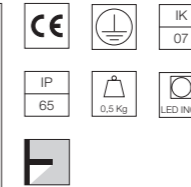
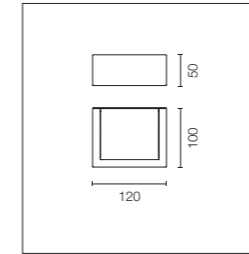

Sorgente luminosa a LED inclusa. Alimentazione elettrica 220-240V ON/OFF integrata. Dotato di doppio passacavo per collegamento entra-esci.

LED light source included. Integrated 220-240V ON/OFF electrical power. Equipped with double cable gland for electrical connection.

Mid - Power Led: 4,9W - 427 lm ≠ FIXT 291 lm - 2700K/CRI 80 - 220-240V / 4,9W - 445 lm ≠ FIXT 303 lm - 3000K/CRI 80 - 220-240V / 4,9W - 462 lm ≠ FIXT 314 lm - 4000K/CRI 80 - 220-240V

2700K

- F015B22A000
- F015B22A001
- F015B22A006
- F015B22A012
- F015B22A018
- F015B22A030
- F015B22A033

3000K

- F015B32A000
- F015B32A001
- F015B32A006
- F015B32A012
- F015B32A018
- F015B32A030
- F015B32A033

4000K

- F015B42A000
- F015B42A001
- F015B42A006
- F015B42A012
- F015B42A018
- F015B42A030
- F015B42A033

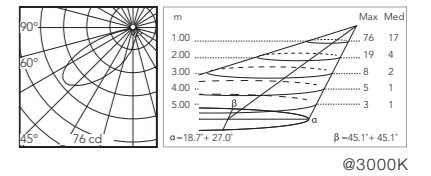

Mile Wall 1 Asymmetric Up & Down

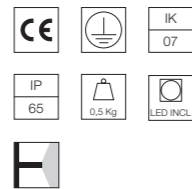
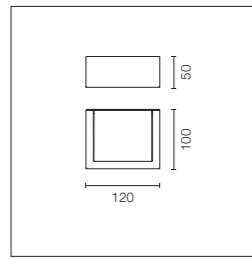

Sorgente luminosa a LED inclusa. Alimentazione elettrica 220-240V ON/OFF integrata. Dotato di doppio passacavo per collegamento entra-esce.

LED light source included. Integrated 220-240V ON/OFF electrical power. Equipped with double cable gland for electrical connection.

Mid - Power Led: 8,1W - 2x427 lm ≠ FIXT 2x291 lm - 2700K/CRI 80 - 220-240V / 8,1W - 2x445 lm ≠ FIXT 2x303 lm - 3000K/CRI 80 - 220-240V / 8,1W - 2x462 lm ≠ FIXT 2x314 lm - 4000K/CRI 80 - 220-240V

2700K

- F015A23A000
- F015A23A001
- F015A23A006
- F015A23A012
- F015A23A018
- F015A23A030
- F015A23A033

3000K

- F015A33A000
- F015A33A001
- F015A33A006
- F015A33A012
- F015A33A018
- F015A33A030
- F015A33A033

4000K

- F015A43A000
- F015A43A001
- F015A43A006
- F015A43A012
- F015A43A018
- F015A43A030
- F015A43A033

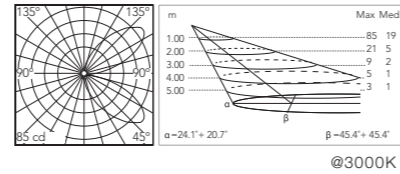

Mile Wall 1 Washer Down + Asymmetric Up

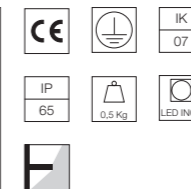
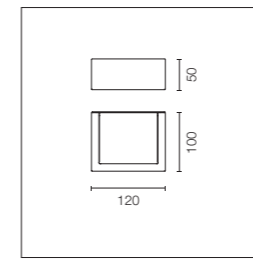

Sorgente luminosa a LED inclusa. Alimentazione elettrica 220-240V ON/OFF integrata. Dotato di doppio passacavo per collegamento entra-esce.

LED light source included. Integrated 220-240V ON/OFF electrical power. Equipped with double cable gland for electrical connection.

Mid - Power Led: 8,1W - 2x427 lm ≠ FIXT 291+283 lm - 2700K/CRI 80 - 220-240V / 8,1W - 2x445 lm ≠ FIXT 303+294 lm - 3000K/CRI 80 - 220-240V / 8,1W - 2x462 lm ≠ FIXT 314+305 lm - 4000K/CRI 80 - 220-240V

2700K

- F015C24A000
- F015C24A001
- F015C24A006
- F015C24A012
- F015C24A018
- F015C24A030
- F015C24A033

3000K

- F015C34A000
- F015C34A001
- F015C34A006
- F015C34A012
- F015C34A018
- F015C34A030
- F015C34A033

4000K

- F015C44A000
- F015C44A001
- F015C44A006
- F015C44A012
- F015C44A018
- F015C44A030
- F015C44A033

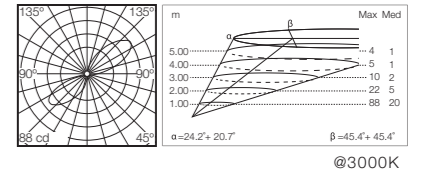

Mile Wall 1 Washer Up & Down

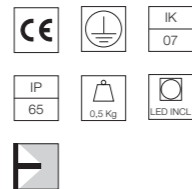
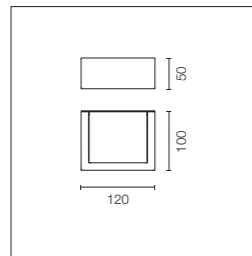

Sorgente luminosa a LED inclusa. Alimentazione elettrica 220-240V ON/OFF integrata. Dotato di doppio passacavo per collegamento entra-esce.

LED light source included. Integrated 220-240V ON/OFF electrical power. Equipped with double cable gland for electrical connection.

Mid - Power Led: 8,1W - 2x427 lm ≠ FIXT 2x291 lm - 2700K/CRI 80 - 220-240V / 8,1W - 2x445 lm ≠ FIXT 2x303 lm - 3000K/CRI 80 - 220-240V / 8,1W - 2x462 lm ≠ FIXT 2x314 lm - 4000K/CRI 80 - 220-240V

2700K

- F015B23A000
- F015B23A001
- F015B23A006
- F015B23A012
- F015B23A018
- F015B23A030
- F015B23A033

3000K

- F015B33A000
- F015B33A001
- F015B33A006
- F015B33A012
- F015B33A018
- F015B33A030
- F015B33A033

4000K

- F015B43A000
- F015B43A001
- F015B43A006
- F015B43A012
- F015B43A018
- F015B43A030
- F015B43A033

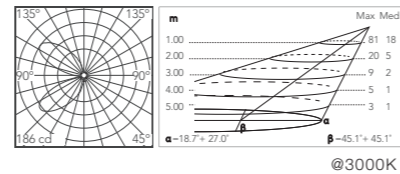

Mile Wall 2 Asymmetric Up

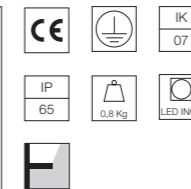
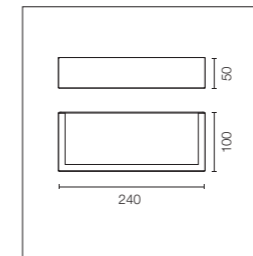

Sorgente luminosa a LED inclusa. Alimentazione elettrica 220-240V ON/OFF e dimmabile 1-10V o DALI integrata. Dotato di doppio passacavo per collegamento entra-esce.

LED light source included. Integrated 220-240V ON/OFF and 1-10V or DALI dimmable electrical power. Equipped with double cable gland for electrical connection.

Mid - Power Led: 7,8W - 838 lm ≠ FIXT 603 lm - 2700K/CRI 80 - 220-240V / 7,8W - 872 lm ≠ FIXT 627 lm - 3000K/CRI 80 - 220-240V / 7,8W - 905 lm ≠ FIXT 651 lm - 4000K/CRI 80 - 220-240V

2700K

- Non Dimmable
- F015D21A000
 - F015D21A001
 - F015D21A006
 - F015D21A012
 - F015D21A018
 - F015D21A030
 - F015D21A033
 - 1-10V
 - F015D21B000
 - F015D21B001
 - F015D21B006
 - F015D21B012
 - F015D21B018
 - F015D21B030
 - F015D21B033
 - Dali
 - F015D21D000
 - F015D21D001
 - F015D21D006
 - F015D21D012
 - F015D21D018
 - F015D21D030
 - F015D21D033

3000K

- Non Dimmable
- F015D31A000
 - F015D31A001
 - F015D31A006
 - F015D31A012
 - F015D31A018
 - F015D31A030
 - F015D31A033
 - 1-10V
 - F015D31B000
 - F015D31B001
 - F015D31B006
 - F015D31B012
 - F015D31B018
 - F015D31B030
 - F015D31B033
 - Dali
 - F015D31D000
 - F015D31D001
 - F015D31D006
 - F015D31D012
 - F015D31D018
 - F015D31D030
 - F015D31D033

4000K

- Non Dimmable
- F015D41A000
 - F015D41A001
 - F015D41A006
 - F015D41A012
 - F015D41A018
 - F015D41A030
 - F015D41A033
 - 1-10V
 - F015D41B000
 - F015D41B001
 - F015D41B006
 - F015D41B012
 - F015D41B018
 - F015D41B030
 - F015D41B033
 - Dali
 - F015D41D000
 - F015D41D001
 - F015D41D006
 - F015D41D012
 - F015D41D018
 - F015D41D030
 - F015D41D033

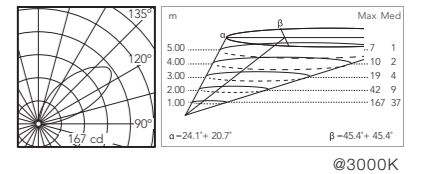

Mile Wall 2 Asymmetric Down

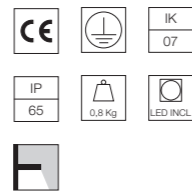
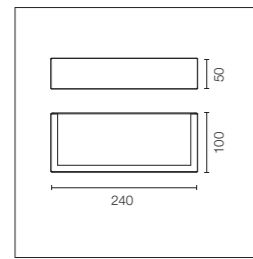
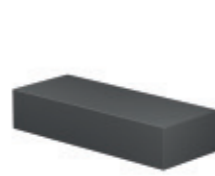

Sorgente luminosa a LED inclusa. Alimentazione elettrica 220-240V ON/OFF e dimmabile 1-10V o DALI integrata. Dotato di doppio passacavo per collegamento entra-esce.

LED light source included. Integrated 220-240V ON/OFF and 1-10V or DALI dimmable electrical power. Equipped with double cable gland for electrical connection.

Mid - Power Led: 7,8W - 838 lm ≠ FIXT 603 lm - 2700K/CRI 80 - 220-240V / 7,8W - 872 lm ≠ FIXT 627 lm - 3000K/CRI 80 - 220-240V / 7,8W - 905 lm ≠ FIXT 651 lm - 4000K/CRI 80 - 220-240V

2700K

Non Dimmable

- F015D22A000
- F015D22A001
- F015D22A006
- F015D22A012
- F015D22A018
- F015D22A030
- F015D22A033

1-10V

- F015D22B000
- F015D22B001
- F015D22B006
- F015D22B012
- F015D22B018
- F015D22B030
- F015D22B033

Dali

- F015D22D000
- F015D22D001
- F015D22D006
- F015D22D012
- F015D22D018
- F015D22D030
- F015D22D033

3000K

Non Dimmable

- F015D32A000
- F015D32A001
- F015D32A006
- F015D32A012
- F015D32A018
- F015D32A030
- F015D32A033

1-10V

- F015D32B000
- F015D32B001
- F015D32B006
- F015D32B012
- F015D32B018
- F015D32B030
- F015D32B033

Dali

- F015D32D000
- F015D32D001
- F015D32D006
- F015D32D012
- F015D32D018
- F015D32D030
- F015D32D033

4000K

Non Dimmable

- F015D42A000
- F015D42A001
- F015D42A006
- F015D42A012
- F015D42A018
- F015D42A030
- F015D42A033

1-10V

- F015D42B000
- F015D42B001
- F015D42B006
- F015D42B012
- F015D42B018
- F015D42B030
- F015D42B033

Dali

- F015D42D000
- F015D42D001
- F015D42D006
- F015D42D012
- F015D42D018
- F015D42D030
- F015D42D033

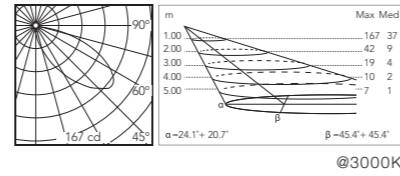

Mile Wall 2 Washer Up

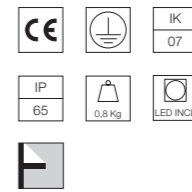
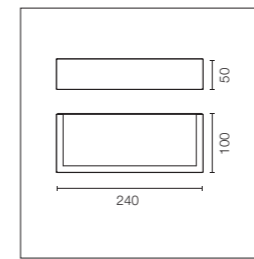

Sorgente luminosa a LED inclusa. Alimentazione elettrica 220-240V ON/OFF e dimmabile 1-10V o DALI integrata. Dotato di doppio passacavo per collegamento entra-esce.

LED light source included. Integrated 220-240V ON/OFF and 1-10V or DALI dimmable electrical power. Equipped with double cable gland for electrical connection.

Mid - Power Led: 6,4W - 661 lm ≠ FIXT 453 lm - 2700K/CRI 80 - 220-240V / 6,4W - 714 lm ≠ FIXT 471 lm - 3000K/CRI 80 - 220-240V / 6,4W - 714 lm ≠ FIXT 489 lm - 4000K/CRI 80 - 220-240V

2700K

Non Dimmable

- F015E21A000
- F015E21A001
- F015E21A006
- F015E21A012
- F015E21A018
- F015E21A030
- F015E21A033

1-10V

- F015E21B000
- F015E21B001
- F015E21B006
- F015E21B012
- F015E21B018
- F015E21B030
- F015E21B033

Dali

- F015E21D000
- F015E21D001
- F015E21D006
- F015E21D012
- F015E21D018
- F015E21D030
- F015E21D033

3000K

Non Dimmable

- F015E31A000
- F015E31A001
- F015E31A006
- F015E31A012
- F015E31A018
- F015E31A030
- F015E31A033

1-10V

- F015E31B000
- F015E31B001
- F015E31B006
- F015E31B012
- F015E31B018
- F015E31B030
- F015E31B033

Dali

- F015E31D000
- F015E31D001
- F015E31D006
- F015E31D012
- F015E31D018
- F015E31D030
- F015E31D033

4000K

Non Dimmable

- F015E41A000
- F015E41A001
- F015E41A006
- F015E41A012
- F015E41A018
- F015E41A030
- F015E41A033

1-10V

- F015E41B000
- F015E41B001
- F015E41B006
- F015E41B012
- F015E41B018
- F015E41B030
- F015E41B033

Dali

- F015E41D000
- F015E41D001
- F015E41D006
- F015E41D012
- F015E41D018
- F015E41D030
- F015E41D033

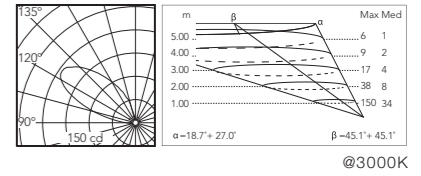

Mile Wall 2 Washer Down

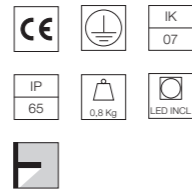
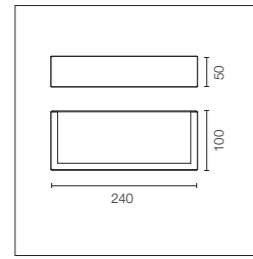

Sorgente luminosa a LED inclusa. Alimentazione elettrica 220-240V ON/OFF e dimmabile 1-10V o DALI integrata. Dotato di doppio passacavo per collegamento entra-esce.

LED light source included. Integrated 220-240V ON/OFF and 1-10V or DALI dimmable electrical power. Equipped with double cable gland for electrical connection.

Mid - Power Led: 6,4W - 661 lm ≠ FIXT 453 lm - 2700K/CRI 80 - 220-240V / 6,4W - 714 lm ≠ FIXT 471 lm - 3000K/CRI 80 - 220-240V / 6,4W - 714 lm ≠ FIXT 489 lm - 4000K/CRI 80 - 220-240V

2700K

Non Dimmable

- F015E22A000
- F015E22A001
- F015E22A006
- F015E22A012
- F015E22A018
- F015E22A030
- F015E22A033

1-10V

- F015E22B000
- F015E22B001
- F015E22B006
- F015E22B012
- F015E22B018
- F015E22B030
- F015E22B033

Dali

- F015E22D000
- F015E22D001
- F015E22D006
- F015E22D012
- F015E22D018
- F015E22D030
- F015E22D033

3000K

Non Dimmable

- F015E32A000
- F015E32A001
- F015E32A006
- F015E32A012
- F015E32A018
- F015E32A030
- F015E32A033

1-10V

- F015E32B000
- F015E32B001
- F015E32B006
- F015E32B012
- F015E32B018
- F015E32B030
- F015E32B033

Dali

- F015E32D000
- F015E32D001
- F015E32D006
- F015E32D012
- F015E32D018
- F015E32D030
- F015E32D033

4000K

Non Dimmable

- F015E42A000
- F015E42A001
- F015E42A006
- F015E42A012
- F015E42A018
- F015E42A030
- F015E42A033

1-10V

- F015E42B000
- F015E42B001
- F015E42B006
- F015E42B012
- F015E42B018
- F015E42B030
- F015E42B033

Dali

- F015E42D000
- F015E42D001
- F015E42D006
- F015E42D012
- F015E42D018
- F015E42D030
- F015E42D033

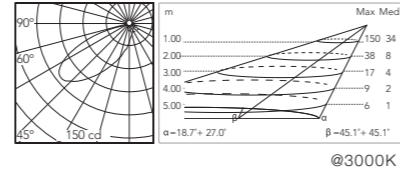

Mile Wall 2 Asymmetric Up & Down

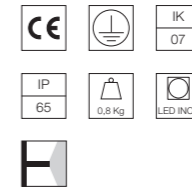
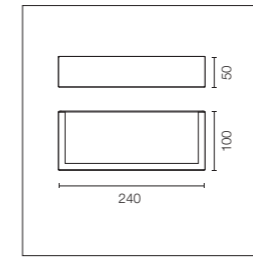
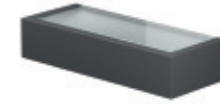

Sorgente luminosa a LED inclusa. Alimentazione elettrica 220-240V ON/OFF e dimmabile 1-10V o DALI integrata. Dotato di doppio passacavo per collegamento entra-esce.

LED light source included. Integrated 220-240V ON/OFF and 1-10V or DALI dimmable electrical power. Equipped with double cable gland for electrical connection.

Mid - Power Led: 13,5W - 2x838 lm ≠ FIXT 2x603 lm - 2700K/CRI 80 - 220-240V / 13,5W - 2x872 lm ≠ FIXT 2x627 lm - 3000K/CRI 80 - 220-240V / 13,5W - 2x905 lm ≠ FIXT 2x651 lm - 4000K/CRI 80 - 220-240V

2700K

Non Dimmable

- F015D23A000
- F015D23A001
- F015D23A006
- F015D23A012
- F015D23A018
- F015D23A030
- F015D23A033

1-10V

- F015D23B000
- F015D23B001
- F015D23B006
- F015D23B012
- F015D23B018
- F015D23B030
- F015D23B033

Dali

- F015D23D000
- F015D23D001
- F015D23D006
- F015D23D012
- F015D23D018
- F015D23D030
- F015D23D033

3000K

Non Dimmable

- F015D33A000
- F015D33A001
- F015D33A006
- F015D33A012
- F015D33A018
- F015D33A030
- F015D33A033

1-10V

- F015D33B000
- F015D33B001
- F015D33B006
- F015D33B012
- F015D33B018
- F015D33B030
- F015D33B033

Dali

- F015D33D000
- F015D33D001
- F015D33D006
- F015D33D012
- F015D33D018
- F015D33D030
- F015D33D033

4000K

Non Dimmable

- F015D43A000
- F015D43A001
- F015D43A006
- F015D43A012
- F015D43A018
- F015D43A030
- F015D43A033

1-10V

- F015D43B000
- F015D43B001
- F015D43B006
- F015D43B012
- F015D43B018
- F015D43B030
- F015D43B033

Dali

- F015D43D000
- F015D43D001
- F015D43D006
- F015D43D012
- F015D43D018
- F015D43D030
- F015D43D033

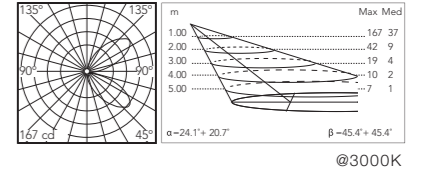

Mile Wall 2 Washer Up & Down

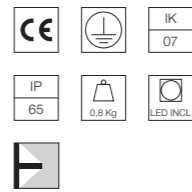
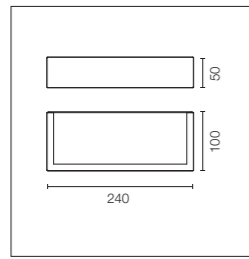
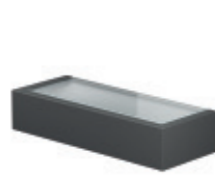

Sorgente luminosa a LED inclusa. Alimentazione elettrica 220-240V ON/OFF e dimmarabile 1-10V o DALI integrata. Dotato di doppio passacavo per collegamento entra-esce.

LED light source included. Integrated 220-240V ON/OFF and 1-10V or DALI dimmable electrical power. Equipped with double cable gland for electrical connection.

Mid - Power Led: 10,5W - 2x661 lm ≠ FIXT 2x453 lm - 2700K/CRI 80 - 220-240V / 10,5W - 2x714 lm ≠ FIXT 2x471 lm - 3000K/CRI 80 - 220-240V / 10,5W - 2x714 lm ≠ FIXT 2x489 lm - 4000K/CRI 80 - 220-240V

2700K

Non Dimmable

- F015E23A000
- F015E23A001
- F015E23A006
- F015E23A012
- F015E23A018
- F015E23A030
- F015E23A033

1-10V

- F015E23B000
- F015E23B001
- F015E23B006
- F015E23B012
- F015E23B018
- F015E23B030
- F015E23B033

Dali

- F015E23D000
- F015E23D001
- F015E23D006
- F015E23D012
- F015E23D018
- F015E23D030
- F015E23D033

3000K

Non Dimmable

- F015E33A000
- F015E33A001
- F015E33A006
- F015E33A012
- F015E33A018
- F015E33A030
- F015E33A033

1-10V

- F015E33B000
- F015E33B001
- F015E33B006
- F015E33B012
- F015E33B018
- F015E33B030
- F015E33B033

Dali

- F015E33D000
- F015E33D001
- F015E33D006
- F015E33D012
- F015E33D018
- F015E33D030
- F015E33D033

4000K

Non Dimmable

- F015E43A000
- F015E43A001
- F015E43A006
- F015E43A012
- F015E43A018
- F015E43A030
- F015E43A033

1-10V

- F015E43B000
- F015E43B001
- F015E43B006
- F015E43B012
- F015E43B018
- F015E43B030
- F015E43B033

Dali

- F015E43D000
- F015E43D001
- F015E43D006
- F015E43D012
- F015E43D018
- F015E43D030
- F015E43D033

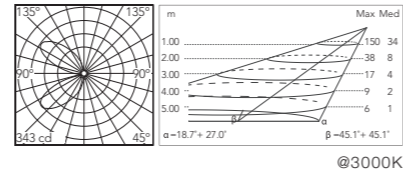

Mile Wall 2 Washer Down + Asymmetric Up

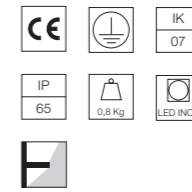
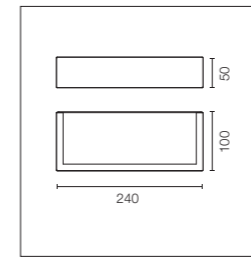

Sorgente luminosa a LED inclusa. Alimentazione elettrica 220-240V ON/OFF e dimmarabile 1-10V o DALI integrata. Dotato di doppio passacavo per collegamento entra-esce.

LED light source included. Integrated 220-240V ON/OFF and 1-10V or DALI dimmable electrical power. Equipped with double cable gland for electrical connection.

Mid - Power Led: 12W - 661+838 lm ≠ FIXT 453+603 lm - 2700K/CRI 80 - 220-240V / 12W - 2714+872 lm ≠ FIXT 471+627 lm - 3000K/CRI 80 - 220-240V / 12W - 714+905 lm ≠ FIXT 489+651 lm - 4000K/CRI 80 - 220-240V

2700K

Non Dimmable

- F015F24A000
- F015F24A001
- F015F24A006
- F015F24A012
- F015F24A018
- F015F24A030
- F015F24A033

1-10V

- F015F24B000
- F015F24B001
- F015F24B006
- F015F24B012
- F015F24B018
- F015F24B030
- F015F24B033

Dali

- F015F24D000
- F015F24D001
- F015F24D006
- F015F24D012
- F015F24D018
- F015F24D030
- F015F24D033

3000K

Non Dimmable

- F015F34A000
- F015F34A001
- F015F34A006
- F015F34A012
- F015F34A018
- F015F34A030
- F015F34A033

1-10V

- F015F34B000
- F015F34B001
- F015F34B006
- F015F34B012
- F015F34B018
- F015F34B030
- F015F34B033

Dali

- F015F34D000
- F015F34D001
- F015F34D006
- F015F34D012
- F015F34D018
- F015F34D030
- F015F34D033

4000K

Non Dimmable

- F015F44A000
- F015F44A001
- F015F44A006
- F015F44A012
- F015F44A018
- F015F44A030
- F015F44A033

1-10V

- F015F44B000
- F015F44B001
- F015F44B006
- F015F44B012
- F015F44B018
- F015F44B030
- F015F44B033

Dali

- F015F44D000
- F015F44D001
- F015F44D006
- F015F44D012
- F015F44D018
- F015F44D030
- F015F44D033

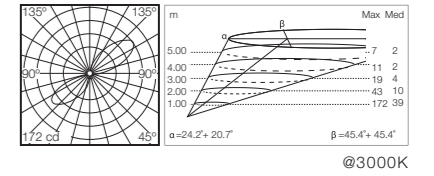

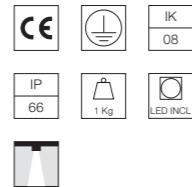
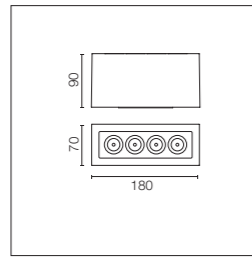

Sorgente luminosa a LED inclusa. Alimentazione elettrica 220-240V ON/OFF integrata e dimmabile 1-10V o DALI integrata. Dotato di doppio passacavo per collegamento entra-esce. Staffa di fissaggio inclusa.

LED light source included. Integrated 220-240V ON/OFF and 1-10V/DALI dimmable electrical power. Equipped with double cable gland for inlet and outlet connection. Fixing bracket included.

Mid - Power Led: 11W - 994 lm ≠ *FIXT 736 lm - 2700K/CRI>80 - 220-240V / 11W - 1030 lm ≠ *FIXT 759 lm - 3000K/CRI>80 - 220-240V / 11W - 1067 lm ≠ *FIXT 791 lm - 4000K/CRI>80 - 220-240V
*Fixt lm = Spot Optic

Optic Spot

2700K

- Non Dimmable
- F030A21A000
- F030A21A001
- F030A21A006
- F030A21A012
- F030A21A018
- F030A21A030
- F030A21A033
- 1-10V
- F030A21B000
- F030A21B001
- F030A21B006
- F030A21B012
- F030A21B018
- F030A21B030
- F030A21B033
- Dali
- F030A21D000
- F030A21D001
- F030A21D006
- F030A21D012
- F030A21D018
- F030A21D030
- F030A21D033

3000K

- Non Dimmable
- F030A31A000
- F030A31A001
- F030A31A006
- F030A31A012
- F030A31A018
- F030A31A030
- F030A31A033
- 1-10V
- F030A31B000
- F030A31B001
- F030A31B006
- F030A31B012
- F030A31B018
- F030A31B030
- F030A31B033
- Dali
- F030A31D000
- F030A31D001
- F030A31D006
- F030A31D012
- F030A31D018
- F030A31D030
- F030A31D033

4000K

- Non Dimmable
- F030A41A000
- F030A41A001
- F030A41A006
- F030A41A012
- F030A41A018
- F030A41A030
- F030A41A033
- 1-10V
- F030A41B000
- F030A41B001
- F030A41B006
- F030A41B012
- F030A41B018
- F030A41B030
- F030A41B033
- Dali
- F030A41D000
- F030A41D001
- F030A41D006
- F030A41D012
- F030A41D018
- F030A41D030
- F030A41D033

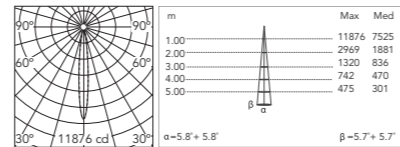

@3000K

Optic Medium

2700K

- Non Dimmable
- F030A22A000
- F030A22A001
- F030A22A006
- F030A22A012
- F030A22A018
- F030A22A030
- F030A22A033
- 1-10V
- F030A22B000
- F030A22B001
- F030A22B006
- F030A22B012
- F030A22B018
- F030A22B030
- F030A22B033
- Dali
- F030A22D000
- F030A22D001
- F030A22D006
- F030A22D012
- F030A22D018
- F030A22D030
- F030A22D033

3000K

- Non Dimmable
- F030A32A000
- F030A32A001
- F030A32A006
- F030A32A012
- F030A32A018
- F030A32A030
- F030A32A033
- 1-10V
- F030A32B000
- F030A32B001
- F030A32B006
- F030A32B012
- F030A32B018
- F030A32B030
- F030A32B033
- Dali
- F030A32D000
- F030A32D001
- F030A32D006
- F030A32D012
- F030A32D018
- F030A32D030
- F030A32D033

4000K

- Non Dimmable
- F030A42A000
- F030A42A001
- F030A42A006
- F030A42A012
- F030A42A018
- F030A42A030
- F030A42A033
- 1-10V
- F030A42B000
- F030A42B001
- F030A42B006
- F030A42B012
- F030A42B018
- F030A42B030
- F030A42B033
- Dali
- F030A42D000
- F030A42D001
- F030A42D006
- F030A42D012
- F030A42D018
- F030A42D030
- F030A42D033

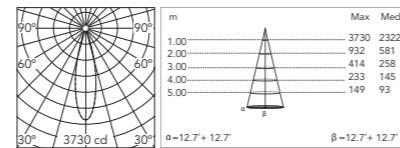

@3000K

Optic Flood

2700K

- Non Dimmable
- F030A23A000
- F030A23A001
- F030A23A006
- F030A23A012
- F030A23A018
- F030A23A030
- F030A23A033
- 1-10V
- F030A23B000
- F030A23B001
- F030A23B006
- F030A23B012
- F030A23B018
- F030A23B030
- F030A23B033
- Dali
- F030A23D000
- F030A23D001
- F030A23D006
- F030A23D012
- F030A23D018
- F030A23D030
- F030A23D033

3000K

- Non Dimmable
- F030A33A000
- F030A33A001
- F030A33A006
- F030A33A012
- F030A33A018
- F030A33A030
- F030A33A033
- 1-10V
- F030A33B000
- F030A33B001
- F030A33B006
- F030A33B012
- F030A33B018
- F030A33B030
- F030A33B033
- Dali
- F030A33D000
- F030A33D001
- F030A33D006
- F030A33D012
- F030A33D018
- F030A33D030
- F030A33D033

4000K

- Non Dimmable
- F030A43A000
- F030A43A001
- F030A43A006
- F030A43A012
- F030A43A018
- F030A43A030
- F030A43A033
- 1-10V
- F030A43B000
- F030A43B001
- F030A43B006
- F030A43B012
- F030A43B018
- F030A43B030
- F030A43B033
- Dali
- F030A43D000
- F030A43D001
- F030A43D006
- F030A43D012
- F030A43D018
- F030A43D030
- F030A43D033

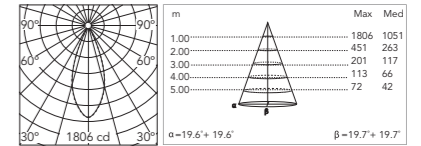

@3000K

Accessori per versioni non dimmable / Accessories for non-dimmable versions

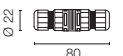
Sistema di giunzione IP68 H2O Stop anti-condensa a 2 vie 4 poli.	2 way terminal block 4 poles IP68 H2O Stop.	F990C00A000		
--	---	-------------	---	---

Sistema di giunzione IP68 H2O Stop anti-condensa a 3/4 vie 4 poli. (Ø5,5÷12mm cavo).	3/4 way terminal block 4 poles IP68 H2O Stop. (ø5,5÷12mm cable).	F990C010000		
--	--	-------------	---	--

Accessori per versioni Dimmerabili / Accessories for dimmable versions

Kit connettore 5 poli presa volante + spina EU IP68.	Connector kit 5-pole flying socket + EU plug IP68.	F990C080000		
--	--	-------------	---	--

Scatola di derivazione 5 poli 4 vie IP68 (cavi 6-14 mm).	4 way junction box 5 poles IP68 (6-14 mm cables).	F990C030000		
--	---	-------------	---	--

Mile Ceiling 2

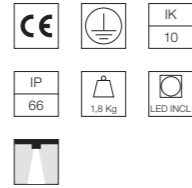
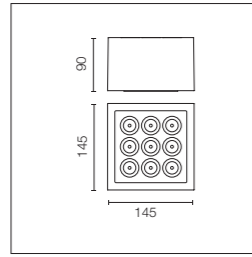

Sorgente luminosa a LED inclusa. Alimentazione elettrica 220-240V ON/OFF integrata e dimmabile 1-10V o DALI integrata. Dotato di doppio passacavo per collegamento entra-esci. Staffa di fissaggio inclusa.

LED light source included. Integrated 220-240V ON/OFF and 1-10V/DALI dimmable electrical power. Equipped with double cable gland for inlet and outlet connection. Fixing bracket included.

Mid - Power Led: 15W - 1677 lm ≠ *FIXT 1032 lm - 2700K/CRI>80 - 220-240V / 15W - 1739 lm ≠ *FIXT 1344 lm - 3000K/CRI>80 - 220-240V / 15W - 1800 lm ≠ *FIXT 1400 lm - 4000K/CRI>80 - 220-240V
*Fixt lm = Spot Optic

Optic Spot

2700K

- Non Dimmable
- F030C21A000
 - F030C21A001
 - F030C21A006
 - F030C21A012
 - F030C21A018
 - F030C21A030
 - F030C21A033
- 1-10V
- F030C21B000
 - F030C21B001
 - F030C21B006
 - F030C21B012
 - F030C21B018
 - F030C21B030
 - F030C21B033
- Dali
- F030C21D000
 - F030C21D001
 - F030C21D006
 - F030C21D012
 - F030C21D018
 - F030C21D030
 - F030C21D033

3000K

- Non Dimmable
- F030C31A000
 - F030C31A001
 - F030C31A006
 - F030C31A012
 - F030C31A018
 - F030C31A030
 - F030C31A033
- 1-10V
- F030C31B000
 - F030C31B001
 - F030C31B006
 - F030C31B012
 - F030C31B018
 - F030C31B030
 - F030C31B033
- Dali
- F030C31D000
 - F030C31D001
 - F030C31D006
 - F030C31D012
 - F030C31D018
 - F030C31D030
 - F030C31D033

4000K

- Non Dimmable
- F030C41A000
 - F030C41A001
 - F030C41A006
 - F030C41A012
 - F030C41A018
 - F030C41A030
 - F030C41A033
- 1-10V
- F030C41B000
 - F030C41B001
 - F030C41B006
 - F030C41B012
 - F030C41B018
 - F030C41B030
 - F030C41B033
- Dali
- F030C41D000
 - F030C41D001
 - F030C41D006
 - F030C41D012
 - F030C41D018
 - F030C41D030
 - F030C41D033

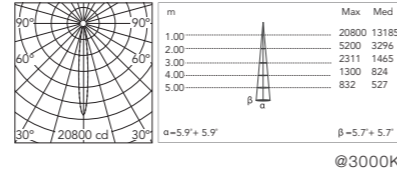

Optic Medium

2700K

- Non Dimmable
- F030C22A000
 - F030C22A001
 - F030C22A006
 - F030C22A012
 - F030C22A018
 - F030C22A030
 - F030C22A033
- 1-10V
- F030C22B000
 - F030C22B001
 - F030C22B006
 - F030C22B012
 - F030C22B018
 - F030C22B030
 - F030C22B033
- Dali
- F030C22D000
 - F030C22D001
 - F030C22D006
 - F030C22D012
 - F030C22D018
 - F030C22D030
 - F030C22D033

3000K

- Non Dimmable
- F030C32A000
 - F030C32A001
 - F030C32A006
 - F030C32A012
 - F030C32A018
 - F030C32A030
 - F030C32A033
- 1-10V
- F030C32B000
 - F030C32B001
 - F030C32B006
 - F030C32B012
 - F030C32B018
 - F030C32B030
 - F030C32B033
- Dali
- F030C32D000
 - F030C32D001
 - F030C32D006
 - F030C32D012
 - F030C32D018
 - F030C32D030
 - F030C32D033

4000K

- Non Dimmable
- F030C42A000
 - F030C42A001
 - F030C42A006
 - F030C42A012
 - F030C42A018
 - F030C42A030
 - F030C42A033
- 1-10V
- F030C42B000
 - F030C42B001
 - F030C42B006
 - F030C42B012
 - F030C42B018
 - F030C42B030
 - F030C42B033
- Dali
- F030C42D000
 - F030C42D001
 - F030C42D006
 - F030C42D012
 - F030C42D018
 - F030C42D030
 - F030C42D033

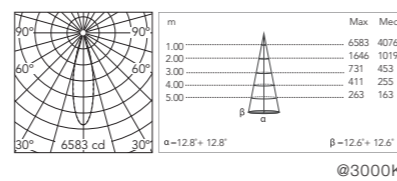

Optic Flood

2700K

- Non Dimmable
- F030C23A000
 - F030C23A001
 - F030C23A006
 - F030C23A012
 - F030C23A018
 - F030C23A030
 - F030C23A033
- 1-10V
- F030C23B000
 - F030C23B001
 - F030C23B006
 - F030C23B012
 - F030C23B018
 - F030C23B030
 - F030C23B033
- Dali
- F030C23D000
 - F030C23D001
 - F030C23D006
 - F030C23D012
 - F030C23D018
 - F030C23D030
 - F030C23D033

3000K

- Non Dimmable
- F030C33A000
 - F030C33A001
 - F030C33A006
 - F030C33A012
 - F030C33A018
 - F030C33A030
 - F030C33A033
- 1-10V
- F030C33B000
 - F030C33B001
 - F030C33B006
 - F030C33B012
 - F030C33B018
 - F030C33B030
 - F030C33B033
- Dali
- F030C33D000
 - F030C33D001
 - F030C33D006
 - F030C33D012
 - F030C33D018
 - F030C33D030
 - F030C33D033

4000K

- Non Dimmable
- F030C43A000
 - F030C43A001
 - F030C43A006
 - F030C43A012
 - F030C43A018
 - F030C43A030
 - F030C43A033
- 1-10V
- F030C43B000
 - F030C43B001
 - F030C43B006
 - F030C43B012
 - F030C43B018
 - F030C43B030
 - F030C43B033
- Dali
- F030C43D000
 - F030C43D001
 - F030C43D006
 - F030C43D012
 - F030C43D018
 - F030C43D030
 - F030C43D033

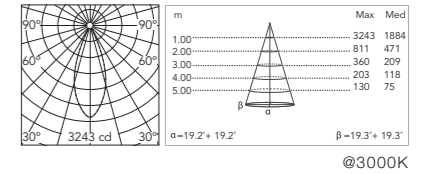

Accessori per versioni non dimmable / Accessories for non-dimmable versions

Sistema di giunzione IP68 H2O Stop anti-condensa a 2 vie 4 poli.

2 way terminal block 4 poles IP68 H2O Stop.

F990C00A000



Sistema di giunzione IP68 H2O Stop anti-condensa a 3/4 vie 4 poli. (Ø5,5÷12mm cavo).

3/4 way terminal block 4 poles IP68 H2O Stop. (ø5,5÷12mm cable).

F990C010000



Accessori per versioni Dimmerabili / Accessories for dimmable versions

Kit connettore 5 poli presa volante + spina EU IP68.

Connector kit 5-pole flying socket + EU plug IP68.

F990C080000



Scatola di derivazione 5 poli 4 vie IP68 (cavi 6-14 mm).

4 way junction box 5 poles IP68 (6-14 mm cables).

F990C030000



Mile Recessed 1

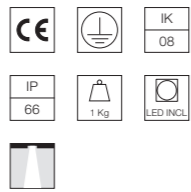
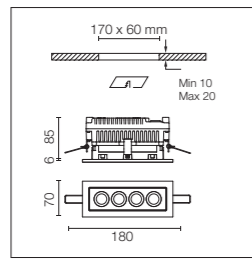

Sorgente luminosa a LED inclusa. Alimentazione elettrica 220-240V ON/OFF integrata e dimmabile 1-10V o DALI integrata. Dotato di spezzone di cavo uscente in neoprene e doppio passacavo per collegamento entra-esci. Molle di fissaggio per controsoffitto incluse. Cassaforma per soffitti in muratura da ordinare separatamente.

LED light source included. Integrated 220-240V ON/OFF and 1-10V/DALI dimmable electrical power. Equipped with neoprene cable outlet and double cable grommet for in/out connection. Ceiling mounting springs included. Box for brick roofing installation to be ordered separately.

Mid - Power Led: 11W - 994 lm ≠ *FIXT 736 lm - 2700K/CRI>80 - 220-240V / 11W - 1030 lm ≠ *FIXT 759 lm - 3000K/CRI>80 - 220-240V / 11W - 1067 lm ≠ *FIXT 791 lm - 4000K/CRI>80 - 220-240V
*Fixt lm = Spot Optic

Optic Spot

2700K

- Non Dimmable
- F030B21A000
 - F030B21A001
 - F030B21A006
 - F030B21A012
 - F030B21A018
 - F030B21A030
 - F030B21A033
- 1-10V
- F030B21B000
 - F030B21B001
 - F030B21B006
 - F030B21B012
 - F030B21B018
 - F030B21B030
 - F030B21B033
- Dali
- F030B21D000
 - F030B21D001
 - F030B21D006
 - F030B21D012
 - F030B21D018
 - F030B21D030
 - F030B21D033

3000K

- Non Dimmable
- F030B31A000
 - F030B31A001
 - F030B31A006
 - F030B31A012
 - F030B31A018
 - F030B31A030
 - F030B31A033
- 1-10V
- F030B31B000
 - F030B31B001
 - F030B31B006
 - F030B31B012
 - F030B31B018
 - F030B31B030
 - F030B31B033
- Dali
- F030B31D000
 - F030B31D001
 - F030B31D006
 - F030B31D012
 - F030B31D018
 - F030B31D030
 - F030B31D033

4000K

- Non Dimmable
- F030B41A000
 - F030B41A001
 - F030B41A006
 - F030B41A012
 - F030B41A018
 - F030B41A030
 - F030B41A033
- 1-10V
- F030B41B000
 - F030B41B001
 - F030B41B006
 - F030B41B012
 - F030B41B018
 - F030B41B030
 - F030B41B033
- Dali
- F030B41D000
 - F030B41D001
 - F030B41D006
 - F030B41D012
 - F030B41D018
 - F030B41D030
 - F030B41D033

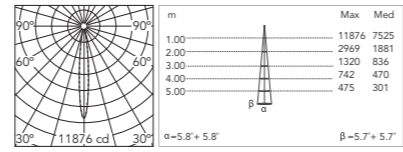

@3000K

Optic Medium

2700K

- Non Dimmable
- F030B22A000
 - F030B22A001
 - F030B22A006
 - F030B22A012
 - F030B22A018
 - F030B22A030
 - F030B22A033
- 1-10V
- F030B22B000
 - F030B22B001
 - F030B22B006
 - F030B22B012
 - F030B22B018
 - F030B22B030
 - F030B22B033
- Dali
- F030B22D000
 - F030B22D001
 - F030B22D006
 - F030B22D012
 - F030B22D018
 - F030B22D030
 - F030B22D033

3000K

- Non Dimmable
- F030B32A000
 - F030B32A001
 - F030B32A006
 - F030B32A012
 - F030B32A018
 - F030B32A030
 - F030B32A033
- 1-10V
- F030B32B000
 - F030B32B001
 - F030B32B006
 - F030B32B012
 - F030B32B018
 - F030B32B030
 - F030B32B033
- Dali
- F030B32D000
 - F030B32D001
 - F030B32D006
 - F030B32D012
 - F030B32D018
 - F030B32D030
 - F030B32D033

4000K

- Non Dimmable
- F030B42A000
 - F030B42A001
 - F030B42A006
 - F030B42A012
 - F030B42A018
 - F030B42A030
 - F030B42A033
- 1-10V
- F030B42B000
 - F030B42B001
 - F030B42B006
 - F030B42B012
 - F030B42B018
 - F030B42B030
 - F030B42B033
- Dali
- F030B42D000
 - F030B42D001
 - F030B42D006
 - F030B42D012
 - F030B42D018
 - F030B42D030
 - F030B42D033

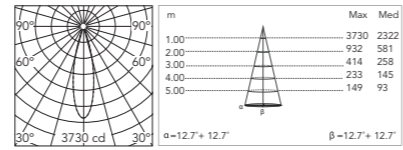

@3000K

Optic Flood

2700K

- Non Dimmable
- F030B23A000
 - F030B23A001
 - F030B23A006
 - F030B23A012
 - F030B23A018
 - F030B23A030
 - F030B23A033
- 1-10V
- F030B23B000
 - F030B23B001
 - F030B23B006
 - F030B23B012
 - F030B23B018
 - F030B23B030
 - F030B23B033
- Dali
- F030B23D000
 - F030B23D001
 - F030B23D006
 - F030B23D012
 - F030B23D018
 - F030B23D030
 - F030B23D033

3000K

- Non Dimmable
- F030B33A000
 - F030B33A001
 - F030B33A006
 - F030B33A012
 - F030B33A018
 - F030B33A030
 - F030B33A033
- 1-10V
- F030B33B000
 - F030B33B001
 - F030B33B006
 - F030B33B012
 - F030B33B018
 - F030B33B030
 - F030B33B033
- Dali
- F030B33D000
 - F030B33D001
 - F030B33D006
 - F030B33D012
 - F030B33D018
 - F030B33D030
 - F030B33D033

4000K

- Non Dimmable
- F030B43A000
 - F030B43A001
 - F030B43A006
 - F030B43A012
 - F030B43A018
 - F030B43A030
 - F030B43A033
- 1-10V
- F030B43B000
 - F030B43B001
 - F030B43B006
 - F030B43B012
 - F030B43B018
 - F030B43B030
 - F030B43B033
- Dali
- F030B43D000
 - F030B43D001
 - F030B43D006
 - F030B43D012
 - F030B43D018
 - F030B43D030
 - F030B43D033

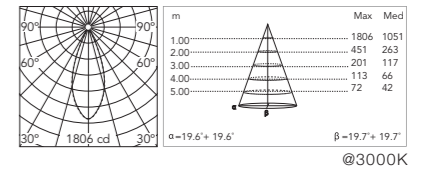

@3000K

Mile Recessed 1: Accessori / Accessories

Scatola in metallo per installazione soffitti in cemento.

Metal installation box for concrete ceiling.

F030Z010000

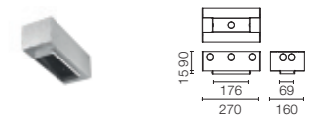

Accessori per versioni non dimmable / Accessories for non-dimmable versions

Sistema di giunzione IP68 H2O Stop anti-condensa a 2 vie 4 poli.

2 way terminal block 4 poles IP68 H2O Stop.

F990C00A000



Sistema di giunzione IP68 H2O Stop anti-condensa a 3/4 vie 4 poli. (Ø5,5÷12mm cavo).

3/4 way terminal block 4 poles IP68 H2O Stop. (ø5,5÷12mm cable).

F990C010000



Accessori per versioni Dimmerabili / Accessories for dimmable versions

Kit connettore 5 poli presa volante + spina EU IP68.

Connector kit 5-pole flying socket + EU plug IP68.

F990C080000



Scatola di derivazione 5 poli 4 vie IP68 (cavi 6-14 mm).

4 way junction box 5 poles IP68 (6-14 mm cables).

F990C030000



Mile Recessed 2

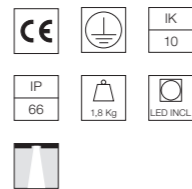
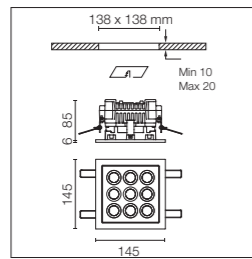
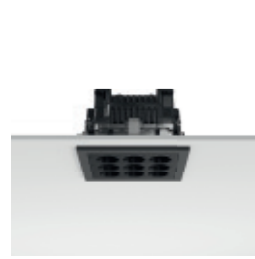

Sorgente luminosa a LED inclusa. Alimentazione elettrica 220-240V ON/OFF integrata e dimmabile 1-10V o DALI integrata. Dotato di spezzone di cavo uscente in neoprene e doppio passacavo per collegamento entra-esce. Molle di fissaggio per controsoffitto incluse. Cassaforma per soffitti in muratura da ordinare separatamente.

LED light source included. Integrated 220-240V ON/OFF and 1-10V/DALI dimmable electrical power. Equipped with neoprene cable outlet and double cable grommet for in/out connection. Ceiling mounting springs included. Box for brick roofing installation to be ordered separately.

Mid - Power Led: 15W - 1677 lm \neq *FIXT 1032 lm - 2700K/CRI>80 - 220-240V / 15W - 1739 lm \neq *FIXT 1344 lm - 3000K/CRI>80 - 220-240V / 15W - 1800 lm \neq *FIXT 1400 lm - 4000K/CRI>80 - 220-240V
*Fixt lm = Spot Optic

Optic Spot

2700K

- Non Dimmable
- F030D21A000
 - F030D21A001
 - F030D21A006
 - F030D21A012
 - F030D21A018
 - F030D21A030
 - F030D21A033
 - 1-10V
 - F030D21B000
 - F030D21B001
 - F030D21B006
 - F030D21B012
 - F030D21B018
 - F030D21B030
 - F030D21B033
 - Dali
 - F030D21D000
 - F030D21D001
 - F030D21D006
 - F030D21D012
 - F030D21D018
 - F030D21D030
 - F030D21D033

3000K

- Non Dimmable
- F030D31A000
 - F030D31A001
 - F030D31A006
 - F030D31A012
 - F030D31A018
 - F030D31A030
 - F030D31A033
 - 1-10V
 - F030D31B000
 - F030D31B001
 - F030D31B006
 - F030D31B012
 - F030D31B018
 - F030D31B030
 - F030D31B033
 - Dali
 - F030D31D000
 - F030D31D001
 - F030D31D006
 - F030D31D012
 - F030D31D018
 - F030D31D030
 - F030D31D033

4000K

- Non Dimmable
- F030D41A000
 - F030D41A001
 - F030D41A006
 - F030D41A012
 - F030D41A018
 - F030D41A030
 - F030D41A033
 - 1-10V
 - F030D41B000
 - F030D41B001
 - F030D41B006
 - F030D41B012
 - F030D41B018
 - F030D41B030
 - F030D41B033
 - Dali
 - F030D41D000
 - F030D41D001
 - F030D41D006
 - F030D41D012
 - F030D41D018
 - F030D41D030
 - F030D41D033

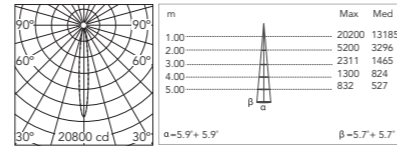

@3000K

Optic Medium

2700K

- Non Dimmable
- F030D22A000
 - F030D22A001
 - F030D22A006
 - F030D22A012
 - F030D22A018
 - F030D22A030
 - F030D22A033
 - 1-10V
 - F030D22B000
 - F030D22B001
 - F030D22B006
 - F030D22B012
 - F030D22B018
 - F030D22B030
 - F030D22B033
 - Dali
 - F030D22D000
 - F030D22D001
 - F030D22D006
 - F030D22D012
 - F030D22D018
 - F030D22D030
 - F030D22D033

3000K

- Non Dimmable
- F030D32A000
 - F030D32A001
 - F030D32A006
 - F030D32A012
 - F030D32A018
 - F030D32A030
 - F030D32A033
 - 1-10V
 - F030D32B000
 - F030D32B001
 - F030D32B006
 - F030D32B012
 - F030D32B018
 - F030D32B030
 - F030D32B033
 - Dali
 - F030D32D000
 - F030D32D001
 - F030D32D006
 - F030D32D012
 - F030D32D018
 - F030D32D030
 - F030D32D033

4000K

- Non Dimmable
- F030D42A000
 - F030D42A001
 - F030D42A006
 - F030D42A012
 - F030D42A018
 - F030D42A030
 - F030D42A033
 - 1-10V
 - F030D42B000
 - F030D42B001
 - F030D42B006
 - F030D42B012
 - F030D42B018
 - F030D42B030
 - F030D42B033
 - Dali
 - F030D42D000
 - F030D42D001
 - F030D42D006
 - F030D42D012
 - F030D42D018
 - F030D42D030
 - F030D42D033

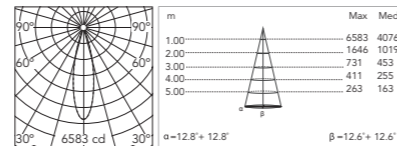

@3000K

Optic Flood

2700K

- Non Dimmable
- F030D23A000
 - F030D23A001
 - F030D23A006
 - F030D23A012
 - F030D23A018
 - F030D23A030
 - F030D23A033
 - 1-10V
 - F030D23B000
 - F030D23B001
 - F030D23B006
 - F030D23B012
 - F030D23B018
 - F030D23B030
 - F030D23B033
 - Dali
 - F030D23D000
 - F030D23D001
 - F030D23D006
 - F030D23D012
 - F030D23D018
 - F030D23D030
 - F030D23D033

3000K

- Non Dimmable
- F030D33A000
 - F030D33A001
 - F030D33A006
 - F030D33A012
 - F030D33A018
 - F030D33A030
 - F030D33A033
 - 1-10V
 - F030D33B000
 - F030D33B001
 - F030D33B006
 - F030D33B012
 - F030D33B018
 - F030D33B030
 - F030D33B033
 - Dali
 - F030D33D000
 - F030D33D001
 - F030D33D006
 - F030D33D012
 - F030D33D018
 - F030D33D030
 - F030D33D033

4000K

- Non Dimmable
- F030D43A000
 - F030D43A001
 - F030D43A006
 - F030D43A012
 - F030D43A018
 - F030D43A030
 - F030D43A033
 - 1-10V
 - F030D43B000
 - F030D43B001
 - F030D43B006
 - F030D43B012
 - F030D43B018
 - F030D43B030
 - F030D43B033
 - Dali
 - F030D43D000
 - F030D43D001
 - F030D43D006
 - F030D43D012
 - F030D43D018
 - F030D43D030
 - F030D43D033

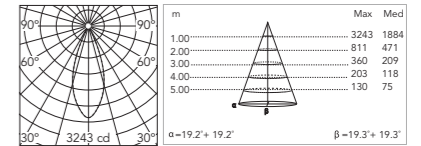

@3000K

Mile Recessed 2: Accessori / Accessories

Scatola in metallo per installazione soffitti in cemento.

Metal installation box for concrete ceiling.

F030Z020000

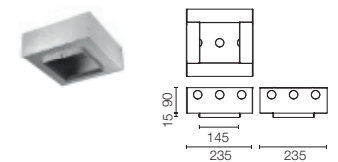

Accessori per versioni non dimmable / Accessories for non-dimmable versions

Sistema di giunzione IP68 H2O Stop anti-condensa a 2 vie 4 poli.

2 way terminal block 4 poles IP68 H2O Stop.

F990C00A000



Sistema di giunzione IP68 H2O Stop anti-condensa a 3/4 vie 4 poli. (Ø5,5÷12mm cavo).

3/4 way terminal block 4 poles IP68 H2O Stop. (ø5,5÷12mm cable).

F990C010000



Accessori per versioni Dimmerabili / Accessories for dimmable versions

Kit connettore 5 poli presa volante + spina EU IP68.

Connector kit 5-pole flying socket + EU plug IP68.

F990C080000



Scatola di derivazione 5 poli 4 vie IP68 (cavi 6-14 mm).

4 way junction box 5 poles IP68 (6-14 mm cables).

F990C030000



Captain Flint



Designed by Michael Anastassiades



Captain Flint

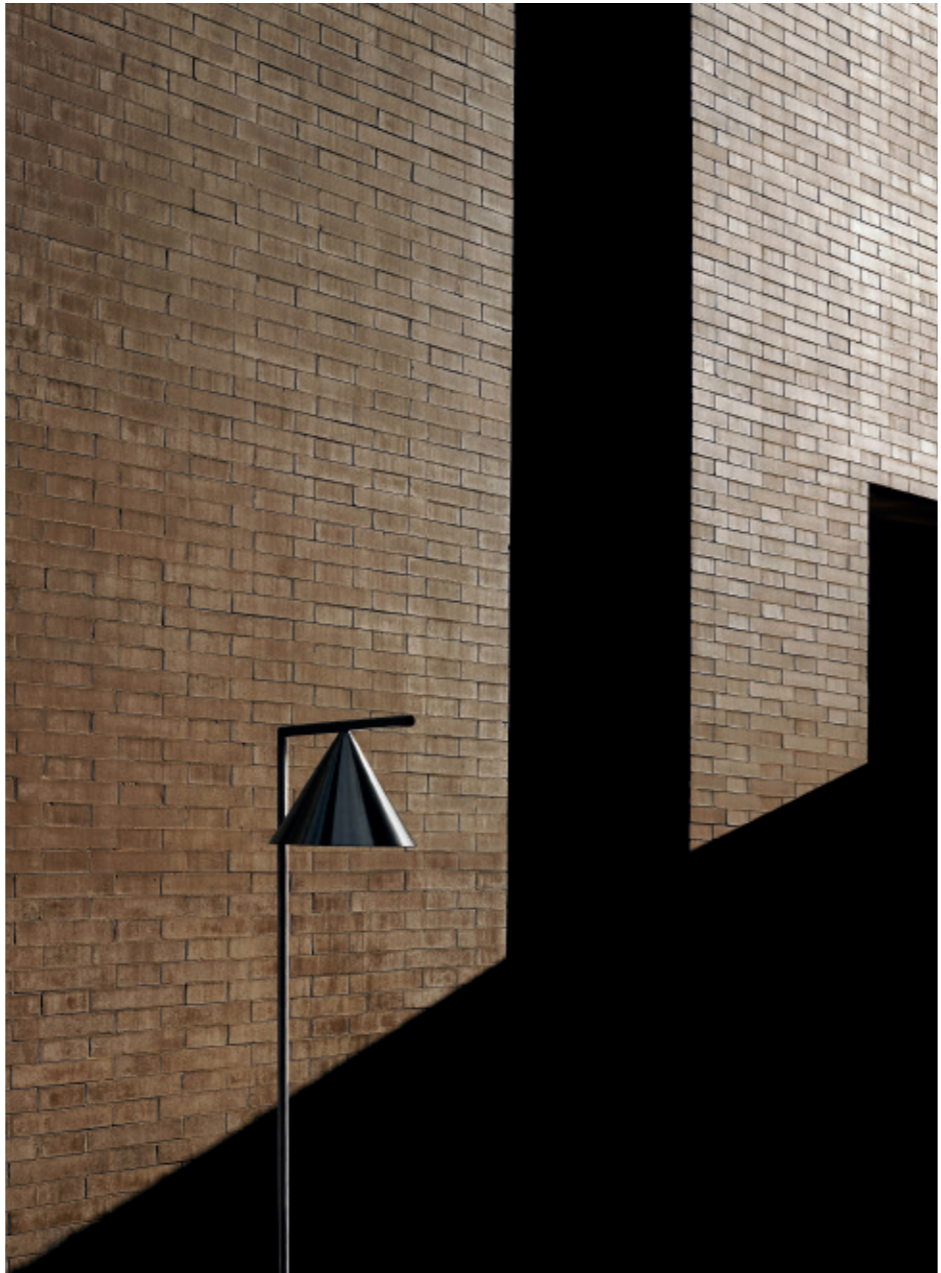

Captain Flint Wall

Famiglia / Family

Captain Flint Outdoor Floor



CoB Led

11W
613 lm - 2700K/CRI 80
658 lm - 3000K/CRI 80
703 lm - 4000K/CRI 80

Captain Flint Outdoor Wall



CoB Led

9,5W
613 lm - 2700K/CRI 80
658 lm - 3000K/CRI 80
703 lm - 4000K/CRI 80

Colori / Colours

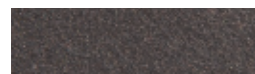

18 Deep Brown



30 Black



37 Burgundy Red



55 Brushed Stainless Steel



59 Brass Finish

Captain Flint Outdoor Floor - Stone bases



18 Deep Brown/Travertino Imperiale



30 Black/Black Lava



37 Burgundy Red/Black Lava



55 Brushed Stainless Steel/
Occhio di Pernice



59 Brass Finish/Grey Lava

Descrizione / Description

Collezione di apparecchi di illuminazione completa di versione a parete e versione da terra per uso esterno.

Versione da parete con testa fissa. Rosone, telaio e cono in acciaio inox 316L spazzolato, verniciato o finitura ottone spazzolato; le parti strutturali vengono trattate con procedimento di conversione chimica al fine di ottenere una efficiente resistenza agli agenti atmosferici. Diffusore in policarbonato opalino anti-UV fotoinciso stampato ad iniezione. Sorgente luminosa a LED inclusa.

Versione da terra con testa orientabile sull'asta orizzontale di 315°, completa di una robusta base in pietra in diverse finiture. Disponibile in quattro combinazioni standard: acciaio verniciato nero/lava nera, acciaio verniciato deep brown/travertino imperiale, ottone satinato/lava grigia, acciaio inox satinato/occhio di pernice. Cavo adatto per outdoor di 5 metri di lunghezza con spina Schuko IP44.

Interruttore dimmer a pedale retroilluminato IP65 lungo il cavo che garantisce le funzioni ON/OFF e regolazione del flusso luminoso 30-100%.

Luminaire family with wall version and outdoor floor version. Wall version with fixed head. Rose, frame and cone in 316L polished or painted stainless steel or polished brass finishes. Structural parts have been treated with a chemical conversion process for effective resistance against atmospheric conditions. Diffuser in photo-recorded and injection molded UV-resistant opalescent polycarbonate. LED light source included.

Floor version with 315° adjustable head in horizontal rod, with a robust stone base that comes in various finishes. Available in four standard combinations: black/black lava painted steel, deep brown/travertino imperiale, satinized brass/grey lava, satinized stainless steel/occhio di pernice. 5-m cable with IP44 Schuko plug suitable for outdoor use. Backlit floor dimmer switch along the IP65 cable enables ON/OFF function and 30-100% brightness regulation.

Captain Flint Outdoor Floor

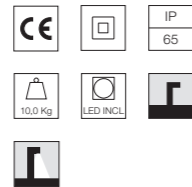
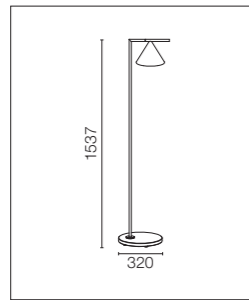

Sorgente luminosa a LED inclusa.
Cavo adatto per outdoor 5 metri di lunghezza con spina Schuko IP44.
Interruttore dimmer a pedale retroilluminato IP65 lungo il cavo che garantisce le funzioni ON/OFF e regolazione del flusso luminoso 30-100%.
Funzione Casambi a richiesta.

LED bulb included.
5-m cable with Schuko IP44 plug suitable for outdoor use.
Backlit floor dimmer switch on the IP65 cable enables ON/OFF function and brightness regulation 30-100%.
Casambi function on demand.

CoB Led: 11W - 1055 lm ≠ FIXT 613 lm - 2700K/CRI>80 - 220-240V / 11W - 1133 lm ≠ FIXT 658 lm - 3000K/CRI>80 - 220-240V / 11W - 1211 lm ≠ FIXT 703 lm - 4000K/CRI>80 - 220-240V

- 2700K**
- F011A21F018
 - F011A22F030
 - F011A22F037
 - F011A24F055
 - F011A23F059

- 3000K**
- F011A31F018
 - F011A32F030
 - F011A32F037
 - F011A34F055
 - F011A33F059

- 4000K**
- F011A41F018
 - F011A42F030
 - F011A42F037
 - F011A44F055
 - F011A43F059

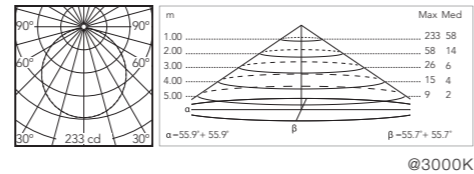

Captain Flint Outdoor Wall

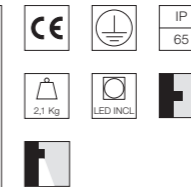
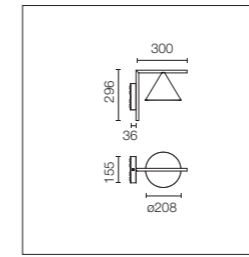

Apparecchio di illuminazione da parete a luce diffusa con testa fissa. Sorgente luminosa a LED inclusa.
Alimentazione elettrica 220-240V ON/OFF o dimmerabile 1-10V / DALI integrata.
La connessione viene eseguita in modo rapido all'interno del rosone con giunto elettrico plug&play e connettore IP68 in dotazione. Staffa di fissaggio inclusa.
Versione 110V a richiesta.

Luminaire for wall-mounting with diffuse light emission and fixed head. LED light source included. Integrated 220-240V ON/OFF or 1-10V/DALI dimmable electrical power.
Connection is quickly ensured in the rose with the plug & play electrical connection and the IP68 connector included. Clamp bracket included.
110V version upon request.

CoB Led: 9,5W - 1055 lm ≠ FIXT 613 lm - 2700K/CRI>80 - 220-240V / 9,5W - 1133 lm ≠ FIXT 658 lm - 3000K/CRI>80 - 220-240V / 9,5W - 1211 lm ≠ FIXT 703 lm - 4000K/CRI>80 - 220-240V

- 2700K**
Non Dimmable
- F011W20A018
 - F011W20A030
 - F011W20A037
 - F011W20A055
 - F011W20A059
 - F011W20B018
 - F011W20B030
 - F011W20B037
 - F011W20B055
 - F011W20B059
 - F011W20D018
 - F011W20D030
 - F011W20D037
 - F011W20D055
 - F011W20D059

- 3000K**
Non Dimmable
- F011W30A018
 - F011W30A030
 - F011W30A037
 - F011W30A055
 - F011W30A059
 - F011W30B018
 - F011W30B030
 - F011W30B037
 - F011W30B055
 - F011W30B059
 - F011W30D018
 - F011W30D030
 - F011W30D037
 - F011W30D055
 - F011W30D059

- 4000K**
Non Dimmable
- F011W40A018
 - F011W40A030
 - F011W40A037
 - F011W40A055
 - F011W40A059
 - F011W40B018
 - F011W40B030
 - F011W40B037
 - F011W40B055
 - F011W40B059
 - F011W40D018
 - F011W40D030
 - F011W40D037
 - F011W40D055
 - F011W40D059

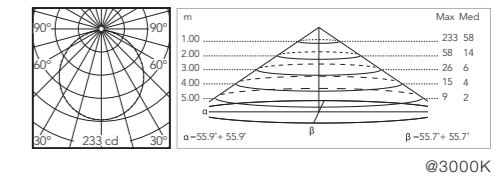

IC Light



Designed by Michael Anastassiades



IC Lights Floor



IC Lights Wall



IC Lights Floor

Famiglia / Family

IC Wall / Ceiling



Led
Max 8W E14

Led
Max 15W E27

IC Floor



Led
Max 8W E14

Led
Max 15W E27

Descrizione / Description

Apparecchio di illuminazione da parete-plafone a luce diffusa per uso esterno disponibile in due dimensioni. Telaio in acciaio inox spazzolato, in finitura ottone spazzolato o verniciato colore nero opaco o rosso burgundy. Le parti strutturali dell'apparecchio vengono trattate con procedimento di conversione chimica al fine di ottenere una efficiente resistenza agli agenti atmosferici. Durante il montaggio e la manutenzione degli apparecchi bisogna prestare particolare attenzione a non danneggiare la verniciatura a polvere. Diffusore opalino in vetro soffiato bianco latte lucido. L'apparecchio è fornito completo con guarnizione per la connessione a tenuta IP. Sorgente luminosa esclusa attacco E14/E27.

Wall- or ceiling-mounted light fitting with diffuse light for exterior use available in two sizes. Frame in brushed stainless steel, brushed brass finish or painted opaque black or burgundy. The structure of the fitting is treated with a chemical conversion process for effective resistance to atmospheric agents. Special attention is recommended during installation and maintenance to prevent damage to the powder coating. Opalescent diffuser in shiny white translucent blown glass. The light comes with seals for IP-rated connection. Light source with E14/E27 connection not included.

Colori / Colours



18 Deep Brown



30 Black



37 Burgundy Red



55 Brushed Stainless Steel



59 Brass Finish

IC Floor Outdoor - Stone bases



30 Black/Black Lava



18 Deep Brown/Travertino Imperiale



37 Burgundy Red/Black Lava



55 Brushed Stainless Steel/
Occhio di Pernice



59 Brass Finish/Grey Lava

IC Ceiling Wall 1 Outdoor

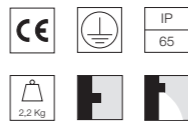
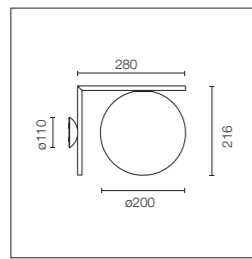

Sorgente luminosa esclusa. Apparecchio di illuminazione da parete/soffitto a luce diffusa. Telaio in ottone, spazzolato e verniciato trasparente o acciaio cromato. Diffusore opalino di vetro soffiato.

Light source excluded. Optional LED bulb sold separately. Wall mounting system contains the wiring system. Watertight cable gland included.

Led: max 8W - E14 - 220-240V

- F012H00C018
- F012H00C030
- F012H00C037
- F012H00C055
- F012H00C059

Accessori / Accessories

- 1 x LED 8W E14 900lm 3000K cod. RF30264 [e] DIMMER
- 1 x LED 8W E14 900lm 2700K cod. RF30263 [e] DIMMER

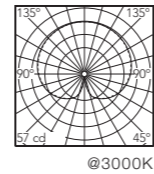

IC Floor 1 Outdoor

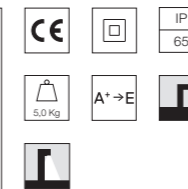
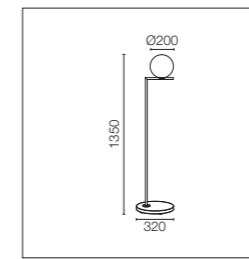

Sorgente luminosa esclusa. Cavo adatto per outdoor 5 metri di lunghezza con spina Schuko IP44. Interruttore dimmer a pedale retroilluminato IP65 lungo il cavo che garantisce le funzioni ON/OFF e regolazione del flusso luminoso 30-100% (con lampadina a LED Dimmerabile).

Bulb not included. 5-m cable with Schuko IP44 plug suitable for outdoor use. Backlit floor dimmer switch on the IP65 cable enables ON/OFF function and brightness regulation 30-100% (with dimmable LED bulb).

Led: max 8W - E14 - 220-240V

- F012A01C018
- F012A02C030
- F012A02C037
- F012A04C055
- F012A03C059

Accessori / Accessories

- 1 x LED 8W E14 900lm 3000K cod. RF30264 [e] DIMMER
- 1 x LED 8W E14 900lm 2700K cod. RF30263 [e] DIMMER

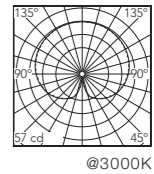

IC Ceiling Wall 2 Outdoor

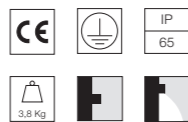
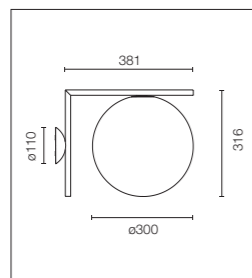

Sorgente luminosa esclusa. Apparecchio di illuminazione da parete/soffitto a luce diffusa. Telaio in ottone, spazzolato e verniciato trasparente o acciaio cromato. Diffusore opalino di vetro soffiato.

Light source excluded. Optional LED bulb sold separately. Wall mounting system contains the wiring system. Watertight cable gland included.

Led: max 15W - E27 - 220-240V

- F012J00C018
- F012J00C030
- F012J00C037
- F012J00C055
- F012J00C059

Accessori / Accessories

- 1 x LED 15W E27 2000lm 2700K cod. RF28665 [e] DIMMER
- 1 x LED 15W E27 2000lm 3000K cod. RF28666 [e] DIMMER

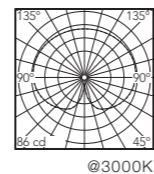

IC Floor 2 Outdoor

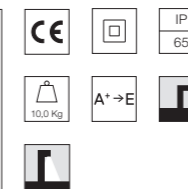
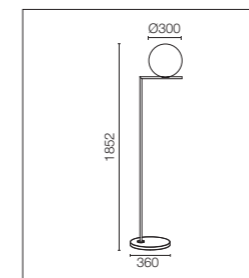

Sorgente luminosa esclusa. Cavo adatto per outdoor 5 metri di lunghezza con spina Schuko IP44. Interruttore dimmer a pedale retroilluminato IP65 lungo il cavo che garantisce le funzioni ON/OFF e regolazione del flusso luminoso 30-100% (con lampadina a LED Dimmerabile).

Bulb not included. 5-m cable with Schuko IP44 plug suitable for outdoor use. Backlit floor dimmer switch on the IP65 cable enables ON/OFF function and brightness regulation 30-100% (with dimmable LED bulb).

Led: max 15W - E27 - 220-240V

- F012B01C018
- F012B02C030
- F012B02C037
- F012B04C055
- F012B03C059

Accessori / Accessories

- 1 x LED 15W E27 2000lm 2700K cod. RF28665 [e] DIMMER
- 1 x LED 15W E27 2000lm 3000K cod. RF28666 [e] DIMMER

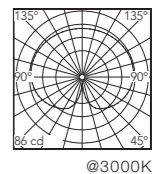

Caule

Designed by Patricia Urquiola





Caule Floor

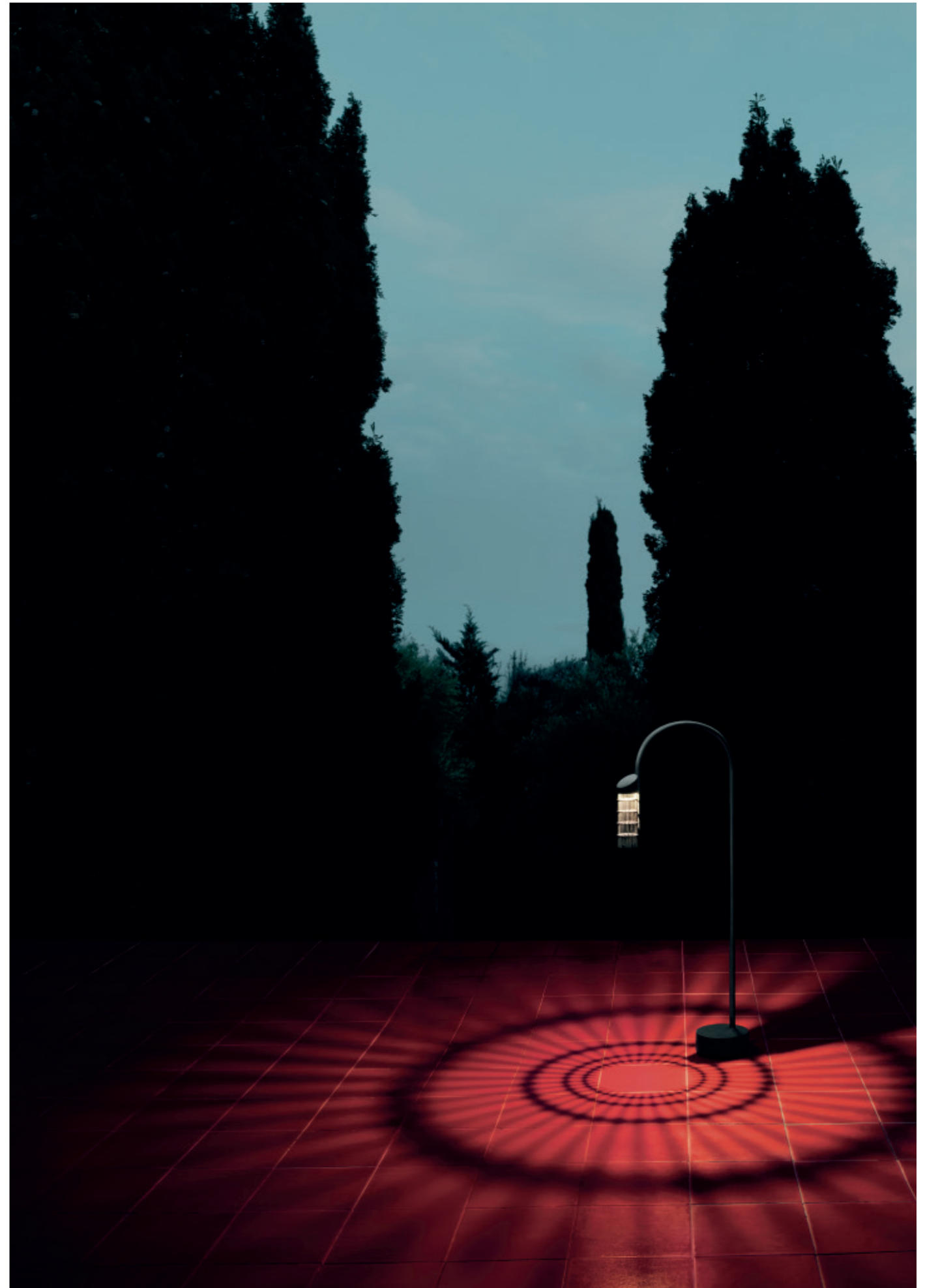

Caule Bollard Nest

Famiglia / Family

Caule Floor

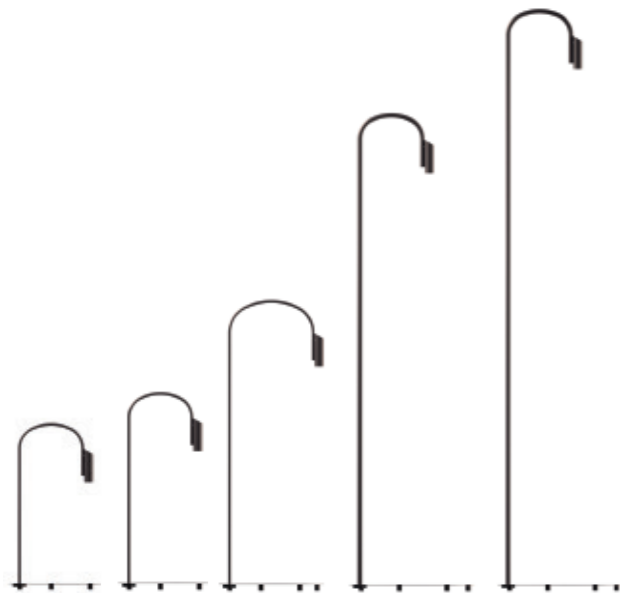

Power Led
10W
282 lm - 2700K/CRI 80
303 lm - 3000K/CRI 80
324 lm - 4000K/CRI 80

Caule Floor Nest



Power Led
10W
282 lm - 2700K/CRI 80
303 lm - 3000K/CRI 80
324 lm - 4000K/CRI 80

Caule Bollard

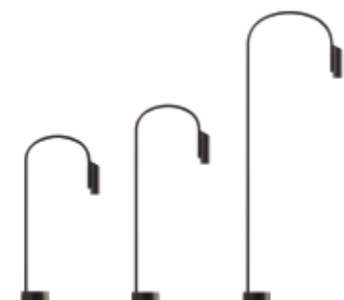

Power Led
10W
282 lm - 2700K/CRI 80
303 lm - 3000K/CRI 80
324 lm - 4000K/CRI 80

Caule Bollard Nest



Power Led
10W
282 lm - 2700K/CRI 80
303 lm - 3000K/CRI 80
324 lm - 4000K/CRI 80

Colori / Colours



01 White



06 Grey



12 Forest Green



18 Deep Brown



30 Black



33 Anthracite

Descrizione / Description

Collezione di apparecchi di illuminazione da esterno in versione lampada da terra mobile e in versione bollard, disponibili in diverse altezze.

Sono caratterizzate dal design morbido e flessuoso dello stelo e dalla testa disponibile in due modelli differenti: testa monolite per una luce diretta soft, testa con cover Nest a maglia metallica per una luce diffusa e disegnata.

La struttura dello stelo è realizzata in acciaio inox aisi 304 per una efficiente resistenza agli agenti atmosferici. La base è in acciaio inox aisi 304 per la versione lampada da terra mobile e in alluminio pressofuso per la versione bollard. La testa, in cui è recessa la sorgente LED inclusa, è in stampo di alluminio pressofuso; nella versione Nest la cover è realizzata in maglia metallica in acciaio inox aisi 316L.

Le parti strutturali dell'apparecchio vengono trattate con procedimento di conversione chimica al fine di ottenere una efficiente resistenza alla corrosione degli agenti atmosferici. Lo schermo di protezione della sorgente luminosa è in vetro sabbato per la testa monolite, in metacrilato trasparente per la versione Nest.

La versione lampada da terra è completata da cavo adatto per outdoor 5 metri di lunghezza con spina Schuko IP44 e interruttore dimmer a pedale retroilluminato IP65 che garantisce le funzioni ON/OFF e regolazione del flusso luminoso. La versione bollard è fornita con uno spezzone di cavo uscente in neoprene di 200 mm di lunghezza ed è pronto per l'installazione su qualsiasi pavimento. Disponibile come accessorio da ordinare separatamente la cassaforma per l'installazione su una pavimentazione da gettare con plinto di cemento.

Collection of outdoor lighting units in a movable floor lamp version and a bollard version, both available in different heights.

The lamps are characterized by their soft, pliable stem. The lamp head is available in two different models: solid, for direct soft light, or with a 'nest' cover, a metallic mesh creating a unique wash of diffuse light.

The structure of the stem is made of AISI 304 stainless steel for effective resistance to atmospheric agents. The base of the movable floor version is made of AISI 304 stainless steel for and the bollard version is made of die-cast aluminium.

The lamp head, which holds the included LED light source, is made of moulded aluminium; the cover of the 'nest' version is made of a metallic mesh in AISI 316L stainless steel.

The structure is treated with a chemical conversion process for effective resistance to atmospheric agents.

The screen protecting the light source is made of sanded glass for the solid head and methacrylate for the 'nest' version.

The floor lamp version comes with 5 metres of cable appropriate for outdoor use with a Schuko IP44 and IP65 backlit pedal dimmer switch for easy ON/OFF and to adjust the amount of light.

The bollard version comes with a 200-mm length of neoprene cable and is ready for installation on any flooring. Optional accessory (sold separately): box for installation on flooring laid over concrete.

Caule Floor 1

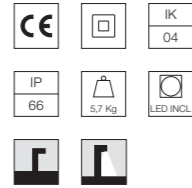
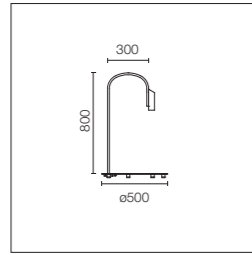

Sorgente luminosa a LED inclusa. Alimentazione elettrica 220-240V 50-60 Hz integrata. Cavo adatto per outdoor 5 metri di lunghezza con spina Schuko IP44. Interruttore dimmer a pedale retroilluminato IP65 lungo il cavo che garantisce le funzioni ON/OFF e regolazione del flusso luminoso. Versione 110V a richiesta. Dimmer Control switch integrato (lungo il cavo). Funzione Casambi a richiesta.

LED light source included. Integrated 220-240V 50-60 Hz electrical power. Cable suitable for outdoors, 5-m long with Schuko IP44 plug. IP65 backlit pedal dimmer switch on the cable for easy ON/OFF and to adjust the amount of light. 110V version upon request. Integrated dimmer control switch (on the cable). Casambi function on demand.

Power Led: 10W - 447 lm ≠ FIXT 282 lm - 2700K/CRI 80 - 220-240V / 10W - 480 lm ≠ FIXT 303 lm - 3000K/CRI 80 - 220-240V / 10W - 513 lm ≠ FIXT 324 lm - 4000K/CRI 80 - 220-240V

2700K

- F016M21K001
- F016M21K006
- F016M21K012
- F016M21K018
- F016M21K030
- F016M21K033

3000K

- F016M31K001
- F016M31K006
- F016M31K012
- F016M31K018
- F016M31K030
- F016M31K033

4000K

- F016M41K001
- F016M41K006
- F016M41K012
- F016M41K018
- F016M41K030
- F016M41K033

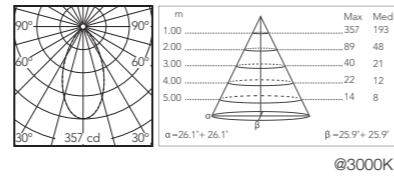

Caule Floor 2

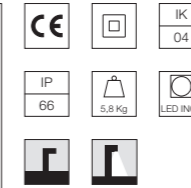
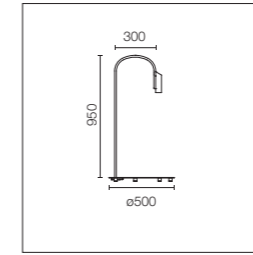

Sorgente luminosa a LED inclusa. Alimentazione elettrica 220-240V 50-60 Hz integrata. Cavo adatto per outdoor 5 metri di lunghezza con spina Schuko IP44. Interruttore dimmer a pedale retroilluminato IP65 lungo il cavo che garantisce le funzioni ON/OFF e regolazione del flusso luminoso. Versione 110V a richiesta. Dimmer Control switch integrato (lungo il cavo). Funzione Casambi a richiesta.

LED light source included. Integrated 220-240V 50-60 Hz electrical power. Cable suitable for outdoors, 5-m long with Schuko IP44 plug. IP65 backlit pedal dimmer switch on the cable for easy ON/OFF and to adjust the amount of light. 110V version upon request. Integrated dimmer control switch (on the cable). Casambi function on demand.

Power Led: 10W - 447 lm ≠ FIXT 282 lm - 2700K/CRI 80 - 220-240V / 10W - 480 lm ≠ FIXT 303 lm - 3000K/CRI 80 - 220-240V / 10W - 513 lm ≠ FIXT 324 lm - 4000K/CRI 80 - 220-240V

2700K

- F016M22K001
- F016M22K006
- F016M22K012
- F016M22K018
- F016M22K030
- F016M22K033

3000K

- F016M32K001
- F016M32K006
- F016M32K012
- F016M32K018
- F016M32K030
- F016M32K033

4000K

- F016M42K001
- F016M42K006
- F016M42K012
- F016M42K018
- F016M42K030
- F016M42K033

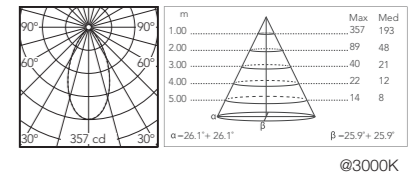

Caule Floor 1 Nest

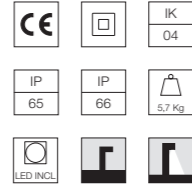
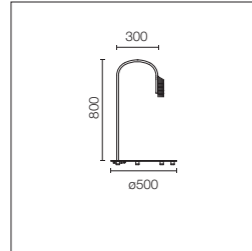

Sorgente luminosa a LED inclusa. Alimentazione elettrica 220-240V 50-60 Hz integrata. Cavo adatto per outdoor 5 metri di lunghezza con spina Schuko IP44. Interruttore dimmer a pedale retroilluminato IP65 lungo il cavo che garantisce le funzioni ON/OFF e regolazione del flusso luminoso. Versione 110V a richiesta. Dimmer Control switch integrato (lungo il cavo). Funzione Casambi a richiesta.

LED light source included. Integrated 220-240V 50-60 Hz electrical power. Cable suitable for outdoors, 5-m long with Schuko IP44 plug. IP65 backlit pedal dimmer switch on the cable for easy ON/OFF and to adjust the amount of light. 110V version upon request. Integrated dimmer control switch (on the cable). Casambi function on demand.

Power Led: 10W - 447 lm ≠ FIXT 124 lm - 2700K/CRI 80 - 220-240V / 10W - 480 lm ≠ FIXT 137 lm - 3000K/CRI 80 - 220-240V / 10W - 513 lm ≠ FIXT 143 lm - 4000K/CRI 80 - 220-240V

2700K

- F016N21K001
- F016N21K006
- F016N21K012
- F016N21K018
- F016N21K030
- F016N21K033

3000K

- F016N31K001
- F016N31K006
- F016N31K012
- F016N31K018
- F016N31K030
- F016N31K033

4000K

- F016N41K001
- F016N41K006
- F016N41K012
- F016N41K018
- F016N41K030
- F016N41K033

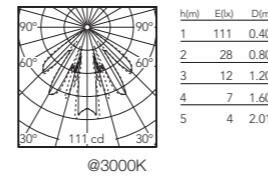

Caule Floor 2 Nest

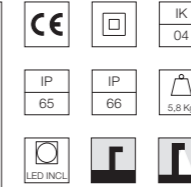
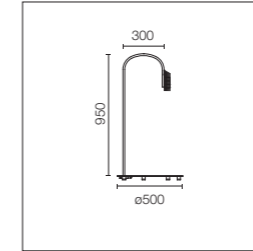

Sorgente luminosa a LED inclusa. Alimentazione elettrica 220-240V 50-60 Hz integrata. Cavo adatto per outdoor 5 metri di lunghezza con spina Schuko IP44. Interruttore dimmer a pedale retroilluminato IP65 lungo il cavo che garantisce le funzioni ON/OFF e regolazione del flusso luminoso. Versione 110V a richiesta. Dimmer Control switch integrato (lungo il cavo). Funzione Casambi a richiesta.

LED light source included. Integrated 220-240V 50-60 Hz electrical power. Cable suitable for outdoors, 5-m long with Schuko IP44 plug. IP65 backlit pedal dimmer switch on the cable for easy ON/OFF and to adjust the amount of light. 110V version upon request. Integrated dimmer control switch (on the cable). Casambi function on demand.

Power Led: 10W - 447 lm ≠ FIXT 124 lm - 2700K/CRI 80 - 220-240V / 10W - 480 lm ≠ FIXT 137 lm - 3000K/CRI 80 - 220-240V / 10W - 513 lm ≠ FIXT 143 lm - 4000K/CRI 80 - 220-240V

2700K

- F016N22K001
- F016N22K006
- F016N22K012
- F016N22K018
- F016N22K030
- F016N22K033

3000K

- F016N32K001
- F016N32K006
- F016N32K012
- F016N32K018
- F016N32K030
- F016N32K033

4000K

- F016N42K001
- F016N42K006
- F016N42K012
- F016N42K018
- F016N42K030
- F016N42K033

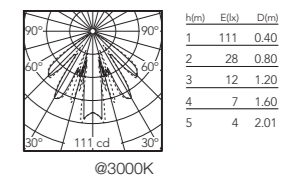

Caule Floor 3

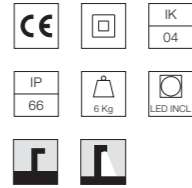
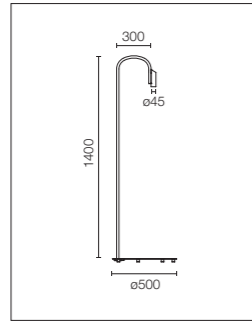

Sorgente luminosa a LED inclusa. Alimentazione elettrica 220-240V 50-60 Hz integrata. Cavo adatto per outdoor 5 metri di lunghezza con spina Schuko IP44. Interruttore dimmer a pedale retroilluminato IP65 lungo il cavo che garantisce le funzioni ON/OFF e regolazione del flusso luminoso. Versione 110V a richiesta. Dimmer Control switch integrato (lungo il cavo). Funzione Casambi a richiesta.

LED light source included. Integrated 220-240V 50-60 Hz electrical power. Cable suitable for outdoors, 5-m long with Schuko IP44 plug. IP65 backlit pedal dimmer switch on the cable for easy ON/OFF and to adjust the amount of light. 110V version upon request. Integrated dimmer control switch (on the cable). Casambi function on demand.

Power Led: 10W - 447 lm ≠ FIXT 282 lm - 2700K/CRI 80 - 220-240V / 10W - 480 lm ≠ FIXT 303 lm - 3000K/CRI 80 - 220-240V / 10W - 513 lm ≠ FIXT 324 lm - 4000K/CRI 80 - 220-240V

2700K

- F016M23K001
- F016M23K006
- F016M23K012
- F016M23K018
- F016M23K030
- F016M23K033

3000K

- F016M33K001
- F016M33K006
- F016M33K012
- F016M33K018
- F016M33K030
- F016M33K033

4000K

- F016M43K001
- F016M43K006
- F016M43K012
- F016M43K018
- F016M43K030
- F016M43K033

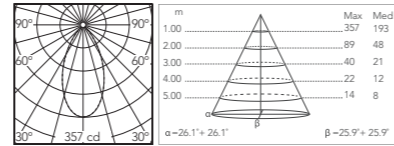

@3000K

Caule Floor 3 Nest

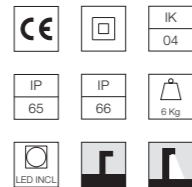
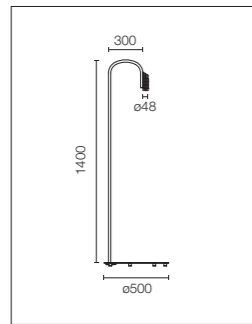

Sorgente luminosa a LED inclusa. Alimentazione elettrica 220-240V 50-60 Hz integrata. Cavo adatto per outdoor 5 metri di lunghezza con spina Schuko IP44. Interruttore dimmer a pedale retroilluminato IP65 lungo il cavo che garantisce le funzioni ON/OFF e regolazione del flusso luminoso. Versione 110V a richiesta. Dimmer Control switch integrato (lungo il cavo). Funzione Casambi a richiesta.

LED light source included. Integrated 220-240V 50-60 Hz electrical power. Cable suitable for outdoors, 5-m long with Schuko IP44 plug. IP65 backlit pedal dimmer switch on the cable for easy ON/OFF and to adjust the amount of light. 110V version upon request. Integrated dimmer control switch (on the cable). Casambi function on demand.

Power Led: 10W - 447 lm ≠ FIXT 124 lm - 2700K/CRI 80 - 220-240V / 10W - 480 lm ≠ FIXT 137 lm - 3000K/CRI 80 - 220-240V / 10W - 513 lm ≠ FIXT 143 lm - 4000K/CRI 80 - 220-240V

2700K

- F016N23K001
- F016N23K006
- F016N23K012
- F016N23K018
- F016N23K030
- F016N23K033

3000K

- F016N33K001
- F016N33K006
- F016N33K012
- F016N33K018
- F016N33K030
- F016N33K033

4000K

- F016N43K001
- F016N43K006
- F016N43K012
- F016N43K018
- F016N43K030
- F016N43K033

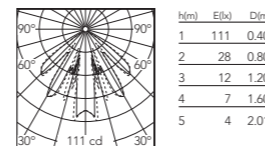

@3000K

Caule Floor 4

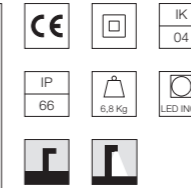
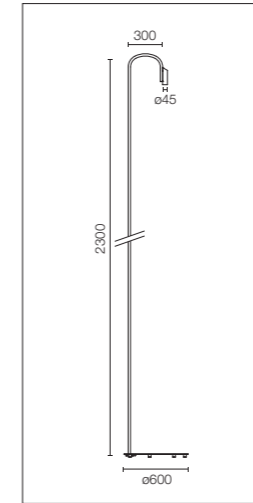

Sorgente luminosa a LED inclusa. Alimentazione elettrica 220-240V 50-60 Hz integrata. Cavo adatto per outdoor 5 metri di lunghezza con spina Schuko IP44. Interruttore dimmer a pedale retroilluminato IP65 lungo il cavo che garantisce le funzioni ON/OFF e regolazione del flusso luminoso. Versione 110V a richiesta. Dimmer Control switch integrato (lungo il cavo). Funzione Casambi a richiesta.

LED light source included. Integrated 220-240V 50-60 Hz electrical power. Cable suitable for outdoors, 5-m long with Schuko IP44 plug. IP65 backlit pedal dimmer switch on the cable for easy ON/OFF and to adjust the amount of light. 110V version upon request. Integrated dimmer control switch (on the cable). Casambi function on demand.

Power Led: 10W - 447 lm ≠ FIXT 245 lm - 2700K/CRI 80 - 220-240V / 10W - 480 lm ≠ FIXT 263 lm - 3000K/CRI 80 - 220-240V / 10W - 513 lm ≠ FIXT 281 lm - 4000K/CRI 80 - 220-240V

2700K

- F016M24K001
- F016M24K006
- F016M24K012
- F016M24K018
- F016M24K030
- F016M24K033

3000K

- F016M34K001
- F016M34K006
- F016M34K012
- F016M34K018
- F016M34K030
- F016M34K033

4000K

- F016M44K001
- F016M44K006
- F016M44K012
- F016M44K018
- F016M44K030
- F016M44K033

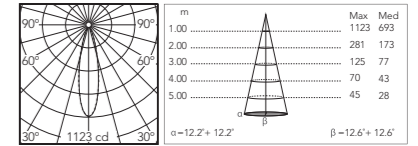

@3000K

Caule Floor 5

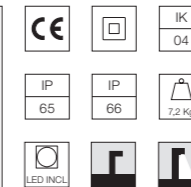
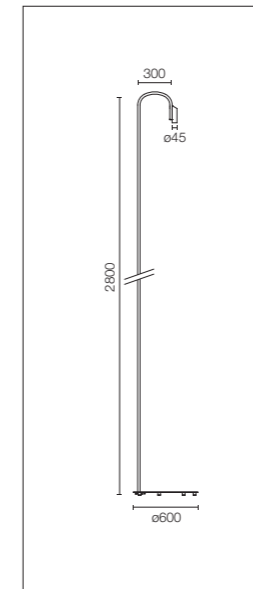

Sorgente luminosa a LED inclusa. Alimentazione elettrica 220-240V 50-60 Hz integrata. Cavo adatto per outdoor 5 metri di lunghezza con spina Schuko IP44. Interruttore dimmer a pedale retroilluminato IP65 lungo il cavo che garantisce le funzioni ON/OFF e regolazione del flusso luminoso. Versione 110V a richiesta. Dimmer Control switch integrato (lungo il cavo). Funzione Casambi a richiesta.

LED light source included. Integrated 220-240V 50-60 Hz electrical power. Cable suitable for outdoors, 5-m long with Schuko IP44 plug. IP65 backlit pedal dimmer switch on the cable for easy ON/OFF and to adjust the amount of light. 110V version upon request. Integrated dimmer control switch (on the cable). Casambi function on demand.

Power Led: 10W - 447 lm ≠ FIXT 245 lm - 2700K/CRI 80 - 220-240V / 10W - 480 lm ≠ FIXT 263 lm - 3000K/CRI 80 - 220-240V / 10W - 513 lm ≠ FIXT 281 lm - 4000K/CRI 80 - 220-240V

2700K

- F016M25K001
- F016M25K006
- F016M25K012
- F016M25K018
- F016M25K030
- F016M25K033

3000K

- F016M35K001
- F016M35K006
- F016M35K012
- F016M35K018
- F016M35K030
- F016M35K033

4000K

- F016M45K001
- F016M45K006
- F016M45K012
- F016M45K018
- F016M45K030
- F016M45K033

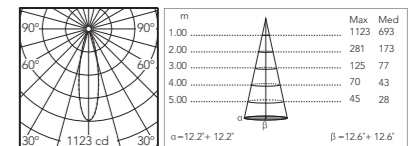

@3000K

Caule Bollard 1

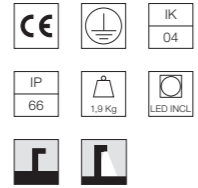
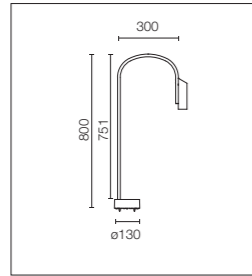

Sorgente luminosa a LED inclusa. Alimentazione elettrica ON/OFF o dimmerabile 220-240V integrata. L'apparecchio è installabile su qualsiasi pavimento per mezzo di tasselli. Cassaforma per l'installazione su pavimentazione da gettare con plinto di cemento da ordinare separatamente. Versione 110V a richiesta.

LED light source included. Integrated 220-240V ON/OFF or dimmable electrical power. The device may be installed on any flooring with anchors. Box for installation on flooring laid over concrete sold separately. 110V version upon request.

Power Led: 5W - 447 lm ≠ FIXT 282 lm - 2700K/CRI 80 - 220-240V / 5W - 480 lm ≠ FIXT 303 lm - 3000K/CRI 80 - 220-240V / 5W - 513 lm ≠ FIXT 324 lm - 4000K/CRI 80 - 220-240V

2700K

- Non Dimmable
- F016A21A001
- F016A21A006
- F016A21A012
- F016A21A018
- F016A21A030
- F016A21A033
- 1-10V
- F016A21B001
- F016A21B006
- F016A21B012
- F016A21B018
- F016A21B030
- F016A21B033
- Dali
- F016A21D001
- F016A21D006
- F016A21D012
- F016A21D018
- F016A21D030
- F016A21D033

3000K

- Non Dimmable
- F016A31A001
- F016A31A006
- F016A31A012
- F016A31A018
- F016A31A030
- F016A31A033
- 1-10V
- F016A31B001
- F016A31B006
- F016A31B012
- F016A31B018
- F016A31B030
- F016A31B033
- Dali
- F016A31D001
- F016A31D006
- F016A31D012
- F016A31D018
- F016A31D030
- F016A31D033

4000K

- Non Dimmable
- F016A41A001
- F016A41A006
- F016A41A012
- F016A41A018
- F016A41A030
- F016A41A033
- 1-10V
- F016A41B001
- F016A41B006
- F016A41B012
- F016A41B018
- F016A41B030
- F016A41B033
- Dali
- F016A41D001
- F016A41D006
- F016A41D012
- F016A41D018
- F016A41D030
- F016A41D033

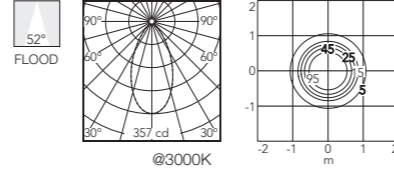

Caule Bollard 1 Nest

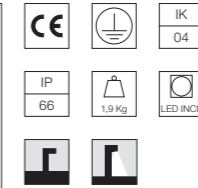
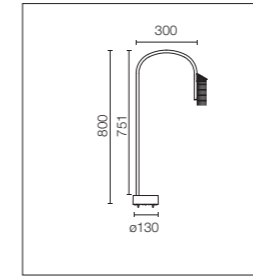

Sorgente luminosa a LED inclusa. Alimentazione elettrica ON/OFF o dimmerabile 220-240V integrata. L'apparecchio è installabile su qualsiasi pavimento per mezzo di tasselli. Cassaforma per l'installazione su pavimentazione da gettare con plinto di cemento da ordinare separatamente. Versione 110V a richiesta.

LED light source included. Integrated 220-240V ON/OFF or dimmable electrical power. The device may be installed on any flooring with anchors. Box for installation on flooring laid over concrete sold separately. 110V version upon request.

Power Led: 5W - 447 lm ≠ FIXT 124 lm - 2700K/CRI 80 - 220-240V / 5W - 480 lm ≠ FIXT 137 lm - 3000K/CRI 80 - 220-240V / 5W - 513 lm ≠ FIXT 143 lm - 4000K/CRI 80 - 220-240V

2700K

- Non Dimmable
- F016B21A001
- F016B21A006
- F016B21A012
- F016B21A018
- F016B21A030
- F016B21A033
- 1-10V
- F016B21B001
- F016B21B006
- F016B21B012
- F016B21B018
- F016B21B030
- F016B21B033
- Dali
- F016B21D001
- F016B21D006
- F016B21D012
- F016B21D018
- F016B21D030
- F016B21D033

3000K

- Non Dimmable
- F016B31A001
- F016B31A006
- F016B31A012
- F016B31A018
- F016B31A030
- F016B31A033
- 1-10V
- F016B31B001
- F016B31B006
- F016B31B012
- F016B31B018
- F016B31B030
- F016B31B033
- Dali
- F016B31D001
- F016B31D006
- F016B31D012
- F016B31D018
- F016B31D030
- F016B31D033

4000K

- Non Dimmable
- F016B41A001
- F016B41A006
- F016B41A012
- F016B41A018
- F016B41A030
- F016B41A033
- 1-10V
- F016B41B001
- F016B41B006
- F016B41B012
- F016B41B018
- F016B41B030
- F016B41B033
- Dali
- F016B41D001
- F016B41D006
- F016B41D012
- F016B41D018
- F016B41D030
- F016B41D033

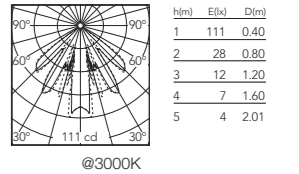

Caule Bollard 2

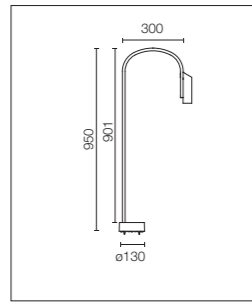

Sorgente luminosa a LED inclusa. Alimentazione elettrica ON/OFF o dimmerabile 220-240V integrata. L'apparecchio è installabile su qualsiasi pavimento per mezzo di tasselli. Cassaforma per l'installazione su pavimentazione da gettare con plinto di cemento da ordinare separatamente. Versione 110V a richiesta.

LED light source included. Integrated 220-240V ON/OFF or dimmable electrical power. The device may be installed on any flooring with anchors. Box for installation on flooring laid over concrete sold separately. 110V version upon request.

Power Led: 5W - 447 lm ≠ FIXT 282 lm - 2700K/CRI 80 - 220-240V / 5W - 480 lm ≠ FIXT 303 lm - 3000K/CRI 80 - 220-240V / 5W - 513 lm ≠ FIXT 324 lm - 4000K/CRI 80 - 220-240V

2700K

- F016A22A001 Non Dimmable
- F016A22A006
- F016A22A012
- F016A22A018
- F016A22A030
- F016A22A033 1-10V
- F016A22B001
- F016A22B006
- F016A22B012
- F016A22B018
- F016A22B030
- F016A22B033
- F016A22D001 Dali
- F016A22D006
- F016A22D012
- F016A22D018
- F016A22D030
- F016A22D033

3000K

- F016A32A001 Non Dimmable
- F016A32A006
- F016A32A012
- F016A32A018
- F016A32A030
- F016A32A033 1-10V
- F016A32B001
- F016A32B006
- F016A32B012
- F016A32B018
- F016A32B030
- F016A32B033
- F016A32D001 Dali
- F016A32D006
- F016A32D012
- F016A32D018
- F016A32D030
- F016A32D033

4000K

- F016A42A001 Non Dimmable
- F016A42A006
- F016A42A012
- F016A42A018
- F016A42A030
- F016A42A033 1-10V
- F016A42B001
- F016A42B006
- F016A42B012
- F016A42B018
- F016A42B030
- F016A42B033
- F016A42D001 Dali
- F016A42D006
- F016A42D012
- F016A42D018
- F016A42D030
- F016A42D033

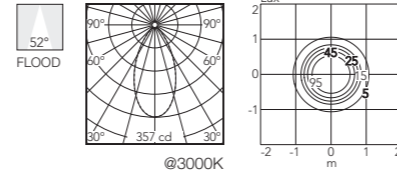

Caule Bollard 2 Nest

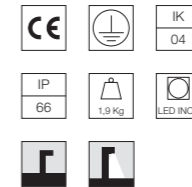
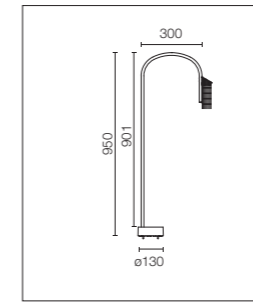

Sorgente luminosa a LED inclusa. Alimentazione elettrica ON/OFF o dimmerabile 220-240V integrata. L'apparecchio è installabile su qualsiasi pavimento per mezzo di tasselli. Cassaforma per l'installazione su pavimentazione da gettare con plinto di cemento da ordinare separatamente. Versione 110V a richiesta.

LED light source included. Integrated 220-240V ON/OFF or dimmable electrical power. The device may be installed on any flooring with anchors. Box for installation on flooring laid over concrete sold separately. 110V version upon request.

Power Led: 5W - 447 lm ≠ FIXT 124 lm - 2700K/CRI 80 - 220-240V / 5W - 480 lm ≠ FIXT 137 lm - 3000K/CRI 80 - 220-240V / 5W - 513 lm ≠ FIXT 143 lm - 4000K/CRI 80 - 220-240V

2700K

- F016B22A001 Non Dimmable
- F016B22A006
- F016B22A012
- F016B22A018
- F016B22A030
- F016B22A033 1-10V
- F016B22B001
- F016B22B006
- F016B22B012
- F016B22B018
- F016B22B030
- F016B22B033
- F016B22D001 Dali
- F016B22D006
- F016B22D012
- F016B22D018
- F016B22D030
- F016B22D033

3000K

- F016B32A001 Non Dimmable
- F016B32A006
- F016B32A012
- F016B32A018
- F016B32A030
- F016B32A033 1-10V
- F016B32B001
- F016B32B006
- F016B32B012
- F016B32B018
- F016B32B030
- F016B32B033
- F016B32D001 Dali
- F016B32D006
- F016B32D012
- F016B32D018
- F016B32D030
- F016B32D033

4000K

- F016B42A001 Non Dimmable
- F016B42A006
- F016B42A012
- F016B42A018
- F016B42A030
- F016B42A033 1-10V
- F016B42B001
- F016B42B006
- F016B42B012
- F016B42B018
- F016B42B030
- F016B42B033
- F016B42D001 Dali
- F016B42D006
- F016B42D012
- F016B42D018
- F016B42D030
- F016B42D033

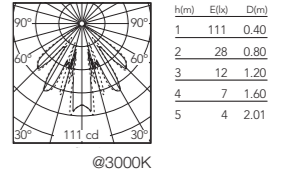

Caule Bollard 3

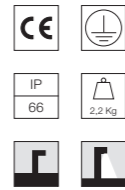
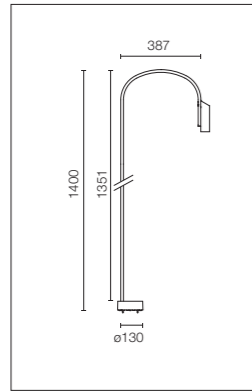

Sorgente luminosa a LED inclusa. Alimentazione elettrica ON/OFF o dimmerabile 220-240V integrata. L'apparecchio è installabile su qualsiasi pavimento per mezzo di tasselli. Cassaforma per l'installazione su pavimentazione da gettare con plinto di cemento da ordinare separatamente. Versione 110V a richiesta.

LED light source included. Integrated 220-240V ON/OFF or dimmable electrical power. The device may be installed on any flooring with anchors. Box for installation on flooring laid over concrete sold separately. 110V version upon request.

Power Led: 5W - 447 lm ≠ FIXT 282 lm - 2700K/CRI 80 - 220-240V / 5W - 480 lm ≠ FIXT 303 lm - 3000K/CRI 80 - 220-240V / 5W - 513 lm ≠ FIXT 324 lm - 4000K/CRI 80 - 220-240V

2700K

- Non Dimmable
- F016A23A001
 - F016A23A006
 - F016A23A012
 - F016A23A018
 - F016A23A030
 - F016A23A033
- 1-10V
- F016A23B001
 - F016A23B006
 - F016A23B012
 - F016A23B018
 - F016A23B030
 - F016A23B033
- Dali
- F016A23D001
 - F016A23D006
 - F016A23D012
 - F016A23D018
 - F016A23D030
 - F016A23D033

3000K

- Non Dimmable
- F016A33A001
 - F016A33A006
 - F016A33A012
 - F016A33A018
 - F016A33A030
 - F016A33A033
- 1-10V
- F016A33B001
 - F016A33B006
 - F016A33B012
 - F016A33B018
 - F016A33B030
 - F016A33B033
- Dali
- F016A33D001
 - F016A33D006
 - F016A33D012
 - F016A33D018
 - F016A33D030
 - F016A33D033

4000K

- Non Dimmable
- F016A43A001
 - F016A43A006
 - F016A43A012
 - F016A43A018
 - F016A43A030
 - F016A43A033
- 1-10V
- F016A43B001
 - F016A43B006
 - F016A43B012
 - F016A43B018
 - F016A43B030
 - F016A43B033
- Dali
- F016A43D001
 - F016A43D006
 - F016A43D012
 - F016A43D018
 - F016A43D030
 - F016A43D033

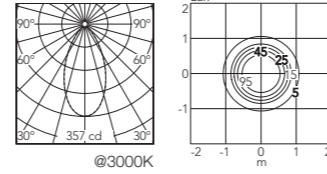

Caule Bollard 3 Nest

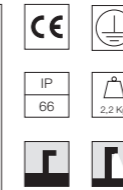
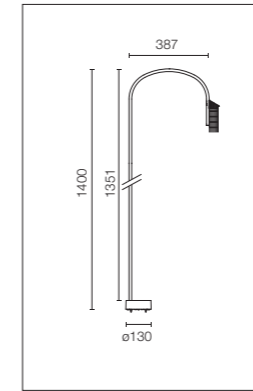

Sorgente luminosa a LED inclusa. Alimentazione elettrica ON/OFF o dimmerabile 220-240V integrata. L'apparecchio è installabile su qualsiasi pavimento per mezzo di tasselli. Cassaforma per l'installazione su pavimentazione da gettare con plinto di cemento da ordinare separatamente. Versione 110V a richiesta.

LED light source included. Integrated 220-240V ON/OFF or dimmable electrical power. The device may be installed on any flooring with anchors. Box for installation on flooring laid over concrete sold separately. 110V version upon request.

Power Led: 5W - 447 lm ≠ FIXT 124 lm - 2700K/CRI 80 - 220-240V / 5W - 480 lm ≠ FIXT 137 lm - 3000K/CRI 80 - 220-240V / 5W - 513 lm ≠ FIXT 143 lm - 4000K/CRI 80 - 220-240V

2700K

- Non Dimmable
- F016B23A001
 - F016B23A006
 - F016B23A012
 - F016B23A018
 - F016B23A030
 - F016B23A033
- 1-10V
- F016B23B001
 - F016B23B006
 - F016B23B012
 - F016B23B018
 - F016B23B030
 - F016B23B033
- Dali
- F016B23D001
 - F016B23D006
 - F016B23D012
 - F016B23D018
 - F016B23D030
 - F016B23D033

3000K

- Non Dimmable
- F016B33A001
 - F016B33A006
 - F016B33A012
 - F016B33A018
 - F016B33A030
 - F016B33A033
- 1-10V
- F016B33B001
 - F016B33B006
 - F016B33B012
 - F016B33B018
 - F016B33B030
 - F016B33B033
- Dali
- F016B33D001
 - F016B33D006
 - F016B33D012
 - F016B33D018
 - F016B33D030
 - F016B33D033

4000K

- Non Dimmable
- F016B43A001
 - F016B43A006
 - F016B43A012
 - F016B43A018
 - F016B43A030
 - F016B43A033
- 1-10V
- F016B43B001
 - F016B43B006
 - F016B43B012
 - F016B43B018
 - F016B43B030
 - F016B43B033
- Dali
- F016B43D001
 - F016B43D006
 - F016B43D012
 - F016B43D018
 - F016B43D030
 - F016B43D033

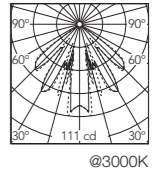

h(m)	E(lx)	D(m)
1	111	0.40
2	28	0.80
3	12	1.20
4	7	1.60
5	4	2.01

Caule: Accessori / Accessories

Dispositivo di protezione per il sovraccarico. 275 Vac. Corrente massima di scarica 10KA (8/29us). Massima corrente operativa 5A. Adatto per la connessione in serie. IP66.

Surge protection device. 275Vac. Maximum discharge current 10KA (8/20us). Maximum operating current 5A. Suitable for series connection. IP66.

F990E00A000

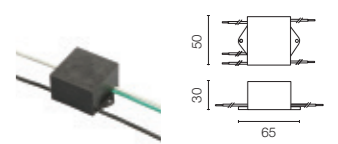

Cassaforma per l'installazione a terra

Box for ground installation.

F016Z000000

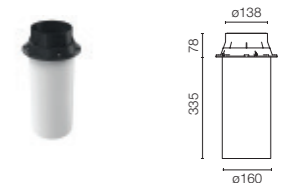

Flauta



Designed by Patricia Urquiola



Flauta Spiga 3



Flauta Spiga 1

Famiglia / Family

Flauta Riga



Power Led

12W
2x347 lm - 2700K/CRI 80
2x372 lm - 3000K/CRI 80
2x398 lm - 4000K/CRI 80

Flauta Spiga



Power Led

12W
2x347 lm - 2700K/CRI 80
2x372 lm - 3000K/CRI 80
2x398 lm - 4000K/CRI 80

Descrizione / Description

Collezione di apparecchi di illuminazione da esterno a parete con emissione luminosa biemissione, disponibili in tre diverse lunghezze.

Gli apparecchi sono caratterizzati dall'incisione superficiale che si declina in due ricercate varianti: Flauta Riga, con incisioni verticali, Flauta Spiga, caratterizzata da una trama obliqua elegante e sofisticata.

Completa l'apparecchio un accessorio deflettore, verniciato secondo la stessa finitura del corpo lampada, installabile a discrezione sulla testa superiore o sulla inferiore, per creare un effetto decorativo di luce riflessa.

Le parti strutturali dell'apparecchio sono realizzate in alluminio trattato con procedimento di conversione chimica al fine di una efficiente resistenza agli agenti atmosferici. Il corpo è verniciato a polvere e disponibile in varie finiture secondo lo standard QUALICOAT. Il primo strato di polvere epossidica dà resistenza chimica e meccanica, il secondo strato di finitura di polvere poliestere assicura resistenza ai raggi UV ed agli agenti atmosferici corrosivi. Le superfici verniciate sono trattate con lavaggi alcalini e acidi, risciacquate con acqua demineralizzata e sottoposte a un trattamento di conversione chimica per proteggere contro l'ossidazione.

Diffusore in vetro trasparente siliconato per garantire l'impermeabilità.

Sorgente luminosa a LED integrata. Driver integrato nel corpo dell'apparecchio per controllo dimmerabile DALI.

Collection of outdoor wall-mounted light fittings with dual light emission, available in various lengths.

The units are characterised by the surface etching in two refined variations: Flauta Riga, with vertical lines, and Fluta Spiga, characterized by an elegant and sophisticated angular pattern.

Rounding out the device is a deflector accessory painted to match the finish of the lamp body. It can be installed as desired on the upper or lower head to create a decorative effect with reflected light.

The structure is made of aluminium treated with a chemical conversion process for effective resistance to atmospheric agents. The powder coating of the body is available in various finishes according to the QUALICOAT standard. The first layer of epoxy powder confers chemical and mechanical resistance. The second layer, a polyester powder finish, ensures resistance to UV rays and corrosive atmospheric agents. The painted surfaces are treated with alkaline and acid washes, rinsed with demineralised water, and subjected to chemical conversion treatment to protect against rust.

Diffuser in transparent glass, sealed to guarantee water resistance.

Integrated LED light source. Driver integrated in the body of the unit for DALI dimmer control.

Colori / Colours



01 White



06 Grey



12 Forest Green



18 Deep Brown



30 Black



33 Anthracite

Flauta Riga 1

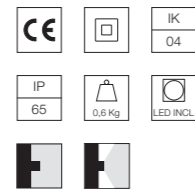
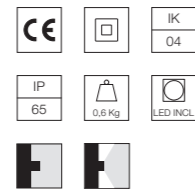
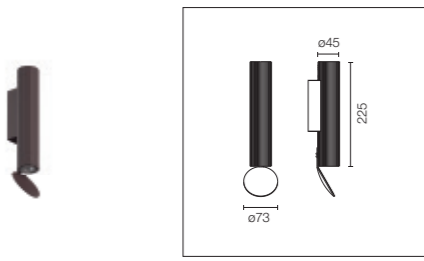

Sorgente luminosa a LED inclusa. Alimentazione elettrica 220-240V dimmerabile DALI integrata. Completa di deflettore per montaggio opzionale sull'emissione superiore o inferiore. Versione 110V a richiesta

LED light source included. Integrated 220-240V electrical power with DALI dimmer. Comes with deflector for optional installation on the upper or lower head. 110V version available by request.

Power Led: 12W - 2x555 lm ≠ FIXT 2x347 lm - 2700K/CRI 80 - 220-240V / 12W - 2x597 lm ≠ FIXT 2x372 lm - 3000K/CRI 80 - 220-240V / 12W - 2x638 lm ≠ FIXT 2x398 lm - 4000K/CRI 80 - 220-240V

2700K

- F019A21D001
- F019A21D006
- F019A21D012
- F019A21D018
- F019A21D030
- F019A21D033

3000K

- F019A31D001
- F019A31D006
- F019A31D012
- F019A31D018
- F019A31D030
- F019A31D033

4000K

- F019A41D001
- F019A41D006
- F019A41D012
- F019A41D018
- F019A41D030
- F019A41D033

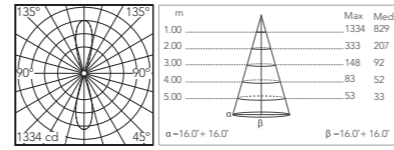

@3000K

Flauta Spiga 1

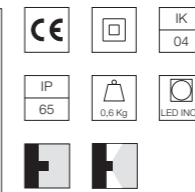
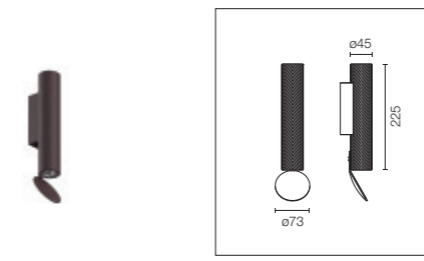

Sorgente luminosa a LED inclusa. Alimentazione elettrica 220-240V dimmerabile DALI integrata. Completa di deflettore per montaggio opzionale sull'emissione superiore o inferiore. Versione 110V a richiesta

LED light source included. Integrated 220-240V electrical power with DALI dimmer. Comes with deflector for optional installation on the upper or lower head. 110V version available by request.

Power Led: 12W - 2x555 lm ≠ FIXT 2x347 lm - 2700K/CRI 80 - 220-240V / 12W - 2x597 lm ≠ FIXT 2x372 lm - 3000K/CRI 80 - 220-240V / 12W - 2x638 lm ≠ FIXT 2x398 lm - 4000K/CRI 80 - 220-240V

2700K

- F019B21D001
- F019B21D006
- F019B21D012
- F019B21D018
- F019B21D030
- F019B21D033

3000K

- F019B31D001
- F019B31D006
- F019B31D012
- F019B31D018
- F019B31D030
- F019B31D033

4000K

- F019B41D001
- F019B41D006
- F019B41D012
- F019B41D018
- F019B41D030
- F019B41D033

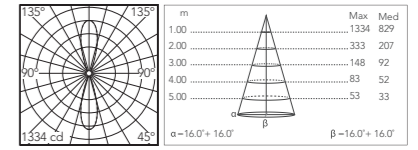

@3000K

Flauta Riga 2

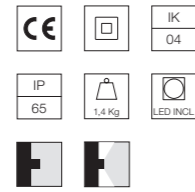
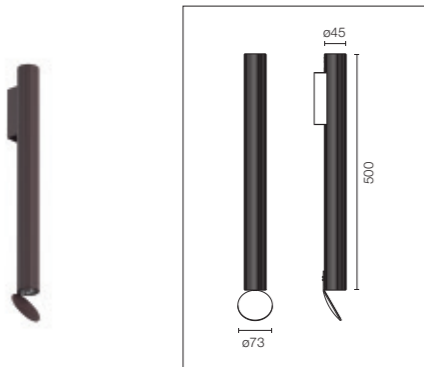

Sorgente luminosa a LED inclusa. Alimentazione elettrica 220-240V dimmerabile DALI integrata. Completa di deflettore per montaggio opzionale sull'emissione superiore o inferiore. Versione 110V a richiesta

LED light source included. Integrated 220-240V electrical power with DALI dimmer. Comes with deflector for optional installation on the upper or lower head. 110V version available by request.

Power Led: 12W - 2x555 lm ≠ FIXT 2x347 lm - 2700K/CRI 80 - 220-240V / 12W - 2x597 lm ≠ FIXT 2x372 lm - 3000K/CRI 80 - 220-240V / 12W - 2x638 lm ≠ FIXT 2x398 lm - 4000K/CRI 80 - 220-240V

2700K

- F019A22D001
- F019A22D006
- F019A22D012
- F019A22D018
- F019A22D030
- F019A22D033

3000K

- F019A32D001
- F019A32D006
- F019A32D012
- F019A32D018
- F019A32D030
- F019A32D033

4000K

- F019A42D001
- F019A42D006
- F019A42D012
- F019A42D018
- F019A42D030
- F019A42D033

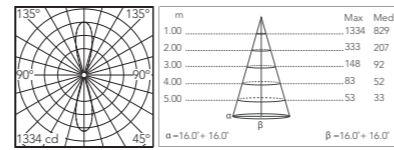

@3000K

Flauta Spiga 2

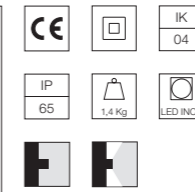
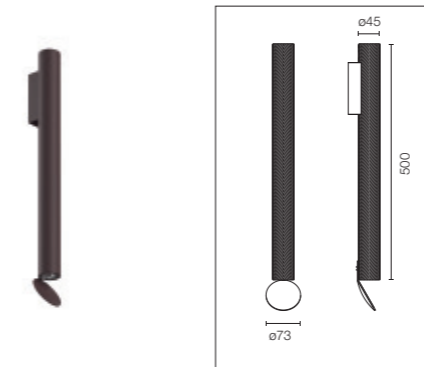

Sorgente luminosa a LED inclusa. Alimentazione elettrica 220-240V dimmerabile DALI integrata. Completa di deflettore per montaggio opzionale sull'emissione superiore o inferiore. Versione 110V a richiesta

LED light source included. Integrated 220-240V electrical power with DALI dimmer. Comes with deflector for optional installation on the upper or lower head. 110V version available by request.

Power Led: 12W - 2x555 lm ≠ FIXT 2x347 lm - 2700K/CRI 80 - 220-240V / 12W - 2x597 lm ≠ FIXT 2x372 lm - 3000K/CRI 80 - 220-240V / 12W - 2x638 lm ≠ FIXT 2x398 lm - 4000K/CRI 80 - 220-240V

2700K

- F019B22D001
- F019B22D006
- F019B22D012
- F019B22D018
- F019B22D030
- F019B22D033

3000K

- F019B32D001
- F019B32D006
- F019B32D012
- F019B32D018
- F019B32D030
- F019B32D033

4000K

- F019B42D001
- F019B42D006
- F019B42D012
- F019B42D018
- F019B42D030
- F019B42D033

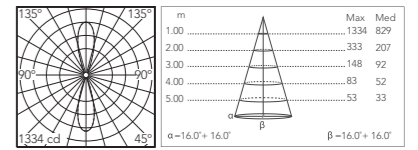

@3000K

Flauta Riga 3

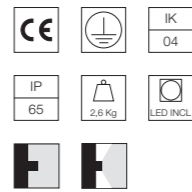
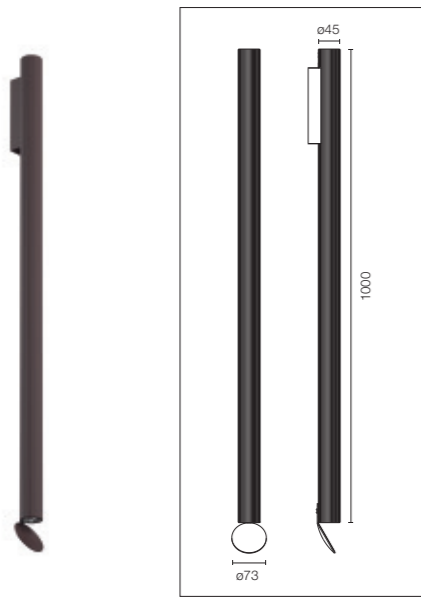

Sorgente luminosa a LED inclusa. Alimentazione elettrica 220-240V dimmerabile DALI integrata. Completa di deflettore per montaggio opzionale sull'emissione superiore o inferiore. Versione 110V a richiesta

LED light source included. Integrated 220-240V electrical power with DALI dimmer. Comes with deflector for optional installation on the upper or lower head. 110V version available by request.

Power Led: 12W - 2x555 lm ≠ FIXT 2x347 lm - 2700K/CRI 80 - 220-240V / 12W - 2x597 lm ≠ FIXT 2x372 lm - 3000K/CRI 80 - 220-240V / 12W - 2x638 lm ≠ FIXT 2x398 lm - 4000K/CRI 80 - 220-240V

2700K

- F019A23D001
- F019A23D006
- F019A23D012
- F019A23D018
- F019A23D030
- F019A23D033

3000K

- F019A33D001
- F019A33D006
- F019A33D012
- F019A33D018
- F019A33D030
- F019A33D033

4000K

- F019A43D001
- F019A43D006
- F019A43D012
- F019A43D018
- F019A43D030
- F019A43D033

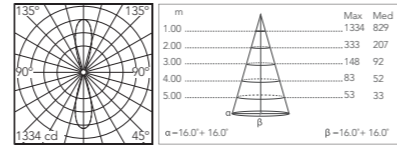

@3000K

Flauta Spiga 3

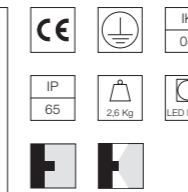
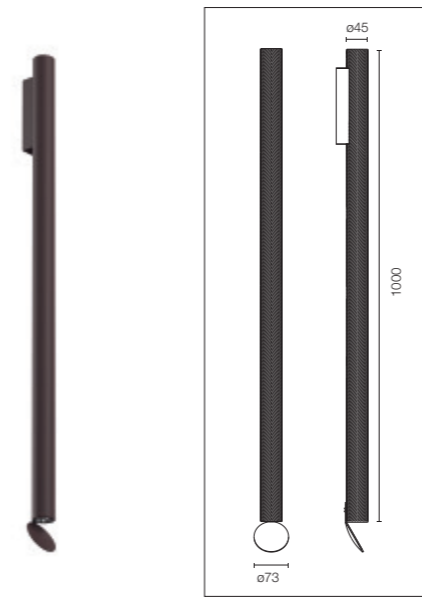

Sorgente luminosa a LED inclusa. Alimentazione elettrica 220-240V dimmerabile DALI integrata. Completa di deflettore per montaggio opzionale sull'emissione superiore o inferiore. Versione 110V a richiesta

LED light source included. Integrated 220-240V electrical power with DALI dimmer. Comes with deflector for optional installation on the upper or lower head. 110V version available by request.

Power Led: 12W - 2x555 lm ≠ FIXT 2x347 lm - 2700K/CRI 80 - 220-240V / 12W - 2x597 lm ≠ FIXT 2x372 lm - 3000K/CRI 80 - 220-240V / 12W - 2x638 lm ≠ FIXT 2x398 lm - 4000K/CRI 80 - 220-240V

2700K

- F019B23D001
- F019B23D006
- F019B23D012
- F019B23D018
- F019B23D030
- F019B23D033

3000K

- F019B33D001
- F019B33D006
- F019B33D012
- F019B33D018
- F019B33D030
- F019B33D033

4000K

- F019B43D001
- F019B43D006
- F019B43D012
- F019B43D018
- F019B43D030
- F019B43D033

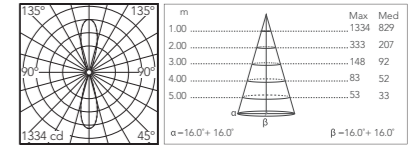

@3000K

Lighting in the Rain

Designed by Philippe Starck





Superarchimoon



Romeo Suspension

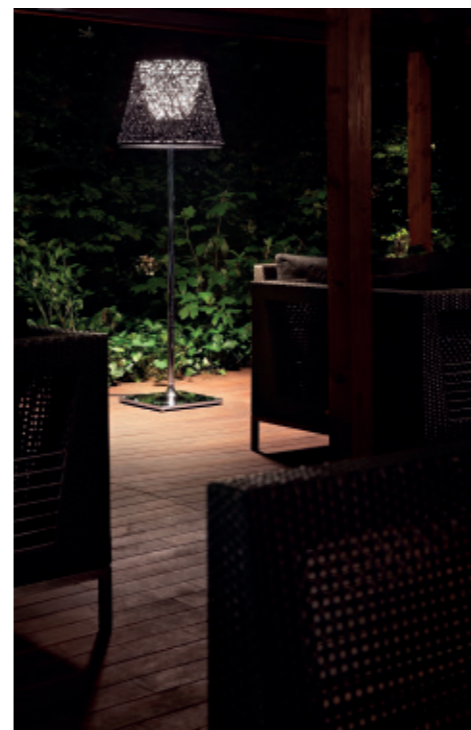

Romeo Floor

Famiglia / Family

Lighting in the Rain



HSGS E27

250W

or

Led

21W

2450 lm - 3000K/CRI 80

Colori / Colours



22 Panama

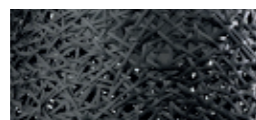

41 Green Wall

Descrizione / Description

KTribe F3 Outdoor

Lampada da terra a luce diffusa per uso esterno. Base e supporto asta in alluminio pressofuso, asta in alluminio estruso.

Le parti strutturali dell'apparecchio vengono trattate con procedimento di conversione chimica al fine di una efficiente resistenza agli agenti atmosferici. Finitura cromo. Diffusore interno e supporto portalampada in policarbonato stampato ad iniezione. Diffusore esterno ottenuto mediante intrecci di tubolari di PVC colorato, telaio interno in barre di alluminio e verniciato poliestere. Contrappeso in acciaio trattato mediante procedimento di cataforesi, sempre per garantire una efficiente resistenza agli agenti atmosferici. Cover diffusore esterno in alluminio pressofuso verniciato.

Romeo C3 Outdoor

Apparecchio di illuminazione da esterno per installazioni a plafone, a luce diretta e diffusa. Diffusore esterno ottenuto mediante intrecci di tubolari di PVC colorato, su telaio interno in tubolare di alluminio verniciato poliestere. Diffusore interno in policarbonato termoformato sottovuoto di colore opal e rimovibile dall'utente, senza l'uso di attrezzi per la sostituzione della lampada. Supporto diffusore in lega di alluminio pressofuso, anodizzato e verniciato di colore grigio a liquido. Attacco a plafone in lega di alluminio presso fusa con finitura brillantata. Rosone di copertura in policarbonato (PC) stampato ad iniezione. Stelo in acciaio INOX lega 316L – lucidato. Al fine di una efficiente resistenza agli agenti atmosferici, tutti i particolari verniciati vengono trattati con procedimento di conversione chimica anticorrosione.

Superarchimoon Outdoor

Lampada da terra per esterni a luce diretta e diffusa. Diffusore esterno ottenuto mediante intrecci di tubolari di PVC colorato, su telaio interno in tubolare di alluminio verniciato poliestere. Diffusore interno in policarbonato opale stampato ad iniezione.

Le parti strutturali dell'apparecchio (sostegno base, supporto diffusori, bracci, forcelle, leve e tiranti) vengono trattate con procedimento di conversione chimica al fine di una efficiente resistenza agli agenti atmosferici. Il corpo è verniciato di colore grigio. Le molle e le principali componenti meccaniche dell'apparecchio sono realizzate in materiali specifici sempre per una efficiente resistenza agli agenti atmosferici.

L'apparecchio non prevede alcun sistema per le funzioni ON/OFF e la regolazione del flusso luminoso ma presenta un cavo di alimentazione bipolare trasparente di lunghezza utile 10 metri. L'apparecchio è dotato inoltre di scatola di derivazione per un cablaggio adatto alle applicazioni per esterno.

Si raccomanda l'uso di un sistema di connessione con un grado di protezione maggiore o uguale al grado di protezione dell'apparecchio.

KTribe F3 Outdoor

Floor lamp emitting diffused light for outdoor use. Die-cast aluminum base and pole support. Chemical conversion treatment of the structural parts to enhance their resistance to atmospheric agents. Chrome finish. Injection-molded polycarbonate internal diffuser and bulb-holder. External diffuser made from braided colored PVC tubes and inner frame from polyester-painted aluminum tubes. Steel cataphoresis treated counterweight for effective weather resistance. Painted die-cast aluminum external diffuser cover.

Romeo C3 Outdoor

Suspension luminaire for outdoor use providing direct and diffused light. External diffuser obtained from braided colored PVC tubes, internal frame in polyester-painted aluminum tubes. Inner diffuser in opal-colored, vacuum-formed polycarbonate which is removable for bulb change without the use of tools. Diffuser support in anodized die-cast aluminum alloy, liquid grey painted. Die-cast aluminum alloy ceiling fitting with polished finish. Injection-molded polycarbonate (PC) cover rose. 316L stainless steel pole – polished.

In order to obtain good weather resistance, all the painted details have undergone a chemical conversion treatment for enhanced corrosion resistance.

Superarchimoon Outdoor

Floor lamp for outdoor use providing direct and diffused light. External diffuser obtained from braided colored PVC tubes, internal frame in polyester-painted aluminum tubular. Internal diffuser in injection-molded opal polycarbonate.

The structural parts of the luminaire (base support, diffusers support, arms, brackets, levers and tie rods) have been treated with a chemical conversion for enhanced weather resistance. The body is painted in grey. Springs and main mechanical components are also made with special materials for good weather resistance.

The luminaire has no ON/OFF switch or luminous flux adjustment, but has a 10 mt transparent bipolar feeding cord. The luminaire also is equipped with a junction box suitable for outdoor applications.

We recommend using a connection system with a higher or equal protection degree than the one of the luminaire.

Romeo Outdoor C3 Pvc 710 mm

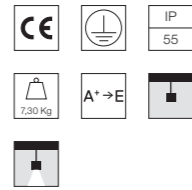
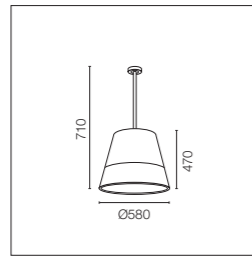

Sorgente luminosa esclusa.

Light source not included.

HSGS E27: 1x250W or **1 LED:** 21W - 2450 lm - 3000K

- F6468022
- F6468041

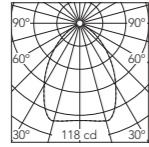

Beam Angle: 78°		
h(m)	E(lx)	D(m)
1	118	1.63
2	30	3.26
3	13	4.89
4	7	6.53
5	5	8.16

Panama

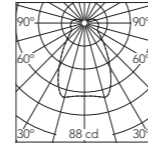

Beam Angle: 74°		
h(m)	E(lx)	D(m)
1	88	1.50
2	22	3.01
3	10	4.51
4	6	6.02
5	4	7.52

Green Wall

Accessori / Accessories

1 x LED 21W E27 2450lm 3000K cod. RF26998 [e] DIMMER

Romeo Outdoor C3 Pvc 910 mm

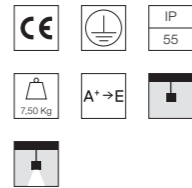
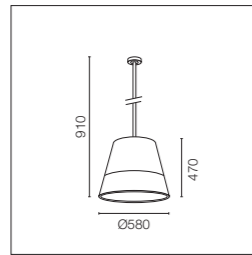

Sorgente luminosa esclusa.

Light source not included.

HSGS E27: 1x250W or **1 LED:** 21W - 2450 lm - 3000K

- F6469022
- F6469041

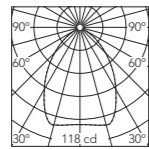

Beam Angle: 78°		
h(m)	E(lx)	D(m)
1	118	1.63
2	30	3.26
3	13	4.89
4	7	6.53
5	5	8.16

Panama

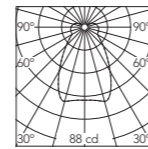

Beam Angle: 74°		
h(m)	E(lx)	D(m)
1	88	1.50
2	22	3.01
3	10	4.51
4	6	6.02
5	4	7.52

Green Wall

Accessori / Accessories

1 x LED 21W E27 2450lm 3000K cod. RF26998 [e] DIMMER

KTribe F3 Outdoor

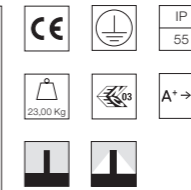
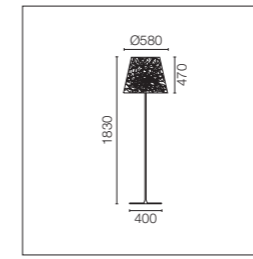

Sorgente luminosa esclusa.

Light source not included.

HSGS E27: 1x250W or **1 LED:** 21W - 2450 lm - 3000K Dimming

- F6268022
- F6268041

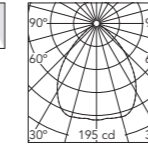

Beam Angle: 85°		
h(m)	E(lx)	D(m)
1	195	1.82
2	49	3.64
3	22	5.46
4	12	7.28
5	8	9.10

Panama

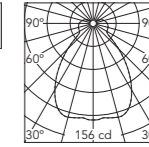

Beam Angle: 82°		
h(m)	E(lx)	D(m)
1	156	1.74
2	39	3.49
3	17	5.23
4	10	6.98
5	6	8.72

Green Wall

Accessori / Accessories

1 x LED 21W E27 2450lm 3000K cod. RF26998 [e] DIMMER

Superarchimoon Outdoor

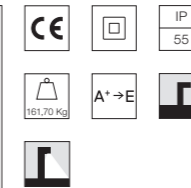
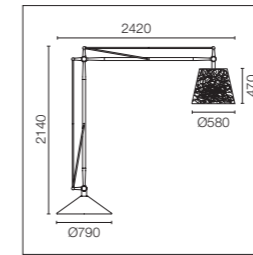

Sorgente luminosa esclusa.

Light source not included.

HSGS E27: 1x250W or **1 LED:** 21W - 2450 lm - 3000K

- F6367022
- F6367041

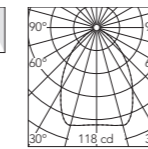

Beam Angle: 78°		
h(m)	E(lx)	D(m)
1	118	1.63
2	30	3.26
3	13	4.89
4	7	6.53
5	5	8.16

Panama

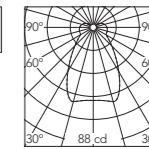

Beam Angle: 74°		
h(m)	E(lx)	D(m)
1	88	1.50
2	22	3.01
3	10	4.51
4	6	6.02
5	4	7.52

Green Wall

Accessori / Accessories

1 x LED 21W E27 2450lm 3000K cod. RF26998 [e] DIMMER

Landlord



Designed by Piero Lissoni



Landlord Ground



Landlord Soft



Landlord Spot + Pole

Famiglia / Family

Landlord Spot



Landlord Spot + Pole



Power Led

2,3W
130 lm - 2700K/CRI 80
135 lm - 3000K/CRI 80
140 lm - 4000K/CRI 80

Spot Optic Power Led

3,4W
135 lm - 2700K/CRI 80
140 lm - 3000K/CRI 80
145 lm - 4000K/CRI 80

Medium Optic Power Led

7,2W
442 lm - 2700K/CRI 80
457 lm - 3000K/CRI 80
492 lm - 4000K/CRI 80

Landlord Soft



Power Led

5W
242 lm - 2700K/CRI 80
252 lm - 3000K/CRI 80
269 lm - 4000K/CRI 80

Landlord Ground



Power Led

2,3W
121 lm - 2700K/CRI 80
125 lm - 3000K/CRI 80
130 lm - 4000K/CRI 80

Power Led

3,4W
183 lm - 2700K/CRI 80
189 lm - 3000K/CRI 80
196 lm - 4000K/CRI 80

Colori / Colours

Landlord Spot / Soft



01 White



06 Grey



12 Forest Green



18 Deep Brown



30 Black



33 Anthracite



71 Anodized Black

Landlord Ground



56 Matt Stainless Steel

Descrizione / Description

Landlord Spot

Proiettore IP65 per uso esterno composto da un corpo in alluminio tornito e alimentato a 24V, disponibile con temperature di colore da 2700K, 3000K e 4000K. Sull'asse orizzontale è possibile orientare il faretto di 359°, sull'asse verticale fino a 30° verso il basso e fino a 90° verso l'alto. I faretti Landlord sono disponibili in due dimensioni, con testa ø40 e ø50, entrambe dotate di ghiera anteriore smontabile, per installare lenti flood oppure fino a due honeycomb per il massimo comfort visivo.

I faretti Landlord possono essere installati su picchetti per terreni rigidi, con la possibilità di un picchetto opzionale, su base in muratura, oppure sull'innovativa cintura per alberi, progettata per fissare l'apparecchio d'illuminazione direttamente ai rami delle piante.

Landlord Soft

Proiettore IP65 per uso esterno, progettato per offrire una luce diffusa.

È caratterizzato da una testa a forma di disco in alluminio, con un fascio orientabile fino a 20° e bloccabile nella posizione desiderata; da alimentare a 24V e disponibile con temperature di colore da 2700K, 3000K e 4000K.

È lo strumento perfetto per illuminare siepi, aiuole e aree di transito con un fascio di luce diffusa omogenea.

Landlord Soft può essere installato su picchetti per terreni rigidi, con la possibilità di un picchetto opzionale.

Landlord Ground

Apparecchi d'illuminazione IP67 da incasso a terra, alimentato a 24V. Corpo in alluminio anodizzato e poi resinato, anello esterno in acciaio inossidabile pallinato, che contiene tutta l'elettronica di controllo. Testa disponibile in due dimensioni, ø49 mm e ø64 mm, con emissione frontale o radente (uno, due o quattro fasci).

Le versioni a emissione frontale sono disponibili con ottica spot o media, o con honeycomb integrato non rimovibile, per un comfort visibile massimo.

Da installare mediante la propria scatola d'installazione.

Landlord Spot

IP65 projector for external use made of turned aluminium body and powered at 24V, and available in 2700K, 3000K and 4000K colour temperatures. With reference to the horizontal axis the spotlight can be swivelled by 359°, on the vertical axis by up to 30° down and up to 90° up.

Landlord Spots are available in two sizes, ø40 and ø50 head, both equipped with desmontable front ferrule, in order to install flood lens or up to two honeycombs for maximum visual confort.

Landlord Spots can be installed on solid ground spikes, with the possibility of an optional picket, on wall base, or on the innovative tree belt, designed to fix the luminaries directly on tree branches.

Landlord Soft

IP65 projector for external use, designed to offer diffuse lighting.

It is characterized by an aluminium disk shape head, orientable up to 20° beam and lockable in position, to be powered at 24V, and available in 2700K, 3000K and 4000K colour temperature.

It is the perfect tool to light bushes, flowerbed and transit areas with an homogenous diffuse light beam.

Landlord Soft can be installed on solid ground spikes, with the possibility of an optional picket.

Landlord Ground

IP67 luminaries for ground recessed installation, powered 24V. Body in anodized, then resined aluminium, external ring in shot-peened stainless steel, encasing the entire control electronics. Head available in two sizes, ø49 mm, and ø64 mm, with frontal or grazing emission (one, two or four beams).

Frontal emission version are available with spot or medium optic, or with integrated non removable honeycomb, for maximum visual confort.

To be installed in its installation box.

Landlord Spot Ø40

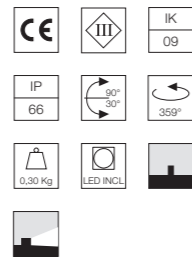
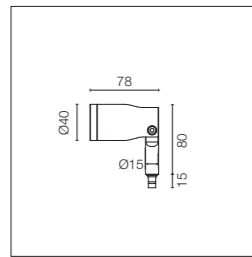

Testa del faretto orientabile per l'installazione su paletti a terra o su base in muratura. I paletti e la base devono essere ordinati come accessori separati. Le teste sono dotate di una ghiera smontabile, per inserire lenti flood o fino a due honeycomb (da ordinare come accessori separati). Alimentazione elettrica remota 24V da ordinare separatamente. Ogni testa è dotata di un segmento di cavo in uscita da 2000 mm e kit di cablaggio.

Spot adjustable head for installation on ground poles or on wall base. Poles and base to be ordered as separated accessories. Heads are equipped with a dismantlable ferrule, to insert flood lens or up to two honeycombs, (to be ordered as separate accessories). 24V remote power supply to be ordered separately. Each head comes with a 2000 mm length outgoing cable and a wiring kit.

Optic Spot 12°

Power Led: 2,3W - 188 lm ≠ *FIXT 130 lm - 2700K/CRI 80 - 24V / 2,3W - 195 lm ≠ *FIXT 135 lm - 3000K/CRI 80 - 24V / 2,3W - 202 lm ≠ *FIXT 140 lm - 4000K/CRI 80 - 24V

2700K

- PWM Dimmable
- F004D21A001
 - F004D21A006
 - F004D21A012
 - F004D21A018
 - F004D21A030
 - F004D21A033
 - F004F21A071

3000K

- PWM Dimmable
- F004D31A001
 - F004D31A006
 - F004D31A012
 - F004D31A018
 - F004D31A030
 - F004D31A033
 - F004F31A071

4000K

- PWM Dimmable
- F004D41A001
 - F004D41A006
 - F004D41A012
 - F004D41A018
 - F004D41A030
 - F004D41A033
 - F004F41A071

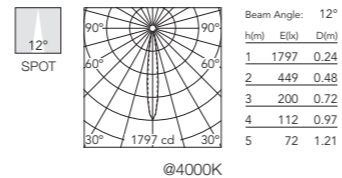

Optic Medium 34°

Power Led: 2,3W - 188 lm ≠ *FIXT 122 lm - 2700K/CRI 80 - 24V / 2,3W - 195 lm ≠ *FIXT 127 lm - 3000K/CRI 80 - 24V / 2,3W - 202 lm ≠ *FIXT 131lm - 4000K/CRI 80 - 24V

2700K

- PWM Dimmable
- F004D22A001
 - F004D22A006
 - F004D22A012
 - F004D22A018
 - F004D22A030
 - F004D22A033
 - F004F22A071

3000K

- PWM Dimmable
- F004D32A001
 - F004D32A006
 - F004D32A012
 - F004D32A018
 - F004D32A030
 - F004D32A033
 - F004F32A071

4000K

- PWM Dimmable
- F004D42A001
 - F004D42A006
 - F004D42A012
 - F004D42A018
 - F004D42A030
 - F004D42A033
 - F004F42A071

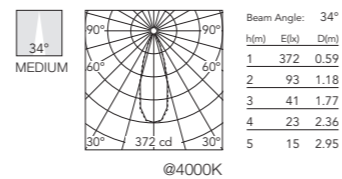

* Numero massimo di apparecchi per alimentatore / Maximum number of luminaires per power supply.

Numero massimo di apparecchi per alimentatore (Vin220÷240). Dati indicativi da verificare con le specifiche condizioni di installazione.	Maximum number of luminaires per power supply. (220÷240 V). These data must be checked taking into account the specific installation conditions.	Non Dimmable	Dimmable
Acc. RF25754	3	Acc. F990B02A000	13
Acc. RF25748	3	Acc. F990B03A000	13
Acc. RF25747	4	Acc. F990B04A000	28
Acc. RF25757	4	Acc. F990B05A000	28
Acc. F990B23AZ00	12		
Acc. RF25755	17		
Acc. RF25749	27		

Landlord Spot Ø50

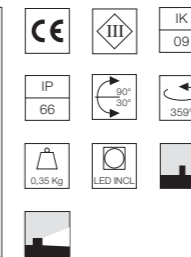
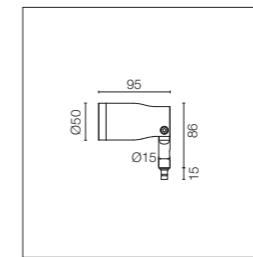

Testa del faretto orientabile per l'installazione su paletti a terra o su base in muratura. I paletti e la base devono essere ordinati come accessori separati. Le teste sono dotate di una ghiera smontabile, per inserire lenti flood o fino a due honeycomb (da ordinare come accessori separati). Alimentazione elettrica remota 24V da ordinare separatamente. Ogni testa è dotata di un segmento di cavo in uscita da 2000 mm e kit di cablaggio.

Spot adjustable head for installation on ground poles or on wall base. Poles and base to be ordered as separated accessories. Heads are equipped with a dismantlable ferrule, to insert flood lens or up to two honeycombs, (to be ordered as separate accessories). 24V remote power supply to be ordered separately. Each head comes with a 2000 mm length outgoing cable and a wiring kit.

Optic Narrow Spot 7°

Power Led: 3,4W - 251 lm ≠ FIXT 135 lm - 2700K/CRI 80 - 24V / 3,4W - 260 lm ≠ FIXT 140 lm - 3000K/CRI 80 - 24V / 3,4W - 270 lm ≠ FIXT 145 lm - 4000K/CRI 80 - 24V

2700K

- PWM Dimmable
- F004E21A001
 - F004E21A006
 - F004E21A012
 - F004E21A018
 - F004E21A030
 - F004E21A033
 - F004G21A071

3000K

- PWM Dimmable
- F004E31A001
 - F004E31A006
 - F004E31A012
 - F004E31A018
 - F004E31A030
 - F004E31A033
 - F004G31A071

4000K

- PWM Dimmable
- F004E41A001
 - F004E41A006
 - F004E41A012
 - F004E41A018
 - F004E41A030
 - F004E41A033
 - F004G41A071

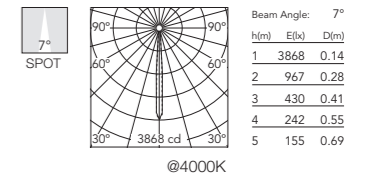

* Numero massimo di apparecchi per alimentatore / Maximum number of luminaires per power supply.

Numero massimo di apparecchi per alimentatore (Vin220÷240). Dati indicativi da verificare con le specifiche condizioni di installazione.	Maximum number of luminaires per power supply. (220÷240 V). These data must be checked taking into account the specific installation conditions.	Non Dimmable	Dimmable
Acc. RF25754	1	Acc. F990B02A000	7
Acc. RF25748	1	Acc. F990B03A000	7
Acc. RF25747	3	Acc. F990B04A000	17
Acc. RF25757	3	Acc. F990B05A000	17
Acc. F990B23AZ00	7		
Acc. RF25755	9		
Acc. RF25749	17		

Optic Medium 24°

Power Led: 7,2W - 666 lm ≠ FIXT 442 lm - 2700K/CRI 80 - 24V / 7,2W - 689 lm ≠ FIXT 457 lm - 3000K/CRI 80 - 24V / 7,2W - 741 lm ≠ FIXT 492 lm - 4000K/CRI 80 - 24V

2700K

- PWM Dimmable
- F004E22A001
 - F004E22A006
 - F004E22A012
 - F004E22A018
 - F004E22A030
 - F004E22A033
 - F004G22A071

3000K

- PWM Dimmable
- F004E32A001
 - F004E32A006
 - F004E32A012
 - F004E32A018
 - F004E32A030
 - F004E32A033
 - F004G32A071

4000K

- PWM Dimmable
- F004E42A001
 - F004E42A006
 - F004E42A012
 - F004E42A018
 - F004E42A030
 - F004E42A033
 - F004G42A071

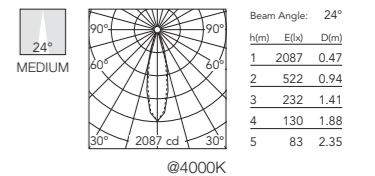

* Numero massimo di apparecchi per alimentatore / Maximum number of luminaires per power supply.

Numero massimo di apparecchi per alimentatore (Vin220÷240). Dati indicativi da verificare con le specifiche condizioni di installazione.	Maximum number of luminaires per power supply. (220÷240 V). These data must be checked taking into account the specific installation conditions.	Non Dimmable	Dimmable
Acc. RF25754	1	Acc. F990B02A000	3
Acc. RF25748	1	Acc. F990B03A000	3
Acc. RF25747	1	Acc. F990B04A000	7
Acc. RF25757	1	Acc. F990B05A000	7
Acc. F990B23AZ00	3		
Acc. RF25755	6		
Acc. RF25749	9		

Landlord Spot: Testa + accessorio paletto / Head + pole accessory

Spot Ø40

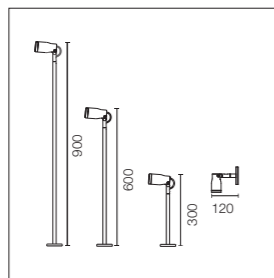

Paletto con base.
Pronta per l'installazione su superficie solida.
Per l'installazione a terra, completare con il picchetto da ordinare separatamente.

Pole with base.
Ready for installation on solid surface.
Ground installation needs earth stick use, to be ordered as separated item.

H 300 mm

- F004Z010001
- F004Z010006
- F004Z010012
- F004Z010018
- F004Z010030
- F004Z010033
- F004Z0D0071

H 600 mm

- F004Z020001
- F004Z020006
- F004Z020012
- F004Z020018
- F004Z020030
- F004Z020033
- F004Z0E0071

H 900 mm

- F004Z030001
- F004Z030006
- F004Z030012
- F004Z030018
- F004Z030030
- F004Z030033
- F004Z0F0071



Spot Ø50

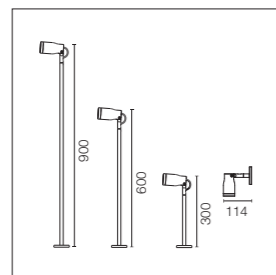

Landlord Spot: Accessori / Accessories

Base da parete.

Wall base.

- F004Z040001
- F004Z040006
- F004Z040012
- F004Z040018
- F004Z040030
- F004Z040033
- F004Z0A0071



Picchetto.

Earth stick.

Da montare sui paletti con base.

To be mounted on poles with base.

F004Z060000



Honeycomb.

Honeycomb.

Landlord Spot Ø40
F004Z0B0000
Landlord Spot Ø50
F004Z0L0000



Lente flood.

Flood lens.

Landlord Spot Ø40
F004Z0C0000
Landlord Spot Ø50
F004Z0H0000



Cinghia per alberi.

Tree strap.

Accessorio per installazione spot direttamente sul ramo di un albero, da ø30 mm fino a ø100 mm.
Finitura Deep Brown.

Accessorio for spot installation directly on tree branch, from ø30mm up to ø100mm.
Deep Brown finishing.

F004Z070000



Landlord Soft

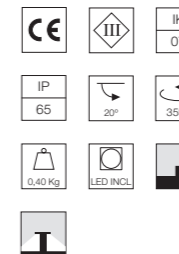
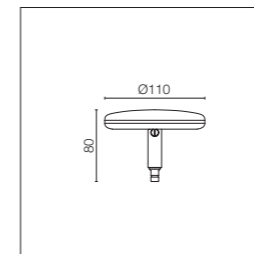

Testa orientabile a 20° per l'installazione su paletti a terra. I paletti devono essere ordinati come accessori separati. Alimentazione elettrica 24V da ordinare separatamente. Ogni testa è dotata di un segmento di cavo in uscita da 2000 mm e kit di cablaggio.

20° adjustable head for installation on ground poles. Poles to be ordered as separated accessories. 24V remote power supply to be ordered separately. Each head comes with a 2000 mm length outgoing cable and a wiring kit.

Top Led: 5W - 379 lm ≠ FIXT 242 lm - 2700K/CRI 80 - 24V / 5W - 395 lm ≠ FIXT 252 lm - 3000K/CRI 80 - 24V / 5W - 421 lm ≠ FIXT 269 lm - 4000K/CRI 80 - 24V

2700K

PWM Dimmable

- F004C20A001
- F004C20A006
- F004C20A012
- F004C20A018
- F004C20A030
- F004C20A033
- F004H20A071

3000K

PWM Dimmable

- F004C30A001
- F004C30A006
- F004C30A012
- F004C30A018
- F004C30A030
- F004C30A033
- F004H30A071

4000K

PWM Dimmable

- F004C40A001
- F004C40A006
- F004C40A012
- F004C40A018
- F004C40A030
- F004C40A033
- F004H40A071

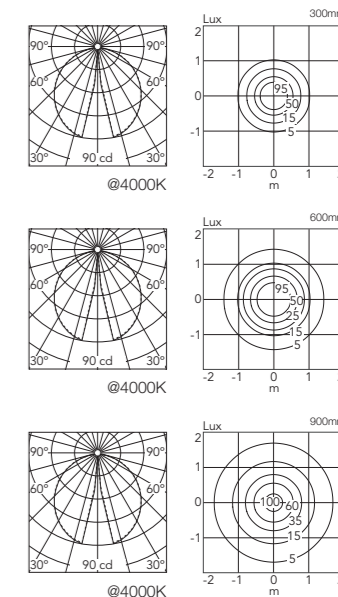

* Numero massimo di apparecchi per alimentatore / Maximum number of luminaires per power supply.

Numero massimo di apparecchi per alimentatore (Vin220÷240). Dati indicativi da verificare con le specifiche condizioni di installazione.	Maximum number of luminaires per power supply. (220÷240 V). These data must be checked taking into account the specific installation conditions.	Non Dimmable		Dimmable	
		Acc. RF25754	1	Acc. F990B02A000	5
		Acc. RF25748	1	Acc. F990B03A000	5
		Acc. RF25747	1	Acc. F990B04A000	12
		Acc. RF25757	1	Acc. F990B05A000	12
		Acc. F990B23AZ00	3		
		Acc. RF25755	6		
		Acc. RF25749	9		

Landlord Soft: Testa + accessorio paletto / Head + pole accessory

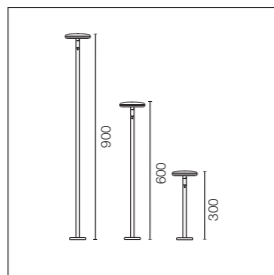

Paletto con base.
Pronta per l'installazione su superficie solida.
Per l'installazione a terra, completare con il picchetto da ordinare separatamente.



Pole with base.
Ready for installation on solid surface.
Ground installation needs earth stick use, to be ordered as separated item.

H 300 mm

- F004Z010001
- F004Z010006
- F004Z010012
- F004Z010018
- F004Z010030
- F004Z010033
- F004Z0D0071

H 600 mm

- F004Z020001
- F004Z020006
- F004Z020012
- F004Z020018
- F004Z020030
- F004Z020033
- F004Z0E0071

H 900 mm

- F004Z030001
- F004Z030006
- F004Z030012
- F004Z030018
- F004Z030030
- F004Z030033
- F004Z0F0071

Landlord Soft: Accessori / Accessories

Picchetto. Da montare sui paletti con base.	Earth stick. To be mounted on poles with base.	F004Z060000	
Sistema di giunzione IP68 H2O Stop anti-condensa a 3/4 vie 4 poli. (Ø5,5÷12mm cavo).	3/4 way terminal block 4 poles IP68 H2O Stop. (ø5,5÷12mm cable).	F990C010000	
Sistema di giunzione IP68 H2O Stop anti-condensa a 2 vie 4 poli. (Ø5,5÷12mm cavo).	2 way terminal block 4 poles IP68 H2O Stop. (ø5,5÷12mm cable).	F990C00A000	
Alimentatore per installazione remota 24Vdc 20W / 110-240Vdc (15W@110V) IP67 Classe II selv.	Power supply for remote installation 24Vdc 20W / 110-240Vdc (15W@110V) IP67 Class II selv.	Landlord Soft Only for Dali version RF26387	

Esempi di Configurazione / Examples of Configuration

ON-OFF (non dimmerabile) = codice prodotto (F004C30A001 + F004Z010001) + alimentatore 8W / 110-240Vac / 24Vdc ON-OFF IP65 (RF25748)
ON-OFF (non dimmable) = luminaire code (F004C30A001 + F004Z010001) + power supply 8W / 110-240Vac / 24Vdc ON-OFF IP65 (RF25748)

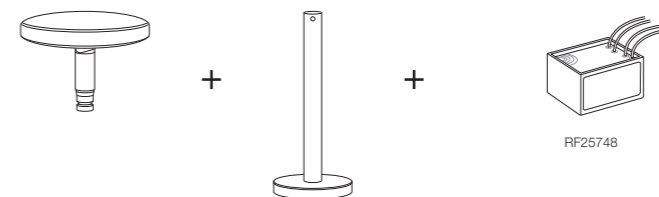

Dimmerabile 1-10V = codice prodotto (F004C30A001 + F004Z010001) + alimentatore 35W / 120-270Vac / 24Vdc 1-10V PWM control IP67 (F990B02A000)
Dimmable 1-10V = luminaire code (F004C30A001 + F004Z010001) + power supply 35W / 120-270Vac / 24Vdc 1-10V PWM control IP67 (F990B02A000)

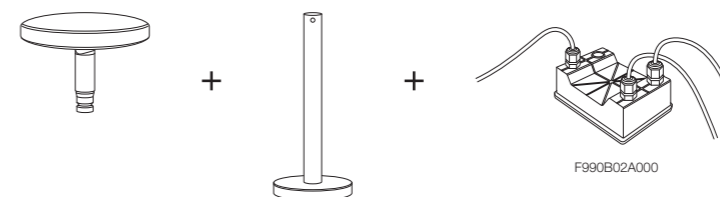

Dimmerabile 1-10V: interfaccia PWM + alimentatore = codice prodotto (F004C30A001 + F004Z010001) + interfaccia di controllo 1-10V PWM 24Vdc 120W IP67 (F990B00A000) + alimentatore 8W / 110-240Vac / 24Vdc ON-OFF IP65 (RF25748) o altro alimentatore remoto 24Vdc

Dimmable 1-10V : PWM control interface + power supply = luminaire code (F004C30A001 + F004Z010001) + PWM control interface 1-10V PWM 24Vdc 120W IP67 (F990B00A000) + power supply 8W / 110-240Vac / 24Vdc ON-OFF IP65 (RF25748) or other remote power supply

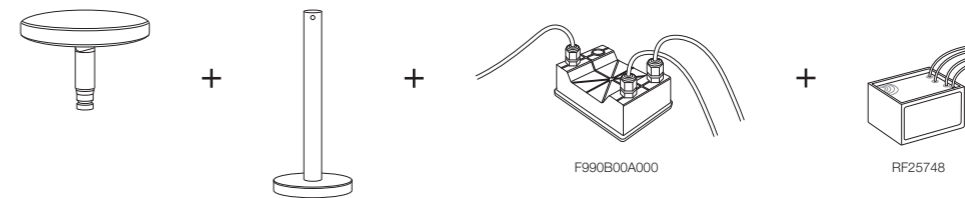

Dimmerabile DALI = codice prodotto (F004C30A001 + F004Z010001) + alimentatore 35W / 120-270Vac / 24Vdc DALI PWM control IP67 (F990B03A000)
Dimmable DALI = luminaire code (F004C30A001 + F004Z010001) + power supply 35W / 120-270Vac / 24Vdc DALI PWM control IP67 (F990B03A000)

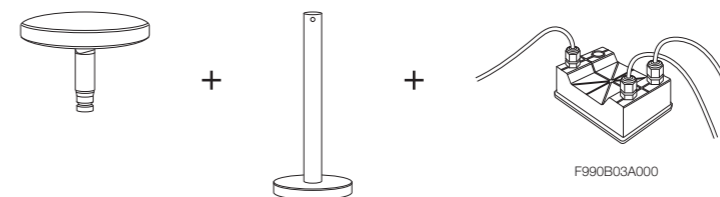

Dimmerabile DALI: interfaccia PWM + alimentatore = codice prodotto (F004C30A001 + F004Z010001) + interfaccia di controllo DALI PWM 24Vdc 120W IP67 (F990B01A000) + alimentatore 8W / 110-240Vac / 24Vdc ON-OFF IP65 (RF25748) o altro alimentatore remoto 24Vdc

Dimmable DALI: PWM control interface + power supply = luminaire code (F004C30A001 + F004Z010001) + PWM control interface DALI PWM 24Vdc 120W IP67 (F990B01A000) + power supply 8W / 110-240Vac / 24Vdc ON-OFF IP65 (RF25748) or other remote power supply

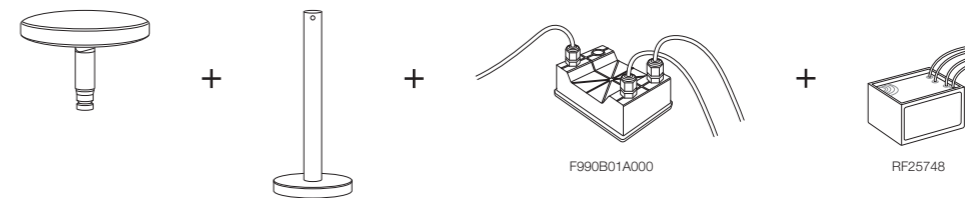

Landlord Ground 49

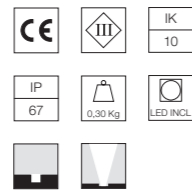
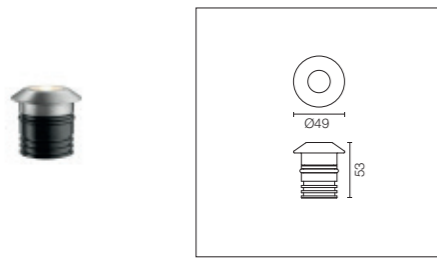

Alimentazione elettrica remota 24V da ordinare separatamente. Necessaria cassaforma per installazione, da ordinare separatamente.

24V remote power supply to be ordered separately. Necessary box for installation, to be ordered separately.

Power Led: 2,3W - 188 lm ≠ *FIXT 121 lm - 2700K/CRI 80 - 24V / 2,3W - 195 lm ≠ *FIXT 125 lm - 3000K/CRI 80 - 24V / 2,3W - 202 lm ≠ *FIXT 130 lm - 4000K/CRI 80 - 24V
*FIXT lm = Spot Optic

Optic Spot 14°

2700K

- Non Dimmable
- F004A21A056
- PWM Dimmable
- F004A21H056
- Non Dimmable with honeycomb
- F004A26A05601

3000K

- Non Dimmable
- F004A31A056
- PWM Dimmable
- F004A31H056
- Non Dimmable with honeycomb
- F004A36A05601

4000K

- Non Dimmable
- F004A41A056
- PWM Dimmable
- F004A41H056
- Non Dimmable with honeycomb
- F004A46A05601

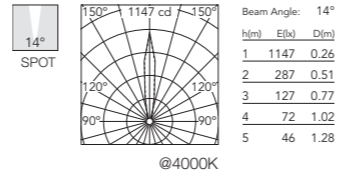

Optic Medium 40°

2700K

- Non Dimmable
- F004A22A056
- PWM Dimmable
- F004A22H056
- Non Dimmable with honeycomb
- F004A27A05602

3000K

- Non Dimmable
- F004A32A056
- PWM Dimmable
- F004A32H056
- Non Dimmable with honeycomb
- F004A37A05602

4000K

- Non Dimmable
- F004A42A056
- PWM Dimmable
- F004A42H056
- Non Dimmable with honeycomb
- F004A47A05602

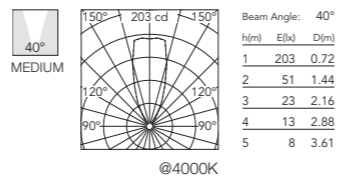

Landlord Ground 49 1 Beam

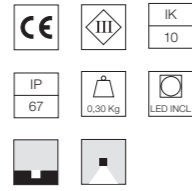
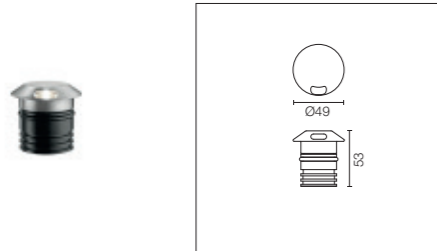

Alimentazione elettrica remota 24V da ordinare separatamente. Necessaria cassaforma per installazione, da ordinare separatamente.

24V remote power supply to be ordered separately. Necessary box for installation, to be ordered separately.

Power Led: 2,3W - 188 lm ≠ FIXT 8 lm - 2700K/CRI 80 - 24V / 2,3W - 195 lm ≠ FIXT 9 lm - 3000K/CRI 80 - 24V / 2,3W - 202 lm ≠ FIXT 9 lm - 4000K/CRI 80 - 24V

2700K

- Non Dimmable
- F004A23A056
- PWM Dimmable
- F004A23H056

3000K

- Non Dimmable
- F004A33A056
- PWM Dimmable
- F004A33H056

4000K

- Non Dimmable
- F004A43A056
- PWM Dimmable
- F004A43H056

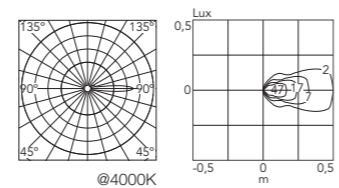

Landlord Ground 49 2 Beams

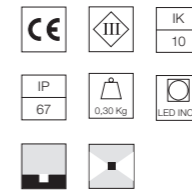
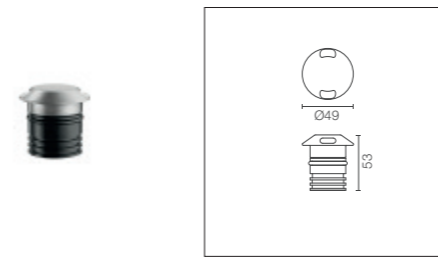

Alimentazione elettrica remota 24V da ordinare separatamente. Necessaria cassaforma per installazione, da ordinare separatamente.

24V remote power supply to be ordered separately. Necessary box for installation, to be ordered separately.

Power Led: 2,3W - 188 lm ≠ FIXT 16 lm - 2700K/CRI 80 - 24V / 2,3W - 195 lm ≠ FIXT 17 lm - 3000K/CRI 80 - 24V / 2,3W - 202 lm ≠ FIXT 18 lm - 4000K/CRI 80 - 24V

2700K

- Non Dimmable
- F004A24A056
- PWM Dimmable
- F004A24H056

3000K

- Non Dimmable
- F004A34A056
- PWM Dimmable
- F004A34H056

4000K

- Non Dimmable
- F004A44A056
- PWM Dimmable
- F004A44H056

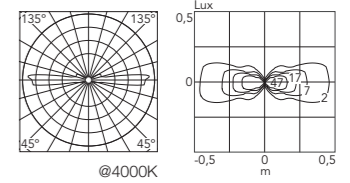

Landlord Ground 49 4 Beams

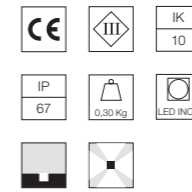
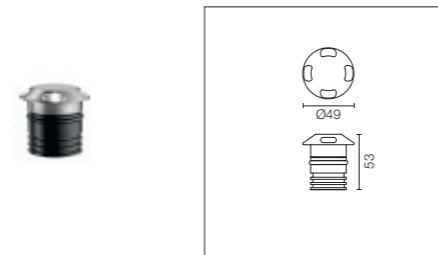

Alimentazione elettrica remota 24V da ordinare separatamente. Necessaria cassaforma per installazione, da ordinare separatamente.

24V remote power supply to be ordered separately. Necessary box for installation, to be ordered separately.

Power Led: 2,3W - 188 lm ≠ FIXT 32 lm - 2700K/CRI 80 - 24V / 2,3W - 195 lm ≠ FIXT 34 lm - 3000K/CRI 80 - 24V / 2,3W - 202 lm ≠ FIXT 36 lm - 4000K/CRI 80 - 24V

2700K

- Non Dimmable
- F004A25A056
- PWM Dimmable
- F004A25H056

3000K

- Non Dimmable
- F004A35A056
- PWM Dimmable
- F004A35H056

4000K

- Non Dimmable
- F004A45A056
- PWM Dimmable
- F004A45H056

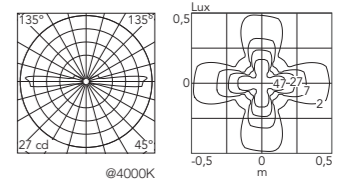

* Numero massimo di apparecchi per alimentatore / Maximum number of luminaires per power supply.

Numero massimo di apparecchi per alimentatore (Vin220÷240). Dati indicativi da verificare con le specifiche condizioni di installazione.

Maximum number of luminaires per power supply. (220÷240 V). These data must be checked taking into account the specific installation conditions.

Non Dimmable

Acc. RF25754	2
Acc. RF25748	2
Acc. RF25747	3
Acc. RF25757	3
Acc. F990B23AZ00	9
Acc. RF25755	14
Acc. RF25749	29

Dimmable

Acc. F990B02A000	13
Acc. F990B03A000	13
Acc. F990B04A000	28
Acc. F990B05A000	28

Landlord Ground Ø49: Accessori / Accessories

Cassaforma.

Box for installation.

F004Z0J0000

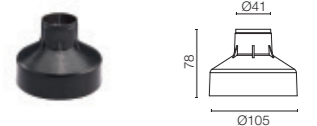

Landlord Ground 64

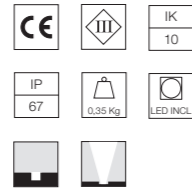
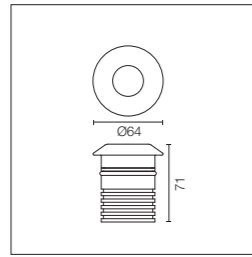

Alimentazione elettrica remota 24V da ordinare separatamente. Necessaria cassaforma per installazione, da ordinare separatamente.

24V remote power supply to be ordered separately. Necessary box for installation, to be ordered separately.

Power Led: 3,4W - 251 lm ≠ *FIXT 183 lm - 2700K/CRI 80 - 24V / 3,4W - 260 lm ≠ *FIXT 189 lm - 3000K/CRI 80 - 24V / 3,4W - 270 lm ≠ *FIXT 196 lm - 4000K/CRI 80 - 24V
*FIXT lm = Spot Optic

Optic Spot 15°

2700K

- Non Dimmable
- F004B21A056
- PWM Dimmable
- F004B21H056
- Non Dimmable with honeycomb
- F004B26A05601

3000K

- Non Dimmable
- F004B31A056
- PWM Dimmable
- F004B31H056
- Non Dimmable with honeycomb
- F004B36A05601

4000K

- Non Dimmable
- F004B41A056
- PWM Dimmable
- F004B41H056
- Non Dimmable with honeycomb
- F004B46A05601

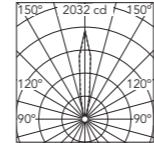

Beam Angle: 15°	h(m)	Et(x)	D(m)
1	2032	0.27	
2	508	0.53	
3	226	0.80	
4	127	1.06	
5	81	1.33	

Optic Medium 25°

2700K

- Non Dimmable
- F004B22A056
- PWM Dimmable
- F004B22H056
- Non Dimmable with honeycomb
- F004B27A05602

3000K

- Non Dimmable
- F004B32A056
- PWM Dimmable
- F004B32H056
- Non Dimmable with honeycomb
- F004B37A05602

4000K

- Non Dimmable
- F004B42A056
- PWM Dimmable
- F004B42H056
- Non Dimmable with honeycomb
- F004B47A05602

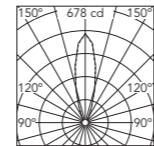

Beam Angle: 25°	h(m)	Et(x)	D(m)
1	678	0.46	
2	169	0.92	
3	75	1.38	
4	42	1.84	
5	27	2.30	

Landlord Ground 64 1 Beam

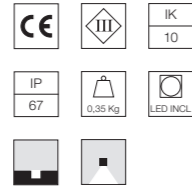
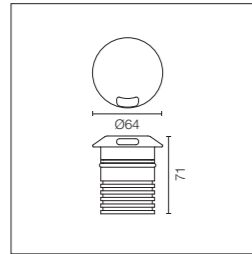

Alimentazione elettrica remota 24V da ordinare separatamente. Necessaria cassaforma per installazione, da ordinare separatamente.

24V remote power supply to be ordered separately. Necessary box for installation, to be ordered separately.

Power Led: 3,4W - 251 lm ≠ FIXT 11 lm - 2700K/CRI 80 - 24V / 3,4W - 260 lm ≠ FIXT 12 lm - 3000K/CRI 80 - 24V / 3,4W - 270 lm ≠ FIXT 12 lm - 4000K/CRI 80 - 24V

2700K

- Non Dimmable
- F004B23A056
- PWM Dimmable
- F004B23H056

3000K

- Non Dimmable
- F004B33A056
- PWM Dimmable
- F004B33H056

4000K

- Non Dimmable
- F004B43A056
- PWM Dimmable
- F004B43H056

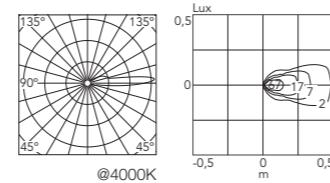

Landlord Ground 64 2 Beams

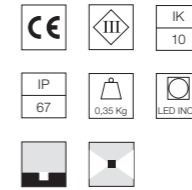
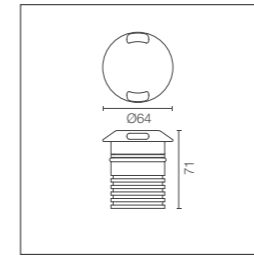

Alimentazione elettrica remota 24V da ordinare separatamente. Necessaria cassaforma per installazione, da ordinare separatamente.

24V remote power supply to be ordered separately. Necessary box for installation, to be ordered separately.

Power Led: 3,4W - 251 lm ≠ FIXT 22 lm - 2700K/CRI 80 - 24V / 3,4W - 260 lm ≠ FIXT 23 lm - 3000K/CRI 80 - 24V / 3,4W - 270 lm ≠ FIXT 24 lm - 4000K/CRI 80 - 24V

2700K

- Non Dimmable
- F004B24A056
- PWM Dimmable
- F004B24H056

3000K

- Non Dimmable
- F004B34A056
- PWM Dimmable
- F004B34H056

4000K

- Non Dimmable
- F004B44A056
- PWM Dimmable
- F004B44H056

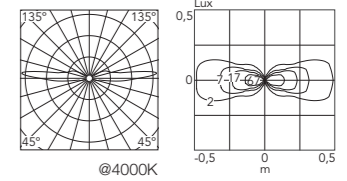

Landlord Ground 64 4 Beams

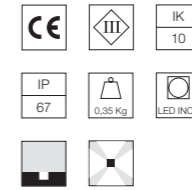
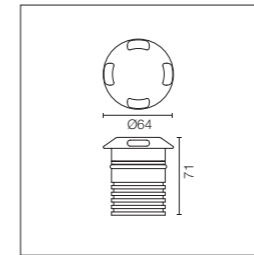

Alimentazione elettrica remota 24V da ordinare separatamente. Necessaria cassaforma per installazione, da ordinare separatamente.

24V remote power supply to be ordered separately. Necessary box for installation, to be ordered separately.

Power Led: 3,4W - 251 lm ≠ FIXT 44 lm - 2700K/CRI 80 - 24V / 3,4W - 260 lm ≠ FIXT 46 lm - 3000K/CRI 80 - 24V / 3,4W - 270 lm ≠ FIXT 48 lm - 4000K/CRI 80 - 24V

2700K

- Non Dimmable
- F004B25A056
- PWM Dimmable
- F004B25H056

3000K

- Non Dimmable
- F004B35A056
- PWM Dimmable
- F004B35H056

4000K

- Non Dimmable
- F004B45A056
- PWM Dimmable
- F004B45H056

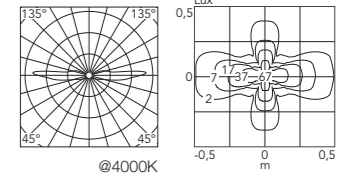

* Numero massimo di apparecchi per alimentatore / Maximum number of luminaires per power supply.

Numero massimo di apparecchi per alimentatore (Vin220÷240). Dati indicativi da verificare con le specifiche condizioni di installazione.

Maximum number of luminaires per power supply. (220÷240 V). These data must be checked taking into account the specific installation conditions.

Non Dimmable

Acc. RF25754	1
Acc. RF25748	1
Acc. RF25747	3
Acc. RF25757	3
Acc. F990B23AZ00	7
Acc. RF25755	9
Acc. RF25749	17

Dimmable

Acc. F990B02A000	7
Acc. F990B03A000	7
Acc. F990B04A000	17
Acc. F990B05A000	17

Landlord Ground Ø64: Accessori / Accessories

Cassaforma.

Box for installation.

F004Z0K0000

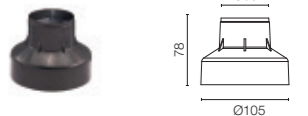

Landlord: Accessori / Accessories

Sistema di giunzione IP68 a 2 vie 2 poli. (Ø4÷6,9mm cavo).
2 way terminal block 2 poles IP68. (Ø4÷6,9mm cable).

F990C050000



Non può essere alloggiato nella scatola per incasso.
It can't be placed in the recessed box for installation.

It can't be placed in the recessed box for installation.

Landlord (all versions): Power Supply Dimmable

Alimentatore 120/270Vac / 24Vdc. 1-10V PWM control. IP67.

Power supply 120/270Vac / 24Vdc. 1-10V PWM control. IP67.

35W
*F990B02A000
70W
*F990B04A000



Alimentatore 120/270Vac / 24Vdc. DALI PWM control. IP67.

Power supply 120/270Vac / 24Vdc. DALI PWM control. IP67.

35W
*F990B03A000
70W
*F990B05A000



Interfaccia di controllo 1-10V PWM 24Vdc 120W. IP67. Fonte di alimentazione non inclusa.

1-10V PWM control interface 24Vdc 120W. IP67. Power supply not included.

F990B00A000



Interfaccia di controllo DALI PWM 24Vdc 120W. IP67. Fonte di alimentazione non inclusa.

DALI PWM control interface 24Vdc 120W. IP67. Power supply not included.

F990B01A000



Landlord: Power Supply Non Dimmable

Alimentatore 24V 8W / 110-240V IP20 Classe II selv.

Power supply 24V 8W / 110-240V IP20 Class II selv.

*RF25754



Alimentatore 24V 8W / 110-240V IP65 Classe II selv.

Power supply 24V 8W / 110-240V IP65 Class II selv.

*RF25748

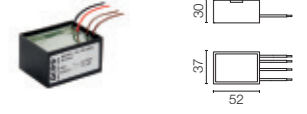

Alimentatore 24V 10W / 110-240V IP20 Classe II selv.

Power supply 24V 10W / 110-240V IP20 Class II selv.

*RF25747



Alimentatore 24V 10W / 110-240V IP67 Classe II selv.

Power supply 24V 10W / 110-240V IP67 Class II selv.

*RF25757

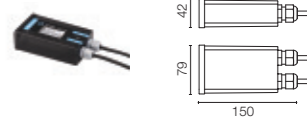

Alimentatore 24Vdc 35W / 120-270V IP67 Classe II selv.

Power supply 24Vdc 35W / 120-270V IP67 Class II selv.

*F990B23AZ00

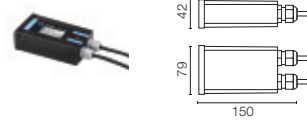

Alimentatore 24Vdc 50W / 120-240V IP67 Classe II selv.

Power supply 24Vdc 50W / 120-240V IP67 Class II selv.

*RF25755

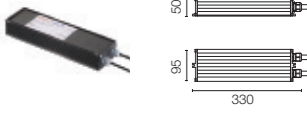

Alimentatore 24Vdc 70W / 220-240V IP67 Classe II selv.

Power supply 24Vdc 70W / 220-240V IP67 Class II selv.

*RF25749

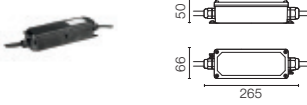

Bellhop

Designed by Edward Barber & Jay Osgerby



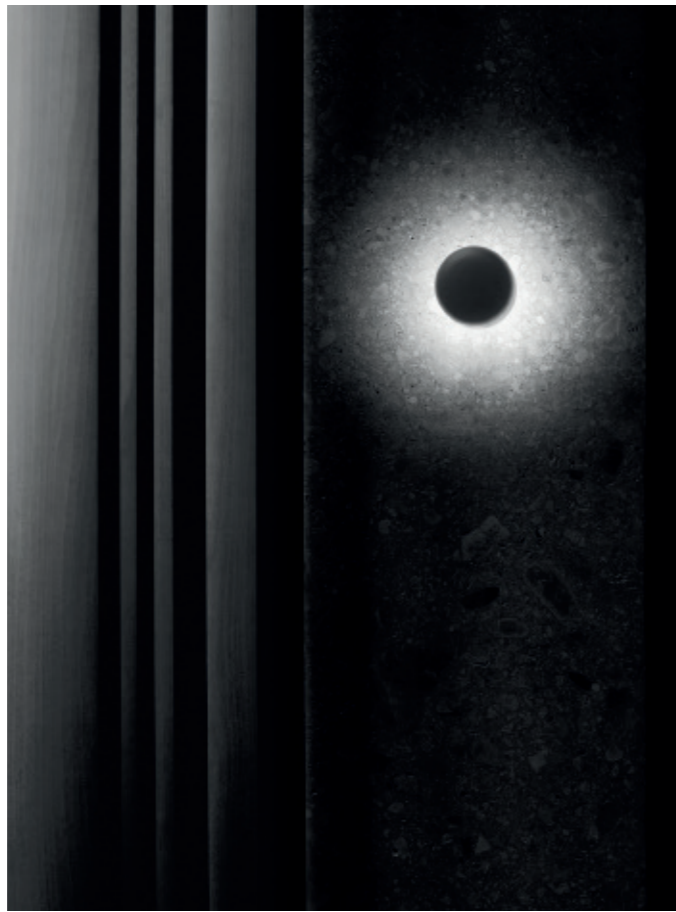

Bellhop Wall



Bellhop Pole



Bellhop Bollard

Famiglia / Family

Bellhop Wall



Bellhop Bollard



Bellhop Pole



Power Led

8W
551 lm - 2700K/CRI 80
580 lm - 3000K/CRI 80
607 lm - 4000K/CRI 80

Power Led

8W
551 lm - 2700K/CRI 80
580 lm - 3000K/CRI 80
607 lm - 4000K/CRI 80

Power Led

30W
2490 lm - 2700K/CRI 80
2590 lm - 3000K/CRI 80
2760 lm - 4000K/CRI 80

Colori / Colours

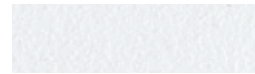

01 White*



06 Grey



12 Forest Green*



18 Deep Brown



30 Black*



33 Anthracite



56 Matt Stainless
Steel*

* Solo per versioni bollard e wall. / Only for bollard and wall versions.

Descrizione / Description

Bellhop Wall

Apparecchi di illuminazione da parete della collezione per esterni Bellhop con illuminazione diffusa; è realizzata in alluminio estruso e pressofuso oppure in acciaio inossidabile.

Bellhop Bollard

Versione Bollard della collezione per esterni di Bellhop per un'illuminazione diffusa. Realizzata in alluminio estruso e pressofuso o acciaio inossidabile, Bellhop è disponibile in due altezze diverse per il modello bollard e con un flusso ed emissione luminose diverse in modo da soddisfare qualsiasi esigenza di illuminazione esterna o prospettiva d'illuminazione necessaria.

Bellhop Pole

Versione su palo della collezione per esterni di Bellhop a luce diffusa.
Testa in alluminio montata su un palo estruso lungo 3 m o 4 m, disponibile per installazione su superficie rigida o a terra.

Bellhop Wall

Wall light version of the Bellhop Outdoor Collection for diffuse light, made of extruded and die-cast aluminium or stainless steel.

Bellhop Bollard

Bollard version of the Bellhop Outdoor Collection for diffuse light. Made of extruded and die-cast aluminium or stainless steel, Bellhop is available in two heights for the bollard model and with different lumens and luminaire outputs as to comply with any outdoor setting and lighting scenario need.

Bellhop Pole

Pole version of the Bellhop Outdoor Collection for diffuse light.
Aluminum head mounted on a 3m or 4m long extruded pole, available for installation on rigid surface or in ground.

Bellhop Wall

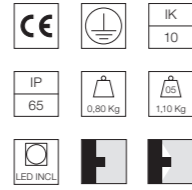
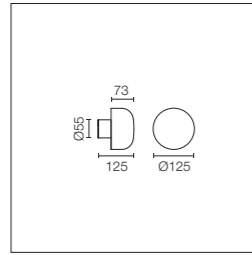

Alimentazione elettrica 100-240V integrata. Attacco a parete.
Ogni apparecchio d'illuminazione è dotato di 200 mm di cavo per connessione all'interno del corpo dell'apparecchio.
La connessione è consigliata con un sistema di giunzione IP68 H₂O Stop anti-condensa a 2 vie 4 poli, da ordinare separatamente.

100-240V power supply integrated. Direct wall installation.
Each luminaire is equipped with 200 mm length cable for connection inside the luminaire body.
Recommended connection with a 2 way terminal block 4 poles IP68 H₂O Stop, to be ordered separately.

Power Led: 8W - 783 lm ≠ FIXT 551 lm - 2700K/CRI 80 - 100-240V / 8W - 816 lm ≠ FIXT 580 lm - 3000K/CRI 80 - 100-240V / 8W - 873 lm ≠ FIXT 607 lm - 4000K/CRI 80 - 100-240V

2700K

- F003C21A001
- F003C21A006
- F003C21A012
- F003C21A018
- F003C21A030
- F003C21A033
- F003C21A056
- 1-10V
- F003C21B001
- F003C21B006
- F003C21B012
- F003C21B018
- F003C21B030
- F003C21B033
- F003C21B056
- Dali
- F003C21D001
- F003C21D006
- F003C21D012
- F003C21D018
- F003C21D030
- F003C21D033
- F003C21D056

3000K

- F003C31A001
- F003C31A006
- F003C31A012
- F003C31A018
- F003C31A030
- F003C31A033
- F003C31A056
- 1-10V
- F003C31B001
- F003C31B006
- F003C31B012
- F003C31B018
- F003C31B030
- F003C31B033
- F003C31B056
- Dali
- F003C31D001
- F003C31D006
- F003C31D012
- F003C31D018
- F003C31D030
- F003C31D033
- F003C31D056

4000K

- F003C41A001
- F003C41A006
- F003C41A012
- F003C41A018
- F003C41A030
- F003C41A033
- F003C41A056
- 1-10V
- F003C41B001
- F003C41B006
- F003C41B012
- F003C41B018
- F003C41B030
- F003C41B033
- F003C41B056
- Dali
- F003C41D001
- F003C41D006
- F003C41D012
- F003C41D018
- F003C41D030
- F003C41D033
- F003C41D056

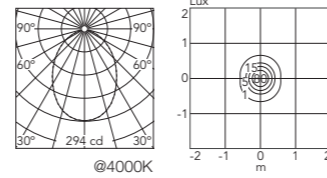

Bellhop Bollard 380

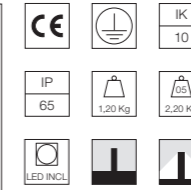
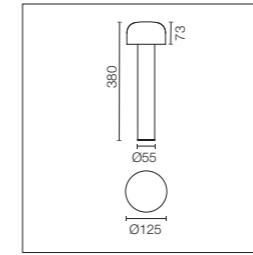

Alimentazione elettrica 100-240V inclusa. Pronta per l'installazione su superficie solida.
Ogni apparecchio d'illuminazione è dotato di 200 mm di cavo per connessione all'interno del corpo dell'apparecchio.
La connessione è consigliata con un sistema di giunzione IP68 H₂O Stop anti-condensa a 2 vie 4 poli, da ordinare separatamente.

100-240V power supply included. Ready for installation on solid surface.
Each luminaire is equipped with 200 mm cable for connection inside the luminaire body.
Recommended connection with a 2 way terminal block 4 poles IP68 H₂O Stop, to be ordered separately.

Power Led: 8W - 783 lm ≠ FIXT 551 lm - 2700K/CRI 80 - 100-240V / 8W - 816 lm ≠ FIXT 580 lm - 3000K/CRI 80 - 100-240V / 8W - 873 lm ≠ FIXT 607 lm - 4000K/CRI 80 - 100-240V

2700K

- F003A21A001
- F003A21A006
- F003A21A012
- F003A21A018
- F003A21A030
- F003A21A033
- F003A21A056
- 1-10V
- F003A21B001
- F003A21B006
- F003A21B012
- F003A21B018
- F003A21B030
- F003A21B033
- F003A21B056
- Dali
- F003A21D001
- F003A21D006
- F003A21D012
- F003A21D018
- F003A21D030
- F003A21D033
- F003A21D056

3000K

- F003A31A001
- F003A31A006
- F003A31A012
- F003A31A018
- F003A31A030
- F003A31A033
- F003A31A056
- 1-10V
- F003A31B001
- F003A31B006
- F003A31B012
- F003A31B018
- F003A31B030
- F003A31B033
- F003A31B056
- Dali
- F003A31D001
- F003A31D006
- F003A31D012
- F003A31D018
- F003A31D030
- F003A31D033
- F003A31D056

4000K

- F003A41A001
- F003A41A006
- F003A41A012
- F003A41A018
- F003A41A030
- F003A41A033
- F003A41A056
- 1-10V
- F003A41B001
- F003A41B006
- F003A41B012
- F003A41B018
- F003A41B030
- F003A41B033
- F003A41B056
- Dali
- F003A41D001
- F003A41D006
- F003A41D012
- F003A41D018
- F003A41D030
- F003A41D033
- F003A41D056

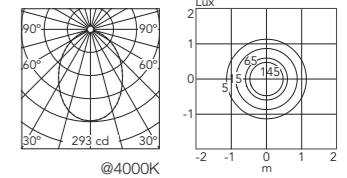

Bellhop Bollard 850

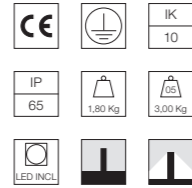
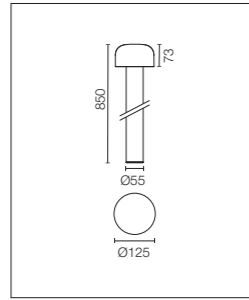

Alimentazione elettrica 100-240V inclusa. Pronta per l'installazione su superficie solida.
Ogni apparecchio d'illuminazione è dotato di 200 mm di cavo per connessione all'interno del corpo dell'apparecchio.
La connessione è consigliata con un sistema di giunzione IP68 H₂O Stop anti-condensa a 2 vie 4 poli, da ordinare separatamente.

100-240V power supply included. Ready for installation on solid surface.
Each luminaire is equipped with 200 mm cable for connection inside the luminaire body.
Recommended connection with a 2 way terminal block 4 poles IP68 H₂O Stop, to be ordered separately.

Power Led: 8W - 783 lm ≠ FIXT 551 lm - 2700K/CRI 80 - 100-240V / 8W - 816 lm ≠ FIXT 580 lm - 3000K/CRI 80 - 100-240V / 8W - 873 lm ≠ FIXT 607 lm - 4000K/CRI 80 - 100-240V

2700K

Non Dimmable

- F003B21A001
- F003B21A006
- F003B21A012
- F003B21A018
- F003B21A030
- F003B21A033
- F003B21A056

1-10V

- F003B21B001
- F003B21B006
- F003B21B012
- F003B21B018
- F003B21B030
- F003B21B033
- F003B21B056

Dali

- F003B21D001
- F003B21D006
- F003B21D012
- F003B21D018
- F003B21D030
- F003B21D033
- F003B21D056

3000K

Non Dimmable

- F003B31A001
- F003B31A006
- F003B31A012
- F003B31A018
- F003B31A030
- F003B31A033
- F003B31A056

1-10V

- F003B31B001
- F003B31B006
- F003B31B012
- F003B31B018
- F003B31B030
- F003B31B033
- F003B31B056

Dali

- F003B31D001
- F003B31D006
- F003B31D012
- F003B31D018
- F003B31D030
- F003B31D033
- F003B31D056

4000K

Non Dimmable

- F003B41A001
- F003B41A006
- F003B41A012
- F003B41A018
- F003B41A030
- F003B41A033
- F003B41A056

1-10V

- F003B41B001
- F003B41B006
- F003B41B012
- F003B41B018
- F003B41B030
- F003B41B033
- F003B41B056

Dali

- F003B41D001
- F003B41D006
- F003B41D012
- F003B41D018
- F003B41D030
- F003B41D033
- F003B41D056

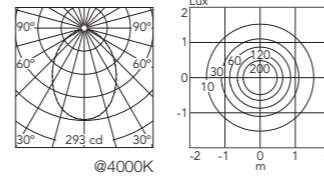

Accessori / Accessories

Piastra tirafondi.

Base plate with bolt.

Bellhop Bollard Ø125

F003Z010000



Bellhop Pole with base

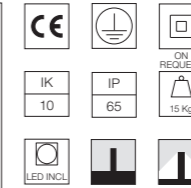
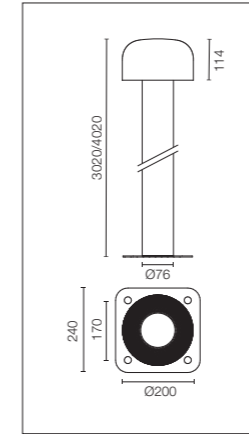

Alimentazione elettrica 220/240V inclusa. Pronta per l'installazione su superficie solida.
Piastra base disponibile come accessorio.
Ogni apparecchio d'illuminazione è dotato di 200 mm di cavo per connessione all'interno del corpo dell'apparecchio.
La connessione è consigliata con un sistema di giunzione IP68 H₂O Stop anti-condensa a 2 vie 4 poli, da ordinare separatamente.
Versione dimmerabile e 110V disponibili su richiesta.

220-240V power supply included. Ready for installation on solid surface.
Base plate available as accessory.
Each luminaire is equipped with 200 mm cable for connection inside the luminaire body.
Recommended connection with a 2 way terminal block 4 poles IP68 H₂O Stop, to be ordered separately.
110V and dimmable versions available on request.

Power Led: 30W - 3090 lm ≠ FIXT 2490 lm - 2700K/CRI 80 - 220-240V / 30W - 3220 lm ≠ FIXT 2590 lm - 3000K/CRI 80 - 220-240V / 30W - 3430 lm ≠ FIXT 2760 lm - 4000K/CRI 80 - 220-240V

2700K

H 3020 mm

Non Dimmable

- F003H21A006
- F003H21A018
- F003H21A033

1-10V

- F003H21B006
- F003H21B018
- F003H21B033

Dali

- F003H21D006
- F003H21D018
- F003H21D033

3000K

H 3020 mm

Non Dimmable

- F003H31A006
- F003H31A018
- F003H31A033

1-10V

- F003H31B006
- F003H31B018
- F003H31B033

Dali

- F003H31D006
- F003H31D018
- F003H31D033

4000K

H 3020 mm

Non Dimmable

- F003H41A006
- F003H41A018
- F003H41A033

1-10V

- F003H41B006
- F003H41B018
- F003H41B033

Dali

- F003H41D006
- F003H41D018
- F003H41D033

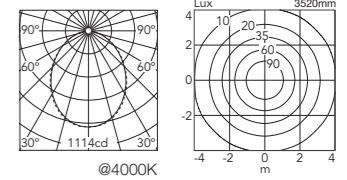

2700K

H 4020 mm

Non Dimmable

- F003L21A006
- F003L21A018
- F003L21A033

1-10V

- F003L21B006
- F003L21B018
- F003L21B033

Dali

- F003L21D006
- F003L21D018
- F003L21D033

3000K

H 4020 mm

Non Dimmable

- F003L31A006
- F003L31A018
- F003L31A033

1-10V

- F003L31B006
- F003L31B018
- F003L31B033

Dali

- F003L31D006
- F003L31D018
- F003L31D033

4000K

H 4020 mm

Non Dimmable

- F003L41A006
- F003L41A018
- F003L41A033

1-10V

- F003L41B006
- F003L41B018
- F003L41B033

Dali

- F003L41D006
- F003L41D018
- F003L41D033

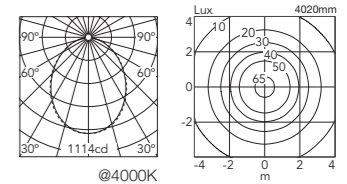

Accessori / Accessories

Piastra tirafondi per versione Bellhop palo con base.

Base plate with bolt for Bellhop Pole with base version.

Bellhop Pole Ø200

F990G300000

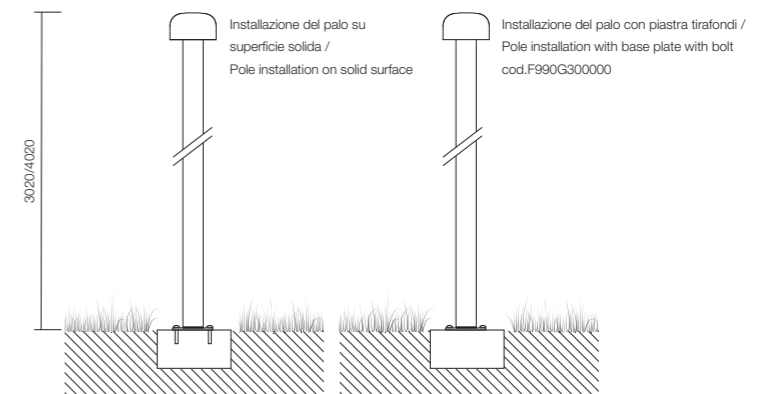
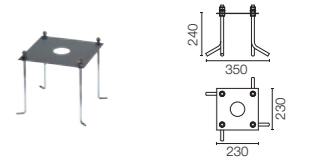

Bellhop Pole Inground

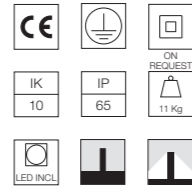
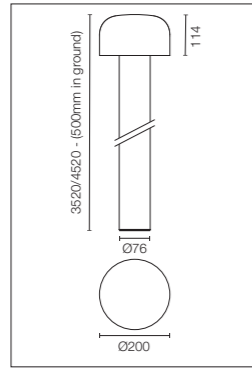
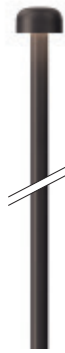

Alimentazione elettrica 220-240V inclusa.
Pronto per l'installazione a terra.
Ogni apparecchio d'illuminazione è dotato di 200 mm di cavo per connessione all'interno del corpo dell'apparecchio.
La connessione è consigliata con un sistema di giunzione IP68 H₂O Stop anti-condensa a 2 vie 4 poli, da ordinare separatamente.
Versione dimmerabile e 110V disponibili su richiesta.

220-240V power supply included.
Ready for inground installation.
Each luminaire is equipped with 200 mm cable for connection inside the luminaire body.
Recommended connection with a 2 way terminal block 4 poles IP68 H₂O Stop, to be ordered separately.
110V and dimmable versions available on request.

Power Led: 30W - 3090 lm ≠ FIXT 2490 lm - 2700K/CRI 80 - 220-240V / 30W - 3220 lm ≠ FIXT 2590 lm - 3000K/CRI 80 - 220-240V / 30W - 3430 lm ≠ FIXT 2760 lm - 4000K/CRI 80 - 220-240V

2700K

H 3520 mm
Non Dimmable

- F003G21A006
- F003G21A018
- F003G21A033
- 1-10V
- F003G21B006
- F003G21B033
- F003G21B018
- Dali
- F003G21D006
- F003G21D018
- F003G21D033

3000K

H 3520 mm
Non Dimmable

- F003G31A006
- F003G31A018
- F003G31A033
- 1-10V
- F003G31B006
- F003G31B018
- F003G31B033
- Dali
- F003G31D006
- F003G31D018
- F003G31D033

4000K

H 3520 mm
Non Dimmable

- F003G41A006
- F003G41A018
- F003G41A033
- 1-10V
- F003G41B006
- F003G41B018
- F003G41B033
- Dali
- F003G41D006
- F003G41D018
- F003G41D033

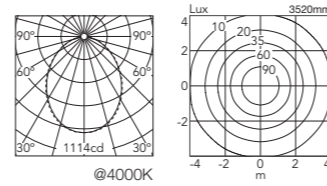

2700K

H 4520 mm
Non Dimmable

- F003K21A006
- F003K21A018
- F003K21A033
- 1-10V
- F003K21B006
- F003K21B018
- F003K21B033
- Dali
- F003K21D006
- F003K21D018
- F003K21D033

3000K

H 4520 mm
Non Dimmable

- F003K31A006
- F003K31A018
- F003K31A033
- 1-10V
- F003K31B006
- F003K31B018
- F003K31B033
- Dali
- F003K31D006
- F003K31D018
- F003K31D033

4000K

H 4520 mm
Non Dimmable

- F003K41A006
- F003K41A018
- F003K41A033
- 1-10V
- F003K41B006
- F003K41B018
- F003K41B033
- Dali
- F003K41D006
- F003K41D018
- F003K41D033

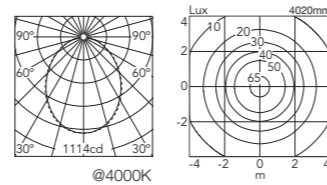

Accessori / Accessories

Sistema di giunzione IP68 H₂O Stop anti-condensa a 2 vie 4 poli. (Ø5,5÷12mm cavo).

2 way terminal block 4 poles IP68 H₂O Stop. (ø5,5÷12mm cable).

Bellhop Wall / Bollard / Pole
F990C00A000



Dispositivo di protezione per il sovraccarico. 240 Vac. Corrente massima di scarica 10KA (8/29us). Massima corrente operativa 5A. Adatto per la connessione in serie. IP66.

Surge protection device. 275Vac. Maximum discharge current 10KA (8/20us). Maximum operating current 5A. Suitable for series connection. IP66.

Bellhop Wall / Bollard / Pole
F990E00A000

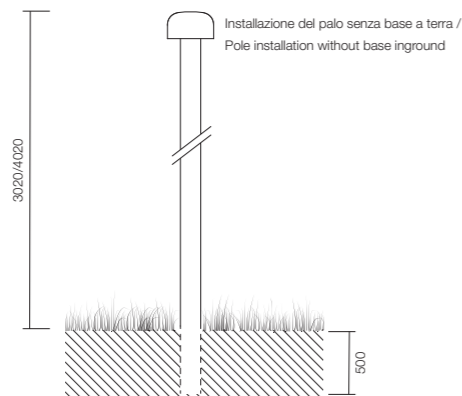
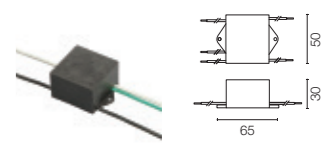

Casting



Designed by Vincent Van Duysen



Casting Concrete



Casting T

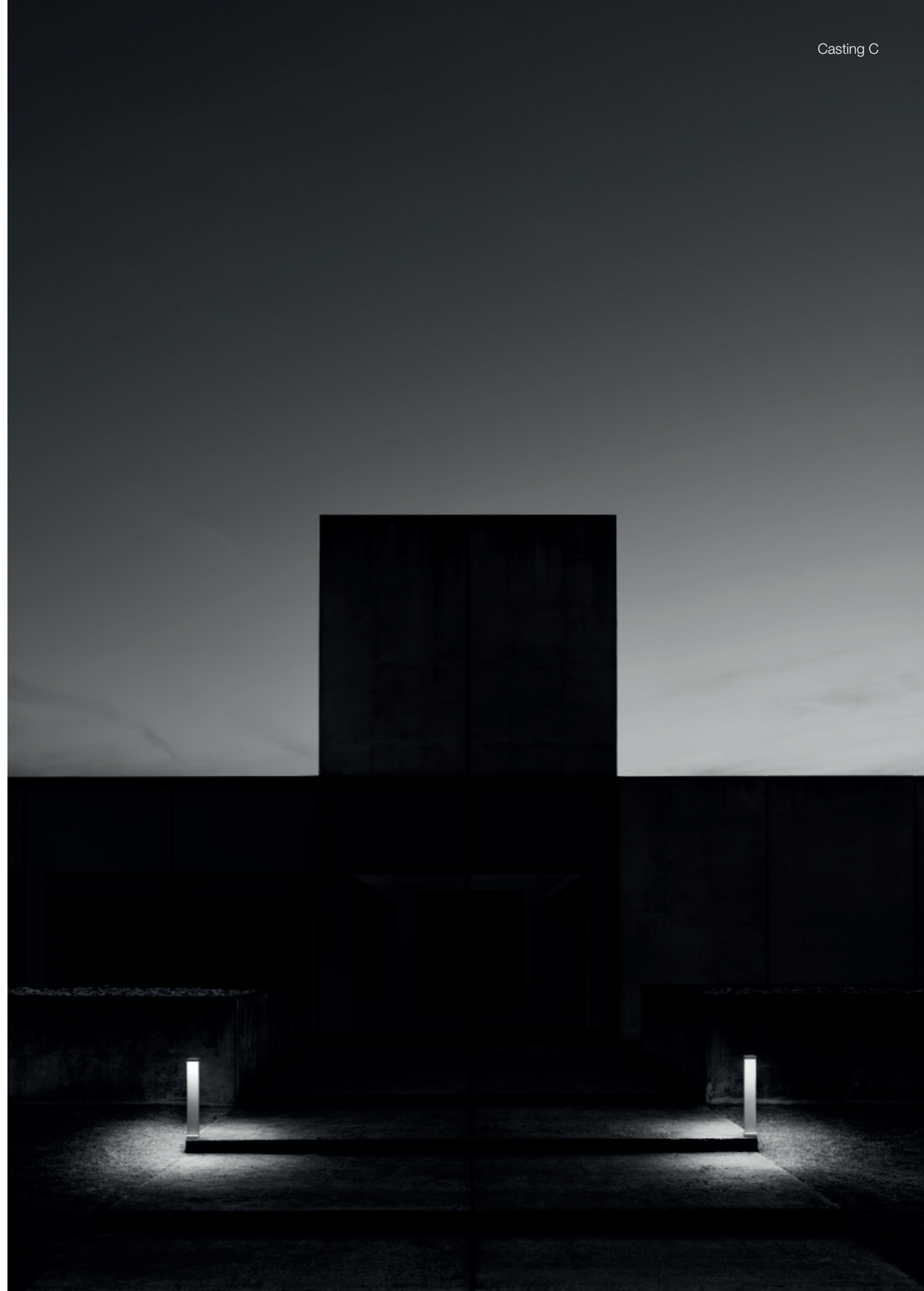

Famiglia / Family

Casting Concrete



Power Led

9W
427 lm - 2700K/CRI 80
513 lm - 3000K/CRI 80
526 lm - 4000K/CRI 80

Casting C



W: 100
H: 200 / 500 / 700 mm

Power Led

7W
272 lm - 2700K/CRI 80
295 lm - 3000K/CRI 80
317 lm - 4000K/CRI 80



W: 150
H: 250 / 500 / 850 mm

Power Led

12W
565 lm - 2700K/CRI 80
813 lm - 3000K/CRI 80
660 lm - 4000K/CRI 80

Casting T



W: 100
H: 200 / 500 / 700 mm

Power Led

12W
2x272 lm - 2700K/CRI 80
2x295 lm - 3000K/CRI 80
2x317 lm - 4000K/CRI 80



W: 150
H: 250 / 500 / 850 mm

Power Led

21W
2x565 lm - 2700K/CRI 80
2x813 lm - 3000K/CRI 80
2x660 lm - 4000K/CRI 80

Colori / Colours

Casting Concrete

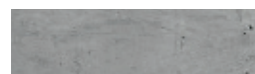

89 Concrete

Casting C / T



01 White



06 Grey



12 Forest Green



18 Deep Brown



30 Black



33 Anthracite

Descrizione / Description

Collezione di paletti luminosi per esterno, con fonte di luce a LED.

Casting Concrete

Il corpo della versione Concrete è realizzato in stampo, con getto di calcestruzzo composta da cemento, aggreganti inerti fini e fibre di rinforzo. Ogni manufatto è realizzato individualmente con processo artigianale: minime differenze estetiche e di colore tra un apparecchio e l'altro sono il segno dell'unicità di ciascuna lampada. Ogni apparecchio monta un diffusore in policarbonato satinato incollato al dissipatore del prodotto per garantire la tenuta all'acqua (stabilizzato ai raggi UV per minimizzarne l'ingiallimento).

L'apparecchio è fornito con uno spezzone di cavo uscente in neoprene, con un kit di connessione elettrica per cavo multipolare singolo, e con tasselli per installazione su superfici piene e solide.

La piastra di fissaggio per installazione su calcestruzzo, pavimentazione da gettare, o su plinto è disponibile come accessorio.

Casting C/T

Il corpo delle versioni C e T è realizzato in alluminio estruso, base e diffusore in alluminio pressofuso EN AB-47100 a basso contenuto di rame.

Rivestimento ad alta resistenza: dopo un trattamento di sabbiatura di tutti i componenti per rendere la superficie porosa e garantire una maggiore adesione della vernice, è applicato il rivestimento esterno con un doppio strato con polveri secondo lo standard QUALICOAT. Il primo strato di polvere epossidica dà resistenza chimica e meccanica, il secondo strato di finitura di polvere poliestere assicura resistenza ai raggi UV ed agli agenti atmosferici. Le superfici verniciate sono trattate con lavaggi alcalini e acidi, risciacquate con acqua demineralizzata, e sottoposte a un trattamento di conversione chimica per proteggere contro l'ossidazione. Diffusore in vetro incollato al dissipatore del prodotto per garantire la tenuta all'acqua, e microtesturizzato per garantire una distribuzione omogenea e uniforme della luce. L'apparecchio è fornito con uno spezzone di cavo uscente in neoprene.

Collection of outdoor bollard lights with LED light source.

Casting Concrete

The body of the Round version is made from a mould, with poured concrete consisting of cement, fine inert materials for aggregating purposes, and reinforcing fibers. Each article is manufactured individually with a handcrafted process: minor aesthetic and color differences between one luminaire and another are the sign of the uniqueness of each lamp. Each luminaire has a frosted polycarbonate diffuser glued to the heat sink of the product to ensure a watertight seal (UV stabilized to minimise yellowing).

The luminaire is provided with a segment of outgoing cable in neoprene, with a kit of electrical connection for single multicore cable, and with dowels for installation on full and solid surfaces. The fixing plate for installation on cement paving, poured concrete, or on plinth is available as an accessory.

Casting C/T

The body of the versions C and T is made of extruded aluminum, base and diffuser in die-cast aluminum EN AB-47100 with a low copper content.

High-resistance coating: after a sandblasting treatment of all components to make the surface porous and ensure a greater adhesion of the paint, the external coating is applied with a double layer with epoxy powders according to the QUALICOAT standard. The first layer of epoxy powder gives chemical and mechanical resistance, the second finishing layer of polyester powder ensures resistance to UV rays and atmospheric agents.

The painted surfaces are treated with alkaline and acidic washes, then rinsed with demineralized water, subjected to a chemical conversion treatment to protect against oxidation. A glass diffuser is glued to the heat sink of the product to ensure a watertight seal, micro-texturized to ensure homogeneous and uniform distribution of the light.

The luminaire is provided with a segment of outgoing cable in neoprene.

Casting Concrete

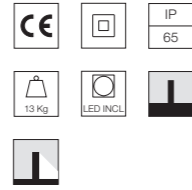
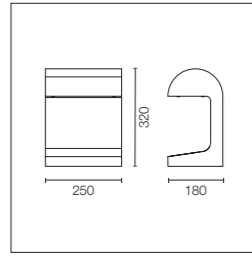

Alimentazione elettrica
220/240V integrata.

220/240V power supply
integrated.

Power Led: 9W - 650 lm ≠ FIXT 427 lm - 2700K/CRI 80 - 220-240V / 9W - 780 lm ≠ FIXT 513 lm - 3000K/CRI 80 - 220-240V / 9W - 800 lm ≠ FIXT 526 lm - 4000K/CRI 80 - 220-240V

2700K

● F1330089

3000K

● F1331089

4000K

● F1332089

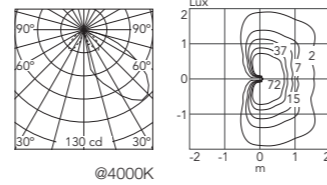

Casting Concrete: Accessori / Accessories

Piastra tirafondi.	Base plate with bolt.	F1209000	
Sistema di giunzione IP68 H2O Stop anti-condensa a 3/4 vie 4 poli. (Ø5,5÷12mm cavo).	3/4 way terminal block 4 poles IP68 H2O Stop. (ø5,5÷12mm cable).	F990C010000	
Dispositivo di protezione per il sovraccarico. 275 Vac. Corrente massima di scarica 10KA (8/29us). Massima corrente operativa 5A. Adatto per la connessione in serie. IP66.	Surge protection device. 275Vac. Maximum discharge current 10KA (8/20us). Maximum operating current 5A. Suitable for series connection. IP66.	F990E00A000	

Casting C 100

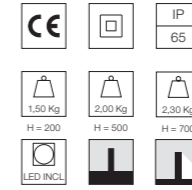
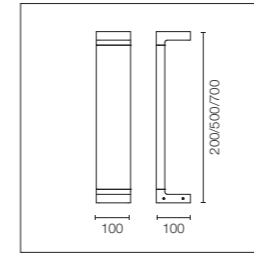

Alimentazione elettrica 110/240V
integrata.

110/240V power supply
integrated.

Power Led: 7W - 540 lm ≠ FIXT 272 lm - 2700K/CRI 80 - 110-240V / 7W - 585 lm ≠ FIXT 295 lm - 3000K/CRI 80 - 110-240V / 7W - 630 lm ≠ FIXT 317 lm - 4000K/CRI 80 - 110-240V

2700K

H 200 mm

- F1210001
- F1210006
- F1210012
- F1210018
- F1210030
- F1210033

H 500 mm

- F1213001
- F1213006
- F1213012
- F1213018
- F1213030
- F1213033

H 700 mm

- F1216001
- F1216006
- F1216012
- F1216018
- F1216030
- F1216033

3000K

H 200 mm

- F1211001
- F1211006
- F1211012
- F1211018
- F1211030
- F1211033

H 500 mm

- F1214001
- F1214006
- F1214012
- F1214018
- F1214030
- F1214033

H 700 mm

- F1217001
- F1217006
- F1217012
- F1217018
- F1217030
- F1217033

4000K

H 200 mm

- F1212001
- F1212006
- F1212012
- F1212018
- F1212030
- F1212033

H 500 mm

- F1215001
- F1215006
- F1215012
- F1215018
- F1215030
- F1215033

H 700 mm

- F1218001
- F1218006
- F1218012
- F1218018
- F1218030
- F1218033

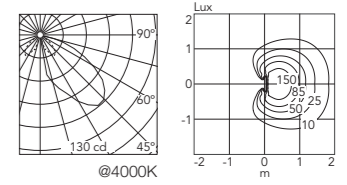
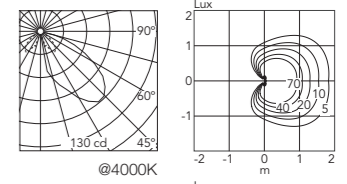
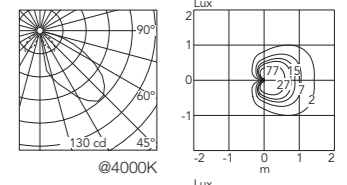

Casting C 150

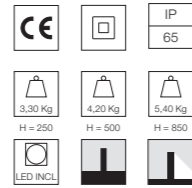
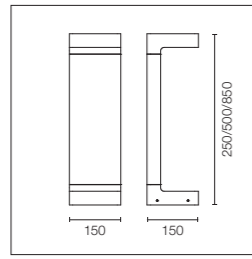

Alimentazione elettrica 110/240V integrata.

110/240V power supply integrated.

Power Led: 12W - 1080 lm ≠ FIXT 565 lm - 2700K/CRI 80 - 110-240V / 12W - 1170 lm ≠ FIXT 613 lm - 3000K/CRI 80 - 110-240V / 12W - 1260 lm ≠ FIXT 660 lm - 4000K/CRI 80 - 110-240V

2700K

H 250 mm - Non Dimmable

- F1230001
- F1230006
- F1230012
- F1230018
- F1230033
- F1230030

- F1230001-310
- F1230006-310
- F1230012-310
- F1230018-310
- F1230030-310
- F1230033-310

- F1230001-300
- F1230006-300
- F1230012-300
- F1230018-300
- F1230030-300
- F1230033-300

2700K

H 500 mm - Non Dimmable

- F1233001
- F1233006
- F1233012
- F1233018
- F1233030
- F1233033

- F1233001-310
- F1233006-310
- F1233012-310
- F1233018-310
- F1233030-310
- F1233033-310

- F1233001-300
- F1233006-300
- F1233012-300
- F1233018-300
- F1233030-300
- F1233033-300

2700K

H 850 mm - Non Dimmable

- F1236001
- F1236006
- F1236012
- F1236018
- F1236030
- F1236033

- F1236001-310
- F1236006-310
- F1236012-310
- F1236018-310
- F1236030-310
- F1236033-310

- F1236001-300
- F1236006-300
- F1236012-300
- F1236018-300
- F1236030-300
- F1236033-300

3000K

H 250 mm - Non Dimmable

- F1231001
- F1231006
- F1231012
- F1231018
- F1231030
- F1231033

- F1231001-310
- F1231006-310
- F1231012-310
- F1231018-310
- F1231030-310
- F1231033-310

- F1231001-300
- F1231006-300
- F1231012-300
- F1231018-300
- F1231030-300
- F1231033-300

3000K

H 500 mm - Non Dimmable

- F1234001
- F1234006
- F1234012
- F1234018
- F1234030
- F1234033

- F1234001-310
- F1234006-310
- F1234012-310
- F1234018-310
- F1234030-310
- F1234033-310

- F1234001-300
- F1234006-300
- F1234012-300
- F1234018-300
- F1234030-300
- F1234033-300

3000K

H 850 mm - Non Dimmable

- F1237001
- F1237006
- F1237012
- F1237018
- F1237030
- F1237033

- F1237001-310
- F1237006-310
- F1237012-310
- F1237018-310
- F1237030-310
- F1237033-310

- F1237001-300
- F1237006-300
- F1237012-300
- F1237018-300
- F1237030-300
- F1237033-300

4000K

H 250 mm - Non Dimmable

- F1232001
- F1232006
- F1232012
- F1232018
- F1232030
- F1232033

- F1232001-310
- F1232006-310
- F1232012-310
- F1232018-310
- F1232030-310
- F1232033-310

- F1232001-300
- F1232006-300
- F1232012-300
- F1232018-300
- F1232030-300
- F1232033-300

4000K

H 500 mm - Non Dimmable

- F1235001
- F1235006
- F1235012
- F1235018
- F1235030
- F1235033

- F1235001-310
- F1235006-310
- F1235012-310
- F1235018-310
- F1235030-310
- F1235033-310

- F1235001-300
- F1235006-300
- F1235012-300
- F1235018-300
- F1235030-300
- F1235033-300

4000K

H 850 mm - Non Dimmable

- F1238001
- F1238006
- F1238012
- F1238018
- F1238030
- F1238033

- F1238001-310
- F1238006-310
- F1238012-310
- F1238018-310
- F1238030-310
- F1238033-310

- F1238001-300
- F1238006-300
- F1238012-300
- F1238018-300
- F1238030-300
- F1238033-300

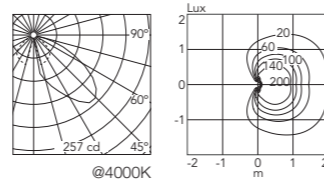
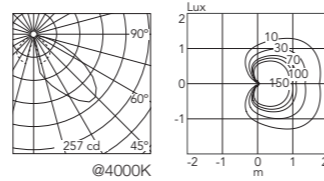
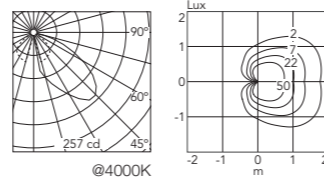

Casting T 100

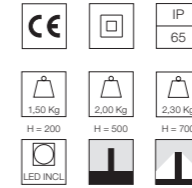
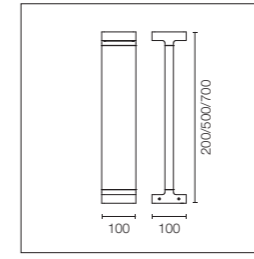

Alimentazione elettrica 110/240V integrata.

110/240V power supply integrated.

Power Led: 12W - 2x540 lm ≠ FIXT 2x272 lm - 2700K/CRI 80 - 110-240V / 12W - 2x585 lm ≠ FIXT 2x295 lm - 3000K/CRI 80 - 110-240V / 12W - 2x630 lm ≠ FIXT 2x317 lm - 4000K/CRI 80 - 110-240V

2700K

H 200 mm

- F1250001
- F1250006
- F1250012
- F1250018
- F1250030
- F1250033

- F1253001
- F1253006
- F1253012
- F1253018
- F1253030
- F1253033

- F1256001
- F1256006
- F1256012
- F1256018
- F1256030
- F1256033

3000K

H 200 mm

- F1251001
- F1251006
- F1251012
- F1251018
- F1251030
- F1251033

- F1254001
- F1254006
- F1254012
- F1254018
- F1254030
- F1254033

- F1257001
- F1257006
- F1257012
- F1257018
- F1257030
- F1257033

4000K

H 200 mm

- F1252001
- F1252006
- F1252012
- F1252018
- F1252030
- F1252033

- F1255001
- F1255006
- F1255012
- F1255018
- F1255030
- F1255033

- F1258001
- F1258006
- F1258012
- F1258018
- F1258030
- F1258033

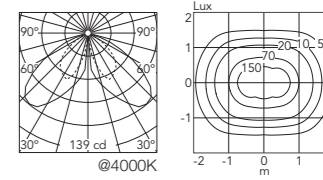
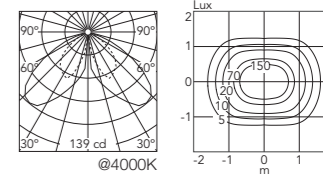
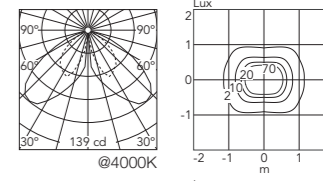

Casting T 150

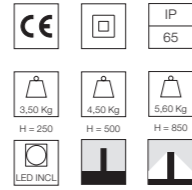
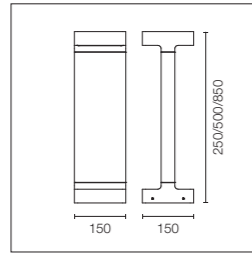

Alimentazione elettrica
220/240V integrata. Versione
110V a richiesta.

220/240V power supply
integrated. Version 110V upon
request.

Power Led: 21W - 2x1080 lm ≠ FIXT 2x565 lm - 2700K/CRI 80 - 220-240V / 21W - 2x1170 lm ≠ FIXT 2x613 lm - 3000K/CRI 80 - 220-240V /
21W - 2x1260 lm ≠ FIXT 2x660 lm - 4000K/CRI 80 - 220-240V

2700K

H 250 mm - Non Dimmable

- F1270001
- F1270006
- F1270012
- F1270018
- F1270030
- F1270033
- F1270001-310
- F1270006-310
- F1270012-310
- F1270018-310
- F1270030-310
- F1270033-310

Dali

- F1270001-300
- F1270006-300
- F1270012-300
- F1270018-300
- F1270030-300
- F1270033-300

2700K

H 500 mm - Non Dimmable

- F1273001
- F1273006
- F1273012
- F1273018
- F1273030
- F1273033
- F1273001-310
- F1273006-310
- F1273012-310
- F1273018-310
- F1273030-310
- F1273033-310

Dali

- F1273001-300
- F1273006-300
- F1273012-300
- F1273018-300
- F1273030-300
- F1273033-300

2700K

H 850 mm - Non Dimmable

- F1276001
- F1276006
- F1276012
- F1276018
- F1276030
- F1276033
- F1276001-310
- F1276006-310
- F1276012-310
- F1276018-310
- F1276030-310
- F1276033-310

Dali

- F1276001-300
- F1276006-300
- F1276012-300
- F1276018-300
- F1276030-300
- F1276033-300

3000K

H 250 mm - Non Dimmable

- F1271001
- F1271006
- F1271012
- F1271018
- F1271030
- F1271033
- F1271001-310
- F1271006-310
- F1271012-310
- F1271018-310
- F1271030-310
- F1271033-310

Dali

- F1271001-300
- F1271006-300
- F1271012-300
- F1271018-300
- F1271030-300
- F1271033-300

3000K

H 500 mm - Non Dimmable

- F1274001
- F1274006
- F1274012
- F1274018
- F1274030
- F1274033
- F1274001-310
- F1274006-310
- F1274012-310
- F1274018-310
- F1274030-310
- F1274033-310

Dali

- F1274001-300
- F1274006-300
- F1274012-300
- F1274018-300
- F1274030-300
- F1274033-300

3000K

H 850 mm - Non Dimmable

- F1277001
- F1277006
- F1277012
- F1277018
- F1277030
- F1277033
- F1277001-310
- F1277006-310
- F1277012-310
- F1277018-310
- F1277030-310
- F1277033-310

Dali

- F1277001-300
- F1277006-300
- F1277012-300
- F1277018-300
- F1277030-300
- F1277033-300

4000K

H 250 mm - Non Dimmable

- F1272001
- F1272006
- F1272012
- F1272018
- F1272030
- F1272033
- F1272001-310
- F1272006-310
- F1272012-310
- F1272018-310
- F1272030-310
- F1272033-310

Dali

- F1272001-300
- F1272006-300
- F1272012-300
- F1272018-300
- F1272030-300
- F1272033-300

4000K

H 500 mm - Non Dimmable

- F1275001
- F1275006
- F1275012
- F1275018
- F1275030
- F1275033
- F1275001-310
- F1275006-310
- F1275012-310
- F1275018-310
- F1275030-310
- F1275033-310

Dali

- F1275001-300
- F1275006-300
- F1275012-300
- F1275018-300
- F1275030-300
- F1275033-300

4000K

H 850 mm - Non Dimmable

- F1278001
- F1278006
- F1278012
- F1278018
- F1278030
- F1278033
- F1278001-310
- F1278006-310
- F1278012-310
- F1278018-310
- F1278030-310
- F1278033-310

Dali

- F1278001-300
- F1278006-300
- F1278012-300
- F1278018-300
- F1278030-300
- F1278033-300

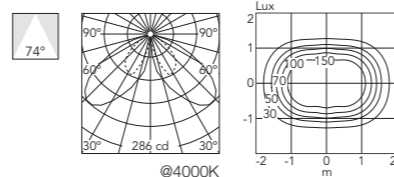
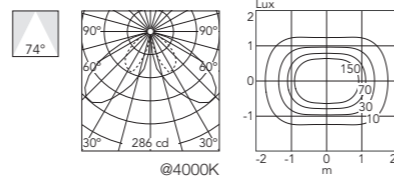
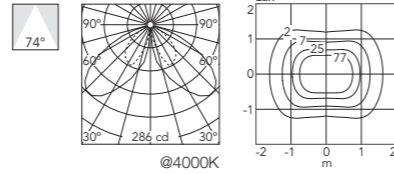

Casting C/T: Accessori / Accessories

Piastra tirafondi.

Base plate with bolt.

Casting 100

F1208000

Casting 150

F1207000



Sistema di giunzione IP68
H2O Stop anti-condensa a
3/4 vie 4 poli. (Ø5,5÷12mm
cavo).

3/4 way terminal block
4 poles IP68 H2O Stop.
(ø5,5÷12mm cable).

F990C010000



Dispositivo di protezione
per il sovraccarico. 240 Vac.
Corrente massima di scarica
10KA (8/29us). Massima
corrente operativa 5A. Adatto
per la connessione in serie.
IP66.

Surge protection device.
275Vac. Maximum discharge
current 10KA (8/20us).
Maximum operating current
5A. Suitable for series
connection. IP66.

F990E00A000

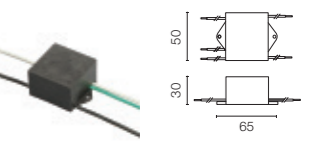

Walkstick / Wallstick

Designed by Antonio Citterio





Walkstick 2 Double



Walkstick Pipe

Famiglia / Family

Wallstick



Power Led

2,5W
185 lm - 2700K/CRI 80
199 lm - 3000K/CRI 80
212 lm - 4000K/CRI 80

Walkstick Pipe



Power Led

7W
483 lm - 2700K/CRI 80
496 lm - 3000K/CRI 80
529 lm - 4000K/CRI 80

Walkstick



Power Led

6W
333 lm - 2700K/CRI 80
358 lm - 3000K/CRI 80
382 lm - 4000K/CRI 80

Walkstick Double



Power Led

8,5W
333+185 lm - 2700K/CRI 80
358+199 lm - 3000K/CRI 80
382+212 lm - 4000K/CRI 80

Colori / Colours



01 White



06 Grey



12 Forest Green



18 Deep Brown



30 Black



33 Anthracite

Walkstick

186

Descrizione

Walkstick Pipe

Collezione di paletti per esterno con sorgente luminosa a LED e testa tubolare orientabile 350° sull'asse verticale e 350° sull'asse orizzontale. Disponibili in due differenti altezze. Lo stelo e la testa sono realizzati in alluminio estruso, la base in alluminio pressofuso a basso contenuto di rame. Disponibile in differenti finiture con un rivestimento a doppio strato con polveri secondo lo standard QUALICOAT. Il primo strato di polvere epossidica dà resistenza chimica e meccanica, il secondo strato di finitura di polvere poliestere assicura resistenza ai raggi UV ed agli agenti atmosferici corrosivi. Le superfici verniciate sono trattate con lavaggi alcalini e acidi, risciacquate con acqua demineralizzata e sottoposte a un trattamento di conversione chimica per proteggere contro l'ossidazione.

Le viterie di fissaggio sono in acciaio inox AISI 316L.

Diffusore in vetro acidato per garantire una diffusione uniforme della luce a terra.

L'apparecchio è fornito con uno spezzone di cavo uscente in neoprene.

Può essere installato facilmente a terra su qualsiasi pavimento con tasselli, oppure utilizzando l'accessorio dedicato cassaforma per rendere la base del prodotto totalmente solidale con la pavimentazione.

Walkstick

Collezione di paletti per esterno con sorgente luminosa a LED e testa svasata orientabile 350° sull'asse verticale. Disponibili in due differenti altezze combinate alla versione con una luce o due luci.

Lo stelo è realizzato in alluminio estruso, la base e la testa in alluminio pressofuso EN AB-47100 a basso contenuto di rame.

Disponibile in differenti finiture con un rivestimento a doppio strato con polveri secondo lo standard QUALICOAT. Il primo strato di polvere epossidica dà resistenza chimica e meccanica, il secondo strato di finitura di polvere poliestere assicura resistenza ai raggi UV ed agli agenti atmosferici corrosivi. Le superfici verniciate sono trattate con lavaggi alcalini e acidi, risciacquate con acqua demineralizzata e sottoposte a un trattamento di conversione chimica per proteggere contro l'ossidazione.

Le viterie di fissaggio sono in acciaio inox AISI 316L.

Diffusore in vetro microtexturizzato per garantire una distribuzione omogenea della luce a terra.

Può essere installato facilmente a terra su qualsiasi pavimento con tasselli, oppure utilizzando l'accessorio dedicato cassaforma per rendere la base del prodotto totalmente solidale con la pavimentazione.

Wallstick

Apparecchio segnapasso a parete per esterno con sorgente luminosa a LED e testa svasata orientabile 350° sull'asse verticale. Il corpo apparecchio è realizzato in alluminio pressofuso a basso contenuto di rame.

Disponibile in differenti finiture con un rivestimento a doppio strato con polveri secondo lo standard QUALICOAT. Il primo strato di polvere epossidica dà resistenza chimica e meccanica, il secondo strato di finitura di polvere poliestere assicura resistenza ai raggi UV ed agli agenti atmosferici corrosivi. Le superfici verniciate sono trattate con lavaggi alcalini e acidi, risciacquate con acqua demineralizzata e sottoposte a un trattamento di conversione chimica per proteggere contro l'ossidazione.

Le viterie di fissaggio sono in acciaio inox AISI 316L.

Diffusore in vetro microtexturizzato per garantire una distribuzione omogenea della luce a terra.

L'apparecchio è fornito con due cavi di alimentazione uscenti L 200mm e con un kit per la connessione a tenuta IP.

L'alimentatore elettrico a 24V può essere installato in remoto. Per una installazione più agevole è disponibile la cassaforma opzionale (scatola di derivazione 3 moduli modello 503)

187

Walkstick

Description

Walkstick Pipe

Collection of outdoor poles with LED light source and tubular head that can be adjusted 350° on the vertical and horizontal axes. Available in two different heights.

The stem and head are made of extruded aluminium; the base is made of die-cast aluminium with low copper content.

Available in different finishes with a double layer of powder coating according to the QUALICOAT standard. The first layer of epoxy powder confers chemical and mechanical resistance. The second layer, a polyester powder finish, ensures resistance to UV rays and corrosive atmospheric agents. The painted surfaces are treated with alkilene and acid washes, rinsed with demineralized water, and subjected to chemical conversion treatment to protect against rust. The anchoring hardware is made of AISI 316L stainless steel.

Diffuser made of acid-etched glass to guarantee a uniform wash of light on the ground.

The unit is supplied with a length of neoprene cable.

The unit may be easily installed on any flooring on the ground with anchors, or with the dedicated installation box to completely integrate the base of the product with the pavement.

Walkstick

Collection of outdoor poles with LED light source and tubular head that can be adjusted vertically 350°. Available in two different heights combined with the one- or two-light version. The stem is made of extruded aluminium; the base and head are made of EN AB-47100 die-cast aluminium with low copper content.

Available in different finishes with a double layer of powder coating according to the QUALICOAT standard. The first layer of epoxy powder confers chemical and mechanical resistance. The second layer, a polyester powder finish, ensures resistance to UV rays and corrosive atmospheric agents. The painted surfaces are treated with alkilene and acid washes, rinsed with demineralized water, and subjected to chemical conversion treatment to protect against rust. The anchoring hardware is made of AISI 316L stainless steel.

Diffuser in micro-textured glass to guarantee uniform light distribution on the ground.

The unit may be easily installed on any flooring on the ground with anchors, or with the dedicated installation box to completely integrate the base of the product with the pavement.

Wallstick

Wall-mounted outdoor footpath lights with LED light source and flared head that can be adjusted vertically 350°. The body is made of die-cast aluminium with low copper content.

Available in different finishes with a double layer of powder coating according to the QUALICOAT standard. The first layer of epoxy powder confers chemical and mechanical resistance. The second layer, a polyester powder finish, ensures resistance to UV rays and corrosive atmospheric agents. The painted surfaces are treated with alkilene and acid washes, rinsed with demineralized water, and subjected to chemical conversion treatment to protect against rust. The anchoring hardware is made of AISI 316L stainless steel. Diffuser in micro-textured glass to guarantee uniform light distribution on the ground.

The light comes with two 2-m power cables and with a kit for IP-rated connection.

The 24V electrical power supply can be installed remotely. For easier installation, an optional box (sold separately) is available (3-module junction box, model 503).



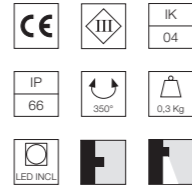
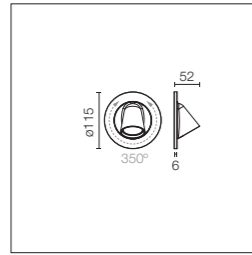

Sorgente luminosa a LED inclusa. Testa orientabile 350° sull'asse verticale. Alimentazione elettrica remota a 24V da ordinare separatamente. Apparecchio fornito con due cavi di alimentazione uscenti L 200mm e con un kit per la connessione a tenuta IP. L'alimentatore può essere installato remoto (cassaforma non necessaria) o alloggiato posteriormente all'apparecchio mediante apposita cassaforma opzionale.

LED light source included. Head adjustable 350° on the vertical axis. Remote 24V electrical power unit sold separately. Unit comes with two 200-mm-long outgoing power cables and a kit for IP-rated connection. The power supply may be installed remotely (installation box not necessary) or housed behind the unit with the optional installation box.

Power Led: 2,5W - 264 lm ≠ FIXT 185 lm - 2700K/CRI 80 - 24V / 2,5W - 283 lm ≠ FIXT 199 lm - 3000K/CRI 80 - 24V / 2,5W - 303 lm ≠ FIXT 212 lm - 4000K/CRI 80 - 24V

2700K

- PWM Dimmable
- F010A20H001
- F010A20H006
- F010A20H012
- F010A20H018
- F010A20H030
- F010A20H033

3000K

- PWM Dimmable
- F010A30H001
- F010A30H006
- F010A30H012
- F010A30H018
- F010A30H030
- F010A30H033

4000K

- PWM Dimmable
- F010A40H001
- F010A40H006
- F010A40H012
- F010A40H018
- F010A40H030
- F010A40H033

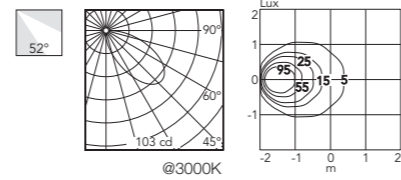

* Numero massimo di apparecchi per alimentatore / Maximum number of luminaires per power supply.

Numero massimo di apparecchi per alimentatore (Vin220÷240). Dati indicativi da verificare con le specifiche condizioni di installazione.	Maximum number of luminaires per power supply. (220÷240 V). These data must be checked taking into account the specific installation conditions.	Non Dimmable		Dimmable	
		Acc. RF25754	1	Acc. F990B02A000	7
		Acc. RF25748	1	Acc. F990B03A000	7
		Acc. RF25747	2	Acc. F990B04A000	13
		Acc. RF25757	2	Acc. F990B05A000	13
		Acc. F990B23AZ00	7		
		Acc. RF25755	9		
		Acc. RF25749	13		

Fissaggio a Parete / Installation on Wall

Option 1

Senza cassaforma / Without recessed box installation.

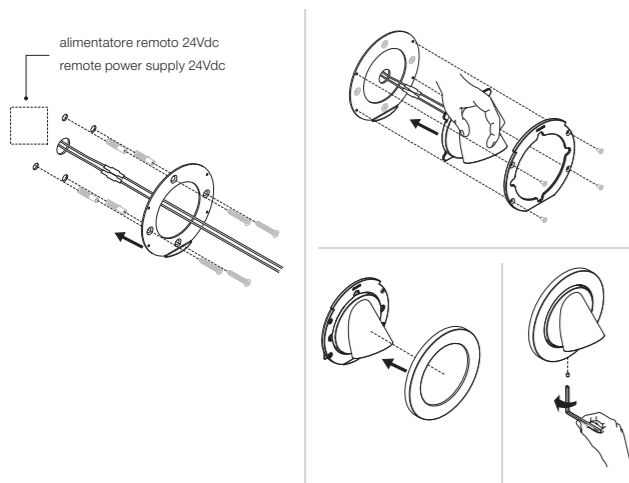

Option 2

Con cassaforma / Recessed box installation.

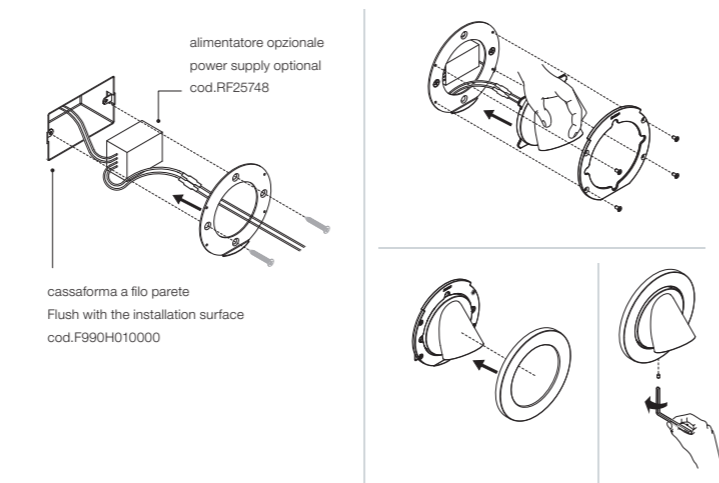

Wallstick: Accessori / Accessories

Scatola di derivazione da incasso 3 moduli (modello 503) 106x75mm H 55mm.	Recessed 3-module junction box (model 503) 106 mm x 75 mm H 55 mm.	F990H010000		
Sistema di giunzione IP68 a 2 vie 2 poli. (Ø4÷6,9mm cavo).	2 way terminal block 2 poles IP68. (Ø4÷6,9mm cable).	F990C050000		
Non può essere alloggiato nella scatola per incasso.	It can't be placed in the recessed box for installation.			

Wallstick: Power Supply Dimmable

Alimentatore 120/270Vac / 24Vdc. 1-10V PWM control. IP67.	Power supply 120/270Vac / 24Vdc. 1-10V PWM control. IP67.	35W *F990B02A000 70W *F990B04A000		
Alimentatore 120/270Vac / 24Vdc. DALI PWM control. IP67.	Power supply 120/270Vac / 24Vdc. DALI PWM control. IP67.	35W *F990B03A000 70W *F990B05A000		
Interfaccia di controllo 1-10V PWM 24Vdc 120W. IP67. Fonte di alimentazione non inclusa.	1-10V PWM control interface 24Vdc 120W. IP67. Power supply not included.	F990B00A000		
Interfaccia di controllo DALI PWM 24Vdc 120W. IP67. Fonte di alimentazione non inclusa.	DALI PWM control interface 24Vdc 120W. IP67. Power supply not included.	F990B01A000		

Wallstick: Power Supply Non Dimmable

Alimentatore 24V 8W / 110-240V IP20 Classe II selv.	Power supply 24V 8W / 110-240V IP20 Class II selv.	*RF25754		
Alimentatore 24V 8W / 110-240V IP65 Classe II selv.	Power supply 24V 8W / 110-240V IP65 Class II selv.	*RF25748		
Alimentatore 24V 10W / 110-240V IP20 Classe II selv.	Power supply 24V 10W / 110-240V IP20 Class II selv.	*RF25747		
Alimentatore 24V 10W / 110-240V IP67 Classe II selv.	Power supply 24V 10W / 110-240V IP67 Class II selv.	*RF25757		
Alimentatore 24Vdc 35W / 120-270V IP67 Classe II selv.	Power supply 24Vdc 35W / 120-270V IP67 Class II selv.	*F990B23AZ00		
Alimentatore 24Vdc 50W / 120-240V IP67 Classe II selv.	Power supply 24Vdc 50W / 120-240V IP67 Class II selv.	*RF25755		
Alimentatore 24Vdc 70W / 220-240V IP67 Classe II selv.	Power supply 24Vdc 70W / 220-240V IP67 Class II selv.	*RF25749		

Walkstick Pipe 1

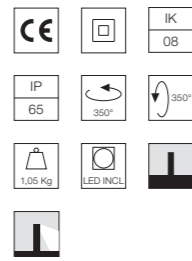
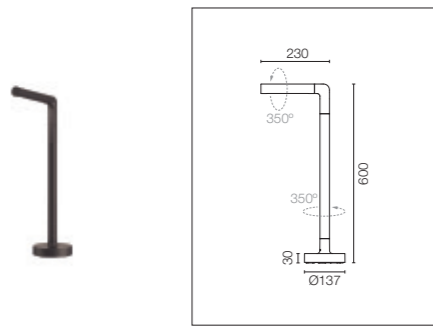

Alimentazione elettrica 220-240V inclusa. Pronto per l'installazione su superficie solida.
Box per l'installazione a terra da ordinare separatamente.
Include un sistema di giunzione IP68 H₂O Stop anti-condensa a 2 vie 4 poli.
Versione 110V a richiesta.

220-240V power supply included. Ready for installation on solid surface. Box for ground installation to be ordered separately.
Included 2 way terminal block 4 poles IP68 H₂O Stop.
Version 110V upon request.

Power Led: 7W - 622 lm ≠ FIXT 483 lm - 2700K/CRI 80 - 220-240V / 7W - 648 lm ≠ FIXT 496 lm - 3000K/CRI 80 - 220-240V / 7W - 693 lm ≠ FIXT 529 lm - 4000K/CRI 80 - 220-240V

2700K

- Non Dimmable
- F010H21A001
 - F010H21A006
 - F010H21A012
 - F010H21A018
 - F010H21A030
 - F010H21A033
 - F010H21B001
 - F010H21B006
 - F010H21B012
 - F010H21B018
 - F010H21B030
 - F010H21B033

3000K

- Non Dimmable
- F010H31A001
 - F010H31A006
 - F010H31A012
 - F010H31A018
 - F010H31A030
 - F010H31A033
 - F010H31B001
 - F010H31B006
 - F010H31B012
 - F010H31B018
 - F010H31B030
 - F010H31B033

4000K

- Non Dimmable
- F010H41A001
 - F010H41A006
 - F010H41A012
 - F010H41A018
 - F010H41A030
 - F010H41A033
 - F010H41B001
 - F010H41B006
 - F010H41B012
 - F010H41B018
 - F010H41B030
 - F010H41B033

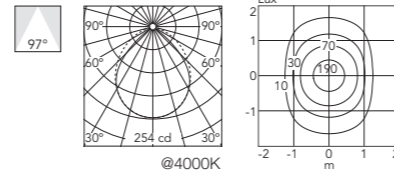

Walkstick 1

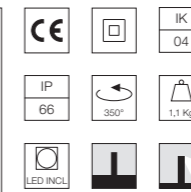
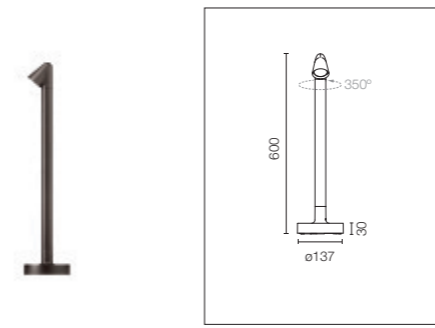

Sorgente luminosa a LED inclusa. Testa orientabile 350° sull'asse verticale e 350° sull'asse orizzontale.
Alimentazione elettrica 220-240V ON/OFF integrata.
Dotato di uno spezzone di cavo uscente in neoprene e un sistema di giunzione IP68 H₂O Stop anti-condensa a 2 vie.
Cassaforma per l'installazione a terra opzionale da ordinare separatamente.
Versione 110V a richiesta.

LED light source included. Head adjustable 350° on both the vertical and horizontal axes.
Integrated 220-240V ON/OFF electrical power. Equipped with a length of neoprene cable and an IP68 2-way anti-condensation H₂O stop seal system. Box for ground installation sold separately.
110V version by request.

Power Led: 6W - 502 lm ≠ FIXT 333 lm - 2700K/CRI 80 - 220-240V / 6W - 539 lm ≠ FIXT 358 lm - 3000K/CRI 80 - 220-240V / 6W - 577 lm ≠ FIXT 382 lm - 4000K/CRI 80 - 220-240V

2700K

- Non Dimmable
- F010B21A001
 - F010B21A006
 - F010B21A012
 - F010B21A018
 - F010B21A030
 - F010B21A033
 - F010B21B001
 - F010B21B006
 - F010B21B012
 - F010B21B018
 - F010B21B030
 - F010B21B033

3000K

- Non Dimmable
- F010B31A001
 - F010B31A006
 - F010B31A012
 - F010B31A018
 - F010B31A030
 - F010B31A033
 - F010B31B001
 - F010B31B006
 - F010B31B012
 - F010B31B018
 - F010B31B030
 - F010B31B033

4000K

- Non Dimmable
- F010B41A001
 - F010B41A006
 - F010B41A012
 - F010B41A018
 - F010B41A030
 - F010B41A033
 - F010B41B001
 - F010B41B006
 - F010B41B012
 - F010B41B018
 - F010B41B030
 - F010B41B033

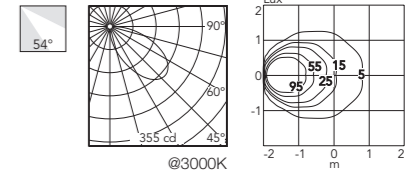

Walkstick Pipe 2

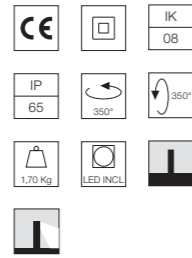
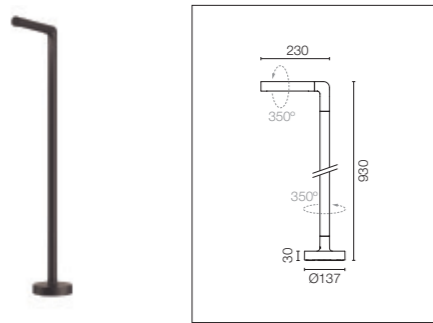

Alimentazione elettrica 220-240V inclusa. Pronto per l'installazione su superficie solida.
Box per l'installazione a terra da ordinare separatamente.
Include un sistema di giunzione IP68 H₂O Stop anti-condensa a 2 vie 4 poli.
Versione 110V a richiesta.

220-240V power supply included. Ready for installation on solid surface. Box for ground installation to be ordered separately.
Included 2 way terminal block 4 poles IP68 H₂O Stop.
Version 110V upon request.

Power Led: 7W - 622 lm ≠ FIXT 483 lm - 2700K/CRI 80 - 220-240V / 7W - 648 lm ≠ FIXT 496 lm - 3000K/CRI 80 - 220-240V / 7W - 693 lm ≠ FIXT 529 lm - 4000K/CRI 80 - 220-240V

2700K

- Non Dimmable
- F010J21A001
 - F010J21A006
 - F010J21A012
 - F010J21A018
 - F010J21A030
 - F010J21A033
 - F010J21B001
 - F010J21B006
 - F010J21B012
 - F010J21B018
 - F010J21B030
 - F010J21B033
- Dali
- F010J21D001
 - F010J21D006
 - F010J21D012
 - F010J21D018
 - F010J21D030
 - F010J21D033

3000K

- Non Dimmable
- F010J31A001
 - F010J31A006
 - F010J31A012
 - F010J31A018
 - F010J31A030
 - F010J31A033
 - F010J31B001
 - F010J31B006
 - F010J31B012
 - F010J31B018
 - F010J31B030
 - F010J31B033
- Dali
- F010J31D001
 - F010J31D006
 - F010J31D012
 - F010J31D018
 - F010J31D030
 - F010J31D033

4000K

- Non Dimmable
- F010J41A001
 - F010J41A006
 - F010J41A012
 - F010J41A018
 - F010J41A030
 - F010J41A033
 - F010J41B001
 - F010J41B006
 - F010J41B012
 - F010J41B018
 - F010J41B030
 - F010J41B033
- Dali
- F010J41D001
 - F010J41D006
 - F010J41D012
 - F010J41D018
 - F010J41D030
 - F010J41D033

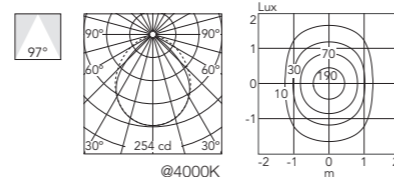

Walkstick 2

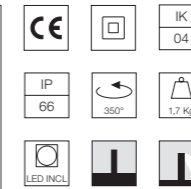
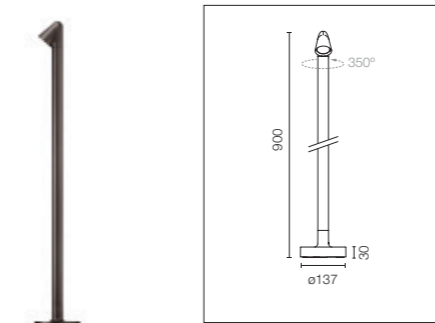

Sorgente luminosa a LED inclusa. Testa orientabile 350° sull'asse verticale e 350° sull'asse orizzontale.
Alimentazione elettrica 220-240V ON/OFF e dimmabile 1-10V o DALI integrata. Dotato di uno spezzone di cavo uscente in neoprene e un sistema di giunzione IP68 H₂O Stop anti-condensa a 2 vie.
Cassaforma per l'installazione a terra opzionale da ordinare separatamente.
Versione 110V a richiesta.

LED light source included. Head adjustable 350° on both the vertical and horizontal axes.
Integrated 220-240V ON/OFF and 1-10V or DALI dimmable electrical power. Equipped with a length of neoprene cable and an IP68 2-way anti-condensation H₂O stop seal system. Box for ground installation sold separately.
110V version by request.

Power Led: 6W - 502 lm ≠ FIXT 333 lm - 2700K/CRI 80 - 220-240V / 6W - 539 lm ≠ FIXT 358 lm - 3000K/CRI 80 - 220-240V / 6W - 577 lm ≠ FIXT 382 lm - 4000K/CRI 80 - 220-240V

2700K

- Non Dimmable
- F010B22A001
 - F010B22A006
 - F010B22A012
 - F010B22A018
 - F010B22A030
 - F010B22A033
 - F010B22B001
 - F010B22B006
 - F010B22B012
 - F010B22B018
 - F010B22B030
 - F010B22B033
- Dali
- F010B22D001
 - F010B22D006
 - F010B22D012
 - F010B22D018
 - F010B22D030
 - F010B22D033

3000K

- Non Dimmable
- F010B32A001
 - F010B32A006
 - F010B32A012
 - F010B32A018
 - F010B32A030
 - F010B32A033
 - F010B32B001
 - F010B32B006
 - F010B32B012
 - F010B32B018
 - F010B32B030
 - F010B32B033
- Dali
- F010B32D001
 - F010B32D006
 - F010B32D012
 - F010B32D018
 - F010B32D030
 - F010B32D033

4000K

- Non Dimmable
- F010B42A001
 - F010B42A006
 - F010B42A012
 - F010B42A018
 - F010B42A030
 - F010B42A033
 - F010B42B001
 - F010B42B006
 - F010B42B012
 - F010B42B018
 - F010B42B030
 - F010B42B033
- Dali
- F010B42D001
 - F010B42D006
 - F010B42D012
 - F010B42D018
 - F010B42D030
 - F010B42D033

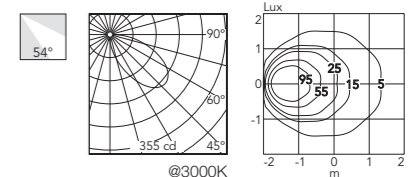

Walkstick 2 Double

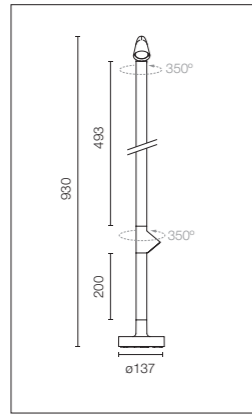

Doppia sorgente luminosa a LED inclusa. Teste orientabili indipendentemente 350° sull'asse verticale e 350° sull'asse orizzontale. Alimentazione elettrica 220-240V ON/OFF e dimmabile 1-10V o DALI integrata. Dotato di uno spezzone di cavo uscente in neoprene e un sistema di giunzione IP68 H₂O Stop anti-condensa a 2 vie. Cassaforma per l'installazione a terra opzionale da ordinare separatamente. Versione 110V a richiesta

Dual LED light source included. Heads independently adjustable 350° on both the vertical and horizontal axes. Integrated 220-240V ON/OFF and 1-10V or DALI dimmable electrical power. Equipped with a length of neoprene cable and an IP68 2-way anti-condensation H₂O stop seal system. Box for ground installation sold separately. 110V version by request.

Power Led: 8,5W - 502+264 lm ≠ FIXT 333+185 lm - 2700K/CRI 80 - 220-240V / 8,5W - 539+283 lm ≠ FIXT 358+199 lm - 3000K/CRI 80 - 220-240V / 8,5W - 577+303 lm ≠ FIXT 382+212 lm - 4000K/CRI 80 - 220-240V

2700K

Non Dimmable

- F010C22A001
- F010C22A006
- F010C22A012
- F010C22A018
- F010C22A030
- F010C22A033

1-10V

- F010C22B001
- F010C22B006
- F010C22B012
- F010C22B018
- F010C22B030
- F010C22B033

Dali

- F010C22D001
- F010C22D006
- F010C22D012
- F010C22D018
- F010C22D030
- F010C22D033

3000K

Non Dimmable

- F010C32A001
- F010C32A006
- F010C32A012
- F010C32A018
- F010C32A030
- F010C32A033

1-10V

- F010C32B001
- F010C32B006
- F010C32B012
- F010C32B018
- F010C32B030
- F010C32B033

Dali

- F010C32D001
- F010C32D006
- F010C32D012
- F010C32D018
- F010C32D030
- F010C32D033

4000K

Non Dimmable

- F010C42A001
- F010C42A006
- F010C42A012
- F010C42A018
- F010C42A030
- F010C42A033

1-10V

- F010C42B001
- F010C42B006
- F010C42B012
- F010C42B018
- F010C42B030
- F010C42B033

Dali

- F010C42D001
- F010C42D006
- F010C42D012
- F010C42D018
- F010C42D030
- F010C42D033

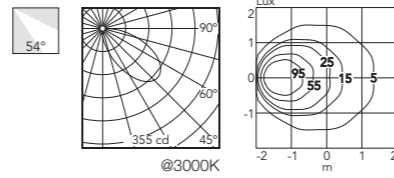

Walkstick: Accessori / Accessories

Cassaforma per l'installazione a terra. Box for ground installation.

F001Z020000

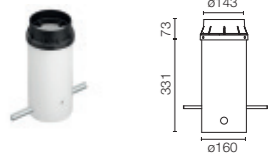

Dispositivo di protezione per il sovraccarico. 240Vac. Corrente massima di scarica 10KA (8/29us). Massima corrente operativa 5A. Adatto per la connessione in serie. IP66.

Surge protection device. 275Vac. Maximum discharge current 10KA (8/20us). Maximum operating current 5A. Suitable for series connection. IP66.

F990E00A000

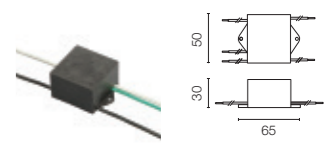

Belvedere



Designed by Antonio Citterio assistant Toan Nguyen



Belvedere Clove



Belvedere Spot

Famiglia / Family

Belvedere Clove



Power Led

8,4W

631 lm - 2700K/CRI 80

657 lm - 3000K/CRI 80

703 lm - 4000K/CRI 80

Belvedere Spot



Power Led

6W

425 lm - 2700K/CRI 80

440 lm - 3000K/CRI 80

473 lm - 4000K/CRI 80

Belvedere Spot Wall



Power Led

6W

425 lm - 2700K/CRI 80

440 lm - 3000K/CRI 80

473 lm - 4000K/CRI 80

Descrizione / Description

Belvedere Spot

Famiglia di apparecchi LED per illuminazione da esterno orientabili (doppia rotazione, asse verticale ed orizzontale) per installazione a terra (a pavimento o interrato) e con scatola di alimentazione integrata.

Belvedere Spot Wall

Apparecchio di illuminazione da esterno composto da un proiettore orientabile a $350^{\circ}\pm 5^{\circ}$ sull'asse orizzontale per installazione a parete e con scatola di alimentazione integrata.

Belvedere Clove

Famiglia di apparecchi di illuminazione da esterno composta da versioni con palo di due differenti lunghezze per installazione a terra (a pavimento o interrato) e con scatola di alimentazione integrata.

Si raccomanda l'uso di un sistema di connessione con un grado di protezione maggiore o uguale al grado di protezione dell'apparecchio.

Belvedere Spot

Family of adjustable outdoor LED lighting luminaires (double rotation, vertical and horizontal axle) suitable for floor installations (ground or buried) and with integrated power supply box.

Belvedere Spot Wall

Outdoor luminaire consisting of an adjustable projector for up to $350^{\circ}\pm 5^{\circ}$ on the horizontal axle suitable for wall installations and with integrated power supply box.

Belvedere Clove

Family of outdoor products consisting of luminaires with a pole of two different heights and suitable for floor installations (ground or buried) and with integrated power supply box.

We recommend using a connection system with a degree of protection greater than or equal to the degree of protection of the luminaire.

Colori / Colours



01 White



06 Grey



12 Forest Green



18 Deep Brown



30 Black



33 Anthracite

Belvedere Clove 1

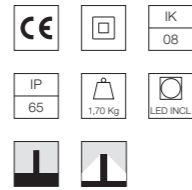
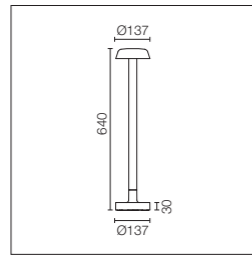

Alimentazione elettrica 220-240V inclusa. Pronto per l'installazione su superficie solida.
Box per l'installazione a terra da ordinare separatamente.
Include un sistema di giunzione IP68 H2O Stop anti-condensa a 2 vie 4 poli.
Versione 110V a richiesta.

220-240V power supply included. Ready for installation on solid surface. Box for ground installation to be ordered separately.
Included 2 way terminal block 4 poles IP68 H2O Stop.
Version 110V upon request.

Power Led: 8,4W - 783 lm ≠ FIXT 631 lm - 2700K/CRI 80 - 220-240V / 8,4W - 816 lm ≠ FIXT 657 lm - 3000K/CRI 80 - 220-240V / 8,4W - 873 lm ≠ FIXT 703 lm - 4000K/CRI 80 - 220-240V

2700K

Non Dimmable

- F001A21A001
- F001A21A006
- F001A21A012
- F001A21A018
- F001A21A030
- F001A21A033

1-10V

- F001A21B001
- F001A21B006
- F001A21B012
- F001A21B018
- F001A21B030
- F001A21B033

Dali

- F001A21D001
- F001A21D006
- F001A21D012
- F001A21D018
- F001A21D030
- F001A21D033

3000K

Non Dimmable

- F001A31A001
- F001A31A006
- F001A31A012
- F001A31A018
- F001A31A030
- F001A31A033

1-10V

- F001A31B001
- F001A31B006
- F001A31B012
- F001A31B018
- F001A31B030
- F001A31B033

Dali

- F001A31D001
- F001A31D006
- F001A31D012
- F001A31D018
- F001A31D030
- F001A31D033

4000K

Non Dimmable

- F001A41A001
- F001A41A006
- F001A41A012
- F001A41A018
- F001A41A030
- F001A41A033

1-10V

- F001A41B001
- F001A41B006
- F001A41B012
- F001A41B018
- F001A41B030
- F001A41B033

Dali

- F001A41D001
- F001A41D006
- F001A41D012
- F001A41D018
- F001A41D030
- F001A41D033

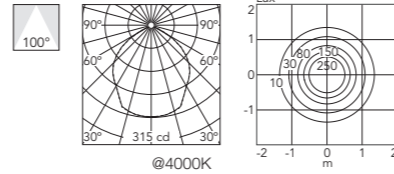

Belvedere Clove 2

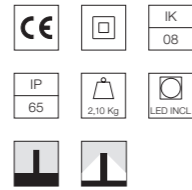
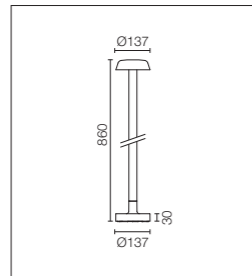

Alimentazione elettrica 220-240V inclusa. Pronto per l'installazione su superficie solida.
Box per l'installazione a terra da ordinare separatamente.
Include un sistema di giunzione IP68 H2O Stop anti-condensa a 2 vie 4 poli.
Versione 110V a richiesta.

220-240V power supply included. Ready for installation on solid surface. Box for ground installation to be ordered separately.
Included 2 way terminal block 4 poles IP68 H2O Stop.
Version 110V upon request.

Power Led: 8,4W - 783 lm ≠ FIXT 631 lm - 2700K/CRI 80 - 220-240V / 8,4W - 816 lm ≠ FIXT 657 lm - 3000K/CRI 80 - 220-240V / 8,4W - 873 lm ≠ FIXT 703 lm - 4000K/CRI 80 - 220-240V

2700K

Non Dimmable

- F001B21A001
- F001B21A006
- F001B21A012
- F001B21A018
- F001B21A030
- F001B21A033

1-10V

- F001B21B001
- F001B21B006
- F001B21B012
- F001B21B018
- F001B21B030
- F001B21B033

Dali

- F001B21D001
- F001B21D006
- F001B21D012
- F001B21D018
- F001B21D030
- F001B21D033

3000K

Non Dimmable

- F001B31A001
- F001B31A006
- F001B31A012
- F001B31A018
- F001B31A030
- F001B31A033

1-10V

- F001B31B001
- F001B31B006
- F001B31B012
- F001B31B018
- F001B31B030
- F001B31B033

Dali

- F001B31D001
- F001B31D006
- F001B31D012
- F001B31D018
- F001B31D030
- F001B31D033

4000K

Non Dimmable

- F001B41A001
- F001B41A006
- F001B41A012
- F001B41A018
- F001B41A030
- F001B41A033

1-10V

- F001B41B001
- F001B41B006
- F001B41B012
- F001B41B018
- F001B41B030
- F001B41B033

Dali

- F001B41D001
- F001B41D006
- F001B41D012
- F001B41D018
- F001B41D030
- F001B41D033

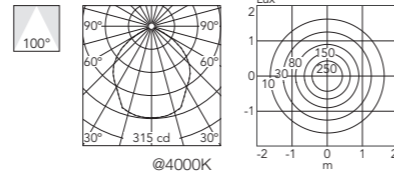

Belvedere Spot Floor 1

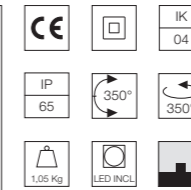
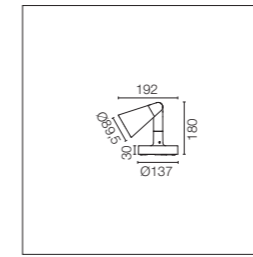

Alimentazione elettrica 220-240V inclusa. Pronto per l'installazione su superficie solida.
Box per l'installazione a terra da ordinare separatamente.
Include un sistema di giunzione IP68 H2O Stop. anti-condensa a 2 vie 4 poli.
Versione dimmerabile 24V disponibile su richiesta.

220-240V power supply included. Ready for installation on solid surface. Box for ground installation to be ordered separately.
Included 2 way terminal block 4 poles IP68 H2O Stop.
24V Dimmable version available on request.

Power Led: 6W - 513 lm ≠ *FIXT 425 lm - 2700K/CRI 80 - 220-240V / 6W - 530 lm ≠ *FIXT 440 lm - 3000K/CRI 80 - 220-240V / 6W - 570 lm ≠ *FIXT 473 lm - 4000K/CRI 80 - 220-240V / *FIXT lm = Spot Optic

2700K

Non Dimmable

- F001C21A001
- F001C21A006
- F001C21A012
- F001C21A018
- F001C21A030
- F001C21A033

2700K

Non Dimmable

- F001C22A001
- F001C22A006
- F001C22A012
- F001C22A018
- F001C22A030
- F001C22A033

2700K

Non Dimmable

- F001C23A001
- F001C23A006
- F001C23A012
- F001C23A018
- F001C23A030
- F001C23A033

3000K

Non Dimmable

- F001C31A001
- F001C31A006
- F001C31A012
- F001C31A018
- F001C31A030
- F001C31A033

3000K

Non Dimmable

- F001C32A001
- F001C32A006
- F001C32A012
- F001C32A018
- F001C32A030
- F001C32A033

3000K

Non Dimmable

- F001C33A001
- F001C33A006
- F001C33A012
- F001C33A018
- F001C33A030
- F001C33A033

4000K

Non Dimmable

- F001C41A001
- F001C41A006
- F001C41A012
- F001C41A018
- F001C41A030
- F001C41A033

4000K

Non Dimmable

- F001C42A001
- F001C42A006
- F001C42A012
- F001C42A018
- F001C42A030
- F001C42A033

4000K

Non Dimmable

- F001C43A001
- F001C43A006
- F001C43A012
- F001C43A018
- F001C43A030
- F001C43A033

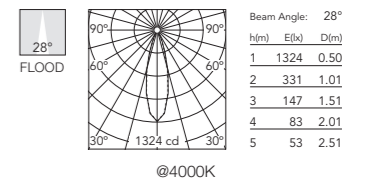
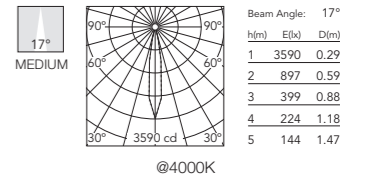
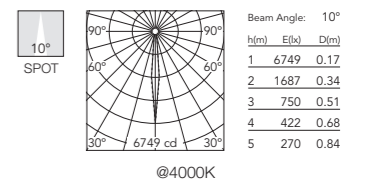

Belvedere Spot Floor 2

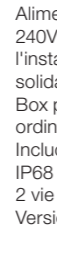
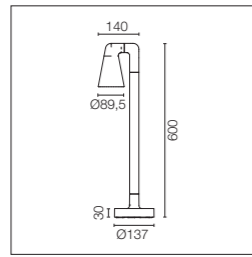

Alimentazione elettrica 220-240V inclusa. Pronto per l'installazione su superficie solida.
 Box per l'installazione a terra da ordinare separatamente.
 Include un sistema di giunzione IP68 H2O Stop anti-condensa a 2 vie 4 poli.
 Versione 110V a richiesta.

220-240V power supply included. Ready for installation on solid surface. Box for ground installation to be ordered separately.
 Included 2 way terminal block 4 poles IP68 H2O Stop.
 Version 110V upon request.

Power Led: 6W - 513 lm ≠ *FIXT 425 lm - 2700K/CRI 80 - 220-240V / 6W - 530 lm ≠ *FIXT 440 lm - 3000K/CRI 80 - 220-240V / 6W - 570 lm ≠ *FIXT 473 lm - 4000K/CRI 80 - 220-240V
 *FIXT lm = Spot Optic

2700K

- Non Dimmable
- F001D21A001
 - F001D21A006
 - F001D21A012
 - F001D21A018
 - F001D21A030
 - F001D21A033
- 1-10V
- F001D21B001
 - F001D21B006
 - F001D21B012
 - F001D21B018
 - F001D21B030
 - F001D21B033

3000K

- Non Dimmable
- F001D31A001
 - F001D31A006
 - F001D31A012
 - F001D31A018
 - F001D31A030
 - F001D31A033
- 1-10V
- F001D31B001
 - F001D31B006
 - F001D31B012
 - F001D31B018
 - F001D31B030
 - F001D31B033

4000K

- Non Dimmable
- F001D41A001
 - F001D41A006
 - F001D41A012
 - F001D41A018
 - F001D41A030
 - F001D41A033
- 1-10V
- F001D41B001
 - F001D41B006
 - F001D41B012
 - F001D41B018
 - F001D41B030
 - F001D41B033

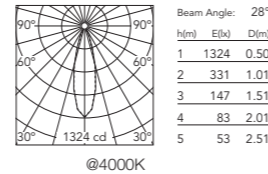
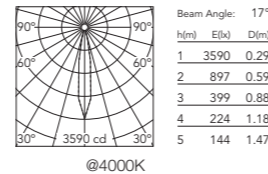
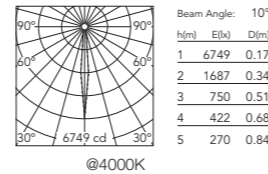

2700K

- Non Dimmable
- F001D22A001
 - F001D22A006
 - F001D22A012
 - F001D22A018
 - F001D22A030
 - F001D22A033
- 1-10V
- F001D22B001
 - F001D22B006
 - F001D22B012
 - F001D22B018
 - F001D22B030
 - F001D22B033

3000K

- Non Dimmable
- F001D32A001
 - F001D32A006
 - F001D32A012
 - F001D32A018
 - F001D32A030
 - F001D32A033
- 1-10V
- F001D32B001
 - F001D32B006
 - F001D32B012
 - F001D32B018
 - F001D32B030
 - F001D32B033

4000K

- Non Dimmable
- F001D42A001
 - F001D42A006
 - F001D42A012
 - F001D42A018
 - F001D42A030
 - F001D42A033
- 1-10V
- F001D42B001
 - F001D42B006
 - F001D42B012
 - F001D42B018
 - F001D42B030
 - F001D42B033

2700K

- Non Dimmable
- F001D23A001
 - F001D23A006
 - F001D23A012
 - F001D23A018
 - F001D23A030
 - F001D23A033
- 1-10V
- F001D23B001
 - F001D23B006
 - F001D23B012
 - F001D23B018
 - F001D23B030
 - F001D23B033

3000K

- Non Dimmable
- F001D33A001
 - F001D33A006
 - F001D33A012
 - F001D33A018
 - F001D33A030
 - F001D33A033
- 1-10V
- F001D33B001
 - F001D33B006
 - F001D33B012
 - F001D33B018
 - F001D33B030
 - F001D33B033

4000K

- Non Dimmable
- F001D43A001
 - F001D43A006
 - F001D43A012
 - F001D43A018
 - F001D43A030
 - F001D43A033
- 1-10V
- F001D43B001
 - F001D43B006
 - F001D43B012
 - F001D43B018
 - F001D43B030
 - F001D43B033

Belvedere Spot Floor 3

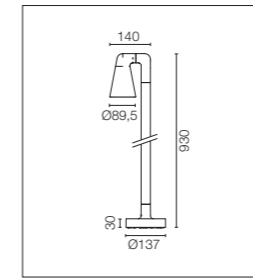

Alimentazione elettrica 220-240V inclusa. Pronto per l'installazione su superficie solida.
 Box per l'installazione a terra da ordinare separatamente.
 Include un sistema di giunzione IP68 H2O Stop anti-condensa a 2 vie 4 poli.
 Versione 110V a richiesta.

220-240V power supply included. Ready for installation on solid surface. Box for ground installation to be ordered separately.
 Included 2 way terminal block 4 poles IP68 H2O Stop.
 Version 110V upon request.

Power Led: 6W - 513 lm ≠ *FIXT 425 lm - 2700K/CRI 80 - 220-240V / 6W - 530 lm ≠ *FIXT 440 lm - 3000K/CRI 80 - 220-240V / 6W - 570 lm ≠ *FIXT 473 lm - 4000K/CRI 80 - 220-240V
 *FIXT lm = Spot Optic

2700K

- Non Dimmable
- F001E21A001
 - F001E21A006
 - F001E21A012
 - F001E21A018
 - F001E21A030
 - F001E21A033
- 1-10V
- F001E21B001
 - F001E21B006
 - F001E21B012
 - F001E21B018
 - F001E21B030
 - F001E21B033
- Dali
- F001E21D001
 - F001E21D006
 - F001E21D012
 - F001E21D018
 - F001E21D030
 - F001E21D033

3000K

- Non Dimmable
- F001E31A001
 - F001E31A006
 - F001E31A012
 - F001E31A018
 - F001E31A030
 - F001E31A033
- 1-10V
- F001E31B001
 - F001E31B006
 - F001E31B012
 - F001E31B018
 - F001E31B030
 - F001E31B033
- Dali
- F001E31D001
 - F001E31D006
 - F001E31D012
 - F001E31D018
 - F001E31D030
 - F001E31D033

4000K

- Non Dimmable
- F001E41A001
 - F001E41A006
 - F001E41A012
 - F001E41A018
 - F001E41A030
 - F001E41A033
- 1-10V
- F001E41B001
 - F001E41B006
 - F001E41B012
 - F001E41B018
 - F001E41B030
 - F001E41B033
- Dali
- F001E41D001
 - F001E41D006
 - F001E41D012
 - F001E41D018
 - F001E41D030
 - F001E41D033

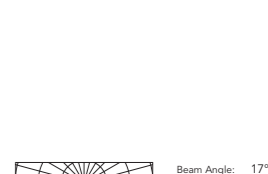
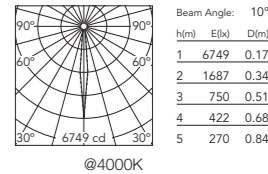

2700K

- Non Dimmable
- F001E22A001
 - F001E22A006
 - F001E22A012
 - F001E22A018
 - F001E22A030
 - F001E22A033
- 1-10V
- F001E22B001
 - F001E22B006
 - F001E22B012
 - F001E22B018
 - F001E22B030
 - F001E22B033
- Dali
- F001E22D001
 - F001E22D006
 - F001E22D012
 - F001E22D018
 - F001E22D030
 - F001E22D033

3000K

- Non Dimmable
- F001E32A001
 - F001E32A006
 - F001E32A012
 - F001E32A018
 - F001E32A030
 - F001E32A033
- 1-10V
- F001E32B001
 - F001E32B006
 - F001E32B012
 - F001E32B018
 - F001E32B030
 - F001E32B033
- Dali
- F001E32D001
 - F001E32D006
 - F001E32D012
 - F001E32D018
 - F001E32D030
 - F001E32D033

4000K

- Non Dimmable
- F001E42A001
 - F001E42A006
 - F001E42A012
 - F001E42A018
 - F001E42A030
 - F001E42A033
- 1-10V
- F001E42B001
 - F001E42B006
 - F001E42B012
 - F001E42B018
 - F001E42B030
 - F001E42B033
- Dali
- F001E42D001
 - F001E42D006
 - F001E42D012
 - F001E42D018
 - F001E42D030
 - F001E42D033

2700K

- Non Dimmable
- F001E23A001
 - F001E23A006
 - F001E23A012
 - F001E23A018
 - F001E23A030
 - F001E23A033
- 1-10V
- F001E23B001
 - F001E23B006
 - F001E23B012
 - F001E23B018
 - F001E23B030
 - F001E23B033
- Dali
- F001E23D001
 - F001E23D006
 - F001E23D012
 - F001E23D018
 - F001E23D030
 - F001E23D033

3000K

- Non Dimmable
- F001E33A001
 - F001E33A006
 - F001E33A012
 - F001E33A018
 - F001E33A030
 - F001E33A033
- 1-10V
- F001E33B001
 - F001E33B006
 - F001E33B012
 - F001E33B018
 - F001E33B030
 - F001E33B033
- Dali
- F001E33D001
 - F001E33D006
 - F001E33D012
 - F001E33D018
 - F001E33D030
 - F001E33D033

4000K

- Non Dimmable
- F001E43A001
 - F001E43A006
 - F001E43A012
 - F001E43A018
 - F001E43A030
 - F001E43A033
- 1-10V
- F001E43B001
 - F001E43B006
 - F001E43B012
 - F001E43B018
 - F001E43B030
 - F001E43B033
- Dali
- F001E43D001
 - F001E43D006
 - F001E43D012
 - F001E43D018
 - F001E43D030
 - F001E43D033

Belvedere Spot Pick

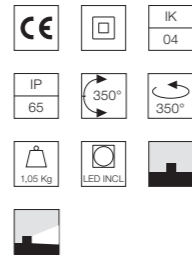
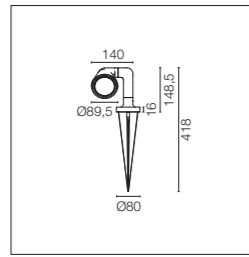

Alimentazione elettrica 220-240V inclusa. Include un sistema di giunzione IP68 H2O Stop anti-condensa a 2 vie 4 poli. Versione dimmerabile 24V disponibile su richiesta. Versione 110V a richiesta.

220-240V power supply included. Included 2 way terminal block 4 poles IP68 H2O Stop. 24V Dimmable version available on request. Version 110V upon request.

Power Led: 6W - 513 lm ≠ *FIXT 425 lm - 2700K/CRI 80 - 220-240V / 6W - 530 lm ≠ *FIXT 440 lm - 3000K/CRI 80 - 220-240V / 6W - 570 lm ≠ *FIXT 473 lm - 4000K/CRI 80 - 220-240V
*FIXT lm = Spot Optic

2700K

- Non Dimmable
- F001F21A001
 - F001F21A006
 - F001F21A012
 - F001F21A018
 - F001F21A030
 - F001F21A033

2700K

- Non Dimmable
- F001F22A001
 - F001F22A006
 - F001F22A012
 - F001F22A018
 - F001F22A030
 - F001F22A033

2700K

- Non Dimmable
- F001F23A001
 - F001F23A006
 - F001F23A012
 - F001F23A018
 - F001F23A030
 - F001F23A033

3000K

- Non Dimmable
- F001F31A001
 - F001F31A006
 - F001F31A012
 - F001F31A018
 - F001F31A030
 - F001F31A033

3000K

- Non Dimmable
- F001F32A001
 - F001F32A006
 - F001F32A012
 - F001F32A018
 - F001F32A030
 - F001F32A033

3000K

- Non Dimmable
- F001F33A001
 - F001F33A006
 - F001F33A012
 - F001F33A018
 - F001F33A030
 - F001F33A033

4000K

- Non Dimmable
- F001F41A001
 - F001F41A006
 - F001F41A012
 - F001F41A018
 - F001F41A030
 - F001F41A033

4000K

- Non Dimmable
- F001F42A001
 - F001F42A006
 - F001F42A012
 - F001F42A018
 - F001F42A030
 - F001F42A033

4000K

- Non Dimmable
- F001F43A001
 - F001F43A006
 - F001F43A012
 - F001F43A018
 - F001F43A030
 - F001F43A033

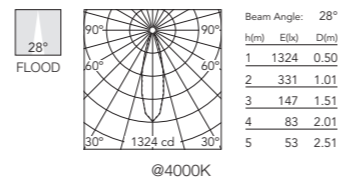
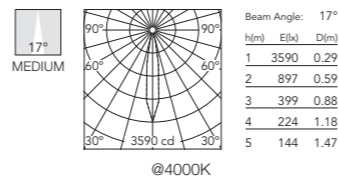
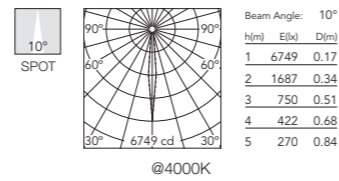

Belvedere Spot Wall

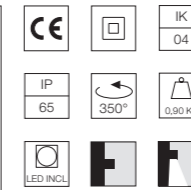
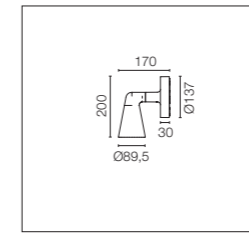

Attacco a parete. Alimentazione elettrica 220-240V inclusa. Include un sistema di giunzione IP68 H2O Stop anti-condensa a 2 vie 4 poli. Versione dimmerabile 24V disponibile su richiesta.

Direct wall installation. 220-240V power supply included. Included 2 way terminal block 4 poles IP68 H2O Stop. 24V Dimmable version available on request.

Power Led: 6W - 513 lm ≠ *FIXT 425 lm - 2700K/CRI 80 - 220-240V / 6W - 530 lm ≠ *FIXT 440 lm - 3000K/CRI 80 - 220-240V / 6W - 570 lm ≠ *FIXT 473 lm - 4000K/CRI 80 - 220-240V
*FIXT lm = Spot Optic

2700K

- Non Dimmable
- F001G21A001
 - F001G21A006
 - F001G21A012
 - F001G21A018
 - F001G21A030
 - F001G21A033

2700K

- Non Dimmable
- F001G22A001
 - F001G22A006
 - F001G22A012
 - F001G22A018
 - F001G22A030
 - F001G22A033

2700K

- Non Dimmable
- F001G23A001
 - F001G23A006
 - F001G23A012
 - F001G23A018
 - F001G23A030
 - F001G23A033

3000K

- Non Dimmable
- F001G31A001
 - F001G31A006
 - F001G31A012
 - F001G31A018
 - F001G31A030
 - F001G31A033

3000K

- Non Dimmable
- F001G32A001
 - F001G32A006
 - F001G32A012
 - F001G32A018
 - F001G32A030
 - F001G32A033

3000K

- Non Dimmable
- F001G33A001
 - F001G33A006
 - F001G33A012
 - F001G33A018
 - F001G33A030
 - F001G33A033

4000K

- Non Dimmable
- F001G41A001
 - F001G41A006
 - F001G41A012
 - F001G41A018
 - F001G41A030
 - F001G41A033

4000K

- Non Dimmable
- F001G42A001
 - F001G42A006
 - F001G42A012
 - F001G42A018
 - F001G42A030
 - F001G42A033

4000K

- Non Dimmable
- F001G43A001
 - F001G43A006
 - F001G43A012
 - F001G43A018
 - F001G43A030
 - F001G43A033

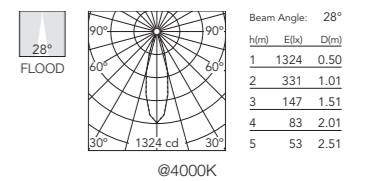
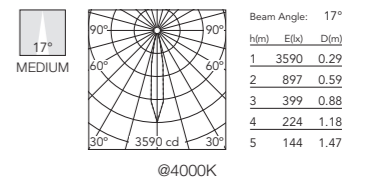
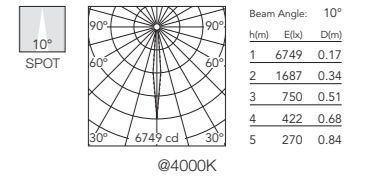

Belvedere Spot: Accessori / Accessories

Cassaforma per l'installazione a terra. Box for ground installation.

Belvedere Spot / Clove
F001Z020000

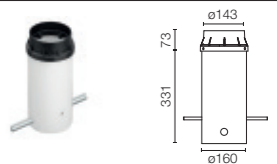

Visiera spot.

Spot visor.

Belvedere Spot
F001Z010000



Visiera spot con "honeycomb".

Spot visor with honeycomb.

Belvedere Spot
F001Z030000



Visiera spot con "flood".

Spot visor with flood lens.

Belvedere Spot
F001Z040000



Dispositivo di protezione per il sovraccarico. 275 Vac. Corrente massima di scarica 10KA (8/29us). Massima corrente operativa 5A. Adatto per la connessione in serie. IP66.

Surge protection device. 275Vac. Maximum discharge current 10KA (8/20us). Maximum operating current 5A. Suitable for series connection. IP66.

Belvedere Spot / Clove / Wall
F990E00A000

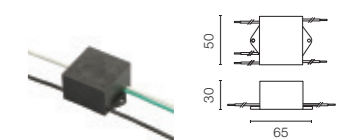

Klein Pro



Designed by Flos Outdoor



Famiglia / Family

Klein Pro



Power Led

11W
294 lm - 2700K/CRI 80
304 lm - 3000K/CRI 80
325 lm - 4000K/CRI 80

Colori / Colours

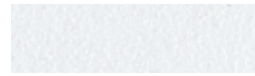

01 White



06 Grey



12 Forest Green

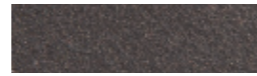

18 Deep Brown



30 Black



33 Anthracite



70 Anodized Natural



71 Anodized Black



73 Anodized Gold*

* Solo per schermo. / Only for pole screen.

Descrizione / Description

Il corpo del paletto Klein Pro è stato realizzato in alluminio estruso mentre la base e il diffusore sono in alluminio pressofuso EN AB-47100 con un basso tenore di rame.

Rivestimento ad alta resistenza: il trattamento esterno viene applicato con un doppio strato di polveri epossidiche conformemente alla norma QUALICOAT. Il primo strato di polvere fornisce una resistenza chimica e meccanica; un secondo strato di finitura di polvere di poliestere garantisce la resistenza.

È disponibile anche con finitura anodizzata.

The body of Klein Pro bollard is made of extruded aluminium, base and diffuser in die-cast aluminium EN AB-47100 with a low copper content.

High-resistance coating: the external coating is applied with a double layer with epoxy powders according to the QUALICOAT standard. The first layer of epoxy powder gives chemical and mechanical resistance, the second finishing layer of polyester powder ensures resistance.

Also available in anodized finishes.

Klein Pro 600

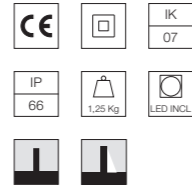
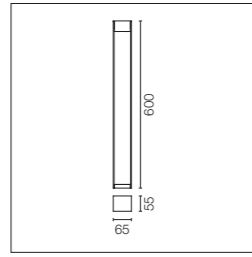

Alimentazione elettrica 220-240V integrata. Gli accessori per installazione su superficie solida o per fissaggio al terreno sono da ordinare a parte. Ogni apparecchio di illuminazione è dotato di un segmento di 1000 mm di cavo in uscita e un kit di cablaggio.

220-240V power supply integrated. Solid surface or ground installation accessories to be ordered separately. Each luminaire is equipped with 1000 mm length outgoing cable and a wiring kit.

Power Led: 11W - 1089 lm ≠ FIXT 294 lm - 2700K/CRI 80 - 220-240V / 11W - 1126 lm ≠ FIXT 304 lm - 3000K/CRI 80 - 220-240V / 11W - 1211 lm ≠ FIXT 325 lm - 4000K/CRI 80 - 220-240V

2700K

Non Dimmable

- F002A20A001.A
- F002A20A006.A
- F002A20A012.A
- F002A20A018.A
- F002A20A030.A
- F002A20A033.A
- F002A21A070.A
- F002A21A071.A

1-10V

- F002A20B001.A
- F002A20B006.A
- F002A20B012.A
- F002A20B018.A
- F002A20B030.A
- F002A20B033.A
- F002A21B070.A
- F002A21B071.A

Dali

- F002A20D001.A
- F002A20D006.A
- F002A20D012.A
- F002A20D018.A
- F002A20D030.A
- F002A20D033.A
- F002A21D070.A
- F002A21D071.A

3000K

Non Dimmable

- F002A30A001.A
- F002A30A006.A
- F002A30A012.A
- F002A30A018.A
- F002A30A030.A
- F002A30A033.A
- F002A31A070.A
- F002A31A071.A

1-10V

- F002A30B001.A
- F002A30B006.A
- F002A30B012.A
- F002A30B018.A
- F002A30B030.A
- F002A30B033.A
- F002A31B070.A
- F002A31B071.A

Dali

- F002A30D001.A
- F002A30D006.A
- F002A30D012.A
- F002A30D018.A
- F002A30D030.A
- F002A30D033.A
- F002A31D070.A
- F002A31D071.A

4000K

Non Dimmable

- F002A40A001.A
- F002A40A006.A
- F002A40A012.A
- F002A40A018.A
- F002A40A030.A
- F002A40A033.A
- F002A41A070.A
- F002A41A071.A

1-10V

- F002A40B001.A
- F002A40B006.A
- F002A40B012.A
- F002A40B018.A
- F002A40B030.A
- F002A40B033.A
- F002A41B070.A
- F002A41B071.A

Dali

- F002A40D001.A
- F002A40D006.A
- F002A40D012.A
- F002A40D018.A
- F002A40D030.A
- F002A40D033.A
- F002A41D070.A
- F002A41D071.A

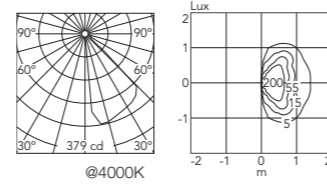

Klein Pro 900

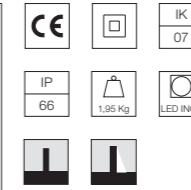
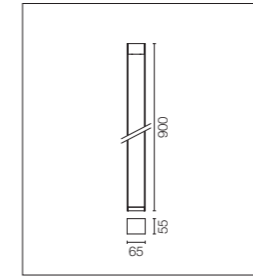

Alimentazione elettrica 220-240V integrata. Gli accessori per installazione su superficie solida o per fissaggio al terreno sono da ordinare a parte. Ogni apparecchio di illuminazione è dotato di un segmento di 1000 mm di cavo in uscita e un kit di cablaggio.

220-240V power supply integrated. Solid surface or ground installation accessories to be ordered separately. Each luminaire is equipped with 1000 mm length outgoing cable and a wiring kit.

Power Led: 11W - 1089 lm ≠ FIXT 294 lm - 2700K/CRI 80 - 220-240V / 11W - 1126 lm ≠ FIXT 304 lm - 3000K/CRI 80 - 220-240V / 11W - 1211 lm ≠ FIXT 325 lm - 4000K/CRI 80 - 220-240V

2700K

Non Dimmable

- F002B20A001.A
- F002B20A006.A
- F002B20A012.A
- F002B20A018.A
- F002B20A030.A
- F002B20A033.A
- F002B21A070.A
- F002B21A071.A

1-10V

- F002B20B001.A
- F002B20B006.A
- F002B20B012.A
- F002B20B018.A
- F002B20B030.A
- F002B20B033.A
- F002B21B070.A
- F002B21B071.A

Dali

- F002B20D001.A
- F002B20D006.A
- F002B20D012.A
- F002B20D018.A
- F002B20D030.A
- F002B20D033.A
- F002B21D070.A
- F002B21D071.A

3000K

Non Dimmable

- F002B30A001.A
- F002B30A006.A
- F002B30A012.A
- F002B30A018.A
- F002B30A030.A
- F002B30A033.A
- F002B31A070.A
- F002B31A071.A

1-10V

- F002B30B001.A
- F002B30B006.A
- F002B30B012.A
- F002B30B018.A
- F002B30B030.A
- F002B30B033.A
- F002B31B070.A
- F002B31B071.A

Dali

- F002B30D001.A
- F002B30D006.A
- F002B30D012.A
- F002B30D018.A
- F002B30D030.A
- F002B30D033.A
- F002B31D070.A
- F002B31D071.A

4000K

Non Dimmable

- F002B40A001.A
- F002B40A006.A
- F002B40A012.A
- F002B40A018.A
- F002B40A030.A
- F002B40A033.A
- F002B41A070.A
- F002B41A071.A

1-10V



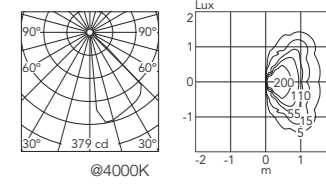

- F002B40B001.A
- F002B40B006.A
- F002B40B012.A
- F002B40B018.A
- F002B40B030.A
- F002B40B033.A
- F002B41B070.A
- F002B41B071.A

Dali

- F002B40D001.A
- F002B40D006.A
- F002B40D012.A
- F002B40D018.A
- F002B40D030.A
- F002B40D033.A
- F002B41D070.A
- F002B41D071.A

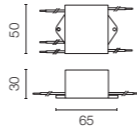

Klein Pro: Accessori / Accessories

Base di fissaggio per superfici solide.	Fixing base for solid surfaces.	<ul style="list-style-type: none"> ○ F002Z010001.A ● F002Z010006.A ● F002Z010012.A ● F002Z010018.A ● F002Z010030.A ● F002Z010033.A 	
Piastra di fissaggio a terra Minimal Klein Pro, 47x57xH160 mm.	Minimal Klein Pro ground fixation plate, 47x57xH160 mm.	F002Z030000.A	
Piastra di fissaggio a terra e tirafondi Klein Pro 85x85xH160mm.	Klein Pro base plate and fixing bolts 85x85xH160mm.	F002Z020000	
Schermo estetico anodizzato.	Anodized aestetical pole screen.	<ul style="list-style-type: none"> H 600 mm ● F002Z040070.A ● F002Z040071.A ● F002Z040073.A H 900 mm ● F002Z050070.A ● F002Z050071.A ● F002Z050073.A 	
Dispositivo di protezione per il sovraccarico. 240 Vac. Corrente massima di scarica 10KA (8/29us). Massima corrente operativa 5A. Adatto per la connessione in serie. IP66.	Surge protection device. 275Vac. Maximum discharge current 10KA (8/20us). Maximum operating current 5A. Suitable for series connection. IP66.	F990E00A000	 

Opzioni Montaggio / Installation Options

Option 1
Con tirafondi /
Fixing anchor bolts

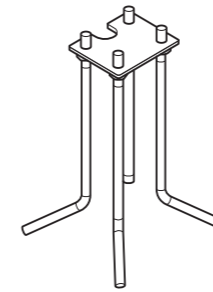
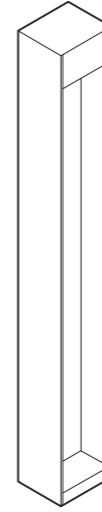

cod. F002Z030000.A

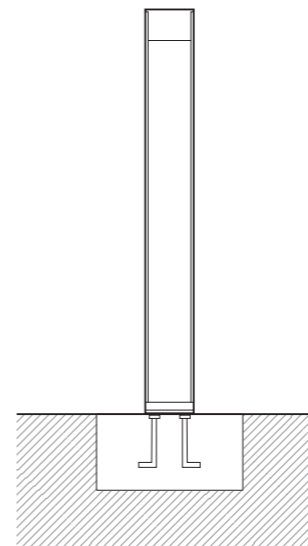

Option 2
Con base e tirafondi /
With base and fixing anchor bolts

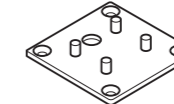
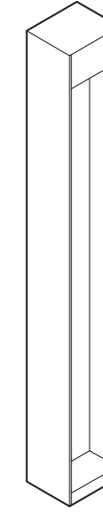

cod. F002Z0100.A

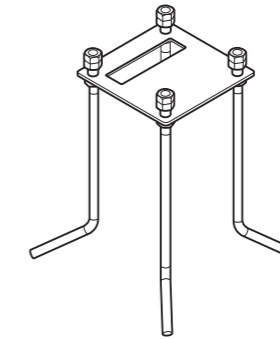

cod. F002Z020000

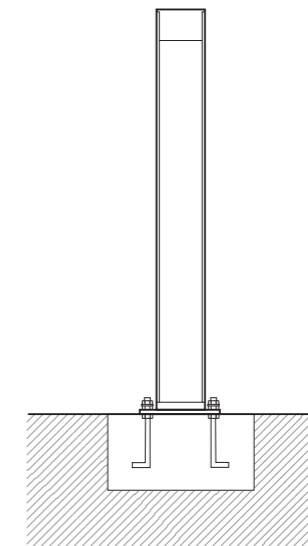

Option 3
Base per fissaggio con tasselli (non inclusi) /
With base for bolts (not included)

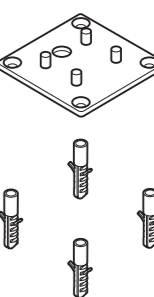
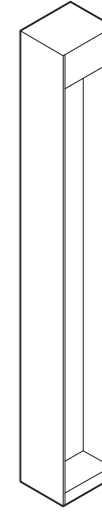

cod. F002Z0100.A

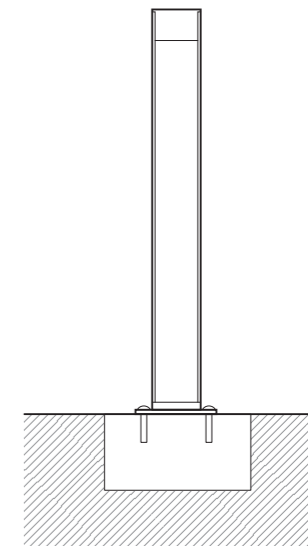

Zefiro



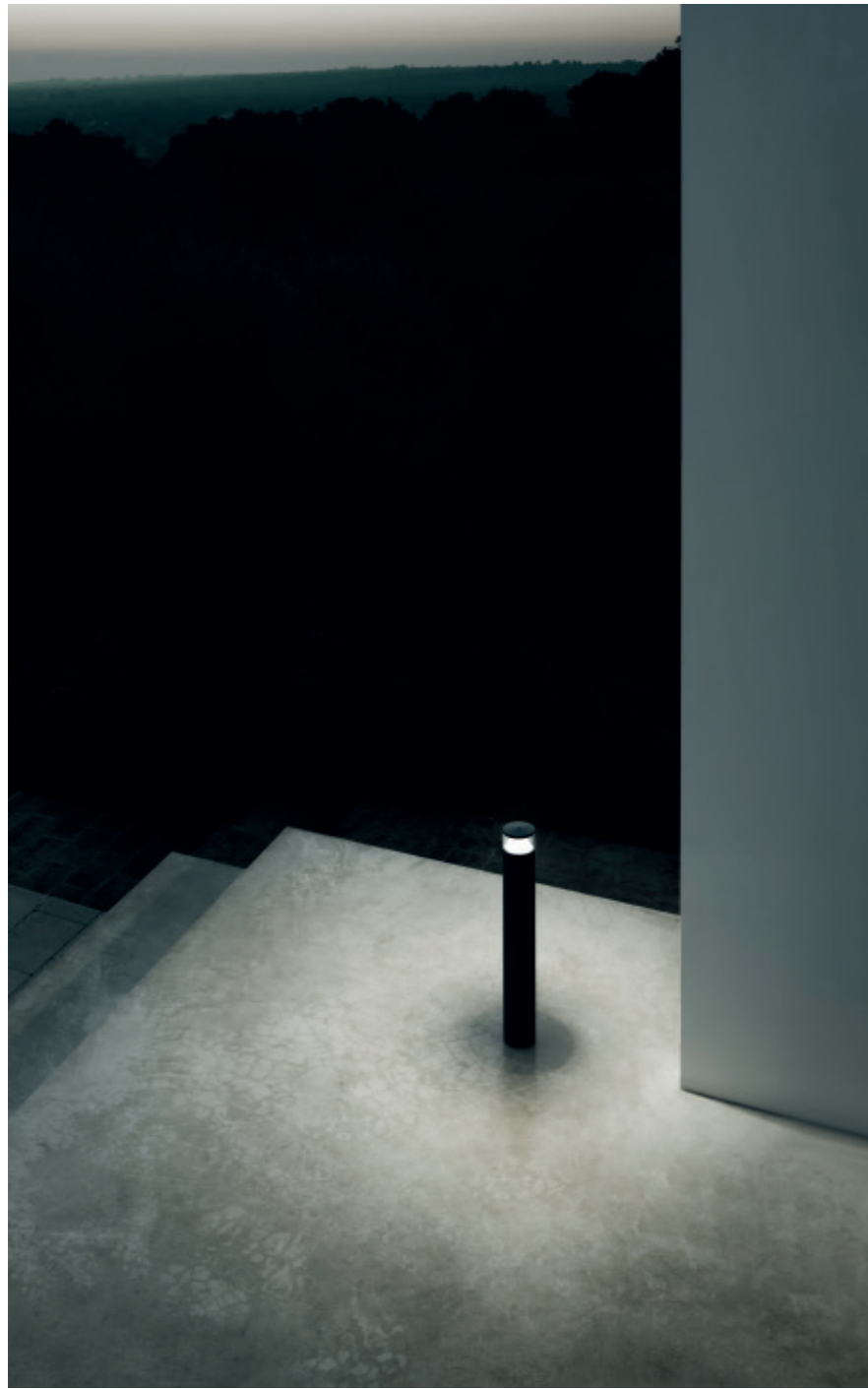

Zefiro



Famiglia / Family

Zefiro



Mid - Power Led

up to 14,5W

up to 1357 lm - 2700K/CRI 80

up to 1423 lm - 3000K/CRI 80

up to 1494 lm - 4000K/CRI 80

* Net lumen output

Descrizione / Description

Bollard per esterno con sorgente luminosa a LED, disponibili in tre altezze. Struttura cilindrica del palo in alluminio estruso, testa dell'apparecchio in fusione di alluminio, diffusore in policarbonato trasparente e stabilizzato ai raggi UV.

La sorgente luminosa integrata nella testa permette una emissione luminosa asimmetrica radiale direzionata verso il basso che combinata con il riflettore conico in alluminio verniciato permette il contenimento delle riflessioni dirette verso l'alto.

L'apparecchio è disponibile in differenti finiture con rivestimento a doppio strato di polveri e sottoposte a trattamento di conversione chimica superficiale per una elevata resistenza alla corrosione.

L'apparecchio può essere installato facilmente a terra su qualsiasi pavimento con tasselli, oppure utilizzando l'accessorio dedicato piastra di ancoraggio e tirafondi per rendere la base del prodotto totalmente solidale con la pavimentazione. Le viterie di fissaggio sono in acciaio inox AISI 316L.

Outdoor bollard with LED light source. Available in three heights. Cylindrical, extruded aluminium body, die-cast aluminium cap, polycarbonate, transparent and UV-stabilized diffuser. The light source integrated in the cap allows a radial and asymmetrical light emission oriented towards the base, which can be combined to the painted aluminium, conical reflector to contain the direct reflection upwards. Available in different finishes with a double layer coating and a chemical conversion surface treatment to guarantee high resistance to corrosion. The bollard can be easily installed on any kind of ground surface, directly with studs or through the dedicated fixing plate and bolts which solidly attach the luminaire to the ground. The fixing screws are made of AISI 316L stainless steel.

Colori / Colours



01 White



06 Grey



12 Forest Green

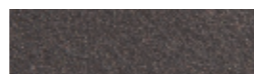

18 Deep Brown



30 Black



33 Anthracite

Zefiro 200

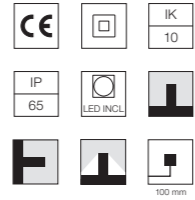
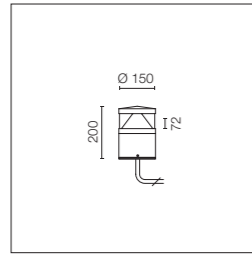

Sorgente a LED inclusa.
Alimentazione elettrica 220-240V ON/ OFF e dimmerabile 1-10V o DALI integrata. Dotato di spezzone di cavo uscente in neoprene di 1m e di sistema di giunzione IP68 H2O Stop a 2 vie. Installabile su qualsiasi pavimento per mezzo di tasselli. Piastra di ancoraggio per l'installazione in gettata da ordinare separatamente.

LED source included. Integrated electric power supply 220-240V ON/ OFF and adjustable light intensity from 1 to 10V or DALI. Equipped with a protruding, neoprene, one meter cable and a 2-way IP68 H2O connection system. It can be installed on any ground using studs or a recessed fixing plate with mortar, to be ordered separately.

Power Led: 14,5W - LED 1716 lm ≠ OUTPUT 1357 lm - 2700K/CRI 80 - 220÷240V / 14,5W - LED 1845 lm ≠ OUTPUT 1423 lm - 3000K/CRI 80 - 220÷240V / 14,5W - LED 1937 lm ≠ OUTPUT 1494 lm - 4000K/CRI 80 - 220÷240V

2700K

- Non Dimmable
- FA53201401
 - FA53201406
 - FA53201412
 - FA53201418
 - FA53201430
 - FA53201433
- 1-10V
- FA53201401-310
 - FA53201406-310
 - FA53201412-310
 - FA53201418-310
 - FA53201430-310
 - FA53201433-310
- Dali
- FA53201401-300
 - FA53201406-300
 - FA53201412-300
 - FA53201418-300
 - FA53201430-300
 - FA53201433-300

3000K

- Non Dimmable
- FA53200301
 - FA53200306
 - FA53200312
 - FA53200318
 - FA53200330
 - FA53200333
- 1-10V
- FA53200301-310
 - FA53200306-310
 - FA53200312-310
 - FA53200318-310
 - FA53200330-310
 - FA53200333-310
- Dali
- FA53200301-300
 - FA53200306-300
 - FA53200312-300
 - FA53200318-300
 - FA53200330-300
 - FA53200333-300

4000K

- Non Dimmable
- FA53200201
 - FA53200206
 - FA53200212
 - FA53200218
 - FA53200230
 - FA53200233
- 1-10V
- FA53200201-310
 - FA53200206-310
 - FA53200212-310
 - FA53200218-310
 - FA53200230-310
 - FA53200233-310
- Dali
- FA53200201-300
 - FA53200206-300
 - FA53200212-300
 - FA53200218-300
 - FA53200230-300
 - FA53200233-300

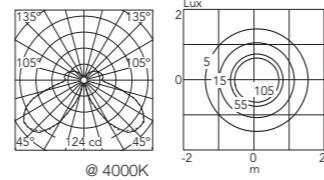

Zefiro 1000

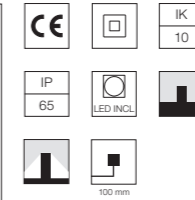
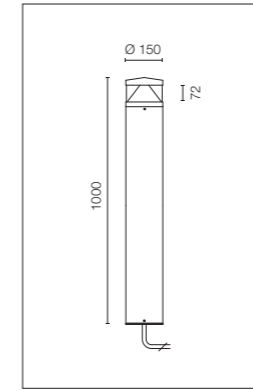

Sorgente a LED inclusa.
Alimentazione elettrica 220-240V ON/ OFF e dimmerabile 1-10V o DALI integrata. Dotato di spezzone di cavo uscente in neoprene di 1m e di sistema di giunzione IP68 H2O Stop a 2 vie. Installabile su qualsiasi pavimento per mezzo di tasselli. Piastra di ancoraggio per l'installazione in gettata da ordinare separatamente.
Versione Mid-night a richiesta.

LED source included. Integrated electric power supply 220-240V ON/ OFF and adjustable light intensity from 1 to 10V or DALI. Equipped with a protruding, neoprene, one meter cable and a 2-way IP68 H2O connection system. It can be installed on any ground using studs or a recessed fixing plate with mortar, to be ordered separately.
Mid-Night version available upon request.

Power Led: 14,5W - LED 1716 lm ≠ OUTPUT 1357 lm - 2700K/CRI 80 - 220÷240V / 14,5W - LED 1845 lm ≠ OUTPUT 1423 lm - 2700K/CRI 80 - 220÷240V / 14,5W - LED 1937 lm ≠ OUTPUT 1494 lm - 4000K/CRI 80 - 220÷240V

2700K

- Non Dimmable
- FA53202001
 - FA53202006
 - FA53202012
 - FA53202018
 - FA53202030
 - FA53202033
- 1-10V
- FA53202001-310
 - FA53202006-310
 - FA53202012-310
 - FA53202018-310
 - FA53202030-310
 - FA53202033-310
- Dali
- FA53202001-300
 - FA53202006-300
 - FA53202012-300
 - FA53202018-300
 - FA53202030-300
 - FA53202033-300

3000K

- Non Dimmable
- FA53200901
 - FA53200906
 - FA53200912
 - FA53200918
 - FA53200930
 - FA53200933
- 1-10V
- FA53200901-310
 - FA53200906-310
 - FA53200912-310
 - FA53200918-310
 - FA53200930-310
 - FA53200933-310
- Dali
- FA53200901-300
 - FA53200906-300
 - FA53200912-300
 - FA53200918-300
 - FA53200930-300
 - FA53200933-300

4000K

- Non Dimmable
- FA53200801
 - FA53200806
 - FA53200812
 - FA53200818
 - FA53200830
 - FA53200833
- 1-10V
- FA53200801-310
 - FA53200806-310
 - FA53200812-310
 - FA53200818-310
 - FA53200830-310
 - FA53200833-310
- Dali
- FA53200801-300
 - FA53200806-300
 - FA53200812-300
 - FA53200818-300
 - FA53200830-300
 - FA53200833-300

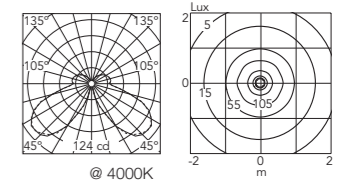

Zefiro 600

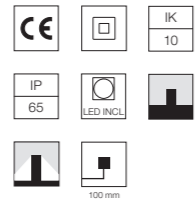
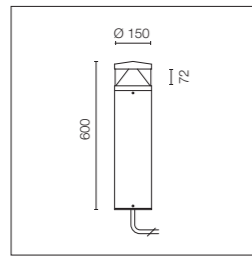

Sorgente a LED inclusa.
Alimentazione elettrica 220-240V ON/ OFF e dimmerabile 1-10V o DALI integrata. Dotato di spezzone di cavo uscente in neoprene di 1m e di sistema di giunzione IP68 H2O Stop a 2 vie. Installabile su qualsiasi pavimento per mezzo di tasselli. Piastra di ancoraggio per l'installazione in gettata da ordinare separatamente.
Versione Mid-night a richiesta.

LED source included. Integrated electric power supply 220-240V ON/OFF and adjustable light intensity from 1 to 10V or DALI. Equipped with a protruding, neoprene, one meter cable and a 2-way IP68 H2O connection system. It can be installed on any ground using studs or a recessed fixing plate with mortar, to be ordered separately.
Mid-Night version available upon request.

Power Led: 14,5W - LED 1716 lm ≠ OUTPUT 1357 lm - 2700K/CRI 80 - 220÷240V / 14,5W - LED 1845 lm ≠ OUTPUT 1423 lm - 2700K/CRI 80 - 220÷240V / 14,5W - LED 1937 lm ≠ OUTPUT 1494 lm - 4000K/CRI 80 - 220÷240V

2700K

- Non Dimmable
- FA53201701
 - FA53201706
 - FA53201712
 - FA53201718
 - FA53201730
 - FA53201733
- 1-10V
- FA53201701-310
 - FA53201706-310
 - FA53201712-310
 - FA53201718-310
 - FA53201730-310
 - FA53201733-310
- Dali
- FA53201701-300
 - FA53201706-300
 - FA53201712-300
 - FA53201718-300
 - FA53201730-300
 - FA53201733-300

3000K





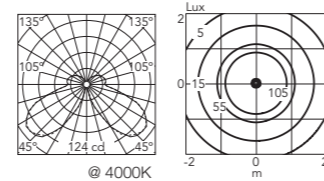

- Non Dimmable
- FA53200601
 - FA53200606
 - FA53200612
 - FA53200618
 - FA53200630
 - FA53200633
- 1-10V
- FA53200601-310
 - FA53200606-310
 - FA53200612-310
 - FA53200618-310
 - FA53200630-310
 - FA53200633-310
- Dali
- FA53200601-300
 - FA53200606-300
 - FA53200612-300
 - FA53200618-300
 - FA53200630-300
 - FA53200633-300

4000K

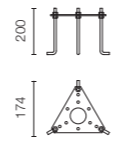
- Non Dimmable
- FA53200501
 - FA53200506
 - FA53200512
 - FA53200518
 - FA53200530
 - FA53200533
- 1-10V
- FA53200501-310
 - FA53200506-310
 - FA53200512-310
 - FA53200518-310
 - FA53200530-310
 - FA53200533-310
- Dali
- FA53200501-300
 - FA53200506-300
 - FA53200512-300
 - FA53200518-300
 - FA53200530-300
 - FA53200533-300

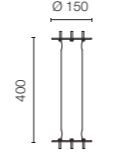

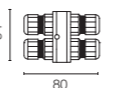
Zefiro: Accessori / Accessories

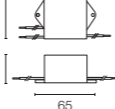
Piastra tirafondi.	Base plate with bolt.	FA21		
Base di fissaggio a terra ad alta resistenza.	High resistance in-ground box for installation	FA185		
Sistema di giunzione IP68 H ₂ O Stop anti-condensa a 3/4 vie 4 poli. (ø5,5÷12mm cavo).	3/4 way terminal block 4 poles IP68 H ₂ O Stop. (ø5,5÷12mm cable).	F990C010000		
Dispositivo di protezione per il sovraccarico. 275Vac. Corrente massima di scarica 10KA (8/29µs). Massima corrente operativa 5A. Adatto per la connessione in serie. IP66.	Surge protection device. 275Vac. Maximum discharge current 10KA (8/20µs). Maximum operating current 5A. Suitable for series connection. IP66.	F990E00A000		

Metodo di fissaggio corretto

Paletto fissato su un plinto in cemento + viti di fissaggio idonee.

Correct Fixing Method

Bollard fixed on plinth + plug.

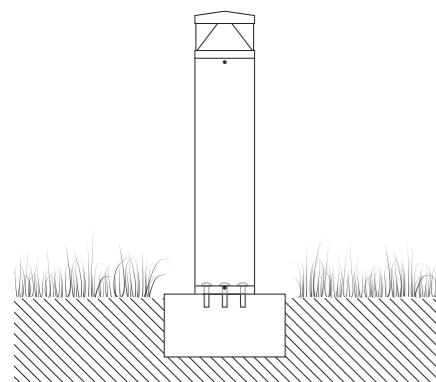

Metodo di fissaggio corretto

Paletto fissato su un piccolo in cemento + piastra di ancoraggio e tirafondi.

Correct Fixing Method

Bollard fixed on plinth + fixing bolts.

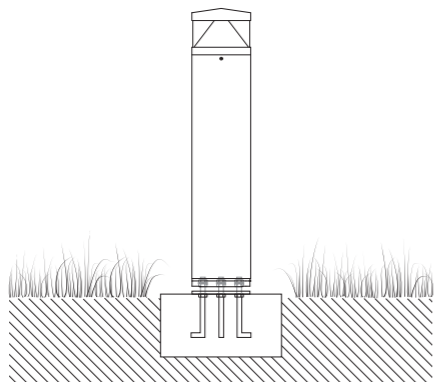

Metodo di fissaggio non corretto

Non fissare il paletto direttamente sul terreno.

Incorrect Fixing Method

Do not fix the bollard directly on the ground.

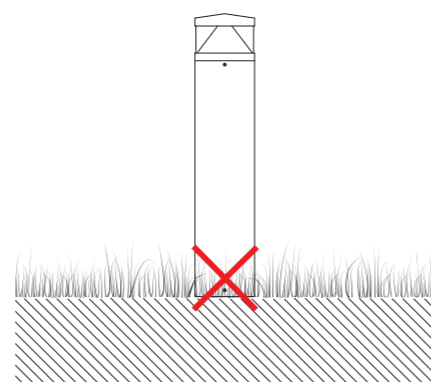

I-Ron





Famiglia / Family

I-Ron



Power Led

up to 11W
up to 391 lm - 2700K/CRI 80
up to 420 lm - 3000K/CRI 80
up to 448 lm - 4000K/CRI 80

Descrizione / Description

Bollard per esterno con struttura composta da una trave IPE con profilo ad H in acciaio zincato ad immersione a caldo ad alta resistenza alla corrosione. Grazie al particolare design, l'apparecchio è utilizzabile anche come dissuasore architettonico fisso. La sorgente luminosa a LED in posizione arretrata è protetta da un diffusore posizionato nella parte superiore della barra, composto da un contenitore di materiale plastico con copertura zincata. Le componenti elettriche sono alloggiato nel retro dell'apparecchio. L'apparecchio può essere installato facilmente a terra su qualsiasi pavimento con tasselli, oppure utilizzando l'accessorio dedicato piastra di ancoraggio e tirafondi per rendere la base del prodotto totalmente solidale con la pavimentazione. Le viterie di fissaggio sono in acciaio inox AISI 316L.

Outdoor bollard with hot-dip zinc-coated IPE steel bar H-frame structure for high resistance to corrosion. Thanks to its unique design, the fixture can also be used as a fixed architectural bollard. The LED light source is located at the back of the fixture and is protected by a plastic diffuser covered by zinc, which is located on the upper part of the bar. The electric components are located at the back of the luminaire. The bollard can be easily installed on any kind of ground surface, directly with studs or through the dedicated fixing plate and bolts which solidly attach the luminaire to the ground. The fixing screws are made of AISI 316L stainless steel.

Colori / Colours



90 Zinc

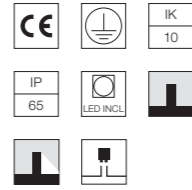
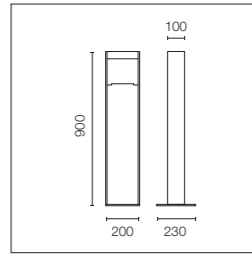

Sorgente luminosa a LED inclusa. Alimentazione elettrica 220-240V ON/ OFF integrata. Dotato di due pressacavi per cavi 8mm< ϕ <13mm per connessione entra-esce. Installabile su qualsiasi pavimento per mezzo di tasselli. Piastra di ancoraggio per l'installazione in gettata da ordinare separatamente.

LED source included. Integrated electric power supply 220-240V ON/OFF. Equipped with two rubber cable guides (8< ϕ <13mm cables) for inlet-outlet connections. It can be installed on any ground using studs or a recessed fixing plate with mortar, to be ordered separately.

Power Led: 11W - LED 1011 lm \neq OUTPUT 391 lm - 2700K/CRI 80 - 220-240V / 11W - LED 1087 lm \neq OUTPUT 420 lm - 3000K/CRI 80 - 220-240V / 11W - LED 1162 lm \neq OUTPUT 448 lm - 4000K/CRI 80 - 220-240V

- 2700K**
● FA1041060090
- 3000K**
● FA1041040090
- 4000K**
● FA1041970090

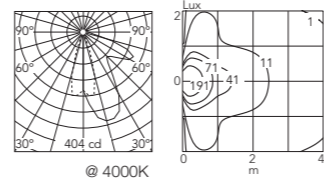

Piastra tirafondi.

Base plate with bolt.

FA109

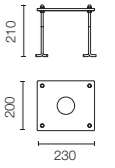

Dispositivo di protezione per il sovraccarico. 275 Vac. Corrente massima di scarica 10KA (8/29us). Massima corrente operativa 5A. Adatto per la connessione in serie. IP66.

Surge protection device. 275Vac. Maximum discharge current 10KA (8/20us). Maximum operating current 5A. Suitable for series connection. IP66.

F990E00A000

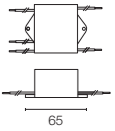

Metodo di fissaggio corretto

Paletto fissato su un plinto in cemento + viti di fissaggio idonee.

Correct Fixing Method

Bollard fixed on plinth + plug.

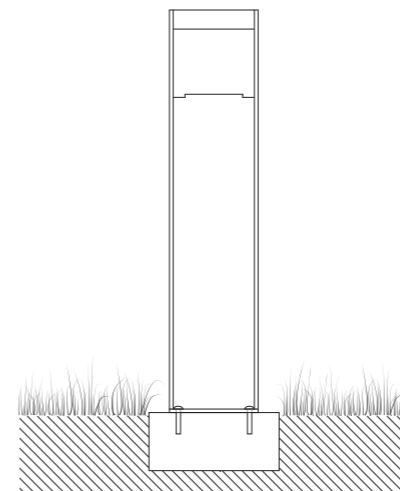

Metodo di fissaggio corretto

Paletto fissato su un piccolo in cemento + piastra di ancoraggio e tirafondi.

Correct Fixing Method

Bollard fixed on plinth + fixing bolts.

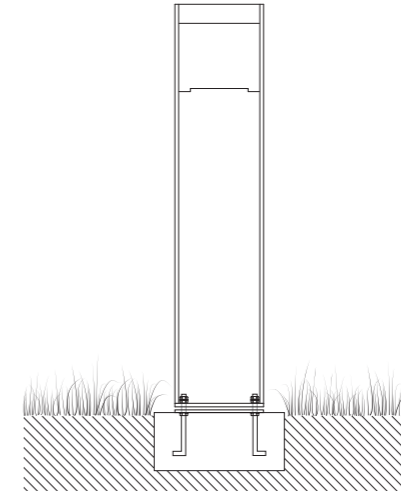

Metodo di fissaggio non corretto

Non fissare il paletto direttamente sul terreno.

Incorrect Fixing Method

Do not fix the bollard directly on the ground.

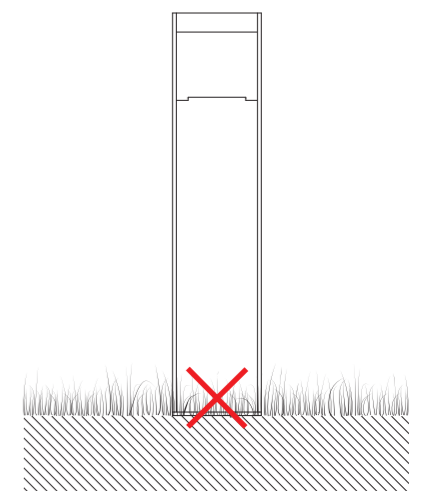

Talia





Famiglia / Family

Talia 360

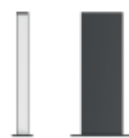

Low - Power Led

up to 4W
up to 73 lm - 2700K/CRI 80
up to 73 lm - 3000K/CRI 80
up to 73 lm - 4000K/CRI 80

* Net lumen output

Low - Power Led

up to 7W
up to 2x73 lm - 2700K/CRI 80
up to 2x73 lm - 3000K/CRI 80
up to 2x73 lm - 4000K/CRI 80

* Net lumen output

Talia 560



Low - Power Led

up to 6W
up to 123 lm - 2700K/CRI 80
up to 123 lm - 3000K/CRI 80
up to 123 lm - 4000K/CRI 80

* Net lumen output

Low - Power Led

up to 11W
up to 2x123 lm - 2700K/CRI 80
up to 2x123 lm - 3000K/CRI 80
up to 2x123 lm - 4000K/CRI 80

* Net lumen output

Descrizione / Description

Bollard per esterno equipaggiato con sorgente luminosa a LED. Disponibile in due altezze, declinate con emissione luminosa monodirezionale o bidirezionale. Struttura in alluminio estruso, testa dell'apparecchio in fusione di alluminio, diffusore in policarbonato opale e stabilizzato ai raggi UV. Il modulo led lineare è alloggiato in un cilindro di protezione sigillato in policarbonato trasparente con valvola di compensazione. Disponibile in differenti finiture con rivestimento a doppio strato di polveri e sottoposte a trattamento di conversione chimica superficiale per una elevata resistenza alla corrosione. L'apparecchio può essere installato facilmente a terra su qualsiasi pavimento con tasselli, oppure utilizzando l'accessorio dedicato piastra di ancoraggio e tirafondi per rendere la base del prodotto totalmente solidale con la pavimentazione. Le viterie di fissaggio del paletto sono in acciaio inox AISI 316L.

Outdoor bollard with LED light source. Available in two heights and monodirectional or bidirectional light emission. Extruded aluminium body. Die-cast aluminium cap. UV-stabilized, opal polycarbonate diffuser. The linear LED module is housed in a sealed transparent polycarbonate cylinder with compensation valve. Available in different finishes with a double layer coating and a chemical conversion surface treatment to guarantee high resistance to corrosion. The bollard can be easily installed on any kind of ground surface, directly with studs or through the dedicated fixing plate and bolts which solidly attach the luminaire to the ground. The fixing screws are made of AISI 316L stainless steel.

Colori / Colours



01 White



06 Grey



12 Forest Green

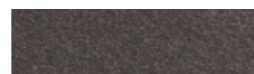

18 Deep Brown



30 Black

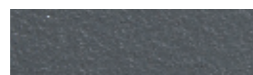

33 Anthracite

Talia 360

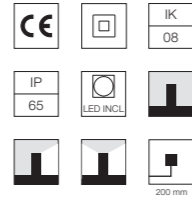
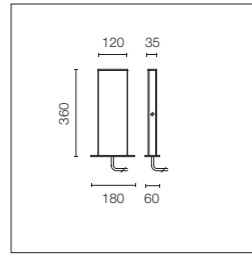

Sorgente luminosa a LED inclusa. Alimentazione elettrica 220-240V ON/ OFF integrata. Dotato di spezzone di cavo uscente in neoprene di circa 200 mm e kit con connettori crimp e guaina termorestringente adesiva per connessione a tenuta stagna. Installabile su qualsiasi pavimento per mezzo di tasselli.
Piastra di ancoraggio per l'installazione in gettata da ordinare separatamente.

LED source included. Integrated electric power supply 220-240V ON/OFF. The luminaire is equipped with a protruding, neoprene, two meter cable and a wiring kit with crimp connectors and adhesive heat-shrink tubing guaranteeing the water tightness of the connection.
It can be installed on any ground using studs or a recessed fixing plate with mortar, to be ordered separately.

Single Emission

Power Led: 4W - LED 216 lm ≠ OUTPUT 73 lm - 2700K/CRI 80 - 220÷240V / 4W - LED 216 lm ≠ OUTPUT 73 lm - 3000K / CRI 80 - 220÷240V / 4W - LED 216 lm ≠ OUTPUT 73 lm - 4000K/CRI 80 - 220÷240V

2700K

- FA50320601
- FA50320606
- FA50320612
- FA50320618
- FA50320630
- FA50320633

3000K

- FA50300601
- FA50300606
- FA50300612
- FA50300618
- FA50300630
- FA50300633

4000K

- FA50301101
- FA50301106
- FA50301112
- FA50301118
- FA50301130
- FA50301133

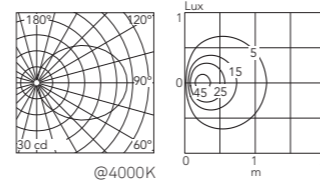

Double Emission

Power Led: 7W - LED 2x216 lm ≠ OUTPUT 2x73 lm - 2700K/CRI 80 - 220÷240V / 7W - LED 2x216 lm ≠ OUTPUT 2x73 lm - 4000K/CRI 80 - 220÷240V / 7W - LED 2x216 lm ≠ OUTPUT 2x73 lm - 4000K/CRI 80 - 220÷240V

2700K

- FA50320801
- FA50320806
- FA50320812
- FA50320818
- FA50320830
- FA50320833

3000K

- FA50300801
- FA50300806
- FA50300812
- FA50300818
- FA50300830
- FA50300833

4000K

- FA50301201
- FA50301206
- FA50301212
- FA50301218
- FA50301230
- FA50301233

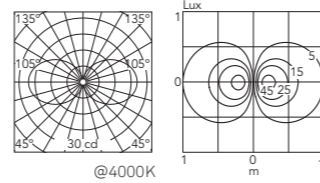

Talia 560

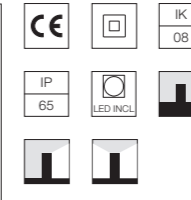
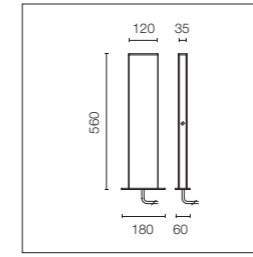

Sorgente luminosa a LED inclusa. Alimentazione elettrica 220-240V ON/ OFF integrata. Dotato di spezzone di cavo uscente in neoprene di circa 200 mm e kit con connettori crimp e guaina termorestringente adesiva per connessione a tenuta stagna. Installabile su qualsiasi pavimento per mezzo di tasselli.
Piastra di ancoraggio per l'installazione in gettata da ordinare separatamente.

LED source included. Integrated electric power supply 220-240V ON/OFF. The luminaire is equipped with a protruding, neoprene, two meter cable and a wiring kit with crimp connectors and adhesive heat-shrink tubing guaranteeing the water tightness of the connection.
It can be installed on any ground using studs or a recessed fixing plate with mortar, to be ordered separately.

Single Emission

Power Led: 6W - LED 360 lm ≠ OUTPUT 123 lm - 2700K/CRI 80 - 220÷240V / 6W - LED 360 lm ≠ OUTPUT 123 lm - 3000K/CRI 80 - 220÷240V / 6W - LED 360 lm ≠ OUTPUT 123 lm - 4000K/CRI 80 - 220÷240V

2700K

- FA50320201
- FA50320206
- FA50320212
- FA50320218
- FA50320230
- FA50320233

3000K

- FA50300201
- FA50300206
- FA50300212
- FA50300218
- FA50300230
- FA50300233

4000K

- FA50300901
- FA50300906
- FA50300912
- FA50300918
- FA50300930
- FA50300933

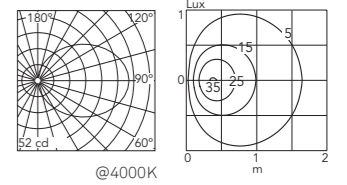

Double Emission

Power Led: 11W - LED 2x360 lm ≠ OUTPUT 2x123 lm - 2700K/CRI 80 - 220÷240V / 11W - LED 2x360 lm ≠ OUTPUT 2x123 lm - 3000K/CRI 80 - 220÷240V / 11W - LED 2x360 lm ≠ OUTPUT 2x123 lm - 4000K/CRI 80 - 220÷240V

2700K

- FA50320401
- FA50320406
- FA50320412
- FA50320418
- FA50320430
- FA50320433

3000K

- FA50300401
- FA50300406
- FA50300412
- FA50300418
- FA50300430
- FA50300433

4000K

- FA50301001
- FA50301006
- FA50301012
- FA50301018
- FA50301030
- FA50301033

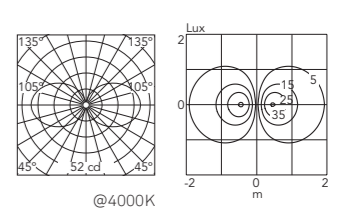

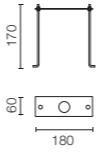
Piastra tirafondi.	Base plate with bolt.	FA139		
--------------------	-----------------------	-------	--	---

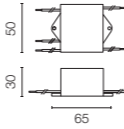
Dispositivo di protezione per il sovraccarico. 275Vac. Corrente massima di scarica 10KA (8/29µs). Massima corrente operativa 5A. Adatto per la connessione in serie. IP66.	Surge protection device. 275Vac. Maximum discharge current 10KA (8/20µs). Maximum operating current 5A. Suitable for series connection. IP66.	F990E00A000		
--	---	-------------	--	---

Metodo di fissaggio corretto

Paletto fissato su un plinto in cemento + viti di fissaggio idonee.

Correct Fixing Method

Bollard fixed on plinth + plug.

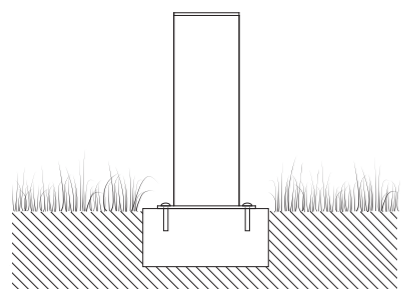

Metodo di fissaggio corretto

Paletto fissato su un piccolo in cemento + piastra di ancoraggio e tirafondi.

Correct Fixing Method

Bollard fixed on plinth + fixing bolts.

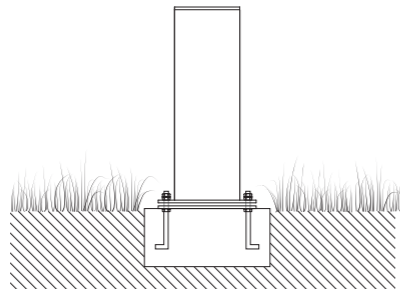

Metodo di fissaggio non corretto

Non fissare il paletto direttamente sul terreno.

Incorrect Fixing Method

Do not fix the bollard directly on the ground.

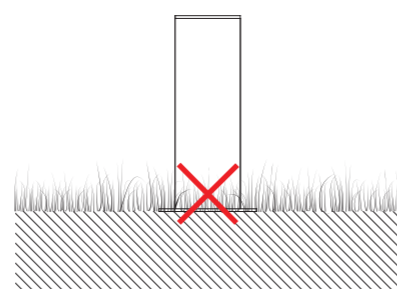

45



Designed by Tim Derhaag



Famiglia / Family

45



Power Led

9W
540 lm - 3000K/CRI 80

Descrizione / Description

Famiglia di apparecchi di illuminazione da esterno con testa orientabile in tre posizioni, 0°, 45° e 90°.

Sorgente luminosa power LED.

Corpo, testa e fondello in lega di alluminio 6010 anti-corodal estrusa con protezione fosfocromata anticorrosione.

Riflettori in alluminio 46100 pressofuso con finitura superficiale ottenuta mediante procedimento di alluminizzazione sotto vuoto.

Diffusori disponibili in bianco opaco o finitura trasparente per rispondere ad esigenze di elevata efficienza.

I materiali plastici utilizzati (PC o APEC) sono stampati ad iniezione e stabilizzati UV.

Il giunto meccanico è dotato di due flangie in lega di alluminio 46100 pressofuse con protezione anticorrosione in alodina gialla, due elementi a frizione rispettivamente in resina acetale stampata ad iniezione (POM) e lana di vetro 30% nylon.

Accessori in elastomeri di silicone. Le viti esterne esposte ad eventi meteorologici sono realizzate in acciaio inossidabile (AISI 316). Gli accessori includono schermi antiabbagliamento in Zamak 12 pressofuso con protezione anticorrosione in alodina gialla e finitura in polvere epossidica di colore nero opaco, i quali modificano l'angolo di uscita del raggio di luce per non arrecare disturbo alla vista.

È possibile bloccare la testa di ciascun apparecchio nella posizione scelta.

Family of outdoor luminaires with adjustable head in three positions, 0°, 45° and 90°. LED power light source power. Body, head and base are extruded anticorodal 6010 aluminum alloy with phospho-chromated protection against corrosion. Reflectors in die-cast 46100 aluminum with a surface finish obtained by means of a vacuum aluminization process.

The diffusers are available in opal white or in transparent finish whenever high efficiency is required.

The plastic materials used (PC or APEC) are injection-molded and UV-stabilized.

The mechanical joint has two die-cast 46100 aluminum alloy flanges with yellow alodine non-corrosive protection, two friction elements made respectively of injection-molded acetal resin (POM) and 30% nylon glass wool.

Silicone elastomer fittings. The external screws, which are exposed to weather conditions, are in stainless steel (AISI 316). Accessories include anti-glare screens in diecast Zamak 12 with non-corrosive yellow alodine protection and matte black epoxy powdercoat finish, which modify the angle at which the beam of light leaves the luminaire for enhanced visual comfort.

The head of each luminaire can be locked at the chosen position.

Colori / Colours



30 Black



54 Anodized Aluminium

45 Adj Led 1

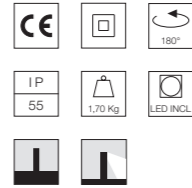
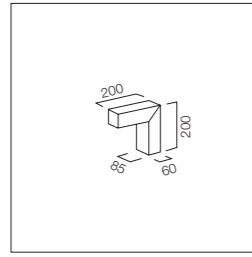

Completare con diffusori obbligatori.

To be completed with the required diffusers.

Power Led: 9W - 540 lm - 3000K/CRI 80

- F0070030
- F0070054

540 lm = FIXT 207 lm

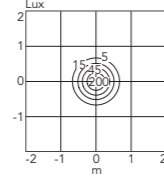
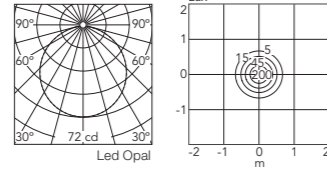

540 lm = FIXT 404 lm

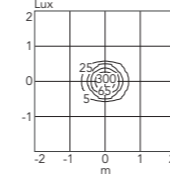
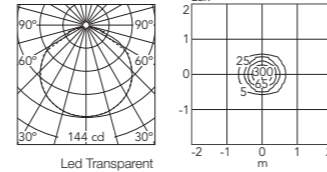

540 lm = FIXT 64 lm

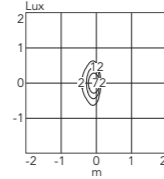
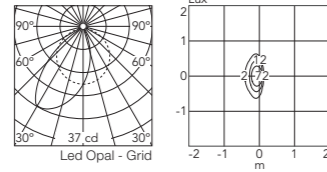

540 lm = FIXT 125 lm

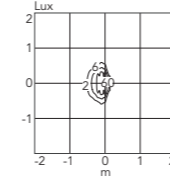
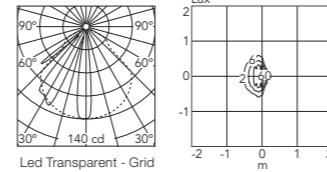

45 Adj Led 2

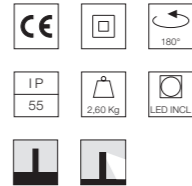
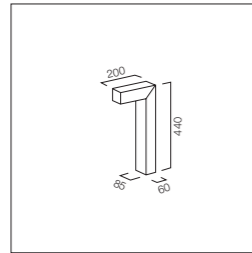

Completare con diffusori obbligatori.

To be completed with the required diffusers.

Power Led: 9W - 540 lm - 3000K/CRI 80

- F0071030
- F0071054

540 lm = FIXT 207 lm

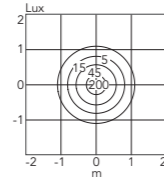
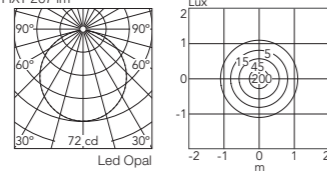

540 lm = FIXT 404 lm

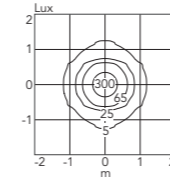
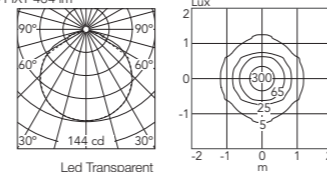

540 lm = FIXT 64 lm

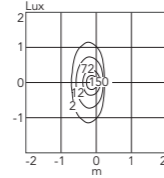
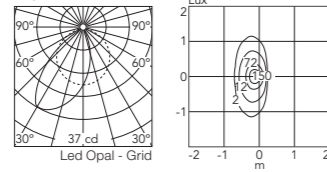

540 lm = FIXT 125 lm

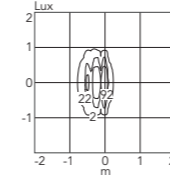
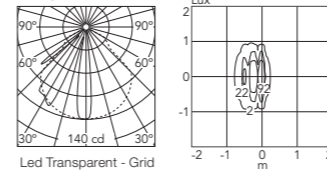

45 Adj Led 3

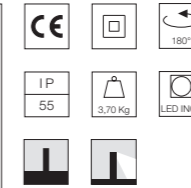
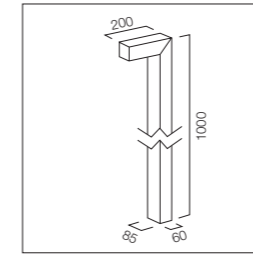

Completare con diffusori obbligatori.

To be completed with the required diffusers.

Power Led: 9W - 540 lm - 3000K/CRI 80

- F0072030
- F0072054

540 lm = FIXT 207 lm

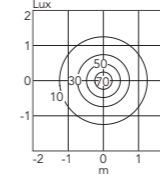
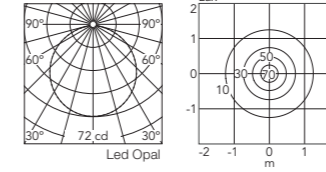

540 lm = FIXT 404 lm

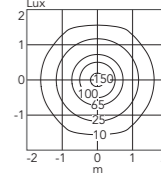
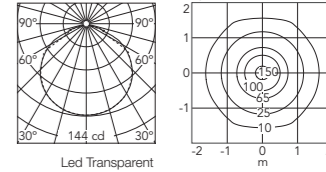

540 lm = FIXT 64 lm

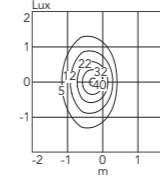
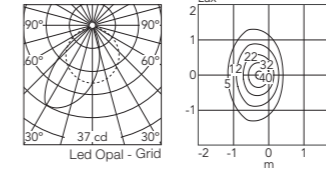

540 lm = FIXT 125 lm

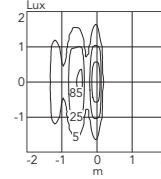
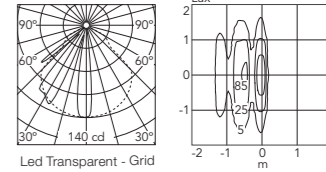

Accessori / Accessories

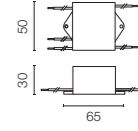
Diffusore ad alto comfort (opale).	High comfort diffuser (opal).	F0074071	
Diffusore ad alto rendimento (trasparente).	High performance diffuser (transparent).	F0074000	
Griglia anti-abbagliamento.	Low glare grid.	F0056030	
Palo da interrare.	Pole to be placed in the ground.	F0057000	
Flangia da cementare.	Flange to be cemented.	F0058000	
Dispositivo di protezione per il sovraccarico. 275 Vac. Corrente massima di scarica 10KA (8/29us). Massima corrente operativa 5A. Adatto per la connessione in serie. IP66.	Surge protection device. 275Vac. Maximum discharge current 10KA (8/20us). Maximum operating current 5A. Suitable for series connection. IP66.	F990E00A000	 

Real Matter



Designed by Piero Lissoni



Real Matter



Famiglia / Family

Real Matter



Low - Power Led

3W

71 lm - 2700K/CRI 80

82 lm - 3000K/CRI 80

Descrizione / Description

Apparecchio da esterni per installazione a incasso a parete con fonte di luce a LED.

Corpo in acciaio inox AISI 316L trattato con processo PVD (Physical Vapour Deposition). Grazie a questo innovativo trattamento, dopo il processo di lucidatura o spazzolatura secondo la finitura scelta, le superfici del Real Matter sono ricoperte da un sottile film di metalli come zirconio e titanio che, combinandosi con l'acciaio a livello molecolare, ne aumentano le caratteristiche di resistenza sia meccanica che agli agenti atmosferici, permettendo la realizzazione di finiture pregiate e durevoli.

Diffusore in policarbonato stabilizzato ai raggi UV.

L'apparecchio è fornito con due cavi di alimentazione uscenti L 200mm e con un kit per la connessione a tenuta IP. È necessario utilizzare una cassaforma, da ordinare separatamente.

L'alimentatore elettrico a 24V può essere installato in remoto o alloggiato posteriormente all'apparecchio nella cassaforma.

Prodotto in 3 differenti versioni in base alla modalità di installazione:

- in muratura o in cemento con apposita cassaforma da incasso.

- in parete di cartongesso con apposite molle.

- in muratura o in cemento senza cassaforma da incasso:

l'apparecchio viene incollato direttamente sulla superficie.

Luminaire for outdoor use for built-in installation on the wall with LED light source.

Body made of stainless steel AISI 316L treated with the PVD process (Physical Vapour Deposition). Thanks to this innovative treatment, after the polishing or brushing process, according to the finishing choice, the surfaces of Real Matter are coated with a thin film of metals such as zirconium and titanium which, combining with the steel at the molecular level, increase the characteristics of resistance to both mechanical and to atmospheric agents, allowing the realization of elegant and durable finishings.

UV-stabilized polycarbonate diffuser.

The luminaire is provided with two L 200 mm length outgoing power cables and with a kit for the hermetic IP connection. It is necessary to use an installation box, to be ordered separately.

24V power supply may be installed remotely or housed at the back of the luminaire in the box for installation.

3 version available select the model suitable for your type of installation:

- in concrete surface with recessed box to.

- in plasterboard surface supplied with springs.

- on solid surface no recessed box needed, the fixtures is directly glued on the surface.

Colori / Colours

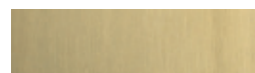

44 Brushed Gold



47 Brushed Bronze



55 Brushed Stainless Steel



66 Polished Copper

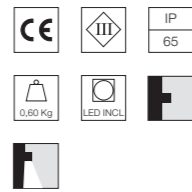
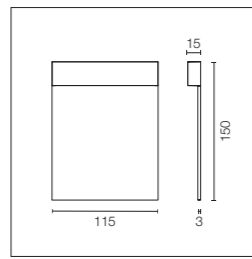

Alimentazione elettrica remota 24V da ordinare separatamente. Apparecchio fornito con due cavi di alimentazione da 200 mm e kit per la connessione IP. Prodotto in 3 differenti versioni; ordinare il codice corretto in base alla modalità di installazione:
 - in muratura o in cemento con apposita cassaforma da incasso da ordinare separatamente.
 - in parete di cartongesso con apposite molle incluse (per contropareti spessore min 5 mm- max 20 mm).
 - in muratura o in cemento senza cassaforma da incasso: l'apparecchio viene incollato direttamente sulla superficie (collante da scegliere a cura dell'installatore in base al materiale su cui andrà installato l'apparecchio).

Remote power supply 24V to be ordered separately. The fixture is prewired with 200mm cable and an IP connection kit.
 3 version available (select the model suitable for your type of installation):
 - in concrete surface with recessed box to be ordered separately.
 - in plasterboard surface (surface thickness min 5mm- max20mm) model supplied with springs.
 - on solid surface no recessed box needed, the fixtures is directly glued on the surface (type of gluing to be select by the operator based on the type of surface).

Low-Power Led: 3W - 180 lm ≠ FIXT 71 lm - 2700K/CRI 80 - 24V / 3W - 200 lm ≠ FIXT 82 lm - 3000K/CRI 80 - 24V

2700K

Installazione in muratura con cassaforma/
 Installation in masonry with box for installation

- F5960044
- F5960047
- F5960055
- F5960066

3000K

- F5961044
- F5961047
- F5961055
- F5961066

Installazione in parete di cartongesso (min 5mm - max 20mm)/
 Installation in plasterboard wall

- F5980044
- F5980047
- F5980055
- F5980066

- F5981044
- F5981047
- F5981055
- F5981066

Installazione in muratura senza cassaforma/
 Installation in masonry without box for installation

- F5970044
- F5970047
- F5970055
- F5970066

- F5971044
- F5971047
- F5971055
- F5971066

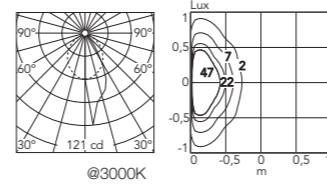

Cassaforma per muratura o parete in cemento.

Box for installation for masonry or concrete wall.

F5962000

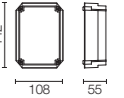

Installazione in Muratura con Cassaforma / Installation in Masonry with Box for Installation

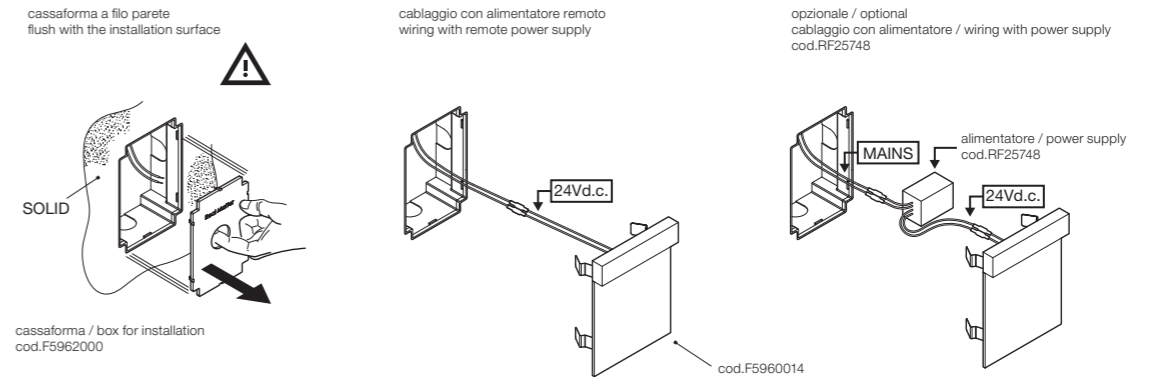

Installazione in Parete di Cartongesso / Installation in Plasterboard Wall

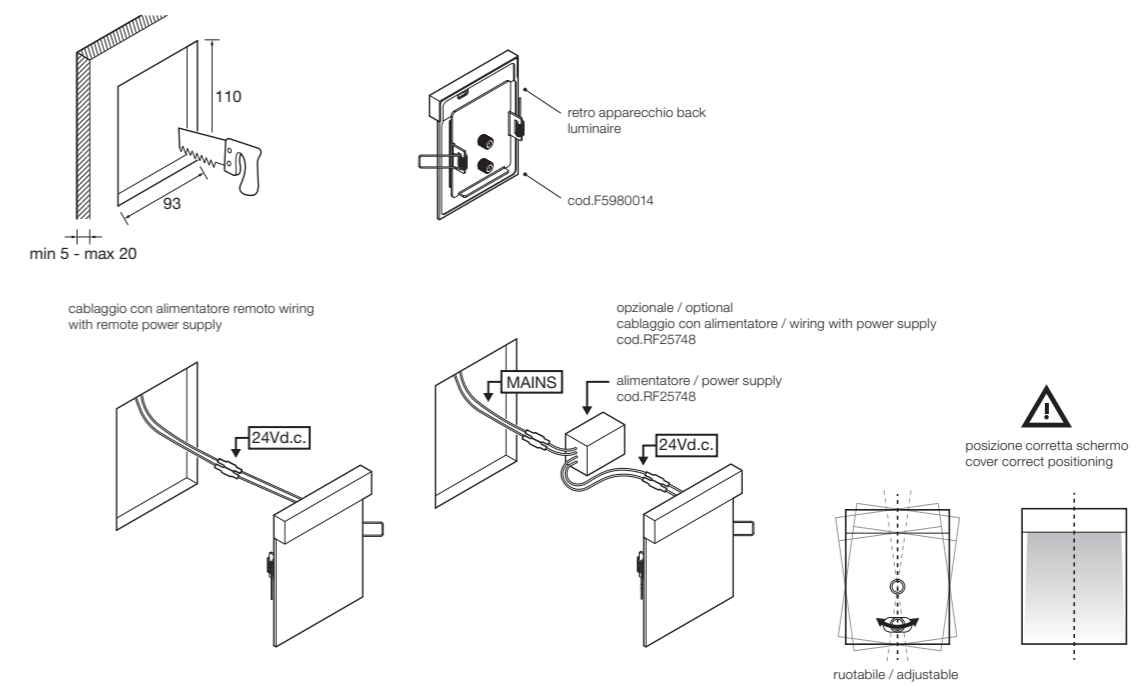

Installazione in Muratura senza Cassaforma / Installation in Masonry without Box for Installation

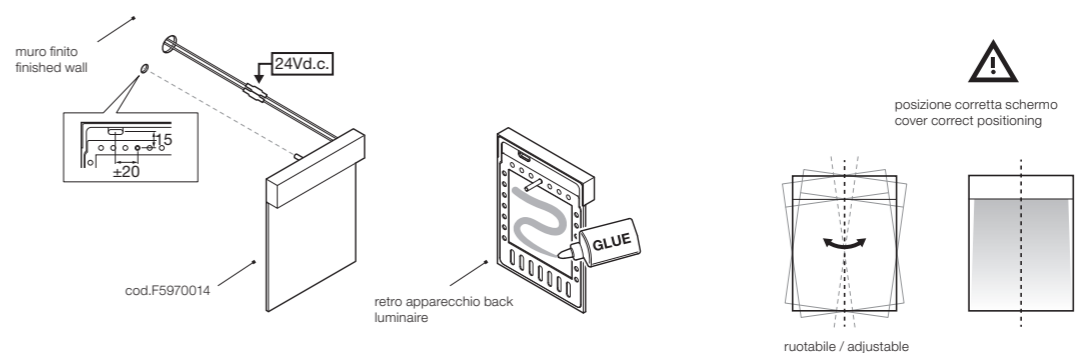



Real Matter: Driver / Drivers

Alimentatore 24Vdc 8W / 110-240V IP65 Classe II selv.	Power supply 24Vdc 8W / 110-240V IP65 Class II selv.	*RF25748		
Può essere alloggiato nella cassaforma F5962000.	It can be housed in installation box F5962000.			
Alimentatore per installazione remota 24Vdc 10W / 110-240V IP20 Classe II selv.	Power supply for remote installation 24Vdc 10W / 110-240V IP20 Class II selv.	*RF25747		
Alimentatore per installazione remota 24Vdc 20W / 220-240V IP67 Classe II selv.	Power supply for remote installation 24Vdc 20W / 220-240V IP67 Class II selv.	*RF25752		
Alimentatore per installazione remota 24Vdc 50W / 120-240V IP67 Classe II selv.	Power supply for remote installation 24Vdc 50W / 120-240V IP67 Class II selv.	*RF25755		
Alimentatore 24Vdc 35W / 120-270V IP67 Classe II selv.	Power supply 24Vdc 35W / 120-270V IP67 Class II selv.	*F990B23AZ00		
Alimentatore per installazione remota 24Vdc 70W / 220-240V IP67 Classe II selv.	Power supply for remote installation 24Vdc 70W / 220-240V IP67 Class II selv.	*RF25749		
Alimentatore per installazione remota 24Vdc 96W / 120-240V IP67 Classe II selv.	Power supply for remote installation 24Vdc 96W / 120-240V IP67 Class II selv.	*RF25756		

* Numero massimo di apparecchi per alimentatore / Maximum number of luminaires per power supply.

Numero massimo di apparecchi per alimentatore (Vin220÷240). Dati indicativi da verificare con le specifiche condizioni di installazione.	Maximum number of luminaires per power supply. (220÷240 V). These data must be checked taking into account the specific installation conditions.	Acc.	
		Acc. RF25748	2
		Acc. RF25747	3
		Acc. RF25757	3
		Acc. RF25752	5
		Acc. F990B23AZ00	9
		Acc. RF25755	13
		Acc. RF25749	19
		Acc. RF25756	27

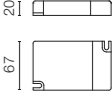
Real Matter: Driver / Drivers

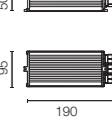
Alimentatore per installazione remota 24Vdc 17W / 110-240V (15W@110V) IP20 Classe II selv.	Power supply for remote installation 24Vdc 17W / 110-240V (15W@110V) IP20 Class II selv.	*RF25750 Dimmable 1-10V		
Alimentatore per installazione remota 24Vdc 20W / 110-240Vdc (15W@110V) IP67 Classe II selv.	Power supply for remote installation 24Vdc 20W / 110-240Vdc (15W@110V) IP67 Class II selv.	*RF26387 Dimmable DALI		

* Numero massimo di apparecchi per alimentatore / Maximum number of luminaires per power supply.

Numero massimo di apparecchi per alimentatore (Vin220÷240). Dati indicativi da verificare con le specifiche condizioni di installazione.	Maximum number of luminaires per power supply. (220÷240 V). These data must be checked taking into account the specific installation conditions.	Acc.	
		Acc. RF25750	4
		Acc. RF26387	5

My Way



Designed by Piero Lissoni



Famiglia / Family

My Way 110 x 100



Mid - Power Led

5W
188 lm - 2700K/CRI 80
211 lm - 3000K/CRI 80
221 lm - 4000K/CRI 80

My Way 110 x 200



Mid - Power Led

13W
657 lm - 2700K/CRI 80
763 lm - 3000K/CRI 80
801 lm - 4000K/CRI 80

My Way 210 x 200



Mid - Power Led

13W
669 lm - 2700K/CRI 80
777 lm - 3000K/CRI 80
817 lm - 4000K/CRI 80

Descrizione / Description

Apparecchio da esterni per installazione a incasso a parete con fonte di luce a LED.

Corpo in alluminio pressofuso EN AB-47100 (a basso contenuto di rame).

Rivestimento ad alta resistenza: dopo un trattamento di sabbiatura di tutti i componenti per rendere la superficie porosa e garantire una maggiore adesione della vernice, è applicato il rivestimento esterno con un doppio strato con polveri secondo lo standard QUALICOAT. Il primo strato di polvere epossidica dà resistenza chimica e meccanica, il secondo strato di finitura di polvere poliestere assicura resistenza ai raggi UV ed agli agenti atmosferici.

Le superfici verniciate sono trattate con lavaggi alcalini e acidi, risciacquate con acqua demineralizzata e sottoposte a un trattamento di conversione chimica per proteggere contro l'ossidazione.

Diffusore in policarbonato satinato, stabilizzato ai raggi UV, incollato alla testa del prodotto per garantire la tenuta all'acqua.

Luminaire for outdoor use for built-in installation on the wall with LED light source.

Aluminum die-cast body EN AB-47100 (low copper content).

High-resistance coating: after a sandblasting treatment of all components to make the surface porous and ensure a greater adhesion of the paint, the external coating is applied with a double layer with epoxy powders according to the QUALICOAT standard. The first layer of epoxy powder gives chemical and mechanical resistance, the second finishing layer of polyester powder ensures resistance to UV rays and atmospheric agents.

The painted surfaces are treated with alkaline and acidic washes, then rinsed with demineralized water, subjected to a chemical conversion treatment to protect against oxidation. Frosted polycarbonate diffuser, UV-stabilised, glued to the head of the product to ensure a watertight seal.

Colori / Colours



01 White



06 Grey



12 Forest Green



18 Deep Brown



30 Black



33 Anthracite

Camouflage



Designed by Piero Lissoni

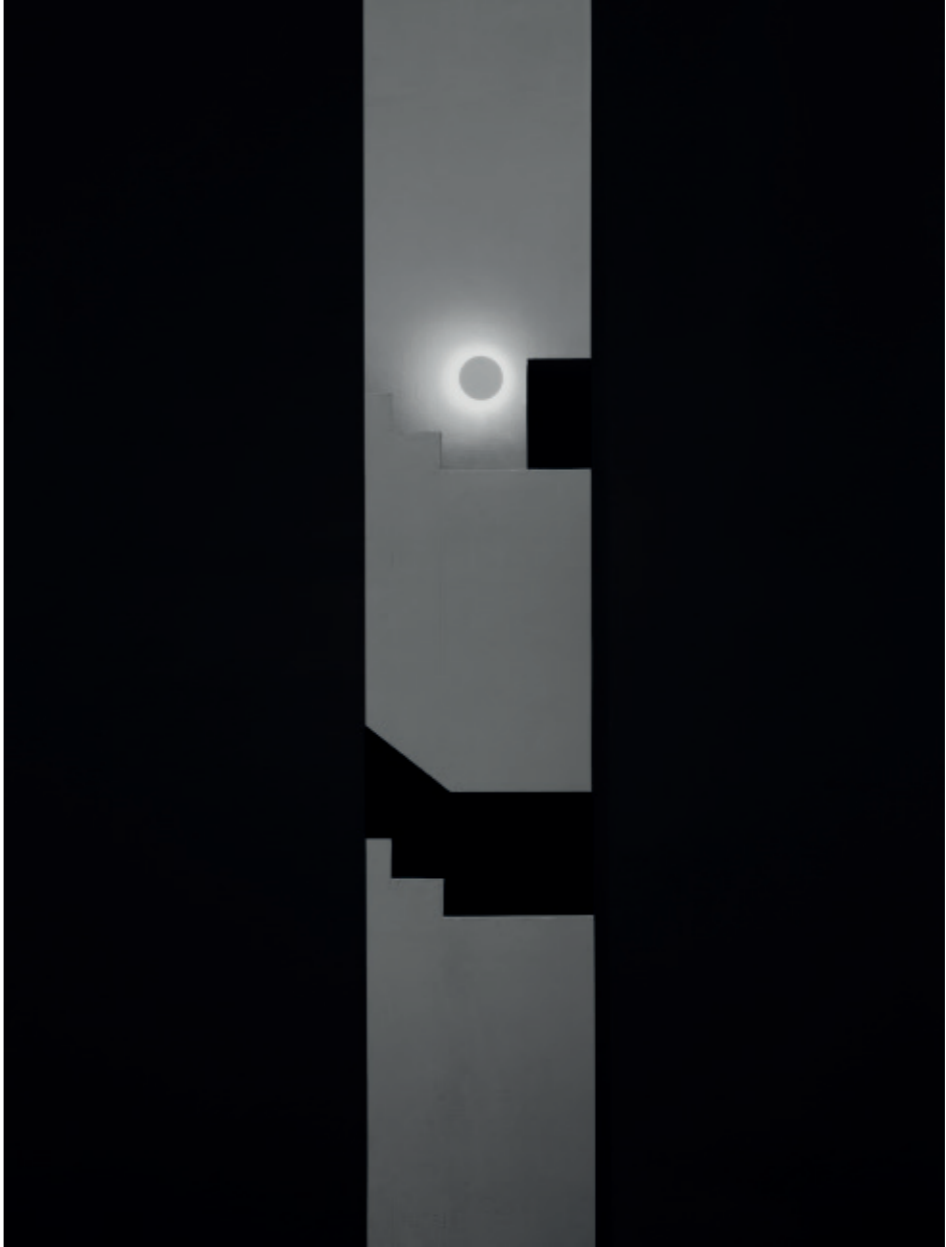

Camouflage

Famiglia / Family

Camouflage 140



Mid - Power Led

8W

474 lm - 2700K/CRI 80

551 lm - 3000K/CRI 80

579 lm - 4000K/CRI 80

Camouflage 240



Mid - Power Led

12W

773 lm - 2700K/CRI 80

898 lm - 3000K/CRI 80

944 lm - 4000K/CRI 80

Descrizione / Description

Collezione di prodotti da esterno, per installazione a parete con fonte di luce a LED.

Corpo dissipante in alluminio con diffusore in policarbonato trasparente.

Le finiture pietra Crema D'Orcia e Basaltina sono realizzate fissando mediante collante ad altissima resistenza una placca di pietra creata attraverso processo di lavorazione meccanica dal pieno.

La finitura calcestruzzo è realizzata fissando mediante collante monocomponente ad altissima resistenza una placca realizzata in cemento colato rinforzato con fibra di vetro. La versione Primer va verniciata dopo l'installazione con normali colorazioni a base acquosa (tempere, stucchi, vernici ad acqua) per garantire la massima omogeneità con l'architettura. Le versioni in alluminio sono finite con un rivestimento ad alta resistenza: dopo un trattamento di sabbiatura di tutti i componenti per rendere la superficie porosa e garantire una maggiore adesione della vernice, è applicato il rivestimento esterno con un doppio strato con polveri secondo lo standard QUALICOAT. Il primo strato di polvere epossidica dà resistenza chimica e meccanica, il secondo strato di finitura di polvere poliestere assicura resistenza ai raggi UV ed agli agenti atmosferici.

Le superfici verniciate sono trattate con lavaggi alcalini e acidi, risciacquate con acqua demineralizzata, e sottoposte a un trattamento di conversione chimica per proteggere contro l'ossidazione.

Previa valutazione commerciale e tecnica, è possibile realizzare versioni personalizzate con altri materiali a richiesta.

Collection of products for outdoor use, for wall installation with LED light source

Dissipating aluminum body with diffuser in transparent polycarbonate.

The Crema d'Orcia and Basaltina stone finishes are made by fastening high-strength, high-resistance adhesive to a stone plate created by means of mechanical machining from a solid block.

The concrete finishing is made by fastening a poured cement plate reinforced with fiberglass using a single component high strength, high-resistance adhesive. The Primer version is painted after installation with normal water-based colors (tempera, stucco, water-based paints) to ensure maximum uniformity with the architecture.

The aluminum versions are finished with a high-resistance coating: after a sandblasting treatment of all components to make the surface porous and ensure a greater adhesion of the paint, the external coating is applied with a double layer with epoxy powders according to the QUALICOAT standard. The first layer of epoxy powder gives chemical and mechanical resistance, the second finishing layer of polyester powder ensures resistance to UV rays and atmospheric agents.

The painted surfaces are treated with alkaline and acidic washes, then rinsed with demineralized water, subjected to a chemical conversion treatment to protect against oxidation. Upon commercial and technical evaluation, it is possible to create customized versions with other materials on request.

Colori / Colours

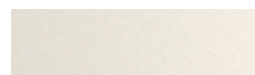

00 Primer



01 White



06 Grey



12 Forest Green



18 Deep Brown



30 Black



33 Anthracite

Camouflage Stone



87 Basaltina Stone

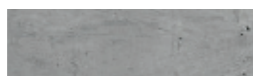

89 Concrete

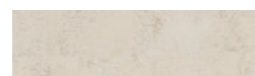

90 Crema d'Orcia Stone

Camouflage 140

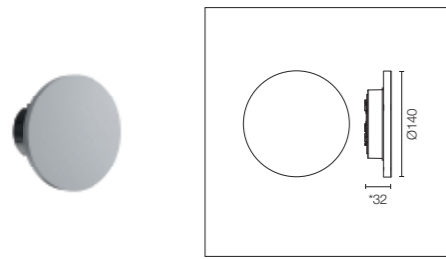

*Concrete, crema d'orcio, basaltina H = 35 mm.

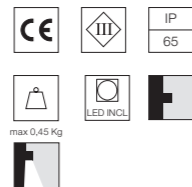

Alimentazione elettrica remota da 24V da ordinare separatamente. Include cavo di alimentazione di 100 mm. L'alimentatore può essere installato remoto (cassaforma non necessaria) o alloggiato posteriormente all'apparecchio mediante apposita cassaforma opzionale.

24V remote power supply to be ordered separately. Includes power cable of 100 mm. The power supply can be installed remotely (installation box not required) or housed at the back of the luminaire in the optional installation box.

Mid-Power Led: 8W - 786 lm ≠ FIXT 474 lm - 2700K/CRI 80 - 24V / 8W - 913 lm ≠ FIXT 551 lm - 3000K/CRI 80 - 24V / 8W - 960 lm ≠ FIXT 579 lm - 4000K/CRI 80 - 24V

- | 2700K | 3000K | 4000K |
|------------|------------|------------|
| ● F1310000 | ● F1311000 | ● F1312000 |
| ○ F1310001 | ○ F1311001 | ○ F1312001 |
| ● F1310006 | ● F1311006 | ● F1312006 |
| ● F1310012 | ● F1311012 | ● F1312012 |
| ● F1310018 | ● F1311018 | ● F1312018 |
| ● F1310030 | ● F1311030 | ● F1312030 |
| ● F1310033 | ● F1311033 | ● F1312033 |
| ● F1310087 | ● F1311087 | ● F1312087 |
| ● F1310089 | ● F1311089 | ● F1312089 |
| ● F1310090 | ● F1311090 | ● F1312090 |

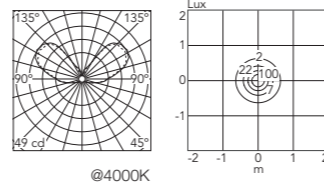

Dimmable 1-10V with code RF25750
Dimmable Dali with code RF26387

Camouflage 240

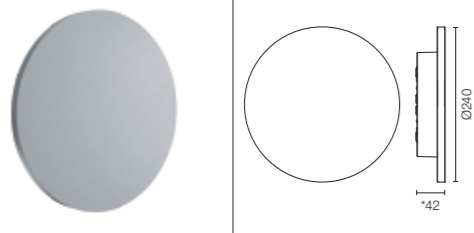

*Concrete, crema d'orcio, basaltina H = 48 mm.

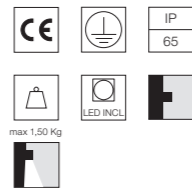

Alimentazione elettrica 220/240V integrata. Dotata di uno spezzone di cavo uscente in neoprene di 1000 mm. Versione 110V disponibile a richiesta.

Integrated 220/240V power supply. Supplied with a 1000 mm length outgoing neoprene cable. Version 110V upon request.

Mid-Power Led: 12W - 1281 lm ≠ FIXT 773 lm - 2700K/CRI 80 - 220-240V / 12W - 1488 lm ≠ FIXT 898 lm - 3000K/CRI 80 - 220-240V / 12W - 1563 lm ≠ FIXT 944 lm - 4000K/CRI 80 - 220-240V

- | 2700K | 3000K | 4000K |
|----------------|----------------|----------------|
| Non Dimmable | Non Dimmable | Non Dimmable |
| ● F1315000 | ● F1316000 | ● F1317000 |
| ○ F1315001 | ○ F1316001 | ○ F1317001 |
| ● F1315006 | ● F1316006 | ● F1317006 |
| ● F1315012 | ● F1316012 | ● F1317012 |
| ● F1315018 | ● F1316018 | ● F1317018 |
| ● F1315030 | ● F1316030 | ● F1317030 |
| ● F1315033 | ● F1316033 | ● F1317033 |
| ● F1315087 | ● F1316087 | ● F1317087 |
| ● F1315089 | ● F1316089 | ● F1317089 |
| ● F1315090 | ● F1316090 | ● F1317090 |
| 1-10V | 1-10V | 1-10V |
| ● F1315000-310 | ● F1316000-310 | ● F1317000-310 |
| ○ F1315001-310 | ○ F1316001-310 | ○ F1317001-310 |
| ● F1315006-310 | ● F1316006-310 | ● F1317006-310 |
| ● F1315012-310 | ● F1316012-310 | ● F1317012-310 |
| ● F1315018-310 | ● F1316018-310 | ● F1317018-310 |
| ● F1315030-310 | ● F1316030-310 | ● F1317030-310 |
| ● F1315033-310 | ● F1316033-310 | ● F1317033-310 |
| ● F1315087-310 | ● F1316087-310 | ● F1317087-310 |
| ● F1315089-310 | ● F1316089-310 | ● F1317089-310 |
| ● F1315090-310 | ● F1316090-310 | ● F1317090-310 |
| Dali | Dali | Dali |
| ● F1315000-300 | ● F1316000-300 | ● F1317000-300 |
| ○ F1315001-300 | ○ F1316001-300 | ○ F1317001-300 |
| ● F1315006-300 | ● F1316006-300 | ● F1317006-300 |
| ● F1315012-300 | ● F1316012-300 | ● F1317012-300 |
| ● F1315018-300 | ● F1316018-300 | ● F1317018-300 |
| ● F1315030-300 | ● F1316030-300 | ● F1317030-300 |
| ● F1315033-300 | ● F1316033-300 | ● F1317033-300 |
| ● F1315087-300 | ● F1316087-300 | ● F1317087-300 |
| ● F1315089-300 | ● F1316089-300 | ● F1317089-300 |
| ● F1315090-300 | ● F1316090-300 | ● F1317090-300 |

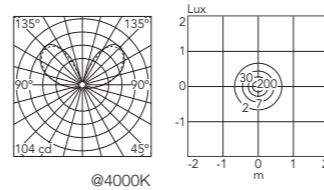

Camouflage 140: Accessori / Accessories

Dispositivo di protezione per il sovraccarico. 275 Vac. Corrente massima di scarica 10KA (8/29us). Massima corrente operativa 5A. Adatto per la connessione in serie. IP66.

Surge protection device. 275Vac. Maximum discharge current 10KA (8/20us). Maximum operating current 5A. Suitable for series connection. IP66.

F990E00A000

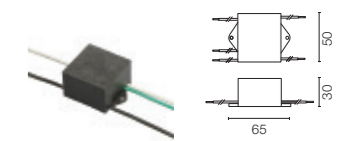

Cassaforma.

Box for installation.

F1318000

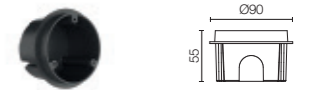

Fissaggio a Parete / Installation on Wall

Option 1

Senza cassaforma / Surface installation

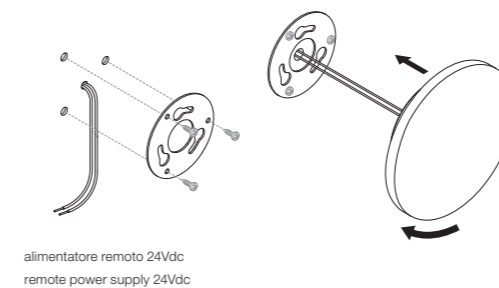

alimentatore remoto 24Vdc
remote power supply 24Vdc

Option 2

Con cassaforma / Recessed box installation

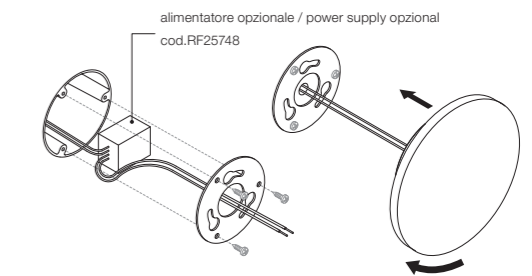

cassaforma a filo parete
flush with the installation surface

cassaforma / installation box
cod. F1318000



Camouflage: Driver / Drivers

Alimentatore per installazione remota 24Vdc 8W / 110-240V IP65 Classe II selv.	Power supply for remote installation 24Vdc 8W / 110-240V IP65 Class II selv.	*RF25748		
Può essere alloggiato nella cassaforma F1318000.	It can be housed in installation box F1318000.			
Alimentatore per installazione remota 24Vdc 10W / 110-240V IP20 Classe II selv.	Power supply for remote installation 24Vdc 10W / 110-240V IP20 Class II selv.	*RF25747		
Alimentatore per installazione remota 24Vdc 20W / 220-240V IP67 Classe II selv.	Power supply for remote installation 24Vdc 20W / 220-240V IP67 Class II selv.	*RF25752		
Alimentatore 24Vdc 35W / 120-270V IP67 Classe II selv.	Power supply 24Vdc 35W / 120-270V IP67 Class II selv.	*F990B23AZ00		
Alimentatore per installazione remota 24Vdc 50W / 120-240V IP67 Classe II selv.	Power supply for remote installation 24Vdc 50W / 120-240V IP67 Class II selv.	*RF25755		
Alimentatore per installazione remota 24Vdc 70W / 220-240V IP67 Classe II selv.	Power supply for remote installation 24Vdc 70W / 220-240V IP67 Class II selv.	*RF25749		
Alimentatore per installazione remota 24Vdc 96W / 120-240V IP67 Classe II selv.	Power supply for remote installation 24Vdc 96W / 120-240V IP67 Class II selv.	*RF25756		

* Numero massimo di apparecchi per alimentatore / Maximum number of luminaires per power supply.

Numero massimo di apparecchi per alimentatore (Vin220-240). Dati indicativi da verificare con le specifiche condizioni di installazione.	Maximum number of luminaires per power supply. (220-240 V). These data must be checked taking into account the specific installation conditions.	Acc.	RF	Numero
		Acc.	RF25748	2
		Acc.	RF25747	3
		Acc.	RF25757	3
		Acc.	RF25752	5
		Acc.	F990B23AZ00	9
		Acc.	RF25755	13
		Acc.	RF25749	19
		Acc.	RF25756	27

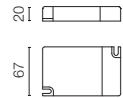
Camouflage: Driver / Drivers

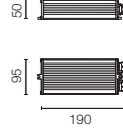
Alimentatore per installazione remota 24Vdc 17W / 110-240V (15W@110V) IP20 Classe II selv.	Power supply for remote installation 24Vdc 17W / 110-240V (15W@110V) IP20 Class II selv.	*RF25750		
Alimentatore per installazione remota 24Vdc 20W / 110-240Vdc (15W@110V) IP67 Classe II selv.	Power supply for remote installation 24Vdc 20W / 110-240Vdc (15W@110V) IP67 Class II selv.	*RF26387		

* Numero massimo di apparecchi per alimentatore / Maximum number of luminaires per power supply.

Numero massimo di apparecchi per alimentatore (Vin220-240). Dati indicativi da verificare con le specifiche condizioni di installazione.	Maximum number of luminaires per power supply. (220-240 V). These data must be checked taking into account the specific installation conditions.	Acc.	RF	Numero
		Acc.	RF25750	4
		Acc.	RF26387	5

Climber



Designed by Piero Lissoni



Climber

Famiglia / Family

Climber 87



Down

Power Led

7W

387 lm - 2700K/CRI 80

419 lm - 3000K/CRI 80

451 lm - 4000K/CRI 80

Up&Down

Power Led

12W

2x387 lm - 2700K/CRI 80

2x419 lm - 3000K/CRI 80

2x451 lm - 4000K/CRI 80

Climber 175



Down

Power Led

12W

721 lm - 2700K/CRI 80

781 lm - 3000K/CRI 80

841 lm - 4000K/CRI 80

Up&Down

Power Led

21W

2x721 lm - 2700K/CRI 80

2x781 lm - 3000K/CRI 80

2x841 lm - 4000K/CRI 80

Climber 275



Down

Power Led

21W

1240 lm - 2700K/CRI 80

1344 lm - 3000K/CRI 80

1447 lm - 4000K/CRI 80

Up&Down

Power Led

40W

2x1240 lm - 2700K/CRI 80

2x1344 lm - 3000K/CRI 80

2x1447 lm - 4000K/CRI 80

Descrizione / Description

Apparecchio da esterni per installazione a parete con fonte di luce a LED.

Versioni bi-emissione e mono emissione verso il basso.

Corpo in alluminio pressofuso EN AB-47100, a basso contenuto di rame, con alloggiamento ottiche asimmetrico: l'ottica nella parte inferiore è arretrata e protetta da uno scuretto per limitare l'abbagliamento molesto e massimizzare il confort visivo. Nella versione bi-emissione, il vetro di chiusura dell'ottica superiore è a filo con il bordo lampada per evitare depositi d'acqua.

I diffusori in vetro microtesturizzato sono incollati per garantire l'impermeabilità, e testurizzati per assicurare l'uniformità del fascio luminoso generato da ogni singolo LED, mantenendo un'ottima efficienza luminosa.

Rivestimento ad alta resistenza: dopo un trattamento di sabbiatura di tutti i componenti per rendere la superficie porosa e garantire una maggiore adesione della vernice, è applicato il rivestimento esterno con un doppio strato con polveri secondo lo standard QUALICOAT. Il primo strato di polvere epossidica dà resistenza chimica e meccanica, il secondo strato di finitura di polvere poliestere assicura resistenza ai raggi UV ed agli agenti atmosferici.

Le superfici verniciate sono trattate con lavaggi alcalini e acidi, risciacquate con acqua demineralizzata e sottoposte a un trattamento di conversione chimica per proteggere contro l'ossidazione.

Luminaire for outdoor use for installation on the wall with LED light supply.

Bi-emission and mono-emission versions pointing downwards.

Aluminum die-cast body EN AB-47100, low copper content with asymmetrical optics housing: the optics in the lower part is retracted and protected by a shutter to restrict annoying glare and maximize visual comfort. In the bi-emission version, the glass of the closure of the upper optics is flush with the edge of the light in order to prevent water deposits.

The micro-texturized glass diffusers are glued to ensure water resistance and textured to ensure a uniform light beam generated by each single LED, maintaining excellent luminous efficiency.

High-resistance coating: after a sandblasting treatment of all components to make the surface porous and ensure a greater adhesion of the paint, the external coating is applied with a double layer with epoxy powders according to the QUALICOAT standard. The first layer of epoxy powder gives chemical and mechanical resistance, the second finishing layer of polyester powder ensures resistance to UV rays and atmospheric agents.

The painted surfaces are treated with alkaline and acidic washes, then rinsed with demineralized water, subjected to a chemical conversion treatment to protect against oxidation.

Colori / Colours



01 White



06 Grey



12 Forest Green

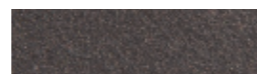

18 Deep Brown



30 Black

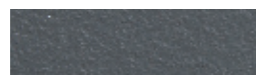

33 Anthracite

Climber 87 Down

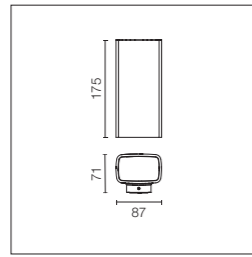

Alimentazione elettrica 110/240V integrata. Dotata di uno spezzone di cavo uscente in neoprene di 80 mm. A richiesta versione mono emissione verso l'alto/ UP.

Integrated 110/240V power supply. Supplied with an 80 mm lenght outgoing neoprene cable. Upwards, single emission version, available upon request.



Power Led: 7W - 432 lm ≠ *FIXT 387 lm - 2700K/CRI 80 - 110-240V / 7W - 468 lm ≠ *FIXT 419 lm - 3000K/CRI 80 - 110-240V / 7W - 504 lm ≠ *FIXT 451 lm - 4000K/CRI 80 - 110-240V
*FIXT lm = Spot Optic

Optic Spot

2700K

Non Dimmable

- F1110001
- F1110006
- F1110012
- F1110018
- F1110030
- F1110033
- 1-10V
- F1110001-310
- F1110006-310
- F1110012-310
- F1110018-310
- F1110030-310
- F1110033-310
- Dali
- F1110001-300
- F1110006-300
- F1110012-300
- F1110018-300
- F1110030-300
- F1110033-300

3000K

Non Dimmable

- F1112001
- F1112006
- F1112012
- F1112018
- F1112030
- F1112033
- 1-10V
- F1112001-310
- F1112006-310
- F1112012-310
- F1112018-310
- F1112030-310
- F1112033-310
- Dali
- F1112001-300
- F1112006-300
- F1112012-300
- F1112018-300
- F1112030-300
- F1112033-300

4000K

Non Dimmable

- F1114001
- F1114006
- F1114012
- F1114018
- F1114030
- F1114033
- 1-10V
- F1114001-310
- F1114006-310
- F1114012-310
- F1114018-310
- F1114030-310
- F1114033-310
- Dali
- F1114001-300
- F1114006-300
- F1114012-300
- F1114018-300
- F1114030-300
- F1114033-300

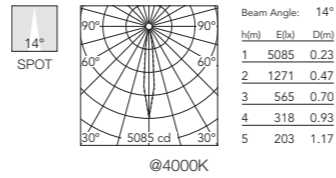

Climber 87 Up&Down

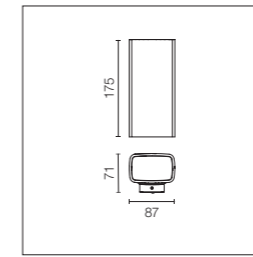

Alimentazione elettrica 110/240V integrata. Dotata di uno spezzone di cavo uscente in neoprene di 80 mm.

Integrated 110/240V power supply. Supplied with an 80 mm lenght outgoing neoprene cable.



Power Led: 12W - 2x432 lm ≠ *FIXT 2x392 lm - 2700K/CRI 80 - 110-240V / 12W - 2x468 lm ≠ *FIXT 2x425 lm - 3000K/CRI 80 - 110-240V / 12W - 2x504 lm ≠ *FIXT 2x458 lm - 4000K/CRI 80 - 110-240V
*FIXT lm = Spot Optic

Optic Spot

2700K

Non Dimmable

- F1116001
- F1116006
- F1116012
- F1116018
- F1116030
- F1116033
- 1-10V
- F1116001-310
- F1116006-310
- F1116012-310
- F1116018-310
- F1116030-310
- F1116033-310
- Dali
- F1116001-300
- F1116006-300
- F1116012-300
- F1116018-300
- F1116030-300
- F1116033-300

3000K

Non Dimmable

- F1118001
- F1118006
- F1118012
- F1118018
- F1118030
- F1118033
- 1-10V
- F1118001-310
- F1118006-310
- F1118012-310
- F1118018-310
- F1118030-310
- F1118033-310
- Dali
- F1118001-300
- F1118006-300
- F1118012-300
- F1118018-300
- F1118030-300
- F1118033-300

4000K

Non Dimmable

- F1120001
- F1120006
- F1120012
- F1120018
- F1120030
- F1120033
- 1-10V
- F1120001-310
- F1120006-310
- F1120012-310
- F1120018-310
- F1120030-310
- F1120033-310
- Dali
- F1120001-300
- F1120006-300
- F1120012-300
- F1120018-300
- F1120030-300
- F1120033-300

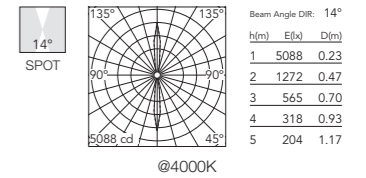

Optic Flood

2700K

Non Dimmable

- F1111001
- F1111006
- F1111012
- F1111018
- F1111030
- F1111033
- 1-10V
- F1111001-310
- F1111006-310
- F1111012-310
- F1111018-310
- F1111030-310
- F1111033-310
- Dali
- F1111001-300
- F1111006-300
- F1111012-300
- F1111018-300
- F1111030-300
- F1111033-300

3000K

Non Dimmable

- F1113001
- F1113006
- F1113012
- F1113018
- F1113030
- F1113033
- 1-10V
- F1113001-310
- F1113006-310
- F1113012-310
- F1113018-310
- F1113030-310
- F1113033-310
- Dali
- F1113001-300
- F1113006-300
- F1113012-300
- F1113018-300
- F1113030-300
- F1113033-300

4000K

Non Dimmable

- F1115001
- F1115006
- F1115012
- F1115018
- F1115030
- F1115033
- 1-10V
- F1115001-310
- F1115006-310
- F1115012-310
- F1115018-310
- F1115030-310
- F1115033-310
- Dali
- F1115001-300
- F1115006-300
- F1115012-300
- F1115018-300
- F1115030-300
- F1115033-300

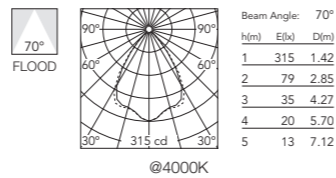

Optic Flood

2700K

Non Dimmable

- F1117001
- F1117006
- F1117012
- F1117018
- F1117030
- F1117033
- 1-10V
- F1117001-310
- F1117006-310
- F1117012-310
- F1117018-310
- F1117030-310
- F1117033-310
- Dali
- F1117001-300
- F1117006-300
- F1117012-300
- F1117018-300
- F1117030-300
- F1117033-300

3000K

Non Dimmable

- F1119001
- F1119006
- F1119012
- F1119018
- F1119030
- F1119033
- 1-10V
- F1119001-310
- F1119006-310
- F1119012-310
- F1119018-310
- F1119030-310
- F1119033-310
- Dali
- F1119001-300
- F1119006-300
- F1119012-300
- F1119018-300
- F1119030-300
- F1119033-300

4000K

Non Dimmable

- F1121001
- F1121006
- F1121012
- F1121018
- F1121030
- F1121033
- 1-10V
- F1121001-310
- F1121006-310
- F1121012-310
- F1121018-310
- F1121030-310
- F1121033-310
- Dali
- F1121001-300
- F1121006-300
- F1121012-300
- F1121018-300
- F1121030-300
- F1121033-300

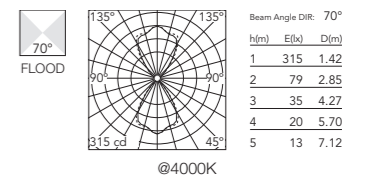

Climber 87: Accessori / Accessories

Dispositivo di protezione per il sovraccarico. 275Vac. Corrente massima di scarica 10KA (8/29µs). Massima corrente operativa 5A. Adatto per la connessione in serie. IP66.

Surge protection device. 275Vac. Maximum discharge current 10KA (8/20µs). Maximum operating current 5A. Suitable for series connection. IP66.

F990E00A000

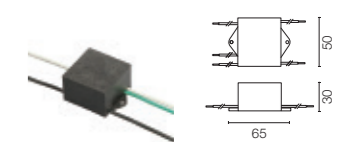

Climber 175 Down

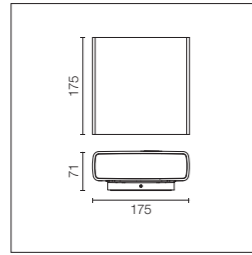

Alimentazione elettrica 110/240V integrata. Dotata di uno spezzone di cavo uscente in neoprene di 80 mm. A richiesta versione mono emissione verso l'alto/ UP.

Integrated 110/240V power supply. Supplied with an 80 mm length outgoing neoprene cable. Upwards, single emission version, available upon request.

Power Led: 12W - 864 lm ≠ *FIXT 721 lm - 2700K/CRI 80 - 110-240V / 12W - 936 lm ≠ *FIXT 781 lm - 3000K/CRI 80 - 110-240V / 12W - 1008 lm ≠ *FIXT 841 lm - 4000K/CRI 80 - 110-240V
*FIXT lm = Spot Optic

Optic Spot

2700K

Non Dimmable

- F1140001
- F1140006
- F1140012
- F1140018
- F1140030
- F1140033
- 1-10V
- F1140001-310
- F1140006-310
- F1140012-310
- F1140018-310
- F1140030-310
- F1140033-310
- Dali
- F1140001-300
- F1140006-300
- F1140012-300
- F1140018-300
- F1140030-300
- F1140033-300

3000K

Non Dimmable

- F1142001
- F1142006
- F1142012
- F1142018
- F1142030
- F1142033
- 1-10V
- F1142001-310
- F1142006-310
- F1142012-310
- F1142018-310
- F1142030-310
- F1142033-310
- Dali
- F1142001-300
- F1142006-300
- F1142012-300
- F1142018-300
- F1142030-300
- F1142033-300

4000K

Non Dimmable

- F1144001
- F1144006
- F1144012
- F1144018
- F1144030
- F1144033
- 1-10V
- F1144001-310
- F1144006-310
- F1144012-310
- F1144018-310
- F1144030-310
- F1144033-310
- Dali
- F1144001-300
- F1144006-300
- F1144012-300
- F1144018-300
- F1144030-300
- F1144033-300

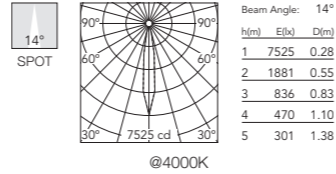

Climber 175 Up&Down

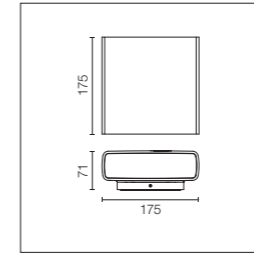

Alimentazione elettrica 220/240V integrata. Dotata di uno spezzone di cavo uscente in neoprene di 80 mm.

Integrated 220/240V power supply. Supplied with an 80 mm length outgoing neoprene cable.

Power Led: 21W - 2x864 lm ≠ *FIXT 2x739 lm - 2700K/CRI 80 - 220-240V / 21W - 2x936 lm ≠ *FIXT 2x800 lm - 3000K/CRI 80 - 220-240V / 21W - 2x1008 lm ≠ *FIXT 2x862 lm - 4000K/CRI 80 - 220-240V
*FIXT lm = Spot Optic

Optic Spot

2700K

Non Dimmable

- F1146001
- F1146006
- F1146012
- F1146018
- F1146030
- F1146033
- 1-10V
- F1146001-310
- F1146006-310
- F1146012-310
- F1146018-310
- F1146030-310
- F1146033-310
- Dali
- F1146001-300
- F1146006-300
- F1146012-300
- F1146018-300
- F1146030-300
- F1146033-300

3000K

Non Dimmable

- F1148001
- F1148006
- F1148012
- F1148018
- F1148030
- F1148033
- 1-10V
- F1148001-310
- F1148006-310
- F1148012-310
- F1148018-310
- F1148030-310
- F1148033-310
- Dali
- F1148001-300
- F1148006-300
- F1148012-300
- F1148018-300
- F1148030-300
- F1148033-300

4000K

Non Dimmable

- F1150001
- F1150006
- F1150012
- F1150018
- F1150030
- F1150033
- 1-10V
- F1150001-310
- F1150006-310
- F1150012-310
- F1150018-310
- F1150030-310
- F1150033-310
- Dali
- F1150001-300
- F1150006-300
- F1150012-300
- F1150018-300
- F1150030-300
- F1150033-300

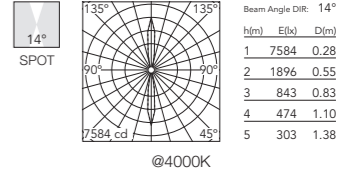

Optic Flood

2700K

Non Dimmable

- F1141001
- F1141006
- F1141012
- F1141018
- F1141030
- F1141033
- 1-10V
- F1141001-310
- F1141006-310
- F1141012-310
- F1141018-310
- F1141030-310
- F1141033-310
- Dali
- F1141001-300
- F1141006-300
- F1141012-300
- F1141018-300
- F1141030-300
- F1141033-300

3000K

Non Dimmable

- F1143001
- F1143006
- F1143012
- F1143018
- F1143030
- F1143033
- 1-10V
- F1143001-310
- F1143006-310
- F1143012-310
- F1143018-310
- F1143030-310
- F1143033-310
- Dali
- F1143001-300
- F1143006-300
- F1143012-300
- F1143018-300
- F1143030-300
- F1143033-300

4000K

Non Dimmable

- F1145001
- F1145006
- F1145012
- F1145018
- F1145030
- F1145033
- 1-10V
- F1145001-310
- F1145006-310
- F1145012-310
- F1145018-310
- F1145030-310
- F1145033-310
- Dali
- F1145001-300
- F1145006-300
- F1145012-300
- F1145018-300
- F1145030-300
- F1145033-300

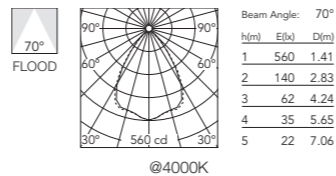

Optic Flood

2700K

Non Dimmable

- F1147001
- F1147006
- F1147012
- F1147018
- F1147030
- F1147033
- 1-10V
- F1147001-310
- F1147006-310
- F1147012-310
- F1147018-310
- F1147030-310
- F1147033-310
- Dali
- F1147001-300
- F1147006-300
- F1147012-300
- F1147018-300
- F1147030-300
- F1147033-300

3000K

Non Dimmable

- F1149001
- F1149006
- F1149012
- F1149018
- F1149030
- F1149033
- 1-10V
- F1149001-310
- F1149006-310
- F1149012-310
- F1149018-310
- F1149030-310
- F1149033-310
- Dali
- F1149001-300
- F1149006-300
- F1149012-300
- F1149018-300
- F1149030-300
- F1149033-300

4000K

Non Dimmable

- F1151001
- F1151006
- F1151012
- F1151018
- F1151030
- F1151033
- 1-10V
- F1151001-310
- F1151006-310
- F1151012-310
- F1151018-310
- F1151030-310
- F1151033-310
- Dali
- F1151001-300
- F1151006-300
- F1151012-300
- F1151018-300
- F1151030-300
- F1151033-300

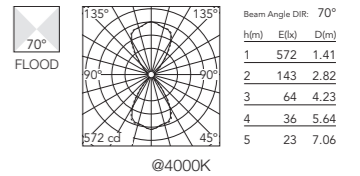

Climber 175: Accessori / Accessories

Dispositivo di protezione per il sovraccarico. 275Vac. Corrente massima di scarica 10KA (8/29µs). Massima corrente operativa 5A. Adatto per la connessione in serie. IP66.

Surge protection device. 275Vac. Maximum discharge current 10KA (8/20µs). Maximum operating current 5A. Suitable for series connection. IP66.

F990E00A000

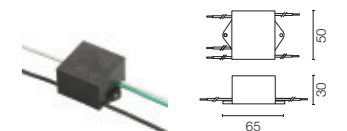

Climber 275 Down

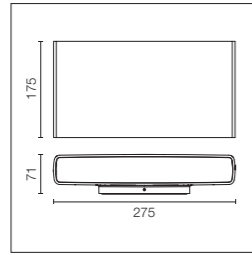

Alimentazione elettrica 110/240V integrata. Dotata di uno spezzone di cavo uscente in neoprene di 80 mm. A richiesta versione mono emissione verso l'alto/ UP.

Integrated 110/240V power supply. Supplied with an 80 mm length outgoing neoprene cable. Upwards, single emission version, available upon request.

Power Led: 21W - 1728 lm ≠ *FIXT 1240 lm - 2700K/CRI 80 - 220-240V / 21W - 1872 lm ≠ *FIXT 1344 lm - 3000K/CRI 80 - 220-240V / 21W - 2016 lm ≠ *FIXT 1447 lm - 4000K/CRI 80 - 220-240V
*FIXT lm = Spot Optic

Optic Spot

2700K

- Non Dimmable
- F1170001
- F1170006
- F1170012
- F1170018
- F1170030
- F1170033
- 1-10V
- F1170001-310
- F1170006-310
- F1170012-310
- F1170018-310
- F1170030-310
- F1170033-310
- Dali
- F1170001-300
- F1170006-300
- F1170012-300
- F1170018-300
- F1170030-300
- F1170033-300

3000K

- Non Dimmable
- F1172001
- F1172006
- F1172012
- F1172018
- F1172030
- F1172033
- 1-10V
- F1172001-310
- F1172006-310
- F1172012-310
- F1172018-310
- F1172030-310
- F1172033-310
- Dali
- F1172001-300
- F1172006-300
- F1172012-300
- F1172018-300
- F1172030-300
- F1172033-300

4000K

- Non Dimmable
- F1174001
- F1174006
- F1174012
- F1174018
- F1174030
- F1174033
- 1-10V
- F1174001-310
- F1174006-310
- F1174012-310
- F1174018-310
- F1174030-310
- F1174033-310
- Dali
- F1174001-300
- F1174006-300
- F1174012-300
- F1174018-300
- F1174030-300
- F1174033-300

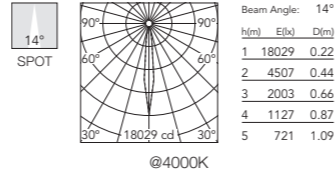

Climber 275 Up&Down

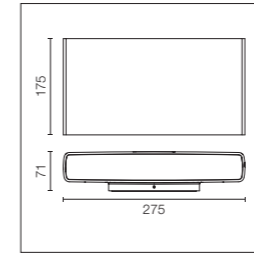

Alimentazione elettrica 220/240V integrata. Dotata di uno spezzone di cavo uscente in neoprene di 80 mm.

Integrated 220/240V power supply. Supplied with an 80 mm length outgoing neoprene cable.

Power Led: 40W - 2x1728 lm ≠ *FIXT 2x1264 lm - 2700K/CRI 80 - 220-240V / 40W - 2x1872 lm ≠ *FIXT 2x1370 lm - 3000K/CRI 80 - 220-240V / 40W - 2x2016 lm ≠ *FIXT 2x1475 lm - 4000K/CRI 80 - 220-240V
*FIXT lm = Spot Optic

Optic Spot

2700K

- Non Dimmable
- F1176001
- F1176006
- F1176012
- F1176018
- F1176030
- F1176033
- 1-10V
- F1176001-310
- F1176006-310
- F1176012-310
- F1176018-310
- F1176030-310
- F1176033-310
- Dali
- F1176001-300
- F1176006-300
- F1176012-300
- F1176018-300
- F1176030-300
- F1176033-300

3000K

- Non Dimmable
- F1178001
- F1178006
- F1178012
- F1178018
- F1178030
- F1178033
- 1-10V
- F1178001-310
- F1178006-310
- F1178012-310
- F1178018-310
- F1178030-310
- F1178033-310
- Dali
- F1178001-300
- F1178006-300
- F1178012-300
- F1178018-300
- F1178030-300
- F1178033-300

4000K

- Non Dimmable
- F1180001
- F1180006
- F1180012
- F1180018
- F1180030
- F1180033
- 1-10V
- F1180001-310
- F1180006-310
- F1180012-310
- F1180018-310
- F1180030-310
- F1180033-310
- Dali
- F1180001-300
- F1180006-300
- F1180012-300
- F1180018-300
- F1180030-300
- F1180033-300

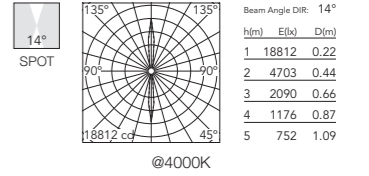

Optic Flood

2700K

- Non Dimmable
- F1171001
- F1171006
- F1171012
- F1171018
- F1171030
- F1171033
- 1-10V
- F1171001-310
- F1171006-310
- F1171012-310
- F1171018-310
- F1171030-310
- F1171033-310
- Dali
- F1171001-300
- F1171006-300
- F1171012-300
- F1171018-300
- F1171030-300
- F1171033-300

3000K

- Non Dimmable
- F1173001
- F1173006
- F1173012
- F1173018
- F1173030
- F1173033
- 1-10V
- F1173001-310
- F1173006-310
- F1173012-310
- F1173018-310
- F1173030-310
- F1173033-310
- Dali
- F1173001-300
- F1173006-300
- F1173012-300
- F1173018-300
- F1173030-300
- F1173033-300

4000K

- Non Dimmable
- F1175001
- F1175006
- F1175012
- F1175018
- F1175030
- F1175033
- 1-10V
- F1175001-310
- F1175006-310
- F1175012-310
- F1175018-310
- F1175030-310
- F1175033-310
- Dali
- F1175001-300
- F1175006-300
- F1175012-300
- F1175018-300
- F1175030-300
- F1175033-300

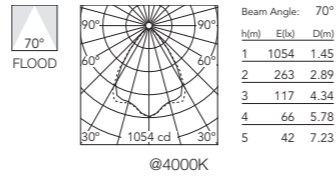

Optic Flood

2700K

- Non Dimmable
- F1177001
- F1177006
- F1177012
- F1177018
- F1177030
- F1177033
- 1-10V
- F1177001-310
- F1177006-310
- F1177012-310
- F1177018-310
- F1177030-310
- F1177033-310
- Dali
- F1177001-300
- F1177006-300
- F1177012-300
- F1177018-300
- F1177030-300
- F1177033-300

3000K

- Non Dimmable
- F1179001
- F1179006
- F1179012
- F1179018
- F1179030
- F1179033
- 1-10V
- F1179001-310
- F1179006-310
- F1179012-310
- F1179018-310
- F1179030-310
- F1179033-310
- Dali
- F1179001-300
- F1179006-300
- F1179012-300
- F1179018-300
- F1179030-300
- F1179033-300

4000K

- Non Dimmable
- F1181001
- F1181006
- F1181012
- F1181018
- F1181030
- F1181033
- 1-10V
- F1181001-310
- F1181006-310
- F1181012-310
- F1181018-310
- F1181030-310
- F1181033-310
- Dali
- F1181001-300
- F1181006-300
- F1181012-300
- F1181018-300
- F1181030-300
- F1181033-300

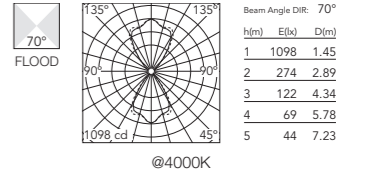

Climber 275: Accessori / Accessories

Dispositivo di protezione per il sovraccarico. 275Vac. Corrente massima di scarica 10KA (8/29µs). Massima corrente operativa 5A. Adatto per la connessione in serie. IP66.

Surge protection device. 275Vac. Maximum discharge current 10KA (8/20µs). Maximum operating current 5A. Suitable for series connection. IP66.

F990E00A000

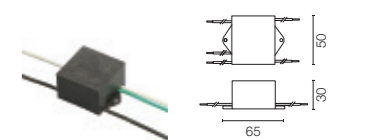

Heavy Metal



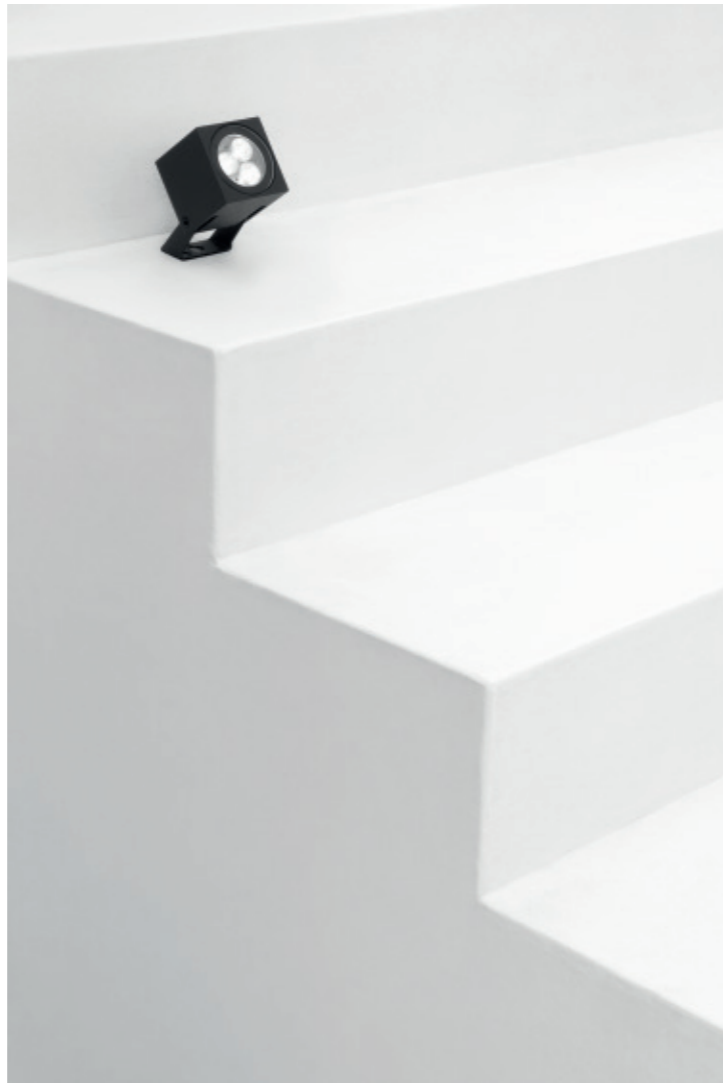

Heavy Metal Spot



Heavy Metal Wall 1

Famiglia / Family

Heavy Metal Spot 1



Power Led

up to 3,4W
up to 138 lm - 2700K/CRI 80
up to 149 lm - 3000K/CRI 80
up to 155 lm - 4000K/CRI 80
* Net lumen output

Power Led

up to 4,5W
up to 246 lm - 2700K/CRI 80
up to 267 lm - 3000K/CRI 80
up to 277 lm - 4000K/CRI 80
* Net lumen output

Heavy Metal Spot 2



Power Led

up to 5,9W
up to 364 lm - 2700K/CRI 80
up to 395 lm - 3000K/CRI 80
up to 410 lm - 4000K/CRI 80
* Net lumen output

Heavy Metal Wall 1



Power Led

up to 3,4W
up to 138 lm - 2700K/CRI 80
up to 149 lm - 3000K/CRI 80
up to 155 lm - 4000K/CRI 80
* Net lumen output

Power Led

up to 4,5W
up to 246 lm - 2700K/CRI 80
up to 267 lm - 3000K/CRI 80
up to 277 lm - 4000K/CRI 80
* Net lumen output

Heavy Metal Wall 2 Mono / Double



Power Led

up to 3,4W
up to 138 lm - 2700K/CRI 80
up to 149 lm - 3000K/CRI 80
up to 155 lm - 4000K/CRI 80
* Net lumen output

Power Led

up to 4,5W
up to 246 lm - 2700K/CRI 80
up to 267 lm - 3000K/CRI 80
up to 277 lm - 4000K/CRI 80
* Net lumen output

Power Led

up to 6,8W
up to 2x138 lm - 2700K/CRI 80
up to 2x149 lm - 3000K/CRI 80
up to 2x155 lm - 4000K/CRI 80
* Net lumen output

Power Led

up to 9W
up to 2x246 lm - 2700K/CRI 80
up to 2x267 lm - 3000K/CRI 80
up to 2x277 lm - 4000K/CRI 80
* Net lumen output

Heavy Metal Wall 3 Mono / Double



Mid-Power Led

up to 2,5W
up to 125 lm - 2700K/CRI 80
up to 134 lm - 3000K/CRI 80
up to 142 lm - 4000K/CRI 80
* Net lumen output

Mid-Power Led

up to 5W
up to 2x125 lm - 2700K/CRI 80
up to 2x134 lm - 3000K/CRI 80
up to 2x142 lm - 4000K/CRI 80
* Net lumen output

Colori / Colours



01 White



06 Grey



12 Forest Green

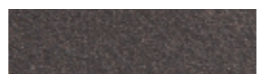

18 Deep Brown



30 Black



33 Anthracite

Descrizione / Description

Famiglia completa di apparecchi di illuminazione con sorgente luminosa a LED, in differenti finiture con rivestimento a doppio strato di polveri e sottoposte a trattamento di conversione chimica superficiale per una elevata resistenza alla corrosione. Le viterie di fissaggio sono in acciaio inox AISI 316L.

Heavy Metal Spot

Proiettore ultracompatto orientabile predisposto per installazione a soffitto, a parete e a terra con picchetto da ordinare separatamente. Disponibile in due tagli dimensionali (50x50 mm e 70x70 mm) e differenti fasci di apertura per coprire molteplici richieste illuminotecniche. Corpo in alluminio tornito lega EN AW 6060 e staffa di fissaggio in acciaio inox AISI 316L, verniciata coerentemente alla finitura apparecchio per un perfetto abbinamento. La staffa permette una orientabilità di 180° sull'asse verticale e una minima orientabilità di 20° sull'asse orizzontale per direzionare il fascio in base alle esigenze. Diffusore in vetro extrachiaro con bordo serigrafato, fissato attraverso un sistema di incollaggio robotizzato. Apparecchio in 24V dc, necessita di alimentatore remoto da ordinare separatamente.

Heavy Metal Wall 1

Apparecchio installabile a parete. Disponibile con emissione luminosa monodirezionale e con differenti fasci di apertura per coprire molteplici richieste illuminotecniche. Corpo in alluminio tornito lega EN AW 6060, piastra di fissaggio a parete in acciaio inox AISI 316L. Diffusore in vetro extra chiaro con bordo serigrafato, fissato attraverso un sistema di incollaggio robotizzato. Apparecchio in 24V dc, necessita di alimentatore remoto da ordinare separatamente.

Heavy Metal Wall 2

Apparecchio installabile a parete. Disponibile con emissione luminosa monodirezionale o bidirezionale, con differenti fasci di apertura per coprire molteplici esigenze illuminotecniche. Corpo in alluminio tornito lega EN AW 6060, piastra di fissaggio a parete in acciaio inox AISI 316L. Diffusore in vetro extra chiaro con bordo serigrafato, fissato attraverso un sistema di incollaggio robotizzato. Apparecchio in 24V dc, necessita di alimentatore remoto da ordinare separatamente.

Heavy Metal Wall 3

Apparecchio installabile a parete. Disponibile con emissione luminosa monodirezionale o bidirezionale, con fascio di apertura luminoso morbido e diffuso. Corpo in alluminio tornito lega EN AW 6060, piastra di fissaggio a parete in acciaio inox AISI 316L. Diffusore in vetro sabbato con bordo serigrafato, fissato attraverso un sistema di incollaggio robotizzato. Apparecchio in 24V dc, necessita di alimentatore remoto da ordinare separatamente. Per una installazione più agevole è disponibile la cassaforma opzionale (scatola di derivazione 3 moduli modello 503) dove poter anche alloggiare un singolo alimentatore IP 65.

Complete family of luminaires with LED light source, available in different finishes with a double layer coating and a chemical conversion surface treatment to guarantee high resistance to corrosion. The fixing screws are made of AISI 316L stainless steel.

Heavy Metal Spot

Ultra-compact, adjustable projector, designed for ground, wall or ceiling installation, and a post to be ordered separately. Available in two sizes (50x50 mm and 70x70 mm) and with different beam angles to meet different lighting requirements. Turned aluminium structure, EN AW 6060 alloy and AISI 316L stainless steel fixing bracket matching the luminaire finishes for a perfect overall look. The fixing bracket allows an orientation of 180° on the vertical axis and an orientation of less than 20° on the horizontal axis in order to direct the light beam according to requirements. Extra clear glass diffuser with silkscreen border, fixed through a robotic gluing system 24V dc luminaire powered by a remote power supply to be ordered separately.

Heavy Metal Wall 1

Wall luminaire. Available with monodirectional or bidirectional light emission and with different beam angles to meet different lighting requirements. Turned aluminium body, EN AW 6060 alloy. Stainless steel AISI 316L wall fixing plate. Extra clear glass diffuser with silkscreen border, fixed through a robotic gluing system. 24V dc luminaire powered by a remote power supply to be ordered separately.

Heavy Metal Wall 2

Wall luminaire. Available with monodirectional or bidirectional light emission and with different beam angles to meet different lighting requirements. Turned aluminium body, EN AW 6060 alloy. Stainless steel AISI 316L wall fixing plate. Extra clear glass diffuser with silkscreen border, fixed through a robotic gluing system. 24V dc luminaire powered by a remote power supply to be ordered separately.

Heavy Metal Wall 3

Wall luminaire. Available with monodirectional or bidirectional light emission and a smooth and diffuse beam angle. Turned aluminium body, EN AW 6060 alloy. Stainless steel AISI 316L wall fixing plate. Frosted glass diffuser with silkscreen border, fixed through a robotic gluing system. 24V dc luminaire powered by a remote power supply to be ordered separately. For easy installation, a 3 modules junction box (model 503), where a single IP 65 power supply can also be placed, is available as an option.

Heavy Metal Spot 1

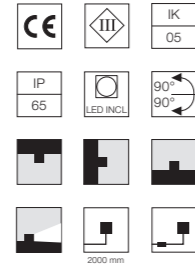
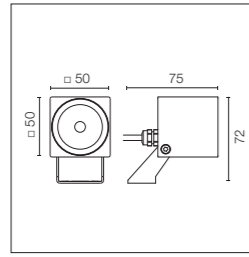

Sorgente luminosa a LED inclusa. Alimentazione elettrica remota 24V dc ON/OFF da ordinare separatamente. Staffa di fissaggio a parete inclusa. Dotato di spezzone di cavo uscente in neoprene di 250 mm e kit con connettori crimp e guaina termorestringente adesiva per connessione a tenuta stagna. Vetro trasparente extrachiario.

LED source included. Electric remote 24V dc ON/OFF power supply to be ordered separately. Wall fixing bracket included. The luminaire is equipped with a protruding, neoprene, 250 mm cable and a wiring kit with crimp connectors and adhesive heat-shrink tubing guaranteeing the water tightness of the connection. Extra clear transparent glass.

Optic Spot 10°

Power Led: 3,4W - LED 199 lm ≠ OUTPUT 138 lm - 2700K/CRI 80 - 24Vdc / 3,4W - LED 215 lm ≠ OUTPUT 149 lm - 3000K/CRI 80 - 24Vdc / 3,4W - LED 224 lm ≠ OUTPUT 155 lm - 4000K/CRI 80 - 24Vdc

- | | | |
|--------------|--------------|--------------|
| 2700K | 3000K | 4000K |
| ○ FA50900501 | ○ FA50900301 | ○ FA50900201 |
| ● FA50900506 | ● FA50900306 | ● FA50900206 |
| ● FA50900512 | ● FA50900312 | ● FA50900212 |
| ● FA50900518 | ● FA50900318 | ● FA50900218 |
| ● FA50900530 | ● FA50900330 | ● FA50900230 |
| ● FA50900533 | ● FA50900333 | ● FA50900233 |

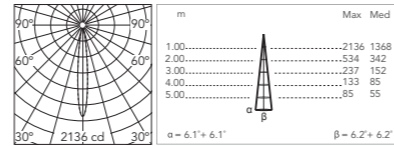

@ 3000K

Optic Medium 30°

Power Led: 3,4W - LED 199 lm ≠ OUTPUT 121 lm - 2700K/CRI 80 - 24Vdc / 3,4W - LED 215 lm ≠ OUTPUT 131 lm - 3000K/CRI 80 - 24Vdc / 3,4W - LED 224 lm ≠ OUTPUT 136 lm - 4000K/CRI 80 - 24Vdc

- | | | |
|--------------|--------------|--------------|
| 2700K | 3000K | 4000K |
| ○ FA50901501 | ○ FA50901301 | ○ FA50901201 |
| ● FA50901506 | ● FA50901306 | ● FA50901206 |
| ● FA50901512 | ● FA50901312 | ● FA50901212 |
| ● FA50901518 | ● FA50901318 | ● FA50901218 |
| ● FA50901530 | ● FA50901330 | ● FA50901230 |
| ● FA50901533 | ● FA50901333 | ● FA50901233 |

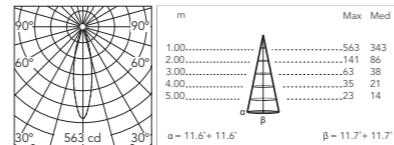

@ 3000K

* Numero massimo di apparecchi per alimentatore / Maximum number of luminaires per power supply.

Numero massimo di apparecchi per alimentatore (Vin220÷240). Dati indicativi da verificare con le specifiche condizioni di installazione.	Maximum number of luminaires per power supply. (220÷240 V). These data must be checked taking into account the specific installation conditions.	Acc. RF25754	1	Acc. RF25752	3
		Acc. RF25748	1	Acc. RF25755	9
		Acc. RF25747	2	Acc. RF25749	17
		Acc. RF25757	2		

Heavy Metal HP Spot 1

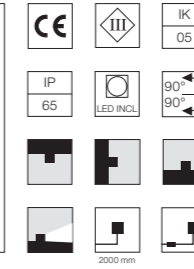
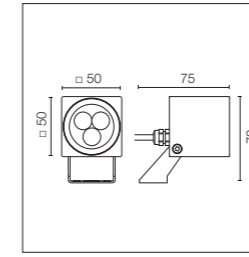

Sorgente luminosa a LED inclusa. Alimentazione elettrica remota 24V dc ON/OFF da ordinare separatamente. Staffa di fissaggio a parete inclusa. Dotato di spezzone di cavo uscente in neoprene di 250 mm e kit con connettori crimp e guaina termorestringente adesiva per connessione a tenuta stagna. Vetro trasparente extrachiario.

LED source included. Electric remote 24V dc ON/OFF power supply to be ordered separately. Wall fixing bracket included. The luminaire is equipped with a protruding, neoprene, 250 mm cable and a wiring kit with crimp connectors and adhesive heat-shrink tubing guaranteeing the water tightness of the connection. Extra clear transparent glass.

Optic Spot 10°

Power Led: 4,5W - LED 331 lm ≠ OUTPUT 246 lm - 2700K/CRI 80 - 24Vdc / 4,5W - LED 359 lm ≠ OUTPUT 267 lm - 3000K/CRI 80 - 24Vdc / 4,5W - LED 373 lm ≠ OUTPUT 277 lm - 4000K/CRI 80 - 24Vdc

- | | | |
|--------------|--------------|--------------|
| 2700K | 3000K | 4000K |
| ○ FA50902501 | ○ FA50902301 | ○ FA50902201 |
| ● FA50902506 | ● FA50902306 | ● FA50902206 |
| ● FA50902512 | ● FA50902312 | ● FA50902212 |
| ● FA50902518 | ● FA50902318 | ● FA50902218 |
| ● FA50902530 | ● FA50902330 | ● FA50902230 |
| ● FA50902533 | ● FA50902333 | ● FA50902233 |

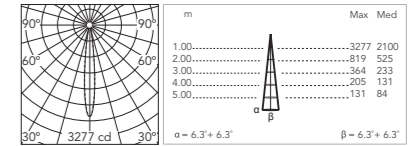

@ 3000K

Optic Medium 30°

Power Led: 4,5W - LED 331 lm ≠ OUTPUT 218 lm - 2700K/CRI 80 - 24Vdc / 4,5W - LED 359 lm ≠ OUTPUT 236 lm - 3000K/CRI 80 - 24Vdc / 4,5W - LED 373 lm ≠ OUTPUT 245 lm - 4000K/CRI 80 - 24Vdc

- | | | |
|--------------|--------------|--------------|
| 2700K | 3000K | 4000K |
| ○ FA50903501 | ○ FA50903301 | ○ FA50903201 |
| ● FA50903506 | ● FA50903306 | ● FA50903206 |
| ● FA50903512 | ● FA50903312 | ● FA50903212 |
| ● FA50903518 | ● FA50903318 | ● FA50903218 |
| ● FA50903530 | ● FA50903330 | ● FA50903230 |
| ● FA50903533 | ● FA50903333 | ● FA50903233 |

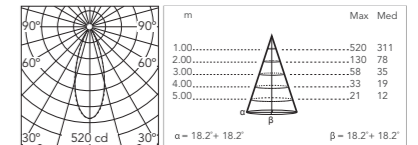

@ 3000K

* Numero massimo di apparecchi per alimentatore / Maximum number of luminaires per power supply.

Numero massimo di apparecchi per alimentatore (Vin220÷240). Dati indicativi da verificare con le specifiche condizioni di installazione.	Maximum number of luminaires per power supply. (220÷240 V). These data must be checked taking into account the specific installation conditions.	Acc. RF25754	1	Acc. RF25757	2
		Acc. RF25748	1	Acc. RF25755	7
		Acc. RF25747	2	Acc. RF25749	14

Heavy Metal Spot 2

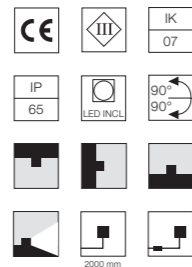
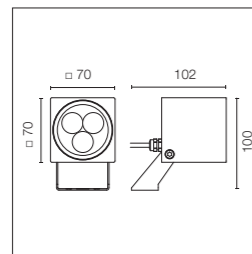

Sorgente luminosa a LED inclusa. Alimentazione elettrica remota 24V dc ON/OFF da ordinare separatamente. Staffa di fissaggio a parete inclusa. Dotato di spezzone di cavo uscente in neoprene di 250 mm e kit con connettori crimp e guaina termorestringente adesiva per connessione a tenuta stagna. Vetro trasparente extrachiario.

LED source included. Electric remote 24V dc ON/OFF power supply to be ordered separately. Wall fixing bracket included. The luminaire is equipped with a protruding, neoprene, 250 mm cable and a wiring kit with crimp connectors and adhesive heat-shrink tubing guaranteeing the water tightness of the connection. Extra clear transparent glass.

Optic Spot 10°

Power Led: 5,9W - LED 431 lm ≠ OUTPUT 359 lm - 2700K/CRI 80 - 24Vdc / 5,9W - LED 466 lm ≠ OUTPUT 389 lm - 3000K/CRI 80 - 24Vdc / 5,9W - LED 484 lm ≠ OUTPUT 404 lm - 4000K/CRI 80 - 24Vdc

- | | | |
|--------------|--------------|--------------|
| 2700K | 3000K | 4000K |
| ○ FA50904501 | ○ FA50904301 | ○ FA50904201 |
| ● FA50904506 | ● FA50904306 | ● FA50904206 |
| ● FA50904512 | ● FA50904312 | ● FA50904212 |
| ● FA50904518 | ● FA50904318 | ● FA50904218 |
| ● FA50904530 | ● FA50904330 | ● FA50904230 |
| ● FA50904533 | ● FA50904333 | ● FA50904233 |

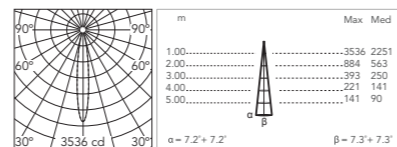

@ 3000K

Optic Medium 30°

Power Led: 5,9W - LED 431 lm ≠ OUTPUT 364 lm - 2700K/CRI 80 - 24Vdc / 5,9W - LED 466 lm ≠ OUTPUT 395 lm - 3000K/CRI 80 - 24Vdc / 5,9W - LED 484 lm ≠ OUTPUT 410 lm - 4000K/CRI 80 - 24Vdc

- | | | |
|--------------|--------------|--------------|
| 2700K | 3000K | 4000K |
| ○ FA50906501 | ○ FA50906301 | ○ FA50906201 |
| ● FA50906506 | ● FA50906306 | ● FA50906206 |
| ● FA50906512 | ● FA50906312 | ● FA50906212 |
| ● FA50906518 | ● FA50906318 | ● FA50906218 |
| ● FA50906530 | ● FA50906330 | ● FA50906230 |
| ● FA50906533 | ● FA50906333 | ● FA50906233 |

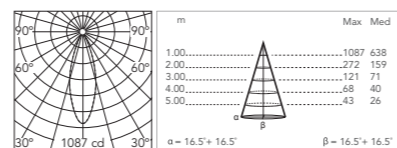

@ 3000K

Optic Flood 50°

Power Led: 5,9W - LED 431 lm ≠ OUTPUT 329 lm - 2700K/CRI 80 - 24Vdc / 5,9W - LED 466 lm ≠ OUTPUT 357 lm - 3000K/CRI 80 - 24Vdc / 5,9W - LED 484 lm ≠ OUTPUT 371 lm - 4000K/CRI 80 - 24Vdc

- | | | |
|--------------|--------------|--------------|
| 2700K | 3000K | 4000K |
| ○ FA50905501 | ○ FA50905301 | ○ FA50905201 |
| ● FA50905506 | ● FA50905306 | ● FA50905206 |
| ● FA50905512 | ● FA50905312 | ● FA50905212 |
| ● FA50905518 | ● FA50905318 | ● FA50905218 |
| ● FA50905530 | ● FA50905330 | ● FA50905230 |
| ● FA50905533 | ● FA50905333 | ● FA50905233 |

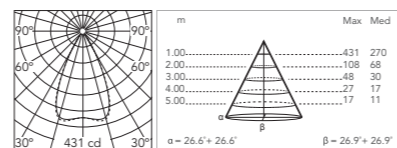

@ 3000K

* Numero massimo di apparecchi per alimentatore / Maximum number of luminaires per power supply.

Numero massimo di apparecchi per alimentatore (Vin220÷240). Dati indicativi da verificare con le specifiche condizioni di installazione.

Acc. RF25747	1	Acc. RF25755	6
Acc. RF25757	1	Acc. RF25749	12
Acc. RF25752	2		

Heavy Metal Spot: Accessori / Accessories

Picchetto per installazione a terra.

Ground spike.

FA136



Heavy Metal Spot: Driver / Drivers

Alimentatore doppia funzione Vout 24Vdc: 8W/100÷240V Iout 350ma: 6x1W/100÷240V IP20 Classe II Selv Eq.

Power supply dual function Vout 24Vdc: 8W/100÷240V Iout 350ma: 6x1W/100÷240V IP20 Class II Selv Eq.

*RF25754

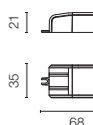

Alimentatore 24V 8W / 110-240V IP65 Classe II selv.

Power supply 24V 8W / 110-240V IP65 Class II selv.

*RF25748

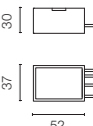

Alimentatore 24V 10W / 110-240V IP20 Classe II selv.

Power supply 24V 10W / 110-240V IP20 Class II selv.

*RF25747

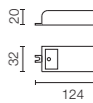

Alimentatore 24V 10W / 110-240V IP67 Classe II selv.

Power supply 24V 10W / 110-240V IP67 Class II selv.

*RF25757

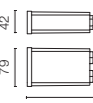

Alimentatore per installazione remota 24Vdc 20W / 220-240V IP67 Classe II selv.

Power supply for remote installation 24Vdc 20W / 220-240V IP67 Class II selv.

*RF25752

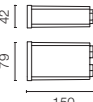

Alimentatore 24Vdc 35W / 120-270V IP67 Classe II selv.

Power supply 24Vdc 35W / 120-270V IP67 Class II selv.

F990B23AZ00

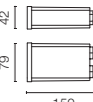

Alimentatore 24Vdc 50W / 120-240V IP67 Classe II selv.

Power supply 24Vdc 50W / 120-240V IP67 Class II selv.

*RF25755

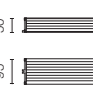

Alimentatore 24Vdc 70W / 220-240V IP67 Classe II selv.

Power supply 24Vdc 70W / 220-240V IP67 Class II selv.

*RF25749

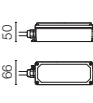

Heavy Metal Wall 1

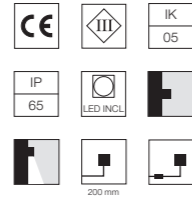
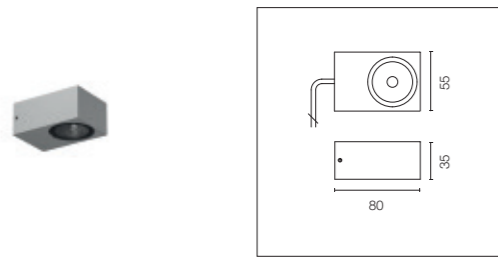

Sorgente luminosa a LED inclusa. Alimentazione elettrica remota 24V dc ON/OFF da ordinare separatamente. Staffa di fissaggio a parete inclusa. Dotato di spezzone di cavo uscente in neoprene di 250 mm e kit con connettori crimp e guaina termorestringente adesiva per connessione a tenuta stagna. Vetro trasparente extrachiario.

LED source included. Electric remote 24V dc ON/OFF power supply to be ordered separately. Wall fixing bracket included. The luminaire is equipped with a protruding, neoprene, 250 mm cable and a wiring kit with crimp connectors and adhesive heat-shrink tubing guaranteeing the water tightness of the connection. Extra clear transparent glass.

Optic Spot 10°

Power Led: 3,4W - LED 199 lm ≠ OUTPUT 138 lm - 2700K/CRI 80 - 24Vdc / 3,4W - LED 215 lm ≠ OUTPUT 149 lm - 3000K/CRI 80 - 24Vdc / 3,4W - LED 224 lm ≠ OUTPUT 155 lm - 4000K/CRI 80 - 24Vdc

- | | | |
|--------------|--------------|--------------|
| 2700K | 3000K | 4000K |
| ○ FA50800501 | ○ FA50800301 | ○ FA50800201 |
| ● FA50800506 | ● FA50800306 | ● FA50800206 |
| ● FA50800512 | ● FA50800312 | ● FA50800212 |
| ● FA50800518 | ● FA50800318 | ● FA50800218 |
| ● FA50800530 | ● FA50800330 | ● FA50800230 |
| ● FA50800533 | ● FA50800333 | ● FA50800233 |

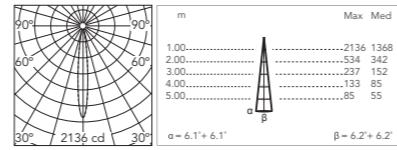

@ 3000K

Optic Medium 30°

Power Led: 3,4W - LED 199 lm ≠ OUTPUT 121 lm - 2700K/CRI 80 - 24Vdc / 3,4W - LED 215 lm ≠ OUTPUT 131 lm - 3000K/CRI 80 - 24Vdc / 3,4W - LED 224 lm ≠ OUTPUT 136 lm - 4000K/CRI 80 - 24Vdc

- | | | |
|--------------|--------------|--------------|
| 2700K | 3000K | 4000K |
| ○ FA50801501 | ○ FA50801301 | ○ FA50801201 |
| ● FA50801506 | ● FA50801306 | ● FA50801206 |
| ● FA50801512 | ● FA50801312 | ● FA50801212 |
| ● FA50801518 | ● FA50801318 | ● FA50801218 |
| ● FA50801530 | ● FA50801330 | ● FA50801230 |
| ● FA50801533 | ● FA50801333 | ● FA50801233 |

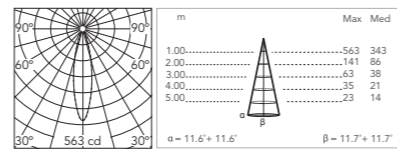

@ 3000K

* Numero massimo di apparecchi per alimentatore / Maximum number of luminaires per power supply.

Numero massimo di apparecchi per alimentatore (Vin220÷240). Dati indicativi da verificare con le specifiche condizioni di installazione.	Maximum number of luminaires per power supply. (220÷240 V). These data must be checked taking into account the specific installation conditions.	Acc. RF25754	1	Acc. RF25752	3
		Acc. RF25748	1	Acc. RF25755	9
		Acc. RF25747	2	Acc. RF25749	17
		Acc. RF25757	2		

Heavy Metal HP Wall 1

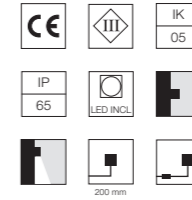
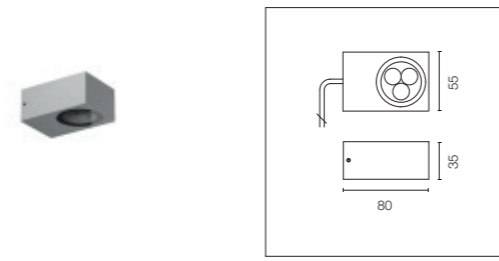

Sorgente luminosa a LED inclusa. Alimentazione elettrica remota 24V dc ON/OFF da ordinare separatamente. Staffa di fissaggio a parete inclusa. Dotato di spezzone di cavo uscente in neoprene di 250 mm e kit con connettori crimp e guaina termorestringente adesiva per connessione a tenuta stagna. Vetro trasparente extrachiario.

LED source included. Electric remote 24V dc ON/OFF power supply to be ordered separately. Wall fixing bracket included. The luminaire is equipped with a protruding, neoprene, 250 mm cable and a wiring kit with crimp connectors and adhesive heat-shrink tubing guaranteeing the water tightness of the connection. Extra clear transparent glass.

Optic Spot 10°

Power Led: 4,5W - LED 331 lm ≠ OUTPUT 246 lm - 2700K/CRI 80 - 24Vdc / 4,5W - LED 359 lm ≠ OUTPUT 267 lm - 3000K/CRI 80 - 24Vdc / 4,5W - LED 373 lm ≠ OUTPUT 277 lm - 4000K/CRI 80 - 24Vdc

- | | | |
|--------------|--------------|--------------|
| 2700K | 3000K | 4000K |
| ○ FA50802501 | ○ FA50802301 | ○ FA50802201 |
| ● FA50802506 | ● FA50802306 | ● FA50802206 |
| ● FA50802512 | ● FA50802312 | ● FA50802212 |
| ● FA50802518 | ● FA50802318 | ● FA50802218 |
| ● FA50802530 | ● FA50802330 | ● FA50802230 |
| ● FA50802533 | ● FA50802333 | ● FA50802233 |

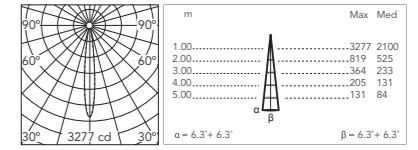

@ 3000K

Optic Medium 30°

Power Led: 4,5W - LED 331 lm ≠ OUTPUT 218 lm - 2700K/CRI 80 - 24Vdc / 4,5W - LED 359 lm ≠ OUTPUT 236 lm - 3000K/CRI 80 - 24Vdc / 4,5W - LED 373 lm ≠ OUTPUT 245 lm - 4000K/CRI 80 - 24Vdc

- | | | |
|--------------|--------------|--------------|
| 2700K | 3000K | 4000K |
| ○ FA50803501 | ○ FA50803301 | ○ FA50803201 |
| ● FA50803506 | ● FA50803306 | ● FA50803206 |
| ● FA50803512 | ● FA50803312 | ● FA50803212 |
| ● FA50803518 | ● FA50803318 | ● FA50803218 |
| ● FA50803530 | ● FA50803330 | ● FA50803230 |
| ● FA50803533 | ● FA50803333 | ● FA50803233 |

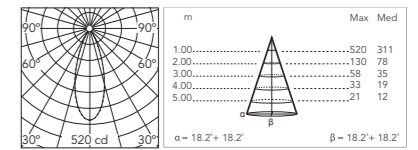









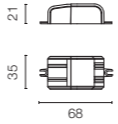

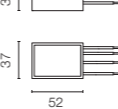

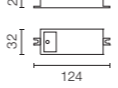

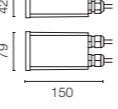
@ 3000K

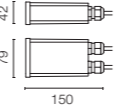
* Numero massimo di apparecchi per alimentatore / Maximum number of luminaires per power supply.

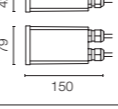
Numero massimo di apparecchi per alimentatore (Vin220÷240). Dati indicativi da verificare con le specifiche condizioni di installazione.	Maximum number of luminaires per power supply. (220÷240 V). These data must be checked taking into account the specific installation conditions.	Acc. RF25754	1	Acc. RF25757	2
		Acc. RF25748 <td>1</td> <td>Acc. RF25755 <td>7</td> </td>	1	Acc. RF25755 <td>7</td>	7
		Acc. RF25747 <td>2</td> <td>Acc. RF25749 <td>14</td> </td>	2	Acc. RF25749 <td>14</td>	14

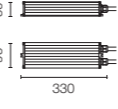
Heavy Metal Wall 1: Driver / Drivers

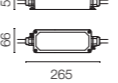
Alimentatore doppia funzione Vout 24Vdc: 8W/100÷240V Iout 350ma: 6x1W/100÷240V IP20 Classe II Selv Eq.	Power supply dual function Vout 24Vdc: 8W/100÷240V Iout 350ma: 6x1W/100÷240V IP20 Class II Selv Eq.	*RF25754		
Alimentatore 24V 8W / 110-240V IP65 Classe II selv.	Power supply 24V 8W / 110-240V IP65 Class II selv.	*RF25748		
Alimentatore 24V 10W / 110-240V IP20 Classe II selv.	Power supply 24V 10W / 110-240V IP20 Class II selv.	*RF25747		
Alimentatore 24V 10W / 110-240V IP67 Classe II selv.	Power supply 24V 10W / 110-240V IP67 Class II selv.	*RF25757		
Alimentatore per installazione remota 24Vdc 20W / 220-240V IP67 Classe II selv.	Power supply for remote installation 24Vdc 20W / 220-240V IP67 Class II selv.	Heavy Metal Wall 1 2,2W *RF25752		
Alimentatore 24Vdc 35W / 120-270V IP67 Classe II selv.	Power supply 24Vdc 35W / 120-270V IP67 Class II selv.	F990B23AZ00		
Alimentatore 24Vdc 50W / 120-240V IP67 Classe II selv.	Power supply 24Vdc 50W / 120-240V IP67 Class II selv.	*RF25755		
Alimentatore 24Vdc 70W / 220-240V IP67 Classe II selv.	Power supply 24Vdc 70W / 220-240V IP67 Class II selv.	*RF25749		

Heavy Metal Wall 2 Mono













Sorgente luminosa a LED inclusa. Alimentazione elettrica remota 24V dc ON/OFF da ordinare separatamente. Staffa di fissaggio a parete inclusa. Dotato di spezzone di cavo uscente in neoprene di 250 mm e kit con connettori crimp e guaina termorestringente adesiva per connessione a tenuta stagna. Vetro trasparente extrachiaro.

LED source included. Electric remote 24V dc ON/OFF power supply to be ordered separately. Wall fixing bracket included. The luminaire is equipped with a protruding, neoprene, 250 mm cable and a wiring kit with crimp connectors and adhesive heat-shrink tubing guaranteeing the water tightness of the connection. Extra clear transparent glass.

Optic Spot 10°

Power Led: 3,4W - LED 199 lm ≠ OUTPUT 138 lm - 2700K/CRI 80 - 24Vdc / 3,4W - LED 215 lm ≠ OUTPUT 149 lm - 3000K/CRI 80 - 24Vdc / 3,4W - LED 224 lm ≠ OUTPUT 155 lm - 4000K/CRI 80 - 24Vdc

2700K

- FA50700501
- FA50700506
- FA50700512
- FA50700518
- FA50700530
- FA50700533

3000K

- FA50700301
- FA50700306
- FA50700312
- FA50700318
- FA50700330
- FA50700333

4000K

- FA50700201
- FA50700206
- FA50700212
- FA50700218
- FA50700230
- FA50700233

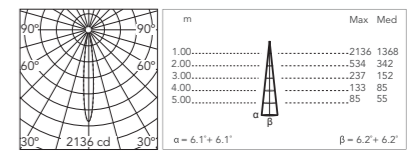

@ 3000K

Optic Medium 30°

Power Led: 3,4W - LED 199 lm ≠ OUTPUT 121 lm - 2700K/CRI 80 - 24Vdc / 3,4W - LED 215 lm ≠ OUTPUT 131 lm - 3000K/CRI 80 - 24Vdc / 3,4W - LED 224 lm ≠ OUTPUT 136 lm - 4000K/CRI 80 - 24Vdc

2700K

- FA50701501
- FA50701506
- FA50701512
- FA50701518
- FA50701530
- FA50701533

3000K

- FA50701301
- FA50701306
- FA50701312
- FA50701318
- FA50701330
- FA50701333

4000K

- FA50701201
- FA50701206
- FA50701212
- FA50701218
- FA50701230
- FA50701233

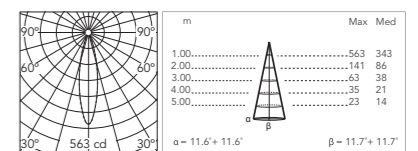

@ 3000K

* Numero massimo di apparecchi per alimentatore / Maximum number of luminaires per power supply.

Numero massimo di apparecchi per alimentatore (Vin220÷240). Dati indicativi da verificare con le specifiche condizioni di installazione.	Maximum number of luminaires per power supply. (220÷240 V). These data must be checked taking into account the specific installation conditions.	Acc. RF25754	1	Acc. RF25752	3
		Acc. RF25748	1	Acc. RF25755	9
		Acc. RF25747	2	Acc. RF25749	17
		Acc. RF25757	2		

Heavy Metal HP Wall 2 Mono

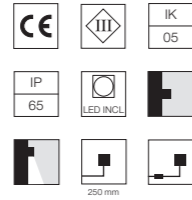
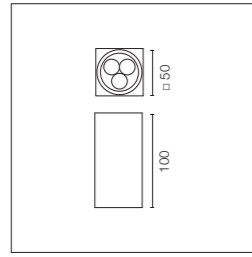

Sorgente luminosa a LED inclusa. Alimentazione elettrica remota 24V dc ON/OFF da ordinare separatamente. Staffa di fissaggio a parete inclusa. Dotato di spezzone di cavo uscente in neoprene di 250 mm e kit con connettori crimp e guaina termorestringente adesiva per connessione a tenuta stagna. Vetro trasparente extrachiario.

LED source included. Electric remote 24V dc ON/OFF power supply to be ordered separately. Wall fixing bracket included. The luminaire is equipped with a protruding, neoprene, 250 mm cable and a wiring kit with crimp connectors and adhesive heat-shrink tubing guaranteeing the water tightness of the connection. Extra clear transparent glass.

Optic Spot 10°

Power Led: 4,5W - LED 331 lm ≠ OUTPUT 246 lm - 2700K/CRI 80 - 24Vdc / 4,5W - LED 359 lm ≠ OUTPUT 267 lm - 3000K/CRI 80 - 24Vdc / 4,5W - LED 373 lm ≠ OUTPUT 277 lm - 4000K/CRI 80 - 24Vdc

- | | | |
|--------------|--------------|--------------|
| 2700K | 3000K | 4000K |
| ○ FA50702501 | ○ FA50702301 | ○ FA50702201 |
| ● FA50702506 | ● FA50702306 | ● FA50702206 |
| ● FA50702512 | ● FA50702312 | ● FA50702212 |
| ● FA50702518 | ● FA50702318 | ● FA50702218 |
| ● FA50702530 | ● FA50702330 | ● FA50702230 |
| ● FA50702533 | ● FA50702333 | ● FA50702233 |

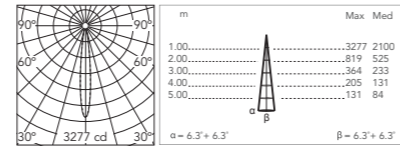

@ 3000K

Optic Medium 30°

Power Led: 4,5W - LED 331 lm ≠ OUTPUT 218 lm - 2700K/CRI 80 - 24Vdc / 4,5W - LED 359 lm ≠ OUTPUT 236 lm - 3000K/CRI 80 - 24Vdc / 4,5W - LED 373 lm ≠ OUTPUT 245 lm - 4000K/CRI 80 - 24Vdc

- | | | |
|--------------|--------------|--------------|
| 2700K | 3000K | 4000K |
| ○ FA50703501 | ○ FA50703301 | ○ FA50703201 |
| ● FA50703506 | ● FA50703306 | ● FA50703206 |
| ● FA50703512 | ● FA50703312 | ● FA50703212 |
| ● FA50703518 | ● FA50703318 | ● FA50703218 |
| ● FA50703530 | ● FA50703330 | ● FA50703230 |
| ● FA50703533 | ● FA50703333 | ● FA50703233 |

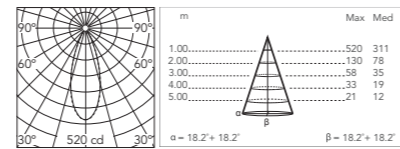

@ 3000K

* Numero massimo di apparecchi per alimentatore / Maximum number of luminaires per power supply.

Numero massimo di apparecchi per alimentatore (Vin220÷240). Dati indicativi da verificare con le specifiche condizioni di installazione.	Maximum number of luminaires per power supply. (220÷240 V). These data must be checked taking into account the specific installation conditions.	Acc. RF25754	1	Acc. RF25757	2
		Acc. RF25748	1	Acc. RF25755	7
		Acc. RF25747	2	Acc. RF25749	14

Heavy Metal Wall 2 Double

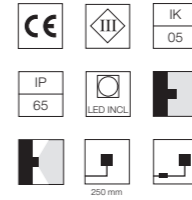
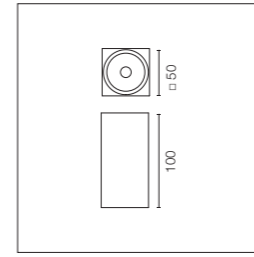

Sorgente luminosa a LED inclusa. Alimentazione elettrica remota 24V dc ON/OFF da ordinare separatamente. Staffa di fissaggio a parete inclusa. Dotato di spezzone di cavo uscente in neoprene di 250 mm e kit con connettori crimp e guaina termorestringente adesiva per connessione a tenuta stagna. Vetro trasparente extrachiario.

LED source included. Electric remote 24V dc ON/OFF power supply to be ordered separately. Wall fixing bracket included. The luminaire is equipped with a protruding, neoprene, 250 mm cable and a wiring kit with crimp connectors and adhesive heat-shrink tubing guaranteeing the water tightness of the connection. Extra clear transparent glass.

Optic Spot 10°

Power Led: 6,8W - LED 2x199 lm ≠ OUTPUT 2x138 lm - 2700K/CRI 80 - 24Vdc / 6,8W - LED 2x215 lm ≠ OUTPUT 2x149 lm - 3000K/CRI 80 - 24Vdc / 6,8W - LED 2x224 lm ≠ OUTPUT 2x155 lm - 4000K/CRI 80 - 24Vdc

- | | | |
|--------------|--------------|--------------|
| 2700K | 3000K | 4000K |
| ○ FA50710501 | ○ FA50710301 | ○ FA50710201 |
| ● FA50710506 | ● FA50710306 | ● FA50710206 |
| ● FA50710512 | ● FA50710312 | ● FA50710212 |
| ● FA50710518 | ● FA50710318 | ● FA50710218 |
| ● FA50710530 | ● FA50710330 | ● FA50710230 |
| ● FA50710533 | ● FA50710333 | ● FA50710233 |

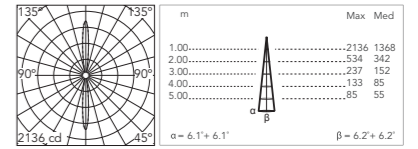

@ 3000K

Optic Medium 30°

Power Led: 6,8W - LED 2x199 lm ≠ OUTPUT 2x121 lm - 2700K/CRI 80 - 24Vdc / 6,8W - LED 2x215 lm ≠ OUTPUT 2x131 lm - 3000K/CRI 80 - 24Vdc / 6,8W - LED 2x224 lm ≠ OUTPUT 2x136 lm - 4000K/CRI 80 - 24Vdc

- | | | |
|--------------|--------------|--------------|
| 2700K | 3000K | 4000K |
| ○ FA50711501 | ○ FA50711301 | ○ FA50711201 |
| ● FA50711506 | ● FA50711306 | ● FA50711206 |
| ● FA50711512 | ● FA50711312 | ● FA50711212 |
| ● FA50711518 | ● FA50711318 | ● FA50711218 |
| ● FA50711530 | ● FA50711330 | ● FA50711230 |
| ● FA50711533 | ● FA50711333 | ● FA50711233 |

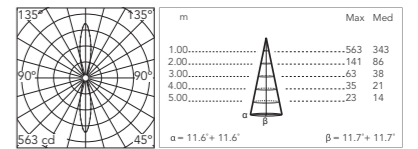

@ 3000K

* Numero massimo di apparecchi per alimentatore / Maximum number of luminaires per power supply.

Numero massimo di apparecchi per alimentatore (Vin220÷240). Dati indicativi da verificare con le specifiche condizioni di installazione.	Maximum number of luminaires per power supply. (220÷240 V). These data must be checked taking into account the specific installation conditions.	Acc. RF25747	1	Acc. RF25755	5
		Acc. RF25757	1	Acc. RF25749	8
		Acc. RF25752	2		

Heavy Metal HP Wall 2 Double

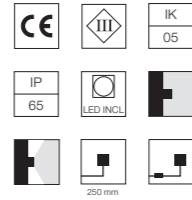
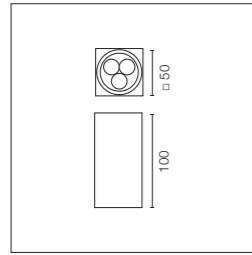

Sorgente luminosa a LED inclusa. Alimentazione elettrica remota 24V dc ON/OFF da ordinare separatamente. Staffa di fissaggio a parete inclusa. Dotato di spezzone di cavo uscente in neoprene di 250 mm e kit con connettori crimp e guaina termorestringente adesiva per connessione a tenuta stagna. Vetro trasparente extrachiaro.

LED source included. Electric remote 24V dc ON/OFF power supply to be ordered separately. Wall fixing bracket included. The luminaire is equipped with a protruding, neoprene, 250 mm cable and a wiring kit with crimp connectors and adhesive heat-shrink tubing guaranteeing the water tightness of the connection. Extra clear transparent glass.

Optic Spot 10°

Power Led: 9W - LED 2x331 lm ≠ OUTPUT 2x246 lm - 2700K/CRI 80 - 24Vdc / 9W - LED 2x359 lm ≠ OUTPUT 2x267 lm - 3000K/CRI 80 - 24Vdc / 9W - LED 2x373 lm ≠ OUTPUT 2x277 lm - 4000K/CRI 80 - 24Vdc

2700K

- FA50712501
- FA50712506
- FA50712512
- FA50712518
- FA50712530
- FA50712533

3000K

- FA50712301
- FA50712306
- FA50712312
- FA50712318
- FA50712330
- FA50712333

4000K

- FA50712201
- FA50712206
- FA50712212
- FA50712218
- FA50712230
- FA50712233

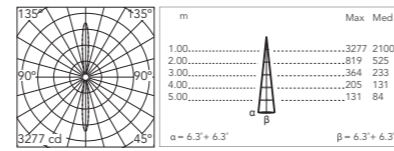

@ 3000K

Optic Medium 30°

Power Led: 9W - LED 2x331 lm ≠ OUTPUT 2x218 lm - 2700K/CRI 80 - 24Vdc / 9W - LED 2x359 lm ≠ OUTPUT 2x236 lm - 3000K/CRI 80 - 24Vdc / 9W - LED 2x373 lm ≠ OUTPUT 2x245 lm - 4000K/CRI 80 - 24Vdc

2700K

- FA50713501
- FA50713506
- FA50713512
- FA50713518
- FA50713530
- FA50713533

3000K

- FA50713301
- FA50713306
- FA50713312
- FA50713318
- FA50713330
- FA50713333

4000K

- FA50713201
- FA50713206
- FA50713212
- FA50713218
- FA50713230
- FA50713233

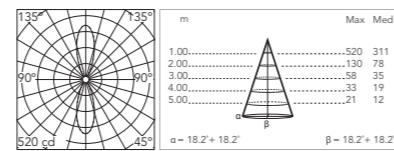

@ 3000K

* Numero massimo di apparecchi per alimentatore / Maximum number of luminaires per power supply.

Numero massimo di apparecchi per alimentatore (Vin220-240). Dati indicativi da verificare con le specifiche condizioni di installazione.	Maximum number of luminaires per power supply. (220-240 V). These data must be checked taking into account the specific installation conditions.	Acc.	RF25747	1
		Acc.	RF25757	1
		Acc.	RF25755	3
		Acc.	RF25749	7

Heavy Metal Wall 2: Driver / Drivers

Alimentatore doppia funzione Vout 24Vdc: 8W/100±240V Iout 350ma: 6x1W/100±240V IP20 Classe II Selv Eq.

Power supply dual function Vout 24Vdc: 8W/100±240V Iout 350ma: 6x1W/100±240V IP20 Class II Selv Eq.

Heavy Metal Wall 2 Mono
*RF25754

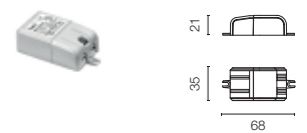

Alimentatore 24V 8W / 110-240V IP65 Classe II selv.

Power supply 24V 8W / 110-240V IP65 Class II selv.

Heavy Metal Wall 2 Double
*RF25748

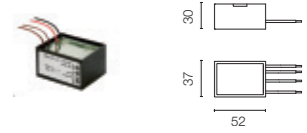

Alimentatore 24V 10W / 110-240V IP20 Classe II selv.

Power supply 24V 10W / 110-240V IP20 Class II selv.

*RF25747



Alimentatore 24V 10W / 110-240V IP67 Classe II selv.

Power supply 24V 10W / 110-240V IP67 Class II selv.

*RF25757



Alimentatore per installazione remota 24Vdc 20W / 220-240V IP67 Classe II selv.

Power supply for remote installation 24Vdc 20W / 220-240V IP67 Class II selv.

*RF25752

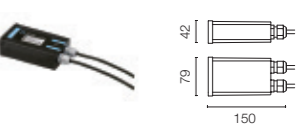

Alimentatore 24Vdc 35W / 120-270V IP67 Classe II selv.

Power supply 24Vdc 35W / 120-270V IP67 Class II selv.

F990B23AZ00

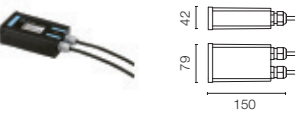

Alimentatore 24Vdc 50W / 120-240V IP67 Classe II selv.

Power supply 24Vdc 50W / 120-240V IP67 Class II selv.

*RF25755



Alimentatore 24Vdc 70W / 220-240V IP67 Classe II selv.

Power supply 24Vdc 70W / 220-240V IP67 Class II selv.

*RF25749

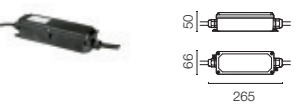

Heavy Metal Wall 3 Mono

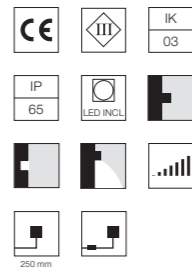
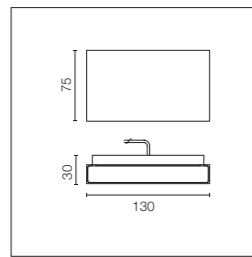

Sorgente luminosa a LED inclusa. Alimentazione elettrica remota 24V dc ON/OFF da ordinare separatamente. Staffa di fissaggio a parete inclusa. Dotato di spezzone di cavo uscente in neoprene di 250 mm e kit con connettori crimp e guaina termorestringente adesiva per connessione a tenuta stagna. Vetro trasparente extrachiaro.

LED source included. Electric remote 24V dc ON/OFF power supply to be ordered separately. Wall fixing bracket included. The luminaire is equipped with a protruding, neoprene, 250 mm cable and a wiring kit with crimp connectors and adhesive heat-shrink tubing guaranteeing the water tightness of the connection. Extra clear transparent glass.

Mid-Power Led: 2,5W - LED 246 lm ≠ OUTPUT 162 lm - 2700K/CRI 80 - 24Vdc / 2,5W - LED 265 lm ≠ OUTPUT 168 lm - 3000K/CRI 80 - 24Vdc / 2,5W - LED 278 lm ≠ OUTPUT 174 lm - 4000K/CRI 80 - 24Vdc

- | | | |
|--------------|--------------|--------------|
| 2700K | 3000K | 4000K |
| ○ FA51200501 | ○ FA51200301 | ○ FA51200201 |
| ● FA51200506 | ● FA51200306 | ● FA51200206 |
| ● FA51200512 | ● FA51200312 | ● FA51200212 |
| ● FA51200518 | ● FA51200318 | ● FA51200218 |
| ● FA51200530 | ● FA51200330 | ● FA51200230 |
| ● FA51200533 | ● FA51200333 | ● FA51200233 |

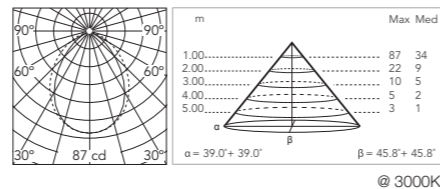

* Numero massimo di apparecchi per alimentatore / Maximum number of luminaires per power supply.

Numero massimo di apparecchi per alimentatore (Vin220÷240). Dati indicativi da verificare con le specifiche condizioni di installazione.	Maximum number of luminaires per power supply. (220÷240 V). These data must be checked taking into account the specific installation conditions.	Acc. RF25754	3	Acc. RF26387	6
		Acc. RF25748	3	Acc. RF25752	8
		Acc. RF25747	4	Acc. RF25755	20
		Acc. RF25757	4	Acc. RF25749	25
		Acc. RF25750	6	Acc. RF25756	35
		Acc. F990B21A000	6		

Heavy Metal Wall 3 Double

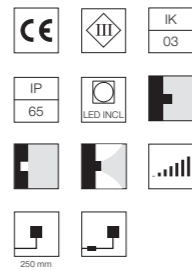
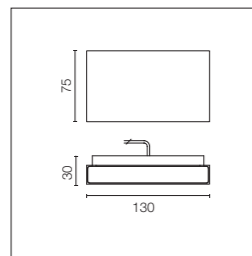

Sorgente luminosa a LED inclusa. Alimentazione elettrica remota 24V dc ON/OFF da ordinare separatamente. Staffa di fissaggio a parete inclusa. Dotato di spezzone di cavo uscente in neoprene di 250 mm e kit con connettori crimp e guaina termorestringente adesiva per connessione a tenuta stagna. Vetro trasparente extrachiaro.

LED source included. Electric remote 24V dc ON/OFF power supply to be ordered separately. Wall fixing bracket included. The luminaire is equipped with a protruding, neoprene, 250 mm cable and a wiring kit with crimp connectors and adhesive heat-shrink tubing guaranteeing the water tightness of the connection. Extra clear transparent glass.

Mid-Power Led: 5W - LED 2x246 lm ≠ OUTPUT 2x162 lm - 2700K/CRI 80 - 24Vdc / 5W - LED 2x265 lm ≠ OUTPUT 2x168 lm - 3000K/CRI 80 - 24Vdc / 5W - LED 2x278 lm ≠ OUTPUT 2x174 lm - 4000K/CRI 80 - 24Vdc

- | | | |
|--------------|--------------|--------------|
| 2700K | 3000K | 4000K |
| ○ FA51201501 | ○ FA51201301 | ○ FA51201201 |
| ● FA51201506 | ● FA51201306 | ● FA51201206 |
| ● FA51201512 | ● FA51201312 | ● FA51201212 |
| ● FA51201518 | ● FA51201318 | ● FA51201218 |
| ● FA51201530 | ● FA51201330 | ● FA51201230 |
| ● FA51201533 | ● FA51201333 | ● FA51201233 |

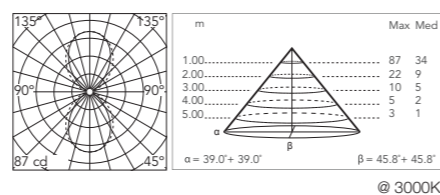

* Numero massimo di apparecchi per alimentatore / Maximum number of luminaires per power supply.

Numero massimo di apparecchi per alimentatore (Vin220÷240). Dati indicativi da verificare con le specifiche condizioni di installazione.	Maximum number of luminaires per power supply. (220÷240 V). These data must be checked taking into account the specific installation conditions.	Acc. RF25754	1	Acc. RF26387	3
		Acc. RF25748	1	Acc. RF25752	4
		Acc. RF25747	2	Acc. RF25755	10
		Acc. RF25757	2	Acc. RF25749	13
		Acc. RF25750	3	Acc. RF25756	17
		Acc. F990B21A000	3		

Heavy Metal Wall 3: Accessori / Accessories

Scatola di derivazione da incasso 3 moduli (modello 503)

Recessed 3-module junction box (model 503)

Heavy Metal Wall 3
F990H010000



Heavy Metal Wall 3 Installation acc. F990H010000

Heavy Metal Wall 3 con scatola per incasso.
Opzionale: alimentatore art. 106 in scatola da incasso.

Heavy Metal Wall 3 with box.
Optional: power supply code 106 in recessed box.

Heavy Metal Wall 3 Installation acc. F990H010000

Heavy Metal Wall 3 senza scatola per incasso.

Heavy Metal Wall 3 without box.

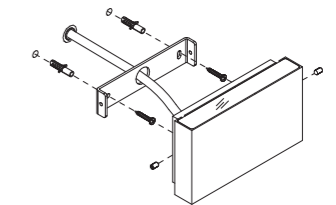
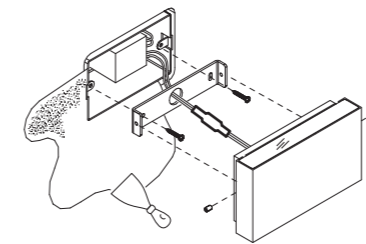

Heavy Metal Wall 3: Driver / Drivers

Alimentatore doppia funzione
Vout 24Vdc: 8W/100÷240V
Iout 350ma: 6x1W/100÷240V
IP20 Classe II Selv Eq.

Power supply dual function
Vout 24Vdc: 8W/100÷240V
Iout 350ma: 6x1W/100÷240V
IP20 Class II Selv Eq.

*RF25754

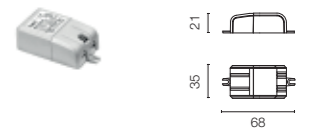

Alimentatore 24Vdc 8W / 110-240V IP65 Classe II selv.

Power supply 24Vdc 8W / 110-240V IP65 Class II selv.

*RF25748

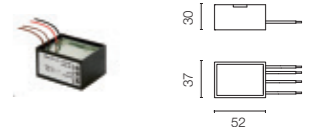

Alimentatore per installazione remota 24Vdc 10W / 110-240V IP20 Classe II selv.

Power supply for remote installation 24Vdc 10W / 110-240V IP20 Class II selv.

*RF25747



Alimentatore 24V 10W / 110-240V IP67 Classe II selv.

Power supply 24V 10W / 110-240V IP67 Class II selv.

*RF25757

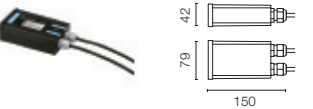

Alimentatore per installazione remota 24Vdc 17W / 110-240V (15W@110V) IP20 Classe II selv.

Power supply for remote installation 24Vdc 17W / 110-240V (15W@110V) IP20 Class II selv.

*RF25750

Dimmable 1-10V



Alimentatore 17W/110÷240V - 24Vdc (15W@110V) IP67 Classe II Selv.

Power supply 17W/110÷240V - 24Vdc (15W@110V) IP67 Class II Selv.

*F990B21A000

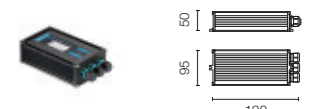

Alimentatore per installazione remota 24Vdc 20W / 110-240Vdc (15W@110V) IP67 Classe II selv.

Power supply for remote installation 24Vdc 20W / 110-240Vdc (15W@110V) IP67 Class II selv.

*RF26387

Dimmable 1-10V

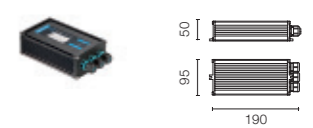

Heavy Metal Wall 3: Driver / Drivers

Alimentatore per installazione remota 24Vdc 20W / 220-240V IP67 Classe II selv.

Power supply for remote installation 24Vdc 20W / 220-240V IP67 Class II selv.

*RF25752

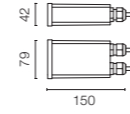

Alimentatore per installazione remota 24Vdc 50W / 120-240V IP67 Classe II selv.

Power supply for remote installation 24Vdc 50W / 120-240V IP67 Class II selv.

*RF25755

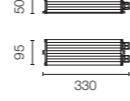

Alimentatore 24Vdc 35W / 120-270V IP67 Classe II selv.

Power supply 24Vdc 35W / 120-270V IP67 Class II selv.

F990B23AZ00

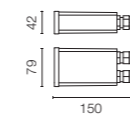

Alimentatore per installazione remota 24Vdc 70W / 220-240V IP67 Classe II selv.

Power supply for remote installation 24Vdc 70W / 220-240V IP67 Class II selv.

*RF25749

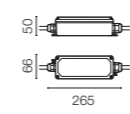

Alimentatore per installazione remota 24Vdc 96W / 120-240V IP67 Classe II selv.

Power supply for remote installation 24Vdc 96W / 120-240V IP67 Class II selv.

*RF25756

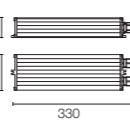

Marco





Marco Mono



Marco Double

Famiglia / Family

Marco Mono



Power Led

up to 3W
up to 103 lm - 2700K/CRI 80
up to 110 lm - 3000K/CRI 80
up to 114 lm - 4000K/CRI 80
* Net lumen output

Marco Double



Power Led

up to 4W
up to 2x103 lm - 2700K/CRI 80
up to 2x110 lm - 3000K/CRI 80
up to 2x114 lm - 4000K/CRI 80
* Net lumen output

Marco Omnidirectional



Power Led

up to 7W
up to 4x103 lm - 2700K/CRI 80
up to 4x110 lm - 3000K/CRI 80
up to 4x114 lm - 4000K/CRI 80
* Net lumen output

Descrizione / Description

Apparecchio a parete per esterno con sorgente luminosa a LED, caratterizzato dalla forma quadrata arrotondata e dalla minima sporgenza. Disponibile in differenti combinazioni di apertura di fascio e di finestre di emissione per la creazione di segni grafici a parete con luce radente. Corpo in alluminio pressofuso EN AB-47100, a basso contenuto di rame, staffa di fissaggio a parete in acciaio inox AISI 304. Diffusore in vetro extrachiario con bordo serigrafato, fissato attraverso un sistema di incollaggio robotizzato a filo con il bordo lampada per evitare depositi d'acqua. Disponibili in differenti finiture con rivestimento a doppio strato di polveri e sottoposte a trattamento di conversione chimica superficiale per una elevata resistenza alla corrosione. Viterie di fissaggio sono in acciaio inox AISI 316L di dimensioni minime per una perfetta integrazione a filo nel corpo dell'apparecchio.

Outdoor wall luminaire with LED light source. It is characterized by its square shape with rounded profiles and reduced protrusion. Available in different combinations of beam angles and emission windows, which allow the creation of luminous graphic signs flush with the wall. Die-cast aluminium structure, EN AB-47100 alloy (with low copper content) and AISI 304 stainless steel fixing bracket. Extra clear glass diffuser with silkscreen border, fixed flush with the luminaire's edge through a robotic gluing system in order to prevent water deposits. Available in different finishes with a double layer coating and a chemical conversion surface treatment to guarantee high resistance to corrosion. The fixing screws are made of AISI 316L stainless steel and of minimal dimensions for a perfect, grazing integration into the luminaire's structure.

Colori / Colours

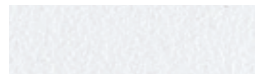

01 White



06 Grey



12 Forest Green



18 Deep Brown



30 Black



33 Anthracite

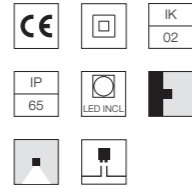
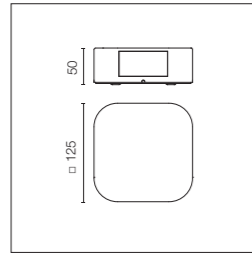

Sorgente luminosa a LED inclusa. Alimentazione elettrica 220-240V ON/ OFF integrata. Staffa di fissaggio a parete inclusa. Dotato di due pressacavi in gomma per cavi 5mmϕ<math><9\text{mm}</math> per consentire una facile connessione entrata-esci.

LED source included. Integrated electric power supply 220-240V ON/OFF. Wall fixing bracket included. Equipped with two rubber cable guides (5mmϕ<math><9\text{mm}</math>) that facilitate the inlet-outlet connection.

Optic Spot 10°

Power Led: 3W - LED 139 lm \neq OUTPUT 103 lm - 2700K/CRI 80 - 100 \pm 240V / 3W - LED 149 lm \neq OUTPUT 110 lm - 3000K/CRI 80 - 100 \pm 240V / 3W - LED 154 lm \neq OUTPUT 114 lm - 4000K/CRI 80 - 100 \pm 240V

- | | | |
|----------------|----------------|----------------|
| 2700K | 3000K | 4000K |
| ○ FA1072764301 | ○ FA1071164301 | ○ FA1072304301 |
| ● FA1072764306 | ● FA1071164306 | ● FA1072304306 |
| ● FA1072764312 | ● FA1071164312 | ● FA1072304312 |
| ● FA1072764318 | ● FA1071164318 | ● FA1072304318 |
| ● FA1072764330 | ● FA1071164330 | ● FA1072304330 |
| ● FA1072764333 | ● FA1071164333 | ● FA1072304333 |

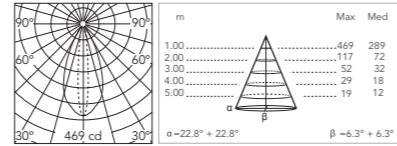

Optic Flood 75°

Power Led: 3W - LED 139 lm \neq OUTPUT 101 lm - 2700K/CRI 80 - 100 \pm 240V / 3W - LED 149 lm \neq OUTPUT 108 lm - 3000K/CRI 80 - 100 \pm 240V / 3W - LED 154 lm \neq OUTPUT 111 lm - 4000K/CRI 80 - 100 \pm 240V

- | | | |
|----------------|----------------|----------------|
| 2700K | 3000K | 4000K |
| ○ FA1072765001 | ○ FA1071165001 | ○ FA1072305001 |
| ● FA1072765006 | ● FA1071165006 | ● FA1072305006 |
| ● FA1072765012 | ● FA1071165012 | ● FA1072305012 |
| ● FA1072765018 | ● FA1071165018 | ● FA1072305018 |
| ● FA1072765030 | ● FA1071165030 | ● FA1072305030 |
| ● FA1072765033 | ● FA1071165033 | ● FA1072305033 |

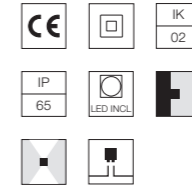
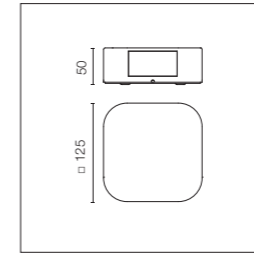
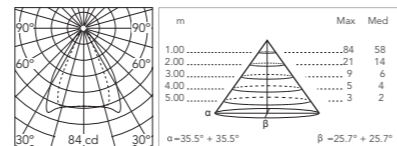

Sorgente luminosa a LED inclusa. Alimentazione elettrica 220-240V ON/ OFF integrata. Staffa di fissaggio a parete inclusa. Dotato di due pressacavi in gomma per cavi 5mmϕ<math><9\text{mm}</math> per consentire una facile connessione entrata-esci.

LED source included. Integrated electric power supply 220-240V ON/OFF. Wall fixing bracket included. Equipped with two rubber cable guides (5mmϕ<math><9\text{mm}</math>) that facilitate the inlet-outlet connection.

Optic Spot 10°

Power Led: 4W - LED 2x139 lm \neq OUTPUT 2x103 lm - 2700K/CRI 80 - 100 \pm 240V / 4W - LED 2x149 lm \neq OUTPUT 2x110 lm - 3000K/CRI 80 - 100 \pm 240V / 4W - LED 2x154 lm \neq OUTPUT 2x114 lm - 4000K/CRI 80 - 100 \pm 240V

- | | | |
|----------------|----------------|----------------|
| 2700K | 3000K | 4000K |
| ○ FA1072794401 | ○ FA1071194401 | ○ FA1072314401 |
| ● FA1072794406 | ● FA1071194406 | ● FA1072314406 |
| ● FA1072794412 | ● FA1071194412 | ● FA1072314412 |
| ● FA1072794418 | ● FA1071194418 | ● FA1072314418 |
| ● FA1072794430 | ● FA1071194430 | ● FA1072314430 |
| ● FA1072794433 | ● FA1071194433 | ● FA1072314433 |

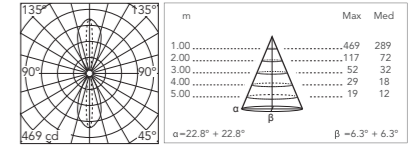

Optic Flood 75°

Power Led: 4W - LED 2x139 lm \neq OUTPUT 2x101lm - 2700K/CRI 80 - 100 \pm 240V / 4W - LED 2x149 lm \neq OUTPUT 2x108 lm - 3000K/CRI 80 - 100 \pm 240V / 4W - LED 2x154 lm \neq OUTPUT 2x111 lm - 4000K/CRI 80 - 100 \pm 240V

- | | | |
|----------------|----------------|----------------|
| 2700K | 3000K | 4000K |
| ○ FA1072795101 | ○ FA1071195101 | ○ FA1072315101 |
| ● FA1072795106 | ● FA1071195106 | ● FA1072315106 |
| ● FA1072795112 | ● FA1071195112 | ● FA1072315112 |
| ● FA1072795118 | ● FA1071195118 | ● FA1072315118 |
| ● FA1072795130 | ● FA1071195130 | ● FA1072315130 |
| ● FA1072795133 | ● FA1071195133 | ● FA1072315133 |

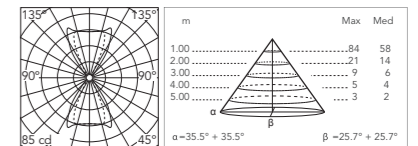

Optic Spot 10°+Flood 75°

Power Led: 4W - LED 2x139 lm \neq OUTPUT 2x103+101 lm - 2700K/CRI 80 - 100 \pm 240V / 4W - LED 2x149 lm \neq OUTPUT 2x110+108 lm - 3000K/CRI 80 - 100 \pm 240V / 4W - LED 2x154 lm \neq OUTPUT 2x114+111 lm - 4000K/CRI 80 - 100 \pm 240V

- | | | |
|----------------|----------------|----------------|
| 2700K | 3000K | 4000K |
| ○ FA1072725301 | ○ FA1071225301 | ○ FA1072315301 |
| ● FA1072725306 | ● FA1071225306 | ● FA1072315306 |
| ● FA1072725312 | ● FA1071225312 | ● FA1072315312 |
| ● FA1072725318 | ● FA1071225318 | ● FA1072315318 |
| ● FA1072725330 | ● FA1071225330 | ● FA1072315330 |
| ● FA1072725333 | ● FA1071225333 | ● FA1072315333 |

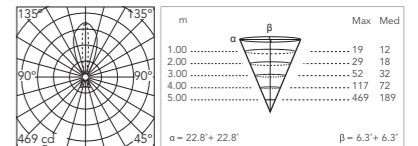

Marco Omnidirectional

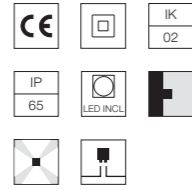
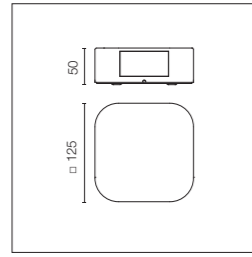

Sorgente luminosa a LED inclusa. Alimentazione elettrica 220-240V ON/ OFF integrata. Staffa di fissaggio a parete inclusa. Dotato di due pressacavi in gomma per cavi 5mm< ϕ <9mm per consentire una facile connessione entratesci.

LED source included. Integrated electric power supply 220-240V ON/OFF. Wall fixing bracket included. Equipped with two rubber cable guides (5mm< ϕ <9mm) that facilitate the inlet-outlet connection.

Optic Spot 10°

Power Led: 7W - LED 4x139 lm \neq OUTPUT 4x103 lm - 2700K/CRI 80 - 100 \pm 240V / 7W - LED 4x149 lm \neq OUTPUT 4x110 lm - 3000K/CRI 80 - 100 \pm 240V / 7W - LED 4x154 lm \neq OUTPUT 4x114 lm - 4000K/CRI 80 - 100 \pm 240V

2700K

- FA1072724701
- FA1072724706
- FA1072724712
- FA1072724718
- FA1072724730
- FA1072724733

3000K

- FA107924501
- FA107924506
- FA107924512
- FA107924518
- FA107924530
- FA107924533

4000K

- FA1072324501
- FA1072324506
- FA1072324512
- FA1072324518
- FA1072324530
- FA1072324533

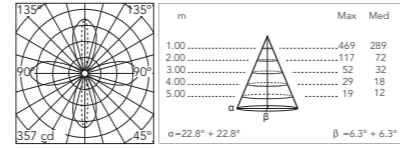

@ 3000K

Optic Flood 75°

Power Led: 7W - LED 4x139 lm \neq OUTPUT 4x101 lm - 2700K/CRI 80 - 100 \pm 240V / 7W - LED 4x149 lm \neq OUTPUT 4x108 lm - 3000K/CRI 80 - 100 \pm 240V / 7W - LED 4x154 lm \neq OUTPUT 4x111 lm - 4000K/CRI 80 - 100 \pm 240V

2700K

- FA1072724901
- FA1072724906
- FA1072724912
- FA1072724918
- FA1072724930
- FA1072724933

3000K

- FA107925201
- FA107925206
- FA107925212
- FA107925218
- FA107925230
- FA107925233

4000K

- FA1072325201
- FA1072325206
- FA1072325212
- FA1072325218
- FA1072325230
- FA1072325233

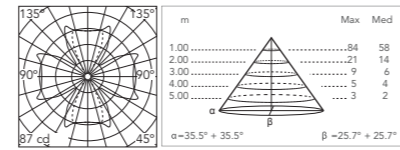

@ 3000K

Marco: Accessori / Accessories

Dispositivo di protezione per il sovraccarico. 275Vac. Corrente massima di scarica 10KA (8/29 μ s). Massima corrente operativa 5A. Adatto per la connessione in serie. IP66.

Surge protection device. 275Vac. Maximum discharge current 10KA (8/20 μ s). Maximum operating current 5A. Suitable for series connection. IP66.

F990E00A000

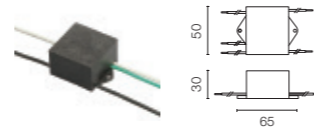

Fenestra



Designed by Flos Outdoor



Fenestra

Famiglia / Family

Fenestra 24V



Power Led

4W
165 lm - 2700K/CRI 80
183 lm - 3000K/CRI 80
201 lm - 4000K/CRI 80

Fenestra



Power Led

5,5W
165 lm - 2700K/CRI 80
183 lm - 3000K/CRI 80
201 lm - 4000K/CRI 80

Descrizione / Description

Apparecchio per esterni installabile in vano finestra con fonte di luce a LED.

Corpo dell'apparecchio realizzato in alluminio pressofuso EN AB-47100 a basso contenuto di rame.

Rivestimento ad alta resistenza: dopo un trattamento di sabbiatura di tutti i componenti per rendere la superficie porosa e garantire una maggiore adesione della vernice, è applicato il rivestimento esterno con un doppio strato con polveri secondo lo standard QUALICOAT. Il primo strato di polvere epossidica dà resistenza chimica e meccanica, il secondo strato di finitura di polvere poliestere assicura resistenza ai raggi UV ed agli agenti atmosferici.

Le superfici verniciate sono trattate con lavaggi alcalini e acidi, risciacquate con acqua demineralizzata e sottoposte a un trattamento di conversione chimica per proteggere contro l'ossidazione.

Grazie all'utilizzo di una doppia sorgente LED e di due lenti ad emissione lamellare è garantita una copertura di 270° con distribuzione omogenea e ottima uniformità cromatica. Diffusore in policarbonato stabilizzato ai raggi UV, guarnizione in silicone.

Ogni apparecchio è dotato di un sistema meccanico di regolazione, di circa 10°, che consente di compensare l'inclinazione dei davanzali e permette il corretto orientamento del fascio luminoso.

Luminaire for outdoor use for installation in a window compartment with LED light source.

Luminaire body in die-cast aluminum EN AB-47100 (low copper content).

High-resistance coating: after a sandblasting treatment of all components to make the surface porous and ensure a greater adhesion of the paint, the external coating is applied with a double layer with epoxy powders according to the QUALICOAT standard. The first layer of epoxy powder gives chemical and mechanical resistance, the second finishing layer of polyester powder ensures resistance to UV rays and atmospheric agents.

The painted surfaces are treated with alkaline and acidic washes, then rinsed with demineralized water, subjected to a chemical conversion treatment to protect against oxidation.

Thanks to the use of a dual LED source and two laminar emitting lenses, it guarantees a coverage of 270° with homogeneous distribution and excellent color uniformity.

UV-stabilized polycarbonate diffuser, silicone seal. Each luminaire is equipped with a mechanical adjustment system of up to 10° to compensate the tilting of the parapet and thus correctly orient the light beam.

Colori / Colours



01 White



06 Grey



12 Forest Green

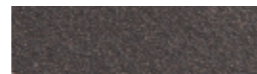

18 Deep Brown



30 Black



33 Anthracite

Fenestra 24V

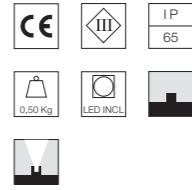
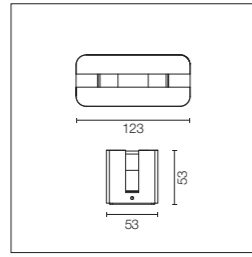

Alimentazione elettrica remota 12-24V da ordinare separatamente. Dotata di uno spezzone di cavo uscente in neoprene di 1000 mm.

12-24V remote power supply to be ordered separately. Equipped with a 1000 mm length outgoing neoprene cable.

Power Led: 4W - 274 lm ≠ FIXT 165 lm - 2700K/CRI 80 - 12-24V / 4W - 304 lm ≠ FIXT 183 lm - 3000K/CRI 80 - 12-24V / 4W - 334 lm ≠ FIXT 201 lm - 4000K/CRI 80 - 12-24V

2700K

- F2250001
- F2250006
- F2250012
- F2250018
- F2250030
- F2250033

3000K

- F2251001
- F2251006
- F2251012
- F2251018
- F2251030
- F2251033

4000K

- F2252001
- F2252006
- F2252012
- F2252018
- F2252030
- F2252033

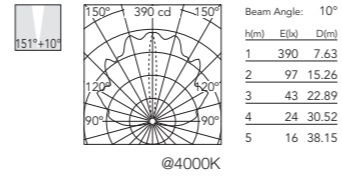

Fenestra

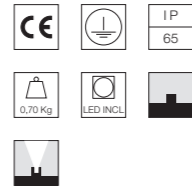
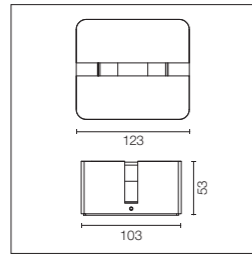

Alimentazione elettrica 100/240V integrata. Dotata di uno spezzone di cavo uscente in neoprene di 1000 mm. Versione dimmerabile a richiesta.

Integrated 100/240V power supply. Equipped with an 1000 mm length outgoing neoprene cable. Dimmable version on request.

Power Led: 5,5W - 274 lm ≠ FIXT 165 lm - 2700K/CRI 80 - 100-240V / 5,5W - 304 lm ≠ FIXT 183 lm - 3000K/CRI 80 - 100-240V / 5,5W - 334 lm ≠ FIXT 201 lm - 4000K/CRI 80 - 100-240V

2700K

- F2260001
- F2260006
- F2260012
- F2260018
- F2260030
- F2260033

3000K

- F2261001
- F2261006
- F2261012
- F2261018
- F2261030
- F2261033

4000K

- F2262001
- F2262006
- F2262012
- F2262018
- F2262030
- F2262033

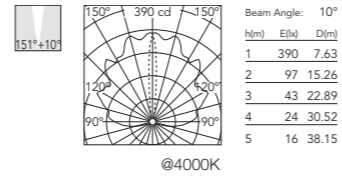

Regolazione dell'apparecchio per superfici di appoggio non planari Luminaire adjustment for non-planar surfaces

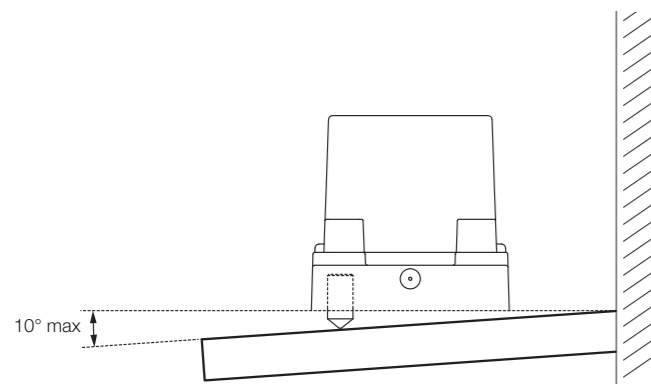

Fenestra 24V: Accessori / Accessories

Dispositivo di protezione per il sovraccarico. 275Vac Corrente massima di scarica 10KA (8/29us). Massima corrente operativa 5A. Adatto per la connessione in serie. IP66.

Surge protection device. 275Vac. Maximum discharge current 10KA (8/20us). Maximum operating current 5A. Suitable for series connection. IP66.

F990E00A000

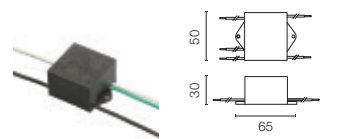

Fenestra 24V: Driver / Drivers

Alimentatore 24V 8W / 110-240V IP20 Classe II selv.

Power supply 24V 8W / 110-240V IP20 Class II selv.

*RF25754

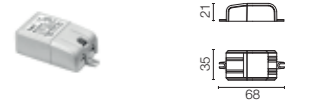

Alimentatore 24V 8W / 110-240V IP65 Classe II selv.

Power supply 24V 8W / 110-240V IP65 Class II selv.

*RF25748

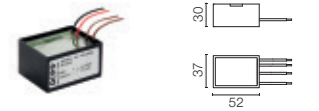

Alimentatore 24V 10W / 110-240V IP20 Classe II selv.

Power supply 24V 10W / 110-240V IP20 Class II selv.

*RF25747

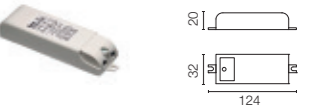

Alimentatore 24V 10W / 110-240V IP67 Classe II selv.

Power supply 24V 10W / 110-240V IP67 Class II selv.

*RF25757

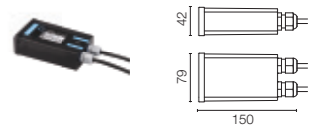

Alimentatore 24Vdc 35W / 120-270V IP67 Classe II selv.

Power supply 24Vdc 35W / 120-270V IP67 Class II selv.

*F990B23AZ00

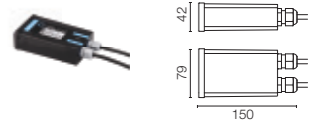

Alimentatore 24Vdc 50W / 120-240V IP67 Classe II selv.

Power supply 24Vdc 50W / 120-240V IP67 Class II selv.

*RF25755

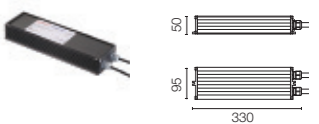

Alimentatore 24Vdc 70W / 220-240V IP67 Classe II selv.

Power supply 24Vdc 70W / 220-240V IP67 Class II selv.

*RF25749

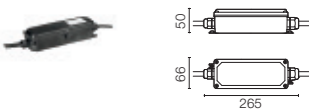

* Numero massimo di apparecchi per alimentatore / Maximum number of luminaires per power supply.

Numero massimo di apparecchi per alimentatore (Vin220-240). Dati indicativi da verificare con le specifiche condizioni di installazione.

Maximum number of luminaires per power supply. (220-240 V). These data must be checked taking into account the specific installation conditions.

Acc. RF25754	1
Acc. RF25748	1
Acc. RF25747	2
Acc. RF25757	2
Acc. F990B23AZ00	6
Acc. RF25755	9
Acc. RF25749	13

A-Round



Designed by Piero Lissoni



Famiglia / Family

A-Round 315



Power Led

42W
3432 lm - 2700K/CRI 80
3978 lm - 3000K/CRI 80
4290 lm - 4000K/CRI 80

A-Round 240



Power Led

21W
1760 lm - 2700K/CRI 80
2040 lm - 3000K/CRI 80
2200 lm - 4000K/CRI 80

A-Round 150



Power Led

8W
572 lm - 2700K/CRI 80
663 lm - 3000K/CRI 80
715 lm - 4000K/CRI 80

Colori / Colours



65 Matt Copper



45 Matt Gold



48 Matt Bronze



56 Matt Stainless Steel

Orientabilità sull'asse verticale: max 15°

Adjustment on the vertical axis: max 15°

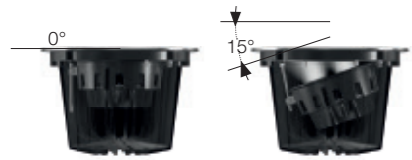

Rotazione intorno all'asse orizzontale: max 359°

Rotation around the horizontal axis: max 359°



Descrizione / Description

Apparecchio a LED da incasso a terra per esterni, calpe-stabile e carrabile, disponibile in tre dimensioni, con ottica orientabile e regolabile in diverse configurazioni. Ghiera esterna in acciaio inox AISI 316L trattato con processo PVD (Physical Vapour Deposition). Grazie a questo innovativo trattamento, le superfici dell'A-Round sono ricoperte da un sottile film di metalli come zirconio e titanio che, combinandosi con l'acciaio a livello molecolare, ne aumentano le caratteristiche di resistenza sia meccanica che agli agenti atmosferici, permettendo la realizzazione di finiture pregiate e durevoli. Corpo dell'apparecchio realizzato in alluminio pressofuso EN AB-47100 a basso contenuto di rame, rivestito con doppio strato di vernice ad alta resistenza alla corrosione. Vetro trasparente temperato ad alta resistenza, serigrafato per ridurre l'abbagliamento. Driver per installazione remota incluso, fornito di connettore di aggancio rapido M12 a tenuta stagna. L'installazione richiede una cassaforma da incasso, da ordinare separatamente. È necessario garantire un livello adeguato di ghiaia (> 300 mm) o fornire un sistema di scarico per assicurare il drenaggio ed evitare il ristagno di acqua. Per garantire la tenuta del pressacavo è necessario utilizzare cavi elettrici flessibili idonei all'impiego in ambienti esterni.

Ground-recessed luminaire for outdoor use, walkable and trafficable, available in three sizes, with adjustable optics in various configurations. External body made of stainless steel AISI 316L treated with the PVD process (Physical Vapour Deposition). Thanks to this innovative treatment, the surfaces of A-Round are coated with a thin film of metals, such as zirconium and titanium which, combining with the steel at the molecular level, increases the resistance to both, mechanical and atmospheric agents, permitting the execution of elegant and durable finishings. The body of the luminaire is made of die-cast aluminum EN AB-47100 with low copper content, coated with two layers of paint with high resistance to corrosion. High-strength tempered clear glass, screen-printed to reduce glare. Driver for remote installation included, provided with M12 quick connector for watertight coupling. Installation requires a housing for flush mounting, to be ordered separately. It is necessary to provide an adequate level of gravel (> 300 mm) or a drain system to ensure drainage and avoid water stagnation. To ensure the sealing of the cable gland it is necessary to use flexible electric cables suitable for use in outdoor environments.

A-Round 315

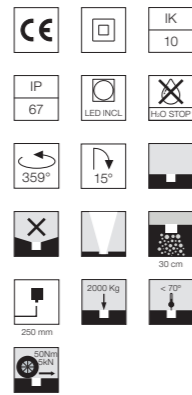
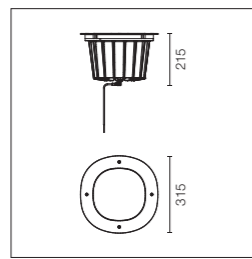

Alimentazione elettrica 220/240V integrata. Necessaria cassaforma, da ordinare separatamente.
Orientabilità sull'asse verticale: max 15°. Rotazione intorno all'asse orizzontale: max 359°.

Integrated 220/240V power supply. Box for installation required, to be ordered separately.
Adjustment on the vertical axis: max 15°. Rotation around the horizontal axis: max 359°.

Power Led: 42W - 3432 lm ≠ *FIXT 3203 lm - 2700K/CRI 80 - 220-240V / 42W - 3978 lm ≠ *FIXT 3447 lm - 3000K/CRI 80 - 220-240V / 42W - 4290 lm ≠ *FIXT 3707 lm - 4000K/CRI 80 - 220-240V
*FIXT lm = Spot Optic

Optic Spot

2700K

- Non Dimmable
- F4588065
- F4588045
- F4588048
- F4588056
- 1-10V
- F4588065-310
- F4588045-310
- F4588048-310
- F4588056-310
- Dali
- F4588065-300
- F4588045-300
- F4588048-300
- F4588056-300

3000K

- Non Dimmable
- F4591065
- F4591045
- F4591048
- F4591056
- 1-10V
- F4591065-310
- F4591045-310
- F4591048-310
- F4591056-310
- Dali
- F4591065-300
- F4591045-300
- F4591048-300
- F4591056-300

4000K

- Non Dimmable
- F4594065
- F4594045
- F4594048
- F4594056
- 1-10V
- F4594065-310
- F4594045-310
- F4594048-310
- F4594056-310
- Dali
- F4594065-300
- F4594045-300
- F4594048-300
- F4594056-300

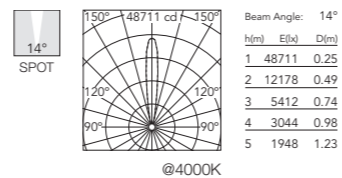

Optic Medium

2700K

- Non Dimmable
- F4589065
- F4589045
- F4589048
- F4589056
- 1-10V
- F4589065-310
- F4589045-310
- F4589048-310
- F4589056-310
- Dali
- F4589065-300
- F4589045-300
- F4589048-300
- F4589056-300

3000K

- Non Dimmable
- F4592065
- F4592045
- F4592048
- F4592056
- 1-10V
- F4592065-310
- F4592045-310
- F4592048-310
- F4592056-310
- Dali
- F4592065-300
- F4592045-300
- F4592048-300
- F4592056-300

4000K

- Non Dimmable
- F4595065
- F4595045
- F4595048
- F4595056
- 1-10V
- F4595065-310
- F4595045-310
- F4595048-310
- F4595056-310
- Dali
- F4595065-300
- F4595045-300
- F4595048-300
- F4595056-300

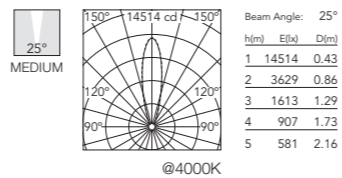

Optic Flood

2700K

- Non Dimmable
- F4590065
- F4590045
- F4590048
- F4590056
- 1-10V
- F4590065-310
- F4590045-310
- F4590048-310
- F4590056-310
- Dali
- F4590065-300
- F4590045-300
- F4590048-300
- F4590056-300

3000K

- Non Dimmable
- F4593065
- F4593045
- F4593048
- F4593056
- 1-10V
- F4593065-310
- F4593045-310
- F4593048-310
- F4593056-310
- Dali
- F4593065-300
- F4593045-300
- F4593048-300
- F4593056-300

4000K

- Non Dimmable
- F4596065
- F4596045
- F4596048
- F4596056
- 1-10V
- F4596065-310
- F4596045-310
- F4596048-310
- F4596056-310
- Dali
- F4596065-300
- F4596045-300
- F4596048-300
- F4596056-300

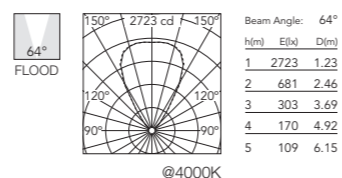

A-Round 240

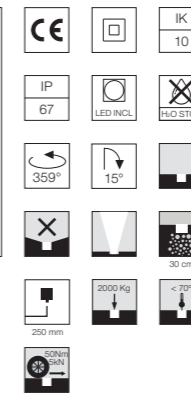
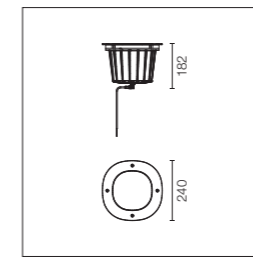

Alimentazione elettrica 220/240V integrata. Necessaria cassaforma, da ordinare separatamente.
Orientabilità sull'asse verticale: max 15°. Rotazione intorno all'asse orizzontale: max 359°.

Integrated 220/240V power supply. Box for installation required, to be ordered separately.
Adjustment on the vertical axis: max 15°. Rotation around the horizontal axis: max 359°.

Power Led: 21W - 1760 lm ≠ *FIXT 1623 lm - 2700K/CRI 80 - 220-240V / 21W - 2040 lm ≠ *FIXT 1747 lm - 3000K/CRI 80 - 220-240V / 21W - 2200 lm ≠ *FIXT 1878 lm - 4000K/CRI 80 - 220-240V
*FIXT lm = Spot Optic

Optic Spot

2700K

- Non Dimmable
- F4579065
- F4579045
- F4579048
- F4579056
- 1-10V
- F4579065-310
- F4579045-310
- F4579048-310
- F4579056-310
- Dali
- F4579065-300
- F4579045-300
- F4579048-300
- F4579056-300

3000K

- Non Dimmable
- F4582065
- F4582045
- F4582048
- F4582056
- 1-10V
- F4582065-310
- F4582045-310
- F4582048-310
- F4582056-310
- Dali
- F4582065-300
- F4582045-300
- F4582048-300
- F4582056-300

4000K

- Non Dimmable
- F4585065
- F4585045
- F4585048
- F4585056
- 1-10V
- F4585065-310
- F4585045-310
- F4585048-310
- F4585056-310
- Dali
- F4585065-300
- F4585045-300
- F4585048-300
- F4585056-300

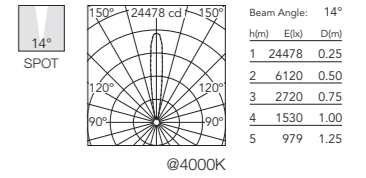

Optic Medium

2700K

- Non Dimmable
- F4580065
- F4580045
- F4580048
- F4580056
- 1-10V
- F4580065-310
- F4580045-310
- F4580048-310
- F4580056-310
- Dali
- F4580065-300
- F4580045-300
- F4580048-300
- F4580056-300

3000K

- Non Dimmable
- F4583065
- F4583045
- F4583048
- F4583056
- 1-10V
- F4583065-310
- F4583045-310
- F4583048-310
- F4583056-310
- Dali
- F4583065-300
- F4583045-300
- F4583048-300
- F4583056-300

4000K

- Non Dimmable
- F4586065
- F4586045
- F4586048
- F4586056
- 1-10V
- F4586065-310
- F4586045-310
- F4586048-310
- F4586056-310
- Dali
- F4586065-300
- F4586045-300
- F4586048-300
- F4586056-300

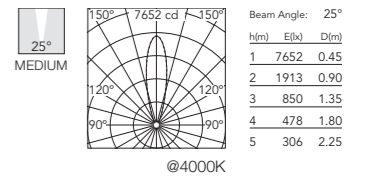

Optic Flood

2700K

- Non Dimmable
- F4581065
- F4581045
- F4581048
- F4581056
- 1-10V
- F4581065-310
- F4581045-310
- F4581048-310
- F4581056-310
- Dali
- F4581065-300
- F4581045-300
- F4581048-300
- F4581056-300

3000K

- Non Dimmable
- F4584065
- F4584045
- F4584048
- F4584056
- 1-10V
- F4584065-310
- F4584045-310
- F4584048-310
- F4584056-310
- Dali
- F4584065-300
- F4584045-300
- F4584048-300
- F4584056-300

4000K

- Non Dimmable
- F4587065
- F4587045
- F4587048
- F4587056
- 1-10V
- F4587065-310
- F4587045-310
- F4587048-310
- F4587056-310
- Dali
- F4587065-300
- F4587045-300
- F4587048-300
- F4587056-300

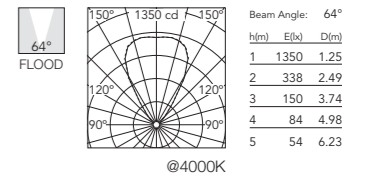

A-Round 150

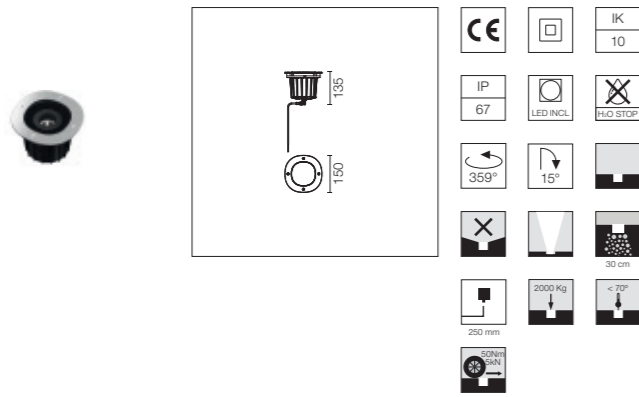

Alimentazione elettrica 110/240V integrata. Necessaria cassaforma, da ordinare separatamente. Versione dimmerabile a richiesta. Orientabilità sull'asse verticale: max 15°. Rotazione intorno all'asse orizzontale: max 359°.

Integrated 110/240V power supply. Box for installation required, to be ordered separately. Dimmable version on request. Adjustment on the vertical axis: max 15°. Rotation around the horizontal axis: max 359°.

Power Led: 8W - 572 lm ≠ *FIXT 536 lm - 2700K/CRI 80 - 110-240V / 8W - 663 lm ≠ *FIXT 576 lm - 3000K/CRI 80 - 110-240V / 8W - 715 lm ≠ *FIXT 620 lm - 4000K/CRI 80 - 110-240V
 *FIXT lm = Spot Optic

Optic Spot

- | | | |
|--------------|--------------|--------------|
| 2700K | 3000K | 4000K |
| ● F4570065 | ● F4573065 | ● F4576065 |
| ● F4570045 | ● F4573045 | ● F4576045 |
| ● F4570048 | ● F4573048 | ● F4576048 |
| ● F4570056 | ● F4573056 | ● F4576056 |

Optic Medium

- | | | |
|--------------|--------------|--------------|
| 2700K | 3000K | 4000K |
| ● F4571065 | ● F4574065 | ● F4577065 |
| ● F4571045 | ● F4574045 | ● F4577045 |
| ● F4571048 | ● F4574048 | ● F4577048 |
| ● F4571056 | ● F4574056 | ● F4577056 |

Optic Flood

- | | | |
|--------------|--------------|--------------|
| 2700K | 3000K | 4000K |
| ● F4572065 | ● F4575065 | ● F4578065 |
| ● F4572045 | ● F4575045 | ● F4578045 |
| ● F4572048 | ● F4575048 | ● F4578048 |
| ● F4572056 | ● F4575056 | ● F4578056 |

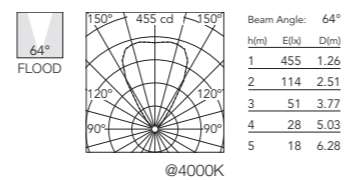
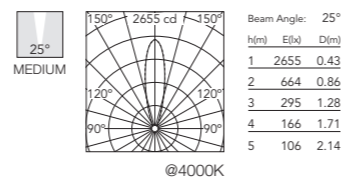
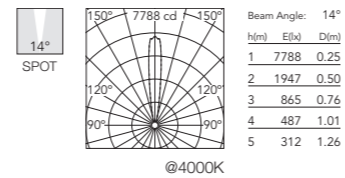

A-Round: Accessori / Accessories

Honeycomb.	Honeycomb.	A-Round 315 - 4 Units Kit F4557000	
Lente flood.	Flood lens.	A-Round 315 - 4 Units Kit F4560000	
Cassaforma.	Box for installation.	A-Round 315 F4599000	 Dimensions: 280mm height, 270mm width, 286mm diameter.
Honeycomb.	Honeycomb.	A-Round 240 - 4 Units Kit F4556000	
Lente flood.	Flood lens.	A-Round 240 - 4 Units Kit F4559000	
Cassaforma.	Box for installation.	A-Round 240 F4598000	 Dimensions: 280mm height, 220mm width, 222mm diameter.
Honeycomb.	Honeycomb.	A-Round 150 - 4 Units Kit F4555000	
Lente flood.	Flood lens.	A-Round 150 - 4 Units Kit F4558000	
Cassaforma.	Box for installation.	A-Round 150 F4597000	 Dimensions: 190mm height, 142mm diameter, 210mm width.
Sistema di giunzione IP68 H2O Stop anti-condensa a 2 vie 4 poli. (Ø5,5÷12mm cavo).	2 way terminal block 4 poles IP68 H2O Stop. (ø5,5÷12mm cable).	F990C00A000	 Dimensions: 80mm length, 22mm width.
Sistema di giunzione IP68 H2O Stop anti-condensa a 3/4 vie 4 poli. (Ø5,5÷12mm cavo).	3/4 way terminal block 4 poles IP68 H2O Stop. (ø5,5÷12mm cable).	F990C010000	
Dispositivo di protezione per il sovraccarico. 275Vac. Corrente massima di scarica 10KA (8/29us). Massima corrente operativa 5A. Adatto per la connessione in serie. IP66.	Surge protection device. 275Vac. Maximum discharge current 10KA (8/20us). Maximum operating current 5A. Suitable for series connection. IP66.	F990E00A000	 Dimensions: 65mm length, 30mm height, 50mm width.

A-Rise



A-Rise



A-Rise 290



Power Led
up to 39W
up to 2956 lm - 2700K/CRI 80
up to 3167 lm - 3000K/CRI 80
up to 3273 lm - 4000K/CRI 80
* Net lumen output

CoB Led
up to 38W
up to 3093 lm - 2700K/CRI 80
up to 3326 lm - 3000K/CRI 80
up to 3411 lm - 4000K/CRI 80
* Net lumen output

A-Rise 225



Power Led
up to 21W
up to 1478 lm - 2700K/CRI 80
up to 1584 lm - 3000K/CRI 80
up to 1636 lm - 4000K/CRI 80
* Net lumen output

CoB Led
up to 21W
up to 1739 lm - 2700K/CRI 80
up to 1870 lm - 3000K/CRI 80
up to 1961 lm - 4000K/CRI 80
* Net lumen output

A-Rise 145



Power Led
up to 8W
up to 472 lm - 2700K/CRI 80
up to 507 lm - 3000K/CRI 80
up to 583 lm - 4000K/CRI 80
* Net lumen output

CoB Led
up to 9W
up to 545 lm - 2700K/CRI 80
up to 586 lm - 3000K/CRI 80
up to 610 lm - 4000K/CRI 80
* Net lumen output

A-Rise 130



Mid - Power Led
up to 7W
up to 453 lm - 3000K/CRI 80
up to 479 lm - 4000K/CRI 80
* Net lumen output

A-Rise 65



Power Led
up to 3,4W
up to 138 lm - 2700K/CRI 80
up to 149 lm - 3000K/CRI 80
up to 155 lm - 4000K/CRI 80
* Net lumen output

A-Rise 65 High Emission



Power Led
up to 4,5W
up to 246 lm - 2700K/CRI 80
up to 267 lm - 3000K/CRI 80
up to 277 lm - 4000K/CRI 80
* Net lumen output

A-Rise 49



Power Led
up to 2,3W
up to 106 lm - 2700K/CRI 80
up to 115 lm - 3000K/CRI 80
up to 119 lm - 4000K/CRI 80
* Net lumen output

Colori / Colours



56 Matt Stainless Steel

Famiglia completa di apparecchi di illuminazione ad incasso a terra con sorgente luminosa a LED, caratterizzati dalla geometria tonda, adattabile alle molteplici situazioni di installazione architettonica. Disponibili in differenti tagli dimensionali e molteplici fasci di apertura. Le ghiera esterne di chiusura sono realizzate in acciaio inox 316L, trattate con processo di pallinatura tale da migliorare la resistenza a fatica del componente e donare un'estetica finale di satinatura fine. Le viterie di fissaggio sono in acciaio inox AISI 316L.

L'installazione richiede una cassaforma da incasso da ordinare separatamente. È necessario garantire un livello adeguato di materiale drenante sotto la cassaforma o fornire un sistema di scarico per evitare il ristagno di acqua. Per garantire la tenuta del pressacavo è necessario utilizzare cavi elettrici flessibili idonei all'impiego in ambienti esterni.

A-Rise 145 / 225 / 290

Apparecchio ad incasso a terra calpestabile e carrabile, disponibile in tre dimensioni di diametro e in molteplici fasci di apertura, con ottica basculante sull'asse verticale e orientabile sull'asse orizzontale, per una completa flessibilità di modulazione dell'effetto desiderato sulla superficie da illuminare. La posizione arretrata della sorgente luminosa permette di ridurre notevolmente l'abbagliamento diretto garantendo un comfort visivo ottimale. Corpo dell'apparecchio e dissipatore realizzato in alluminio pressofuso EN AB-47100 a basso contenuto di rame, rivestito con doppio strato di vernice ad alta resistenza alla corrosione. Ghiera esterna in acciaio inox AISI 316L pallinato. Vetro trasparente temperato ad alta resistenza, serigrafato per ridurre l'abbagliamento e fissato attraverso un sistema di incollaggio robotizzato alla contro ghiera. L'apparecchio è dotato di un connettore a vite M12 a tenuta stagna che fornisce isolamento ottimale contro la penetrazione di acqua e rapido collegamento con l'unità di cablaggio, in dotazione con l'apparecchio come un kit IP67 remoto da alloggiare nella cassaforma da incasso.

A-Rise 130

Apparecchio ad incasso a parete e a terra calpestabile, caratterizzata dalla ridotta profondità di incasso che ne permette l'uso anche in pareti divisorie di 80 mm. Fascio di apertura flood per una emissione morbida e diffusa, disponibile in due tagli di potenza e flusso luminoso emesso per poter gestire differenti esigenze di illuminazione. Corpo dell'apparecchio e dissipatore realizzato in alluminio pressofuso EN AB-47100 a basso contenuto di rame, rivestito con doppio strato di vernice ad alta resistenza alla corrosione. Ghiera esterna in acciaio inox AISI 316L pallinato. Diffusore in vetro sabbato e serigrafato centralmente per ridurre l'abbagliamento, fissato attraverso un sistema di incollaggio robotizzato. Disponibile versione con modulo led in tensione di rete e versione a 24V dc che necessita di alimentatore remoto da ordinare separatamente.

A-Rise 49 / A-Rise 65

Apparecchi ad incasso a terra calpestabili, predisposti per installazione ad incasso a parete o a controsoffitto nella versione con molle. Declinati in due dimensioni di diametro e caratterizzati dalla forma compatta e dall'assenza di viti a vista; disponibili in differenti fasci di apertura e di diffusione della luce. La posizione leggermente arretrata della sorgente luminosa permette di ridurre l'abbagliamento diretto. Corpo dell'apparecchio in alluminio tornito lega EN AW 6060 con trattamento di anodizzazione ad alta resistenza alla corrosione. Ghiera esterna in acciaio inox AISI 316L pallinato. Diffusore in policarbonato trasparente per le versioni con fascio stretto e medio, policarbonato opale per la versione a luce diffusa. Apparecchio in 24V dc, necessita di alimentatore remoto da ordinare separatamente.

Complete family of ground recessed luminaires with LED source. They are characterized by their curved lines, which adapt to different architectural installation conditions. Available in different sizes and different beam angles. External caps made of 316L stainless steel, shot-blasted to improve its resistance to stress and its aesthetics with a slightly satin finish. The fixing screws are made of AISI 316L stainless steel. The installation requires a recessed box to be ordered separately. To avoid water stagnation, it is necessary to insulate the lower part of the box with a layer of drainage material or other drainage system. In order to guarantee the preservation of the cable guide, it is recommended to use flexible electric cables specifically designed for outdoor use.

A-Rise 145 / 225 / 290

Ground recessed and walk-over luminaire. Available in three different diameters and different beam angles. Equipped with a visor that tilts on the vertical axis and that is adjustable on the horizontal axis in order to adjust brightness and to perfectly adapt it to the desired effect on the surface. The rear position of the light source contributes to a considerable reduction of direct glare, thus ensuring excellent visual comfort. The structure and sink are made of EN AB-47100 die-cast aluminum (with low copper content), coated with a double layer of highly corrosion-resistant paint. The external cap is made of AISI 316L shot-blasted stainless steel. Tempered, transparent glass for higher resistance, silkscreened in order to reduce glare. Fixed to the ring of the external cap through a robotic gluing system. Equipped with an M12 watertight screw-on connector which completely isolates it from water infiltration and guarantees a quick connection with the supplied wiring, together with a remote IP67 kit to be installed in the box for recessing.

A-Rise 130

Ground recessed and walk-over luminaire characterized by a shallow recessing which allows its installation in 80 mm partition walls. Wide beam angle for a smooth and diffused light. Available in two power factors and two luminous fluxes to meet different lighting requirements. EN AB-47100 die-cast aluminium structure and sink (with low copper content), coated with a double layer of highly corrosion-resistant paint. AISI 316L shot-blasted stainless steel external cap. Frosted glass diffuser, silkscreened at the center in order to reduce glare and fixed through a robotic gluing system. Available in two versions: 24V and line voltage LED module. The 24V version requires a remote power supply to be ordered separately.

A-Rise 49 / A-Rise 65

Spring-loaded version of the ground recessed and walk-over luminaire, designed to be recessed in walls or false ceilings. Available in two different diameters, it is characterized by its compact shape and the absence of visible screws. Available with different light diffusion and beam angles. The slightly rear position of the light source contributes to reduce the direct glare. Structure in turned aluminium, EN AW 6060 alloy, anodized for better resistance to corrosion. 316L shot-blasted stainless steel external cap. Transparent polycarbonate diffuser for narrow and medium beam versions and opal polycarbonate diffuser for diffused light versions. The 24V dc luminaire is powered by a remote power supply to be ordered separately.

A-Rise 290

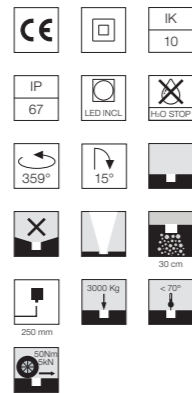
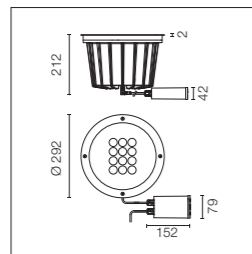

Sorgente a LED inclusa.
Alimentazione elettrica 220-240V ON/ OFF integrata.
Orientabilità asse verticale: max 15°. Rotazione asse orizzontale: max 359°. Alimentatore remoto da alloggiare in cassaforma dotato di spezzone di cavo 400mm con connettore a vite M12 a tenuta stagna all'apparecchio e di uno spezzone di cavo 250mm per il collegamento alla linea elettrica.
Vetro trasparente extrachiaro.

LED light source included.
Integrated 24V dc ON/OFF remote electric power supply.
Adjustment on vertical axis: 15° max. Rotation on horizontal axis: 359° max. Remote power supply that must be placed in a junction box, equipped with a protruding, 400 mm cable with an M12 screw-on connector that guarantees the water tightness of the luminaire, and with a 250 mm cable for the connection to the power line.
Extra clear transparent glass.

Optic Spot 10°

Power Led: 39W - 3864 lm ≠ OUTPUT 2956 lm - 2700K/CRI 80 - 220÷240V / 39W - 4140 lm ≠ OUTPUT 3167 lm - 3000K/CRI 80 - 220÷240V / 39W - 4278 lm ≠ OUTPUT 3273 lm - 4000K/CRI 80 - 220÷240V

2700K	3000K	4000K
Non Dimmable	Non Dimmable	Non Dimmable
● FA53406356	● FA53403756	● FA53403656
1-10V	1-10V	1-10V
● FA53406356-310	● FA53403756-310	● FA53403656-310
Dali	Dali	Dali
● FA53406356-300	● FA53403756-300	● FA53403656-300

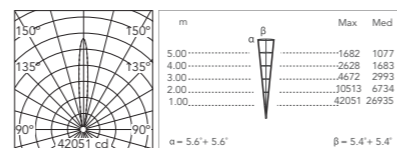

@ 3000K

Optic Medium 35°

Power Led: 39W - 3864 lm ≠ OUTPUT 2722 lm - 2700K/CRI 80 - 220÷240V / 39W - 4140 lm ≠ OUTPUT 2917 lm - 3000K/CRI 80 - 220÷240V / 39W - 4278 lm ≠ OUTPUT 3014 lm - 4000K/CRI 80 - 220÷240V

2700K	3000K	4000K
Non Dimmable	Non Dimmable	Non Dimmable
● FA53406456	● FA53404056	● FA53403956
1-10V	1-10V	1-10V
● FA53406456-310	● FA53404056-310	● FA53403956-310
Dali	Dali	Dali
● FA53406456-300	● FA53404056-300	● FA53403956-300

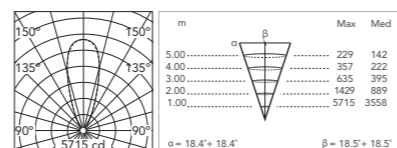

@ 3000K

Optic Flood 70°

Power Led: 39W - 3864 lm ≠ OUTPUT 2918 lm - 2700K/CRI 80 - 220÷240V / 39W - 4140 lm ≠ OUTPUT 3126 lm - 3000K/CRI 80 - 220÷240V / 39W - 4278 lm ≠ OUTPUT 3230 lm - 4000K/CRI 80 - 220÷240V

2700K	3000K	4000K
Non Dimmable	Non Dimmable	Non Dimmable
● FA53406556	● FA53404356	● FA53404256
1-10V	1-10V	1-10V
● FA53406556-310	● FA53404356-310	● FA53404256-310
Dali	Dali	Dali
● FA53406556-300	● FA53404356-300	● FA53404256-300

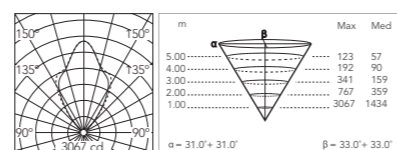

@ 3000K

A-Rise 290 Wall Washer

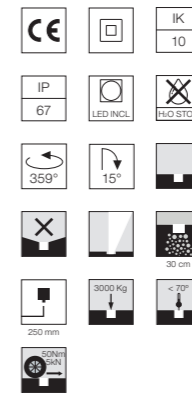
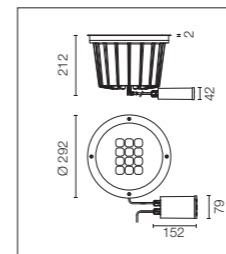

Sorgente a LED inclusa.
Alimentazione elettrica 220-240V ON/ OFF integrata.
Orientabilità asse verticale: max 15°. Rotazione asse orizzontale: max 359°. Alimentatore remoto da alloggiare in cassaforma dotato di spezzone di cavo 400mm con connettore a vite M12 a tenuta stagna all'apparecchio e di uno spezzone di cavo 250mm per il collegamento alla linea elettrica.
Vetro trasparente extrachiaro.

LED light source included.
Integrated 24V dc ON/OFF remote electric power supply.
Adjustment on vertical axis: 15° max. Rotation on horizontal axis: 359° max. Remote power supply that must be placed in a junction box, equipped with a protruding, 400 mm cable with an M12 screw-on connector that guarantees the water tightness of the luminaire, and with a 250 mm cable for the connection to the power line.
Extra clear transparent glass.

Optic Asymmetric 54°x 66°

Power Led: 39W - 3864 lm ≠ OUTPUT 2840 lm - 2700K/CRI 80 - 220÷240V / 39W - 4140 lm ≠ OUTPUT 3043 lm - 3000K/CRI 80 - 220÷240V / 39W - 4278 lm ≠ OUTPUT 3144 lm - 4000K/CRI 80 - 220÷240V

2700K	3000K	4000K
Non Dimmable	Non Dimmable	Non Dimmable
● FA53406656	● FA53404656	● FA53404556
1-10V	1-10V	1-10V
● FA53406656-310	● FA53404656-310	● FA53404556-310
Dali	Dali	Dali
● FA53406656-300	● FA53404656-300	● FA53404556-300

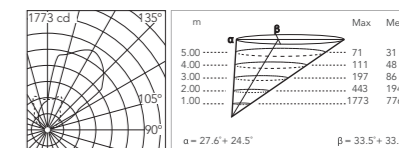

@ 3000K

A-Rise 290 High Emission

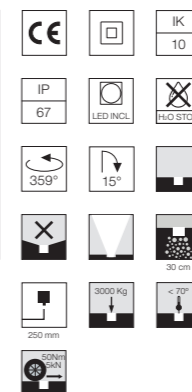
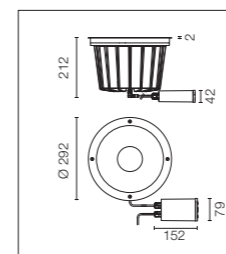

Sorgente a LED inclusa.
Alimentazione elettrica 220-240V ON/ OFF integrata.
Orientabilità asse verticale: max 15°. Rotazione asse orizzontale: max 359°. Alimentatore remoto da alloggiare in cassaforma dotato di spezzone di cavo 400mm con connettore a vite M12 a tenuta stagna all'apparecchio e di uno spezzone di cavo 250mm per il collegamento alla linea elettrica.
Vetro trasparente extrachiaro.

LED light source included.
Integrated 24V dc ON/OFF remote electric power supply.
Adjustment on vertical axis: 15° max. Rotation on horizontal axis: 359° max. Remote power supply that must be placed in a junction box, equipped with a protruding, 400 mm cable with an M12 screw-on connector that guarantees the water tightness of the luminaire, and with a 250 mm cable for the connection to the power line.
Extra clear transparent glass.

Optic Medium 40°

CoB Led: 38W - 4078 lm ≠ OUTPUT 3093 lm - 2700K/CRI 80 - 220÷240V / 38W - 4385 lm ≠ OUTPUT 3326 lm - 3000K/CRI 80 - 220÷240V / 38W - 4496 lm ≠ OUTPUT 3411 lm - 4000K/CRI 80 - 220÷240V

2700K	3000K	4000K
Non Dimmable	Non Dimmable	Non Dimmable
● FA53406756	● FA53404856	● FA53404756
1-10V	1-10V	1-10V
● FA53406756-310	● FA53404856-310	● FA53404756-310
Dali	Dali	Dali
● FA53406756-300	● FA53404856-300	● FA53404756-300

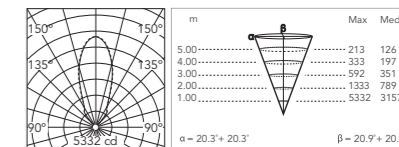

@ 3000K

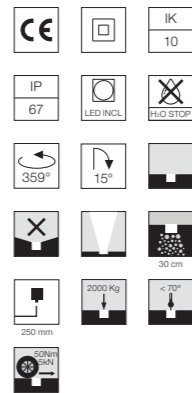
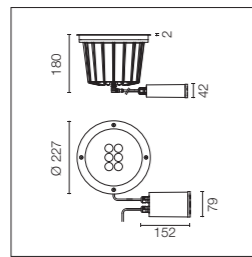

Sorgente a LED inclusa. Alimentazione elettrica 220-240V ON/ OFF integrata. Orientabilità asse verticale: max 15°. Rotazione asse orizzontale: max 359°. Alimentatore remoto da alloggiare in cassaforma dotato di spezzone di cavo 400mm con connettore a vite M12 a tenuta stagna all'apparecchio e di uno spezzone di cavo 250mm per il collegamento alla linea elettrica. Vetro trasparente extrachiaro.

LED light source included. Integrated 24V dc ON/OFF remote electric power supply. Adjustment on vertical axis: 15° max. Rotation on horizontal axis: 359° max. Remote power supply that must be placed in a junction box, equipped with a protruding, 400 mm cable with an M12 screw-on connector that guarantees the water tightness of the luminaire, and with a 250 mm cable for the connection to the power line. Extra clear transparent glass.

Optic Spot 10°

Power Led: 21W - 1932 lm ≠ OUTPUT 1478 lm - 2700K/CRI 80 - 220÷240V / 21W - 2070 lm ≠ OUTPUT 1584 lm - 3000K/CRI 80 - 220÷240V / 21W - 2139 lm ≠ OUTPUT 1636 lm - 4000K/CRI 80 - 220÷240V

- | | | |
|---|---|---|
| 2700K
Non Dimmable
● FA53405756
1-10V
● FA53405756-310
Dali
● FA53405756-300 | 3000K
Non Dimmable
● FA53402156
1-10V
● FA53402156-310
Dali
● FA53402156-300 | 4000K
Non Dimmable
● FA53402056
1-10V
● FA53402056-310
Dali
● FA53402056-300 |
|---|---|---|

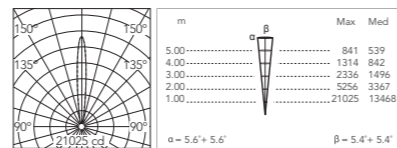

@ 3000K

Optic Medium 35°

Power Led: 21W - 1932 lm ≠ OUTPUT 1361 lm - 2700K/CRI 80 - 220÷240V / 21W - 2070 lm ≠ OUTPUT 1458 lm - 3000K/CRI 80 - 220÷240V / 21W - 2139 lm ≠ OUTPUT 1507 lm - 4000K/CRI 80 - 220÷240V

- | | | |
|---|---|---|
| 2700K
Non Dimmable
● FA53405856
1-10V
● FA53405856-310
Dali
● FA53405856-300 | 3000K
Non Dimmable
● FA53402456
1-10V
● FA53402456-310
Dali
● FA53402456-300 | 4000K
Non Dimmable
● FA53402356
1-10V
● FA53402356-310
Dali
● FA53402356-300 |
|---|---|---|

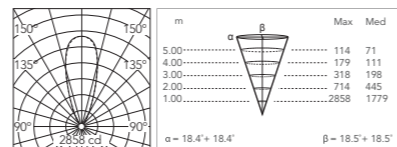

@ 3000K

Optic Flood 70°

Power Led: 21W - 1932 lm ≠ OUTPUT 1459 lm - 2700K/CRI 80 - 220÷240V / 21W - 2070 lm ≠ OUTPUT 1563 lm - 3000K/CRI 80 - 220÷240V / 21W - 2139 lm ≠ OUTPUT 1615 lm - 4000K/CRI 80 - 220÷240V

- | | | |
|---|---|---|
| 2700K
Non Dimmable
● FA53405956
1-10V
● FA53405956-310
Dali
● FA53405956-300 | 3000K
Non Dimmable
● FA53402756
1-10V
● FA53402756-310
Dali
● FA53402756-300 | 4000K
Non Dimmable
● FA53402656
1-10V
● FA53402656-310
Dali
● FA53402656-300 |
|---|---|---|

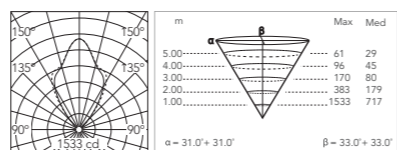

@ 3000K

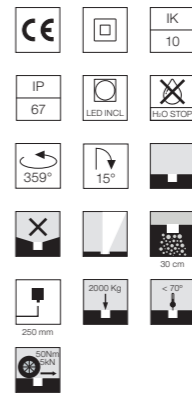
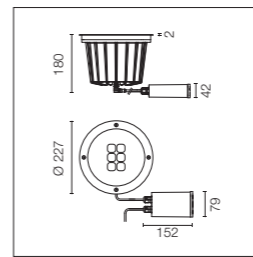

Sorgente a LED inclusa. Alimentazione elettrica 220-240V ON/ OFF integrata. Orientabilità asse verticale: max 15°. Rotazione asse orizzontale: max 359°. Alimentatore remoto da alloggiare in cassaforma dotato di spezzone di cavo 400mm con connettore a vite M12 a tenuta stagna all'apparecchio e di uno spezzone di cavo 250mm per il collegamento alla linea elettrica. Vetro trasparente extrachiaro.

LED light source included. Integrated 24V dc ON/OFF remote electric power supply. Adjustment on vertical axis: 15° max. Rotation on horizontal axis: 359° max. Remote power supply that must be placed in a junction box, equipped with a protruding, 400 mm cable with an M12 screw-on connector that guarantees the water tightness of the luminaire, and with a 250 mm cable for the connection to the power line. Extra clear transparent glass.

Optic Asymmetric 54°x 66°

Power Led: 21W - 1932 lm ≠ OUTPUT 1420 lm - 2700K/CRI 80 - 220÷240V / 21W - 2070 lm ≠ OUTPUT 1521 lm - 3000K/CRI 80 - 220÷240V / 21W - 2139 lm ≠ OUTPUT 1572 lm - 4000K/CRI 80 - 220÷240V

- | | | |
|---|---|---|
| 2700K
Non Dimmable
● FA53406056
1-10V
● FA53406056-310
Dali
● FA53406056-300 | 3000K
Non Dimmable
● FA53403056
1-10V
● FA53403056-310
Dali
● FA53403056-300 | 4000K
Non Dimmable
● FA53402956
1-10V
● FA53402956-310
Dali
● FA53402956-300 |
|---|---|---|

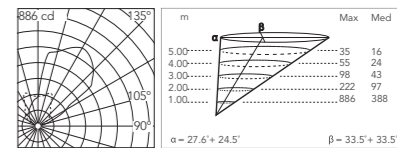

@ 3000K

A-Rise 225 High Emission

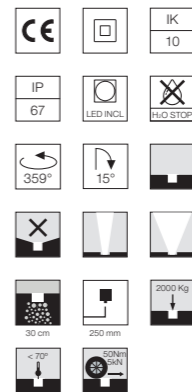
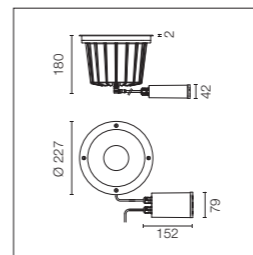

Sorgente a LED inclusa. Alimentazione elettrica 220-240V ON/ OFF integrata. Orientabilità asse verticale: max 15°. Rotazione asse orizzontale: max 359°. Alimentatore remoto da alloggiare in cassaforma dotato di spezzone di cavo 400mm con connettore a vite M12 a tenuta stagna all'apparecchio e di uno spezzone di cavo 250mm per il collegamento alla linea elettrica. Vetro trasparente extrachiaro.

LED light source included. Integrated 24V dc ON/OFF remote electric power supply. Adjustment on vertical axis: 15° max. Rotation on horizontal axis: 359° max. Remote power supply that must be placed in a junction box, equipped with a protruding, 400 mm cable with an M12 screw-on connector that guarantees the water tightness of the luminaire, and with a 250 mm cable for the connection to the power line. Extra clear transparent glass.

Optic Spot 16°

CoB Led: 21W - 2246 lm ≠ OUTPUT 1739 lm - 2700K/CRI 80 - 220÷240V / 21W - 2415 lm ≠ OUTPUT 1870 lm - 3000K/CRI 80 - 220÷240V / 21W - 2533 lm ≠ OUTPUT 1961 lm - 4000K/CRI 80 - 220÷240V

- | | | |
|---|---|---|
| 2700K
Non Dimmable
● FA53406156
1-10V
● FA53406156-310
Dali
● FA53406156-300 | 3000K
Non Dimmable
● FA53403256
1-10V
● FA53403256-310
Dali
● FA53403256-300 | 4000K
Non Dimmable
● FA53403156
1-10V
● FA53403156-310
Dali
● FA53403156-300 |
|---|---|---|

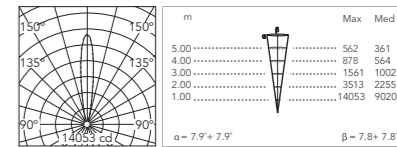

@ 3000K

Optic Medium 40°

CoB Led: 21W - 2246 lm ≠ OUTPUT 1673 lm - 2700K/CRI 80 - 220÷240V / 21W - 2415 lm ≠ OUTPUT 1799 lm - 3000K/CRI 80 - 220÷240V / 21W - 2533 lm ≠ OUTPUT 1886 lm - 4000K/CRI 80 - 220÷240V

- | | | |
|---|---|---|
| 2700K
Non Dimmable
● FA53406256
1-10V
● FA53406256-310
Dali
● FA53406256-300 | 3000K
Non Dimmable
● FA53403456
1-10V
● FA53403456-310
Dali
● FA53403456-300 | 4000K
Non Dimmable
● FA53403356
1-10V
● FA53403356-310
Dali
● FA53403356-300 |
|---|---|---|

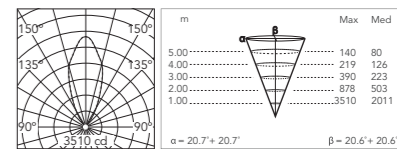

@ 3000K

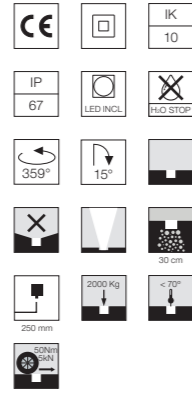
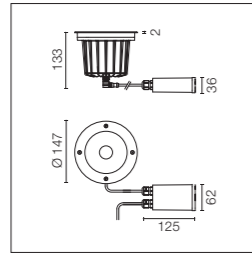

Sorgente a LED inclusa.
Alimentazione elettrica 220-240V ON/ OFF integrata.
Orientabilità asse verticale: max 15°. Rotazione asse orizzontale: max 359°. Alimentatore remoto da alloggiare in cassaforma dotato di spezzone di cavo 400mm con connettore a vite M12 a tenuta stagna all'apparecchio e di uno spezzone di cavo 250mm per il collegamento alla linea elettrica.
Vetro trasparente extrachiario.
Versione dimmerabile a richiesta.

LED light source included.
Integrated 24V dc ON/OFF remote electric power supply.
Adjustment on vertical axis: 15° max. Rotation on horizontal axis: 359° max. Remote power supply that must be placed in a junction box, equipped with a protruding, 400 mm cable with an M12 screw-on connector that guarantees the water tightness of the luminaire, and with a 250 mm cable for the connection to the power line.
Extra clear transparent glass.
Adjustable light intensity version available upon request.

Optic Spot 10°

Power Led: 8W - 509 lm ≠ OUTPUT 451 lm - 2700K/CRI 80 - 220÷240V / 8W - 547 lm ≠ OUTPUT 485 lm - 3000K/CRI 80 - 220÷240V / 8W - 630 lm ≠ OUTPUT 558 lm - 4000K/CRI 80 - 220÷240V

- 2700K**
● FA53405156
- 3000K**
● FA53400356
- 4000K**
● FA53400256

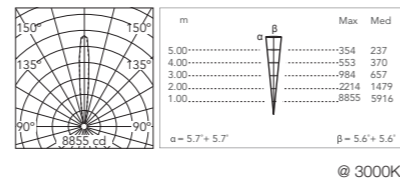

Optic Medium 24°

Power Led: 8W - 509 lm ≠ OUTPUT 472 lm - 2700K/CRI 80 - 220÷240V / 8W - 547 lm ≠ OUTPUT 507 lm - 3000K/CRI 80 - 220÷240V / 8W - 630 lm ≠ OUTPUT 583 lm - 4000K/CRI 80 - 220÷240V

- 2700K**
● FA53405256
- 3000K**
● FA53400656
- 4000K**
● FA53400556

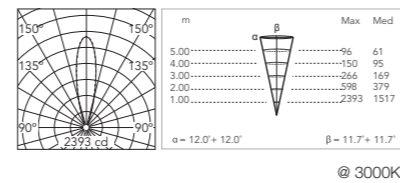

Optic Flood 50°

Power Led: 8W - 509 lm ≠ OUTPUT 433 lm - 2700K/CRI 80 - 220÷240V / 8W - 547 lm ≠ OUTPUT 466 lm - 3000K/CRI 80 - 220÷240V / 8W - 630 lm ≠ OUTPUT 536 lm - 4000K/CRI 80 - 220÷240V

- 2700K**
● FA53405356
- 3000K**
● FA53400956
- 4000K**
● FA53400856

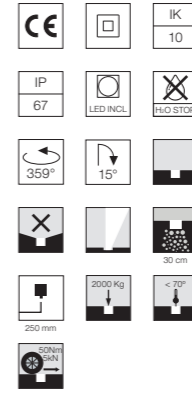
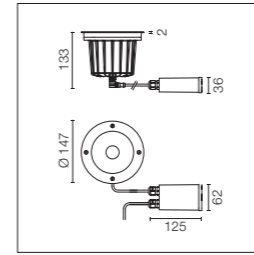
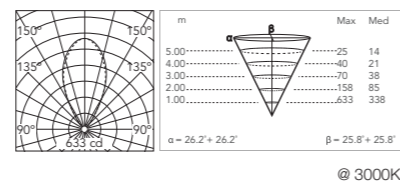

Sorgente a LED inclusa.
Alimentazione elettrica 220-240V ON/ OFF integrata.
Orientabilità asse verticale: max 15°. Rotazione asse orizzontale: max 359°. Alimentatore remoto da alloggiare in cassaforma dotato di spezzone di cavo 400mm con connettore a vite M12 a tenuta stagna all'apparecchio e di uno spezzone di cavo 250mm per il collegamento alla linea elettrica.
Vetro trasparente extrachiario.
Versione dimmerabile a richiesta.

LED light source included.
Integrated 24V dc ON/OFF remote electric power supply.
Adjustment on vertical axis: 15° max. Rotation on horizontal axis: 359° max. Remote power supply that must be placed in a junction box, equipped with a protruding, 400 mm cable with an M12 screw-on connector that guarantees the water tightness of the luminaire, and with a 250 mm cable for the connection to the power line.
Extra clear transparent glass.
Adjustable light intensity version available upon request.

Optic Asymmetric 54°x 66°

Power Led: 8W - 509 lm ≠ OUTPUT 413 lm - 2700K/CRI 80 - 220÷240V / 8W - 547 lm ≠ OUTPUT 444 lm - 3000K/CRI 80 - 220÷240V / 8W - 630 lm ≠ OUTPUT 511 lm - 4000K/CRI 80 - 220÷240V

- 2700K**
● FA53405456
- 3000K**
● FA53401256
- 4000K**
● FA53401156

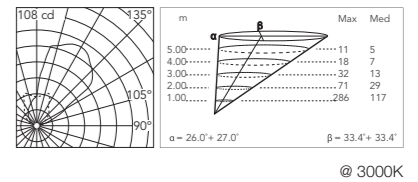

A-Rise 145 High Emission

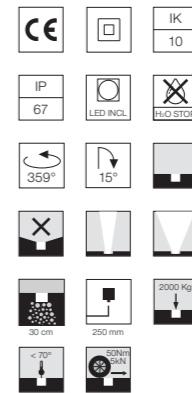
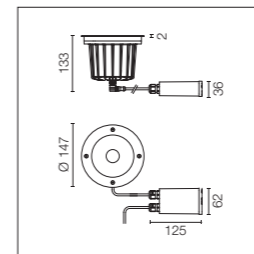

Sorgente a LED inclusa.
Alimentazione elettrica 220-240V ON/ OFF integrata.
Orientabilità asse verticale: max 15°. Rotazione asse orizzontale: max 359°. Alimentatore remoto da alloggiare in cassaforma dotato di spezzone di cavo 400mm con connettore a vite M12 a tenuta stagna all'apparecchio e di uno spezzone di cavo 250mm per il collegamento alla linea elettrica.
Vetro trasparente extrachiario.
Versione dimmerabile a richiesta.

LED light source included.
Integrated 24V dc ON/OFF remote electric power supply.
Adjustment on vertical axis: 15° max. Rotation on horizontal axis: 359° max. Remote power supply that must be placed in a junction box, equipped with a protruding, 400 mm cable with an M12 screw-on connector that guarantees the water tightness of the luminaire, and with a 250 mm cable for the connection to the power line.
Extra clear transparent glass.
Adjustable light intensity version available upon request.

Optic Spot 16°

CoB Led: 9W - 857 lm ≠ OUTPUT 518 lm - 2700K/CRI 80 - 220÷240V / 9W - 922 lm ≠ OUTPUT 557 lm - 3000K/CRI 80 - 220÷240V / 9W - 959 lm ≠ OUTPUT 579 lm - 4000K/CRI 80 - 220÷240V

- 2700K**
● FA53405556
- 3000K**
● FA53401556
- 4000K**
● FA53401456

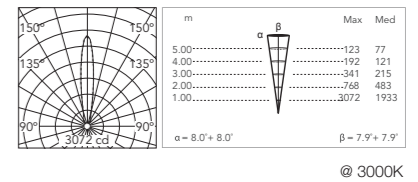







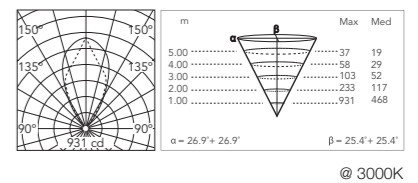

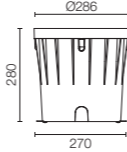

Optic Flood 50°

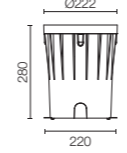
CoB Led: 9W - 857 lm ≠ OUTPUT 545 lm - 2700K/CRI 80 - 220÷240V / 9W - 922 lm ≠ OUTPUT 586 lm - 3000K/CRI 80 - 220÷240V / 9W - 959 lm ≠ OUTPUT 610 lm - 4000K/CRI 80 - 220÷240V

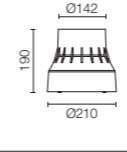
- 2700K**
● FA53405656
- 3000K**
● FA53401856
- 4000K**
● FA53401756

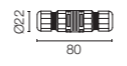

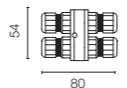
A-Rise: Accessori / Accessories

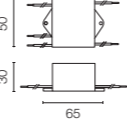

Scatola per incasso.	Box for installation.	A-Rise 290 F4599000		
Scatola per incasso.	Box for installation.	A-Rise 225 F4598000		
Scatola per incasso.	Box for installation.	A-Rise 145 F4597000		
Sistema di giunzione IP68 H ₂ O Stop anti-condensa a 2 vie 4 poli. (ø5,5÷12mm cavo).	2 way terminal block 4 poles IP68 H ₂ O Stop. (ø5,5÷12mm cable).	F990C00A000		
Sistema di giunzione IP68 H ₂ O Stop anti-condensa a 3/4 vie 4 poli. (ø5,5÷12mm cavo).	3/4 way terminal block 4 poles IP68 H ₂ O Stop. (ø5,5÷12mm cable).	F990C010000		
Dispositivo di protezione per il sovraccarico. 275Vac. Corrente massima di scarica 10KA (8/29µs). Massima corrente operativa 5A. Adatto per la connessione in serie. IP66.	Surge protection device. 275Vac. Maximum discharge current 10KA (8/20µs). Maximum operating current 5A. Suitable for series connection. IP66.	F990E00A000		

A-Rise 130 HP











Sorgente a LED inclusa a tensione di rete. Necessaria cassaforma da ordinare separatamente. Dotato di spezzone di cavo uscente in neoprene di 250 mm e sistema di giunzione H2O STOP a 2 vie e 3 poli per connessione a tenuta stagna. Vetro sabbato.

Mains voltage LED light source included. Requires a junction box to be ordered separately. The luminaire is equipped with a protruding, neoprene, 250 mm cable with an integrated 2-way, 3-pole H2O STOP connection system guaranteeing the water tightness of the connection. Frosted glass.

Optic Wide Flood 96°

Mid-Power Led: 7W - 525 lm ≠ OUTPUT 453 lm - 3000K/CRI 80 - 220-230V / 7W - 555 lm ≠ OUTPUT 479 lm - 4000K/CRI 80 - 220-230V

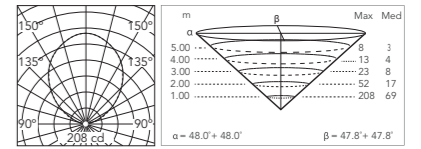
- 3000K**
● FA53000356
- 4000K**
● FA53000256



@ 4000K

A-Rise 130















Sorgente a LED inclusa a tensione di rete. Necessaria cassaforma da ordinare separatamente. Dotato di spezzone di cavo uscente in neoprene di 250 mm e sistema di giunzione H2O STOP a 2 vie e 3 poli per connessione a tenuta stagna. Vetro sabbato.

Mains voltage LED light source included. Requires a junction box to be ordered separately. The luminaire is equipped with a protruding, neoprene, 250 mm cable with an integrated 2-way, 3-pole H2O STOP connection system guaranteeing the water tightness of the connection. Frosted glass.

Optic Wide Flood 120°



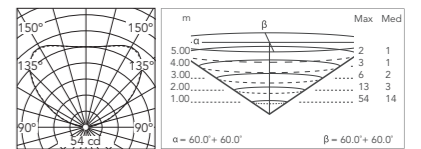

Mid-Power Led: 4W - 380 lm ≠ OUTPUT 189 lm - 3000K/CRI 80 - 220.230V / 4W - 400 lm ≠ OUTPUT 199 lm - 4000K/CRI 80 - 220.230V

- 3000K**
● FA53000856
- 4000K**
● FA53000756

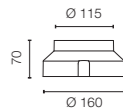

@ 4000K

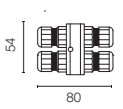
A-Rise 130: Accessori / Accessories

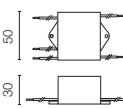
Scatola per incasso	Box for installation	FA50		
Sistema di giunzione IP68 H ₂ O Stop anti-condensa a 3/4 vie 4 poli. (ø5,5÷12mm cavo).	3/4 way terminal block 4 poles IP68 H ₂ O Stop. (ø5,5÷12mm cable).	F990C010000		
Dispositivo di protezione per il sovraccarico. 275Vac. Corrente massima di scarica 10KA (8/29µs). Massima corrente operativa 5A. Adatto per la connessione in serie. IP66.	Surge protection device. 275Vac. Maximum discharge current 10KA (8/20µs). Maximum operating current 5A. Suitable for series connection. IP66.	F990E00A000		

A-Rise 130 HP Low Voltage

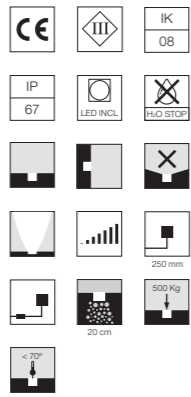
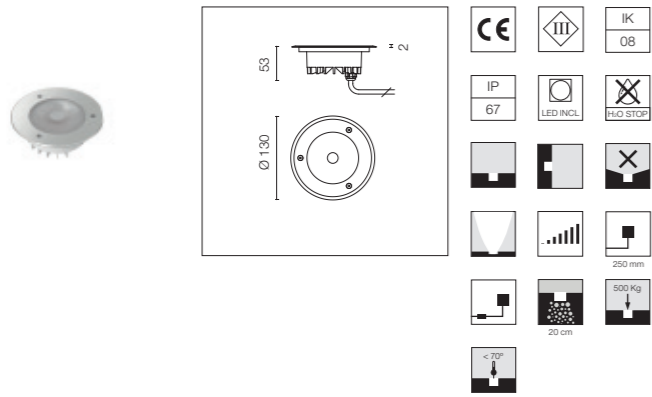

Sorgente a LED inclusa. Alimentazione elettrica remota 24V dc da ordinare separatamente, ON/ OFF e dimmerabile 1-10V o DALI. Necessaria cassaforma da ordinare separatamente. Dotato di spezzone di cavo uscente in neoprene di 250 mm con sistema integrato di giunzione H2O STOP e kit con connettori crimp e guaina termorestringente adesiva per connessione a tenuta stagna. Vetro sabbato.

LED light source included. 24V remote electric power supply to be ordered separately, ON/OFF and adjustable light intensity from 1 to 10V or DALI. Requires a junction box to be ordered separately. The luminaire is equipped with a protruding, neoprene, 250 mm cable with an integrated H2O STOP connection system and a wiring kit with crimp connectors and adhesive heat-shrink tubing guaranteeing the water tightness of the connection. Frosted glass.

Optic Wide Flood 96°

Mid-Power Led: 7,3W - 707 lm ≠ OUTPUT 380 lm - 3000K/CRI 80 - 24Vdc / 7,3W - 734 lm ≠ OUTPUT 394 lm - 4000K/CRI 80 - 24Vdc

- 3000K**
Dimmable
● FA53000656
- 4000K**
Dimmable
● FA53000556

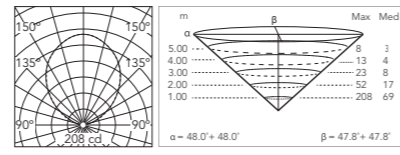

@ 4000K

* Numero massimo di apparecchi per alimentatore / Max fixtures for each power supply

Numero massimo di apparecchi per alimentatore (Vin220÷240). Dati indicativi da verificare con le specifiche condizioni di installazione.

Max fixtures for each power supply (Vin 220÷240). Data in the chart are provided as a guide only. Please verify according to your installation.

Acc. RF25747	1	Acc. RF25752	2
Acc. RF25757	1	Acc. RF25755	7
Acc. RF25750	2	Acc. RF25749	9
Acc. F990B21A000	2	Acc. RF25756	12
Acc. RF26387	2		

A-Rise 130 Low Voltage

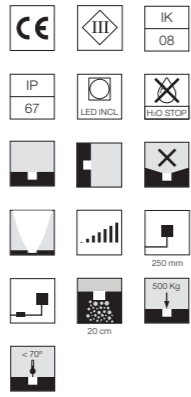
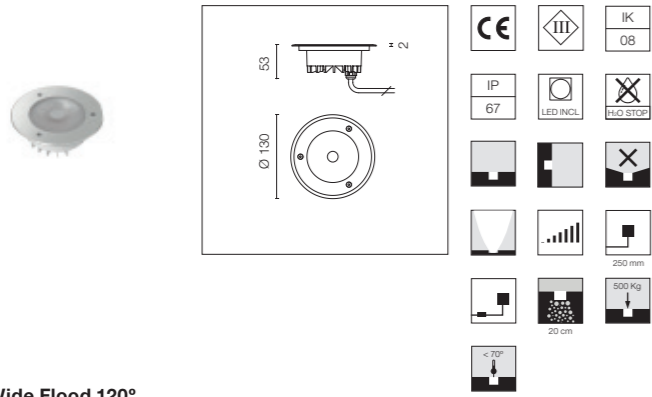

Sorgente a LED inclusa. Alimentazione elettrica remota 24V dc da ordinare separatamente, ON/ OFF e dimmerabile 1-10V o DALI. Necessaria cassaforma da ordinare separatamente. Dotato di spezzone di cavo uscente in neoprene di 250 mm con sistema integrato di giunzione H2O STOP e kit con connettori crimp e guaina termorestringente adesiva per connessione a tenuta stagna. Vetro sabbato.

LED light source included. 24V remote electric power supply to be ordered separately, ON/OFF and adjustable light intensity from 1 to 10V or DALI. Requires a junction box to be ordered separately. The luminaire is equipped with a protruding, neoprene, 250 mm cable with an integrated H2O STOP connection system and a wiring kit with crimp connectors and adhesive heat-shrink tubing guaranteeing the water tightness of the connection. Frosted glass.

Optic Wide Flood 120°

Mid-Power Led: 4W - 360 lm ≠ OUTPUT 190 lm - 3000K/CRI 80 - 24Vdc / 4W - 380 lm ≠ OUTPUT 200 lm - 4000K/CRI 80 - 24Vdc

- 3000K**
Dimmable
● FA53001056
- 4000K**
Dimmable
● FA53000956

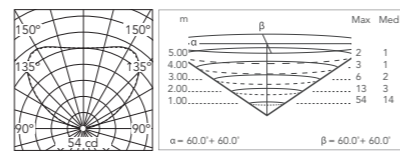

@ 4000K

* Numero massimo di apparecchi per alimentatore / Max fixtures for each power supply

Numero massimo di apparecchi per alimentatore (Vin220÷240). Dati indicativi da verificare con le specifiche condizioni di installazione.

Max fixtures for each power supply (Vin 220÷240). Data in the chart are provided as a guide only. Please verify according to your installation.

Acc. RF25747	2	Acc. RF25752	4
Acc. RF25757	2	Acc. RF25755	12
Acc. RF25750	4	Acc. RF25749	16
Acc. F990B21A000	4	Acc. RF25756	21
Acc. RF26387	4		

A-Rise 130 Low Voltage: Accessori / Accessories

Scatola per incasso	Box for installation	FA50		
Sistema di giunzione IP68 a 2 vie 2 poli. (Ø4÷6,9mm cavo).	2 way terminal block 2 poles IP68. (Ø4÷6,9mm cable).	F990C050000		
Non può essere alloggiato nella scatola per incasso.	It can't be placed in the recessed box for installation.			

A-Rise 130 Low Voltage: Driver / Drivers

Alimentatore 24V 10W / 110-240V IP20 Classe II selv.	Power supply 24V 10W / 110-240V IP20 Class II selv.	*RF25747		
Alimentatore 24V 10W / 110-240V IP67 Classe II selv.	Power supply 24V 10W / 110-240V IP67 Class II selv.	*RF25757		
Alimentatore per installazione remota 24Vdc 17W / 110-240V (15W@110V) IP20 Classe II selv.	Power supply for remote installation 24Vdc 17W / 110-240V (15W@110V) IP20 Class II selv.	*RF25750 Dimmable Push-Dim Or 1-10V See Wiring Diagram n.4. Page 668.		
Alimentatore 17W/110÷240V - 24Vdc (15W@110V) IP67 Classe II Selv.	Power supply 17W/110÷240V - 24Vdc (15W@110V) IP67 Class II Selv.	*F990B21A000 Dimmable Push-Dim Or 1-10V See Wiring Diagram n.4. Page 668.		
Alimentatore per installazione remota 24Vdc 20W / 110-240Vdc (15W@110V) IP67 Classe II selv.	Power supply for remote installation 24Vdc 20W / 110-240Vdc (15W@110V) IP67 Class II selv.	*RF26387 Dimmable DALI See Wiring Diagram n.4. Page 668.		
Alimentatore per installazione remota 24Vdc 20W / 220-240V IP67 Classe II selv.	Power supply for remote installation 24Vdc 20W / 220-240V IP67 Class II selv.	*RF25752		
Alimentatore per installazione remota 24Vdc 50W / 120-240V IP67 Classe II selv.	Power supply for remote installation 24Vdc 50W / 120-240V IP67 Class II selv.	*RF25755		
Alimentatore 24Vdc 35W / 120-270V IP67 Classe II selv.	Power supply 24Vdc 35W / 120-270V IP67 Class II selv.	F990B23AZ00		
Alimentatore per installazione remota 24Vdc 70W / 220-240V IP67 Classe II selv.	Power supply for remote installation 24Vdc 70W / 220-240V IP67 Class II selv.	*RF25749		
Alimentatore per installazione remota 24Vdc 96W / 120-240V IP67 Classe II selv.	Power supply for remote installation 24Vdc 96W / 120-240V IP67 Class II selv.	*RF25756		

A-Rise 65 Ceiling

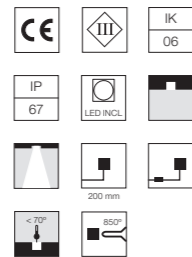
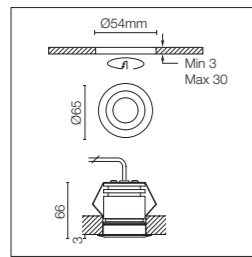

Sorgente a LED inclusa. Alimentazione elettrica remota 24V dc da ordinare separatamente. Completo di molle per installazione in cartongesso. Dotato di spezzone di cavo uscente in neoprene di 200 mm e kit con connettori crimp e guaina termorestringente adesiva per connessione a tenuta stagna. Diffusore policarbonato trasparente. Versione dimmerabile a richiesta.

LED source included. 24V dc remote electric power supply to be ordered separately. Includes a spring for plasterboard installations. The luminaire is equipped with a protruding, neoprene, 200 mm cable and a wiring kit with crimp connectors and adhesive heat-shrink tubing guaranteeing the water tightness of the connection. Transparent polycarbonate diffuser. Adjustable light intensity version available upon request.

Optic Spot 10°

Power Led: 3,4W - 199 lm ≠ OUTPUT 138 lm - 2700K/CRI 80 - 24Vdc / 3,4W - 215 lm ≠ OUTPUT 149 lm - 3000K/CRI 80 - 24Vdc / 3,4W - 224 lm ≠ OUTPUT 155 lm - 4000K/CRI 80 - 24Vdc

- 2700K**
● FA51820556
- 3000K**
● FA51800656
- 4000K**
● FA51800556

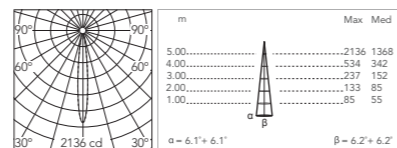

@ 3000K

Optic Medium 30°

Power Led: 3,4W - 199 lm ≠ OUTPUT 121 lm - 2700K/CRI 80 - 24Vdc / 3,4W - 215 lm ≠ OUTPUT 131 lm - 3000K/CRI 80 - 24Vdc / 3,4W - 224 lm ≠ OUTPUT 136 lm - 4000K/CRI 80 - 24Vdc

- 2700K**
● FA51820856
- 3000K**
● FA51800956
- 4000K**
● FA51800856

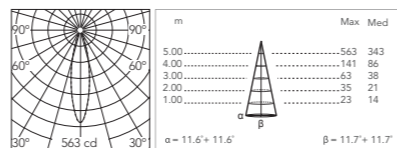

@ 3000K

A-Rise 65

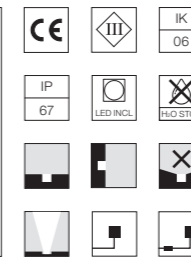
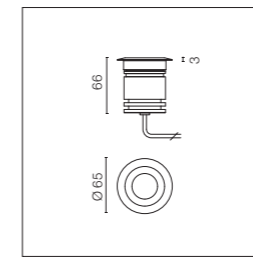

Sorgente a LED inclusa. Alimentazione elettrica remota 24V dc da ordinare separatamente. Necessaria cassaforma da ordinare separatamente. Dotato di spezzone di cavo uscente in neoprene di 200 mm con sistema integrato di giunzione H2O STOP e kit con connettori crimp e guaina termorestringente adesiva per connessione a tenuta stagna. Diffusore policarbonato trasparente. Versione dimmerabile a richiesta.

LED source included. 24V dc remote electric power supply to be ordered separately. Requires a junction box to be ordered separately. The luminaire is equipped with a protruding, neoprene, 200 mm cable with an integrated H2O STOP connection system and a wiring kit with crimp connectors and adhesive heat-shrink tubing guaranteeing the water tightness of the connection. Transparent polycarbonate diffuser. Adjustable light intensity version available upon request.

Optic Spot 10°

Power Led: 3,4W - 199 lm ≠ OUTPUT 138 lm - 2700K/CRI 80 - 24Vdc / 3,4W - 215 lm ≠ OUTPUT 149 lm - 3000K/CRI 80 - 24Vdc / 3,4W - 224 lm ≠ OUTPUT 155 lm - 4000K/CRI 80 - 24Vdc

- 2700K**
● FA51820256
- 3000K**
● FA51800356
- 4000K**
● FA51800256

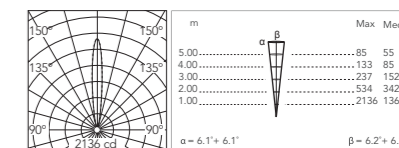

@ 3000K

Optic Medium 30°

Power Led: 3,4W - 199 lm ≠ OUTPUT 121 lm - 2700K/CRI 80 - 24Vdc / 3,4W - 215 lm ≠ OUTPUT 131 lm - 3000K/CRI 80 - 24Vdc / 3,4W - 224 lm ≠ OUTPUT 136 lm - 4000K/CRI 80 - 24Vdc

- 2700K**
● FA51821256
- 3000K**
● FA51801356
- 4000K**
● FA51801256

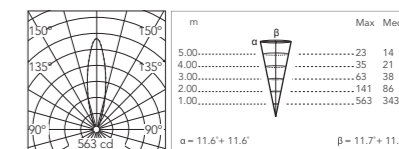

@ 3000K

A-Rise 65 Opal

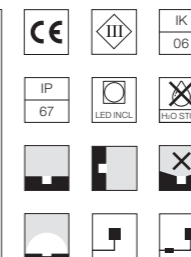
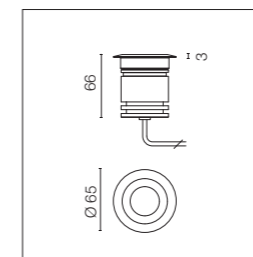

Sorgente la LED inclusa. Alimentazione elettrica remota 24V dc da ordinare separatamente. Necessaria cassaforma da ordinare separatamente. Dotato di spezzone di cavo uscente in neoprene di 200 mm e kit con connettori crimp e guaina termorestringente adesiva per connessione a tenuta stagna. Diffusore policarbonato opale. Versione dimmerabile a richiesta.

LED light source included. 24V dc remote electric power supply to be ordered separately. Requires a junction box to be ordered separately. The luminaire is equipped with a protruding, neoprene, 200 mm cable and a wiring kit with crimp connectors and adhesive heat-shrink tubing guaranteeing the water tightness of the connection. Opal polycarbonate diffuser. Adjustable light intensity version available upon request.

Optic Wide Flood 100°

Power Led: 3,4W - 169 lm ≠ OUTPUT 20 lm - 2700K/CRI 80 - 24Vdc / 3,4W - 182 lm ≠ OUTPUT 22 lm - 3000K/CRI 80 - 24Vdc / 3,4W - 198 lm ≠ OUTPUT 24 lm - 4000K/CRI 80 - 24Vdc

- 2700K**
● FA51823456
- 3000K**
● FA51803556
- 4000K**
● FA51803456

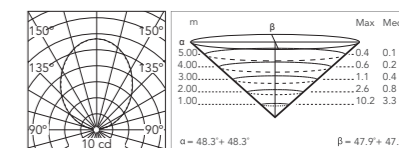

@ 4000K

A-Rise 65 HP Ceiling

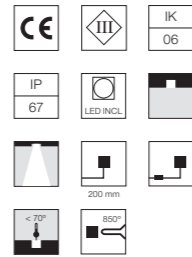
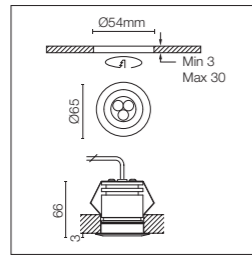

Sorgente a LED inclusa. Alimentazione elettrica remota 24V dc da ordinare separatamente. Completo di molle per installazione in cartongesso. Dotato di spezzone di cavo uscente in neoprene di 200 mm e kit con connettori crimp e guaina termorestringente adesiva per connessione a tenuta stagna. Diffusore policarbonato trasparente. Versione dimmerabile a richiesta.

LED source included. 24V dc remote electric power supply to be ordered separately. Includes a spring for plasterboard installations. The luminaire is equipped with a protruding, neoprene, 200 mm cable and a wiring kit with crimp connectors and adhesive heat-shrink tubing guaranteeing the water tightness of the connection. Transparent polycarbonate diffuser. Adjustable light intensity version available upon request.

Optic Spot 10°

Power Led: 4,5W - 331 lm ≠ OUTPUT 246 lm - 2700K/CRI 80 - 24Vdc / 4,5W - 359 lm ≠ OUTPUT 267 lm - 3000K/CRI 80 - 24Vdc / 4,5W - 373 lm ≠ OUTPUT 277 lm - 4000K/CRI 80 - 24Vdc

- 2700K**
● FA51821556
- 3000K**
● FA51801656
- 4000K**
● FA51801556

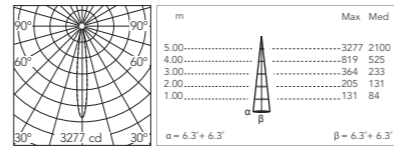

@ 3000K

Optic Medium 30°

Power Led: 4,5W - 331 lm ≠ OUTPUT 218 lm - 2700K/CRI 80 - 24Vdc / 4,5W - 359 lm ≠ OUTPUT 236 lm - 3000K/CRI 80 - 24Vdc / 4,5W - 373 lm ≠ OUTPUT 245 lm - 4000K/CRI 80 - 24Vdc

- 2700K**
● FA51822556
- 3000K**
● FA51802656
- 4000K**
● FA51802556

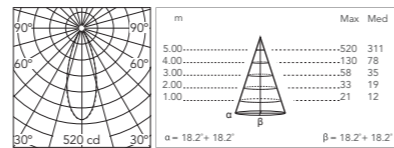

@ 3000K

A-Rise 65 HP

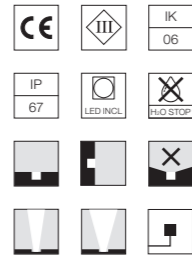
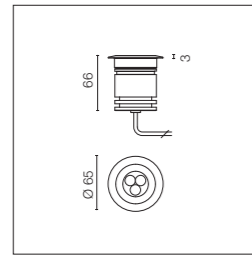

Sorgente a LED inclusa. Alimentazione elettrica remota 24V dc da ordinare separatamente. Necessaria cassaforma da ordinare separatamente. Dotato di spezzone di cavo uscente in neoprene di 200 mm con sistema integrato di giunzione H2O STOP e kit con connettori crimp e guaina termorestringente adesiva per connessione a tenuta stagna. Diffusore policarbonato trasparente. Versione dimmerabile a richiesta.

LED source included. 24V dc remote electric power supply to be ordered separately. Requires a junction box to be ordered separately. The luminaire is equipped with a protruding, neoprene, 200 mm cable with an integrated H2O STOP connection system and a wiring kit with crimp connectors and adhesive heat-shrink tubing guaranteeing the water tightness of the connection. Transparent polycarbonate diffuser. Adjustable light intensity version available upon request.

Optic Spot 10°

Power Led: 4,5W - 331 lm ≠ OUTPUT 246 lm - 2700K/CRI 80 - 24Vdc / 4,5W - 359 lm ≠ OUTPUT 267 lm - 3000K/CRI 80 - 24Vdc / 4,5W - 373 lm ≠ OUTPUT 277 lm - 4000K/CRI 80 - 24Vdc

- 2700K**
● FA51822256
- 3000K**
● FA51802356
- 4000K**
● FA51802256

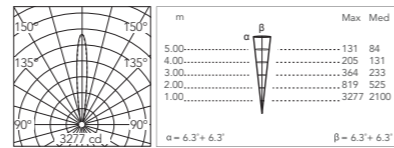

@ 3000K

Optic Medium 30°

Power Led: 4,5W - 331 lm ≠ OUTPUT 218 lm - 2700K/CRI 80 - 24Vdc / 4,5W - 359 lm ≠ OUTPUT 236 lm - 3000K/CRI 80 - 24Vdc / 4,5W - 373 lm ≠ OUTPUT 245 lm - 4000K/CRI 80 - 24Vdc

- 2700K**
● FA51823256
- 3000K**
● FA51803356
- 4000K**
● FA51803256

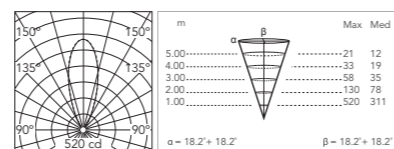

@ 3000K

A-Rise 65: Accessori / Accessories

Scatola per incasso.	Box for installation.	F004Z0K0000		
Sistema di giunzione IP68 a 2 vie 2 poli. (Ø4÷6,9mm cavo).	2 way terminal block 2 poles IP68. (Ø4÷6,9mm cable).	F990C050000		
Non può essere alloggiato nella scatola per incasso.	It can't be placed in the recessed box for installation.			

A-Rise 65: Driver 24Vdc / Drivers 24Vdc

Alimentatore doppia funzione Vout 24Vdc: 8W/100÷240V Iout 350mA: 6x1W/100÷240V IP20 Classe II Selv Eq.	Power supply dual function Vout 24Vdc: 8W/100÷240V Iout 350mA: 6x1W/100÷240V IP20 Class II Selv Eq.	*RF25754		
Alimentatore doppia funzione Vout 24Vdc: 8W/100÷240V Iout 350mA: 6x1W/100÷240V IP65 Classe II Selv Eq.	Power supply dual function Vout 24Vdc: 8W/100÷240V Iout 350mA: 6x1W/100÷240V IP65 Class II Selv Eq.	*RF25748		
Alimentatore per installazione remota 24Vdc 10W / 110-240V IP20 Classe II selv.	Power supply for remote installation 24Vdc 10W / 110-240V IP20 Class II selv.	*RF25747		
Alimentatore 10W/110÷240V - 24Vdc IP67 Classe II Selv.	Power supply 10W/110÷240V - 24Vdc IP67 Class II Selv.	*RF25757		
Alimentatore 24Vdc 35W / 120-270V IP67 Classe II selv.	Power supply 24Vdc 35W / 120-270V IP67 Class II selv.	F990B23AZ00		
Alimentatore per installazione remota 24Vdc 50W / 120-240V IP67 Classe II selv.	Power supply for remote installation 24Vdc 50W / 120-240V IP67 Class II selv.	*RF25755		
Alimentatore per installazione remota 24Vdc 70W / 220-240V IP67 Classe II selv.	Power supply for remote installation 24Vdc 70W / 220-240V IP67 Class II selv.	*RF25749		

* Numero massimo di apparecchi per alimentatore / Max fixtures for each power supply

Numero massimo di apparecchi per alimentatore (V _{in} 220÷240). Dati indicativi da verificare con le specifiche condizioni di installazione.	Max fixtures for each power supply (V _{in} 220÷240). Data in the chart are provided as a guide only. Please verify according to your installation.	A-RISE 65	A-RISE 65 HP
Acc. RF25754	1	Acc. RF25754	1
Acc. RF25748	1	Acc. RF25748	1
Acc. RF25747	2	Acc. RF25747	2
Acc. RF25757	2	Acc. RF25757	2
Acc. RF25755	9	Acc. RF25755	7
Acc. RF25749	17	Acc. RF25749	14

A-Rise 49 Ceiling

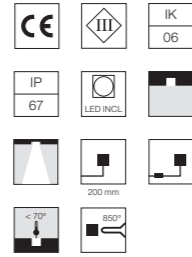
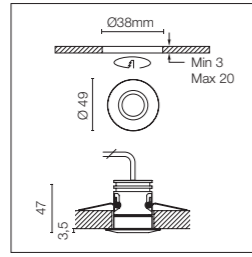

Sorgente a LED inclusa. Alimentazione elettrica remota 24V dc da ordinare separatamente. Completo di molle per installazione in cartongesso. Dotato di spezzone di cavo uscente in neoprene di 200 mm e kit con connettori crimp e guaina termorestringente adesiva per connessione a tenuta stagna. Diffusore policarbonato trasparente. Versione dimmerabile a richiesta.

LED source included. 24V dc remote electric power supply to be ordered separately. Includes a spring for plasterboard installations. The luminaire is equipped with a protruding, neoprene, 200 mm cable and a wiring kit with crimp connectors and adhesive heat-shrink tubing guaranteeing the water tightness of the connection. Transparent polycarbonate diffuser. Adjustable light intensity version available upon request.

Optic Spot 15°

Power Led: 2,3W - 144 lm ≠ OUTPUT 106 lm - 2700K/CRI 80 - 12÷24Vdc / 2,3W - 155 lm ≠ OUTPUT 115 lm - 3000K/CRI 80 - 12÷24Vdc / 2,3W - 161 lm ≠ OUTPUT 119 lm - 4000K/CRI 80 - 12÷24Vdc

- 2700K** ● FA51711556 **3000K** ● FA51711356 **4000K** ● FA51711256

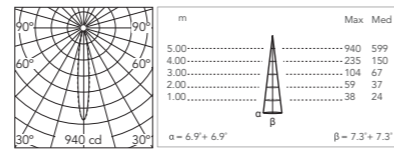

@ 3000K

Optic Medium 45°

Power Led: 2,3W - 144 lm ≠ OUTPUT 97 lm - 2700K/CRI 80 - 12÷24Vdc / 2,3W - 155 lm ≠ OUTPUT 105 lm - 3000K/CRI 80 - 12÷24Vdc / 2,3W - 161 lm ≠ OUTPUT 109 lm - 4000K/CRI 80 - 12÷24Vdc

- 2700K** ● FA51712556 **3000K** ● FA51712356 **4000K** ● FA51712256

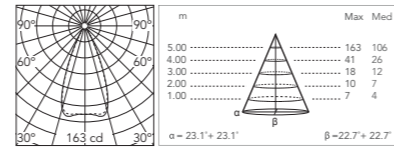

@ 3000K

A-Rise 49

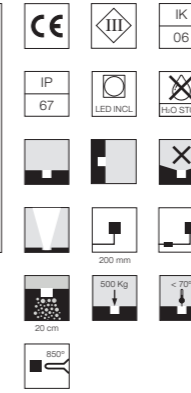
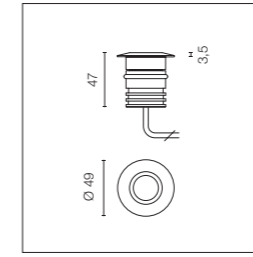

Sorgente a LED inclusa. Alimentazione elettrica remota 24V dc da ordinare separatamente. Necessaria cassaforma da ordinare separatamente. Dotato di spezzone di cavo uscente in neoprene di 200 mm con sistema integrato di giunzione H2O STOP e kit con connettori crimp e guaina termorestringente adesiva per connessione a tenuta stagna. Diffusore policarbonato trasparente. Versione dimmerabile a richiesta.

LED source included. 24V dc remote electric power supply to be ordered separately. Requires a junction box to be ordered separately. The luminaire is equipped with a protruding, neoprene, 200 mm cable with an integrated H2O STOP connection system and a wiring kit with crimp connectors and adhesive heat-shrink tubing guaranteeing the water tightness of the connection. Transparent polycarbonate diffuser. Adjustable light intensity version available upon request.

Optic Spot 15°

Power Led: 2,3W - 144 lm ≠ OUTPUT 106 lm - 2700K/CRI 80 - 12÷24Vdc / 2,3W - 155 lm ≠ OUTPUT 115 lm - 3000K/CRI 80 - 12÷24Vdc / 2,3W - 161 lm ≠ OUTPUT 119 lm - 4000K/CRI 80 - 12÷24Vdc

- 2700K** ● FA51700556 **3000K** ● FA51700356 **4000K** ● FA51700256

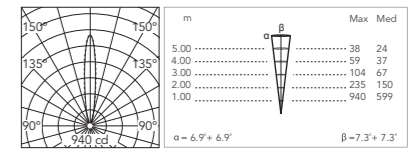

@ 3000K

Optic Medium 45°

Power Led: 2,3W - 144 lm ≠ OUTPUT 97 lm - 2700K/CRI 80 - 12÷24Vdc / 2,3W - 155 lm ≠ OUTPUT 105 lm - 3000K/CRI 80 - 12÷24Vdc / 2,3W - 161 lm ≠ OUTPUT 109 lm - 4000K/CRI 80 - 12÷24Vdc

- 2700K** ● FA51701656 **3000K** ● FA51701356 **4000K** ● FA51701256

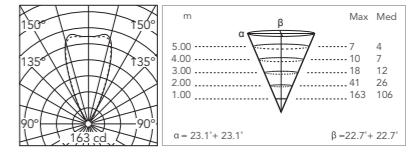

@ 3000K

A-Rise 49 Opal

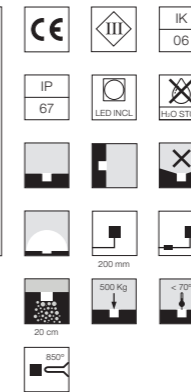
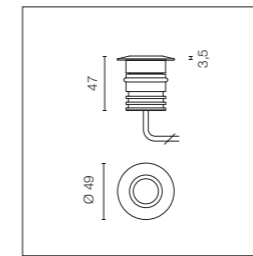

Sorgente la LED inclusa. Alimentazione elettrica remota 24V dc da ordinare separatamente. Necessaria cassaforma da ordinare separatamente. Dotato di spezzone di cavo uscente in neoprene di 200 mm e kit con connettori crimp e guaina termorestringente adesiva per connessione a tenuta stagna. Diffusore policarbonato opale. Versione dimmerabile a richiesta.

LED light source included. 24V dc remote electric power supply to be ordered separately. Requires a junction box to be ordered separately. The luminaire is equipped with a protruding, neoprene, 200 mm cable and a wiring kit with crimp connectors and adhesive heat-shrink tubing guaranteeing the water tightness of the connection. Opal polycarbonate diffuser. Adjustable light intensity version available upon request.

Optic Wide Flood 100°

Power Led: 2,3W - 139 lm ≠ OUTPUT 16 lm - 2700K/CRI 80 - 12÷24Vdc / 2,3W - 149 lm ≠ OUTPUT 17 lm - 3000K/CRI 80 - 12÷24Vdc / 2,3W - 162 lm ≠ OUTPUT 18 lm - 4000K/CRI 80 - 12÷24Vdc

- 2700K** ● FA51701756 **3000K** ● FA51701556 **4000K** ● FA51701456

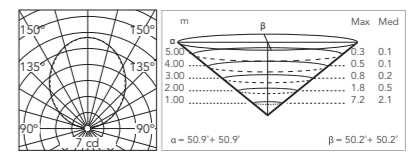









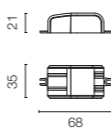

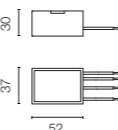

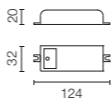
@ 4000K

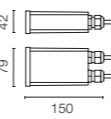
A-Rise 49: Accessori / Accessories

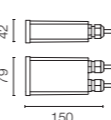
Scatola per incasso.	Box for installation.	F004Z0J0000		
Sistema di giunzione IP68 a 2 vie 2 poli. (Ø4÷6,9mm cavo).	2 way terminal block 2 poles IP68. (Ø4÷6,9mm cable).	F990C050000		
Non può essere alloggiato nella scatola per incasso.	It can't be placed in the recessed box for installation.			

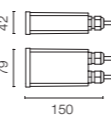
A-Rise 49: Driver / Drivers 24Vdc

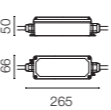
Alimentatore doppia funzione Vout 24Vdc: 8W/100÷240V Iout 350ma: 6x1W/100÷240V IP20 Classe II Selv Eq.	Power supply dual function Vout 24Vdc: 8W/100÷240V Iout 350ma: 6x1W/100÷240V IP20 Class II Selv Eq.	*RF25754		
Alimentatore doppia funzione Vout 24Vdc: 8W/100÷240V Iout 350mA: 6x1W/100÷240V IP65 Classe II Selv Eq.	Power supply dual function Vout 24Vdc: 8W/100÷240V Iout 350mA: 6x1W/100÷240V IP65 Class II Selv Eq.	*RF25748		
Alimentatore per installazione remota 24Vdc 10W / 110-240V IP20 Classe II selv.	Power supply for remote installation 24Vdc 10W /110-240V IP20 Class II selv.	*RF25747		
Alimentatore 10W/110÷240V - 24Vdc IP67 Classe II Selv.	Power supply 10W/110÷240V - 24Vdc IP67 Class II Selv.	*RF25757		
Alimentatore per installazione remota 24Vdc 20W / 220-240V IP67 Classe II selv.	Power supply for remote installation 24Vdc 20W / 220-240V IP67 Class II selv.	*RF25752		
Alimentatore 24Vdc 35W / 120-270V IP67 Classe II selv.	Power supply 24Vdc 35W / 120-270V IP67 Class II selv.	F990B23AZ00		
Alimentatore per installazione remota 24Vdc 50W / 120-240V IP67 Classe II selv.	Power supply for remote installation 24Vdc 50W / 120-240V IP67 Class II selv.	*RF25755		
Alimentatore per installazione remota 24Vdc 70W / 220-240V IP67 Classe II selv.	Power supply for remote installation 24Vdc 70W / 220-240V IP67 Class II selv.	*RF25749		

* Numero massimo di apparecchi per alimentatore / Max fixtures for each power supply

Numero massimo di apparecchi per alimentatore (Vin220÷240). Dati indicativi da verificare con le specifiche condizioni di installazione.

Max fixtures for each power supply (Vin 220÷240). Data in the chart are provided as a guide only. Please verify according to your installation.

Acc. RF25754	1
Acc. RF25748	1
Acc. RF25747	4
Acc. RF25757	4

Acc. RF25752	5
Acc. RF25755	14
Acc. RF25749	29

Gobi



Gobi



Famiglia / Family

Gobi 180



Power Led
up to 12W
up to 256 lm - 2700K/CRI 80
up to 276 lm - 3000K/CRI 80
up to 296 lm - 4000K/CRI 80
* Net lumen output

Gobi 130



Power Led
up to 7W
up to 140 lm - 2700K/CRI 80
up to 152 lm - 3000K/CRI 80
up to 164 lm - 4000K/CRI 80
* Net lumen output

Gobi 65

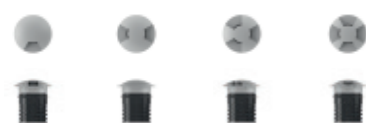

Power Led
up to 3,4W
up to 60 lm - 2700K/CRI 80
up to 64 lm - 3000K/CRI 80
up to 72 lm - 4000K/CRI 80
* Net lumen output

Gobi 65 Wall Path



Power Led
up to 3,4W
up to 47 lm - 2700K/CRI 80
up to 50 lm - 3000K/CRI 80
up to 54 lm - 4000K/CRI 80
* Net lumen output

Gobi 49



Power Led
up to 2,3W
up to 40 lm - 2700K/CRI 80
up to 44 lm - 3000K/CRI 80
up to 48 lm - 4000K/CRI 80
* Net lumen output

Gobi 49 Wall Path



Power Led
up to 2,3W
up to 36 lm - 2700K/CRI 80
up to 39 lm - 3000K/CRI 80
up to 42 lm - 4000K/CRI 80
* Net lumen output

Colori / Colours



01 White



06 Grey



12 Forest Green



18 Deep Brown



30 Black



33 Anthracite



56 Matt Stainless Steel*

* Solo per versioni Gobi 65 e Gobi 49. / Only for Gobi 65 and Gobi 49 versions.

Descrizione / Description

Famiglia completa di apparecchi segnapasso ad incasso a pavimento con sorgente luminosa a LED ad emissione radente. Disponibili in differenti tagli dimensionali e molteplici fasci di apertura direzionati. Le viterie di fissaggio sono in acciaio inox AISI 316L. L'installazione richiede una cassaforma da incasso da ordinare separatamente. È necessario garantire un livello adeguato di materiale drenante sotto la cassaforma o fornire un sistema di scarico per evitare il ristagno di acqua. Per garantire la tenuta del pressacavo è necessario utilizzare cavi elettrici flessibili idonei all'impiego in ambienti esterni.

Gobi

Apparecchio ad incasso a terra calpestabile e carrabile, disponibile in due dimensioni di diametro e in tre fasci di apertura: monodirezionale, bidirezionale e omnidirezionale. La posizione parallela della sorgente luminosa alla superficie di appoggio permette di sfruttare al massimo la componente diretta dell'emissione luminosa. Corpo dell'apparecchio e dissipatore realizzato in alluminio pressofuso EN AB-47100 a basso contenuto di rame, rivestito con doppio strato di vernice ad alta resistenza alla corrosione. Vetro borosilicato trasparente. L'apparecchio è dotato di un connettore a vite M12 a tenuta stagna che fornisce isolamento ottimale contro la penetrazione di acqua e rapido collegamento con l'unità di cablaggio. Nella versione a 230V l'alimentatore è in dotazione con l'apparecchio come un kit IP67 remoto da alloggiare nella cassaforma da incasso, nella versione a 24V dc è provvisto di uno spezzone di cavo con connettore a vite per il collegamento elettrico all'alimentatore remoto. Disponibili due versioni di casseforme, la versione standard in materiale plastico e la versione in metallo ad alta resistenza per aree ad alto flusso veicolare.

Gobi 49 / Gobi 65

Apparecchi ad incasso a terra calpestabili, disponibili in due dimensioni di diametro e in quattro fasci di apertura: un fascio, due fasci, tre fasci e quattro fasci. Corpo dell'apparecchio in alluminio tornito lega EN AW 6060 con trattamento di anodizzazione ad alta resistenza alla corrosione. Cover esterna in acciaio inox AISI 316L pallinato. Diffusore in policarbonato trasparente. Apparecchio in 24V dc, necessita di alimentatore remoto da ordinare separatamente.

Gobi 49 Wall / Gobi 65 Wall

Apparecchi ad incasso a parete segnapasso, disponibili in due dimensioni di diametro e con fascio di apertura 180° direzionato verso il pavimento. Corpo dell'apparecchio in alluminio tornito lega EN AW 6060 con trattamento di anodizzazione ad alta resistenza alla corrosione. Cover esterna in acciaio inox AISI 316L pallinato. Diffusore in policarbonato trasparente. Apparecchio in 24V dc, necessita di alimentatore remoto da ordinare separatamente.

Complete family of ground-recessed path lights, with flush-emitting LED source. Available in different dimensions and several adjustable beam angles. The fixing screws are made of AISI 316L stainless steel. Requires a specific junction box to be ordered separately. To avoid water stagnation, it is necessary to insulate the lower part of the box with a layer of drainage material or other drainage system. In order to guarantee the preservation of the cable guide, it is recommended to use flexible electric cables specifically designed for outdoor use.

Gobi

Ground recessed and walk-over luminaire, available in two different diameters and three beam angles: monodirectional, bidirectional and omnidirectional. The position of the light source, parallel to the supporting surface, allows the direct component of the light emission to be exploited to the maximum. EN AB-47100 die-cast aluminium body (with low copper content), coated with a double layer of highly corrosion-resistant paint. Transparent borosilicate glass. Equipped with an M12 screw-on connector that prevents water infiltration and guarantees a quick connection to the wiring unit. 230V versions include the power supply unit and a remote IP67 kit to be installed in the junction box for recessing. The 24 V dc version is equipped with a cable and a screw connector for the connection to the remote power supply. The junction box is available in two versions: the standard version made of plastic and the heavy duty metal version, suitable for areas with high vehicular flow.

Gobi 49 / Gobi 65

Ground recessed and walk-over luminaire, available in two different diameters and four beam angles: one beam, two beams, three beams and four beams. Structure in turned aluminium, EN AW 6060 alloy, with an anodized treatment for better resistance to corrosion. The external structure is covered in AISI 316L shot-blasted stainless steel. Transparent polycarbonate diffuser. The 24 V dc luminaire is powered by a remote power supply to be ordered separately.

Gobi 49 Wall / Gobi 65 Wall

Wall-recessed path light, available in two different diameters and with a 180° beam angle directed towards the floor. Structure in turned aluminium, EN AW 6060 alloy, with an anodized treatment for better resistance to corrosion. The external structure is covered in AISI 316L shot-blasted stainless steel. Transparent polycarbonate diffuser. The 24 V dc luminaire is powered by a remote power supply to be ordered separately.

Gobi 180 Mono

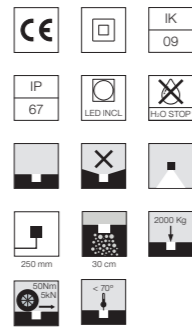
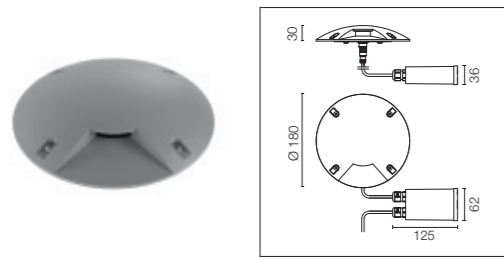

Sorgente a LED inclusa.
Alimentazione elettrica 220-240V ON/ OFF integrata.
Necessaria cassaforma da ordinare separatamente.
Alimentatore dotato di spezzone di cavo di 400mm con connettore a vite M12 a tenuta stagna verso l'apparecchio e spezzone di cavo di 300mm per collegamento alla linea elettrica.
Versione dimmerabile a richiesta.

LED light source included.
Integrated electric power supply 220-240V ON/OFF.
Requires a junction box to be ordered separately.
The luminaire is equipped with a protruding, neoprene, 400 mm cable with an M12 watertight screw-on connector towards the luminaire, and with a 300 mm cable for the connection to the power line.
Adjustable light intensity version available upon request.

Power Led: 5W - 233 lm ≠ OUTPUT 64 lm - 2700K/CRI 80 - 220÷240V / 5W - 250 lm ≠ OUTPUT 69 lm - 3000K/CRI 80 - 220÷240V / 5W - 266 lm ≠ OUTPUT 74 lm - 4000K/CRI 80 - 220÷240V

- | | | |
|--------------|--------------|--------------|
| 2700K | 3000K | 4000K |
| ○ FA53504701 | ○ FA53501201 | ○ FA53501101 |
| ● FA53504706 | ● FA53501206 | ● FA53501106 |
| ● FA53504712 | ● FA53501212 | ● FA53501112 |
| ● FA53504718 | ● FA53501218 | ● FA53501118 |
| ● FA53504730 | ● FA53501230 | ● FA53501130 |
| ● FA53504733 | ● FA53501233 | ● FA53501133 |

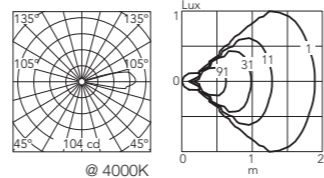

Gobi 180 Mono Low Voltage

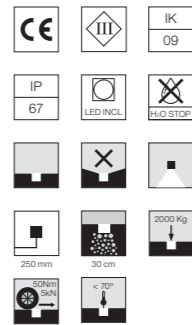
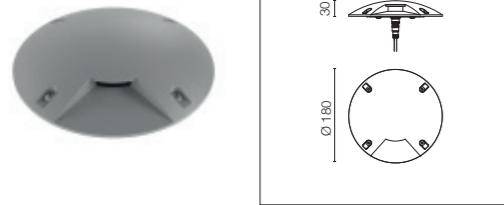

Sorgente a LED inclusa.
Alimentazione elettrica 220-240V ON/ OFF integrata.
Necessaria cassaforma da ordinare separatamente.
Alimentatore dotato di spezzone di cavo di 400mm con connettore a vite M12 a tenuta stagna verso l'apparecchio e spezzone di cavo di 300mm per collegamento alla linea elettrica.
Versione dimmerabile a richiesta.

LED light source included.
Integrated electric power supply 220-240V ON/OFF.
Requires a junction box to be ordered separately.
The luminaire is equipped with a protruding, neoprene, 400 mm cable with an M12 watertight screw-on connector towards the luminaire, and with a 300 mm cable for the connection to the power line.
Adjustable light intensity version available upon request.

Power Led: 3,4W - 233 lm ≠ OUTPUT 64 lm - 2700K/CRI 80 - 24dc / 3,4W - 250 lm ≠ OUTPUT 69 lm - 3000K/CRI 80 - 24dc / 3,4W - 266 lm ≠ OUTPUT 74 lm - 4000K/CRI 80 - 24dc

- | | | |
|--------------|--------------|--------------|
| 2700K | 3000K | 4000K |
| ○ FA53504801 | ○ FA53503001 | ○ FA53502901 |
| ● FA53504806 | ● FA53503006 | ● FA53502906 |
| ● FA53504812 | ● FA53503012 | ● FA53502912 |
| ● FA53504818 | ● FA53503018 | ● FA53502918 |
| ● FA53504830 | ● FA53503030 | ● FA53502930 |
| ● FA53504833 | ● FA53503033 | ● FA53502933 |

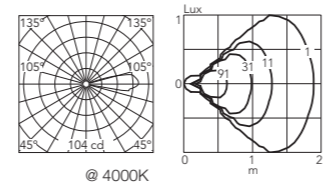

* Numero massimo di apparecchi per alimentatore / Maximum number of luminaires per power supply.

Numero massimo di apparecchi per alimentatore (Vin220÷240). Dati indicativi da verificare con le specifiche condizioni di installazione.	Maximum number of luminaires per power supply. (220÷240 V). These data must be checked taking into account the specific installation conditions.	Acc. RF25752	3
		Acc. RF25755	8
		Acc. RF25749	16

Gobi 130 Mono

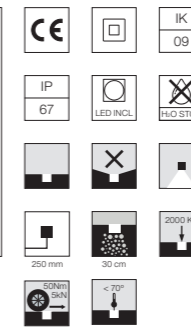
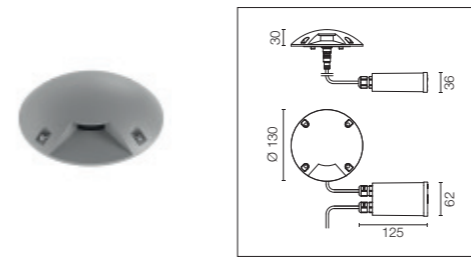

Sorgente a LED inclusa.
Alimentazione elettrica 220-240V ON/ OFF integrata.
Necessaria cassaforma da ordinare separatamente.
Alimentatore dotato di spezzone di cavo di 400mm con connettore a vite M12 a tenuta stagna verso l'apparecchio e spezzone di cavo di 300mm per collegamento alla linea elettrica.
Versione dimmerabile a richiesta.

LED light source included.
Integrated electric power supply 220-240V ON/OFF.
Requires a junction box to be ordered separately.
The luminaire is equipped with a protruding, neoprene, 400 mm cable with an M12 watertight screw-on connector towards the luminaire, and with a 300 mm cable for the connection to the power line.
Adjustable light intensity version available upon request.

Power Led: 4W - 129 lm ≠ OUTPUT 35 lm - 2700K/CRI 80 - 220÷240V / 4W - 139 lm ≠ OUTPUT 38 lm - 3000K/CRI 80 - 220÷240V / 4W - 148 lm ≠ OUTPUT 41 lm - 4000K/CRI 80 - 220÷240V

- | | | |
|--------------|--------------|--------------|
| 2700K | 3000K | 4000K |
| ○ FA53504101 | ○ FA53500301 | ○ FA53500201 |
| ● FA53504106 | ● FA53500306 | ● FA53500206 |
| ● FA53504112 | ● FA53500312 | ● FA53500212 |
| ● FA53504118 | ● FA53500318 | ● FA53500218 |
| ● FA53504130 | ● FA53500330 | ● FA53500230 |
| ● FA53504133 | ● FA53500333 | ● FA53500233 |

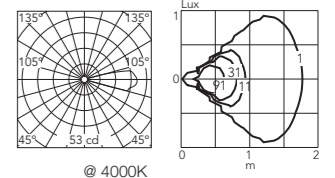

Gobi 130 Mono Low Voltage

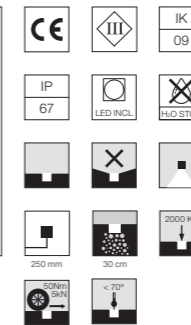
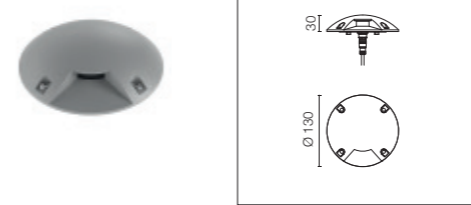

Sorgente a LED inclusa.
Alimentazione elettrica 220-240V ON/ OFF integrata.
Necessaria cassaforma da ordinare separatamente.
Alimentatore dotato di spezzone di cavo di 400mm con connettore a vite M12 a tenuta stagna verso l'apparecchio e spezzone di cavo di 300mm per collegamento alla linea elettrica.
Versione dimmerabile a richiesta.

LED light source included.
Integrated electric power supply 220-240V ON/OFF.
Requires a junction box to be ordered separately.
The luminaire is equipped with a protruding, neoprene, 400 mm cable with an M12 watertight screw-on connector towards the luminaire, and with a 300 mm cable for the connection to the power line.
Adjustable light intensity version available upon request.

Power Led: 1,9W - 129 lm ≠ OUTPUT 35 lm - 2700K/CRI 80 - 24dc / 1,9W - 139 lm ≠ OUTPUT 38 lm - 3000K/CRI 80 - 24dc / 1,9W - 148 lm ≠ OUTPUT 41 lm - 4000K/CRI 80 - 24dc

- | | | |
|--------------|--------------|--------------|
| 2700K | 3000K | 4000K |
| ○ FA53504201 | ○ FA53502101 | ○ FA53502001 |
| ● FA53504206 | ● FA53502106 | ● FA53502006 |
| ● FA53504212 | ● FA53502112 | ● FA53502012 |
| ● FA53504218 | ● FA53502118 | ● FA53502018 |
| ● FA53504230 | ● FA53502130 | ● FA53502030 |
| ● FA53504233 | ● FA53502133 | ● FA53502033 |

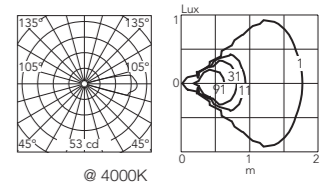

* Numero massimo di apparecchi per alimentatore / Maximum number of luminaires per power supply.

Numero massimo di apparecchi per alimentatore (Vin220÷240). Dati indicativi da verificare con le specifiche condizioni di installazione.	Maximum number of luminaires per power supply. (220÷240 V). These data must be checked taking into account the specific installation conditions.	Acc. RF25752	5
		Acc. RF25755	16
		Acc. RF25749	33

Gobi 180 Double

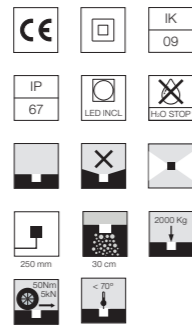
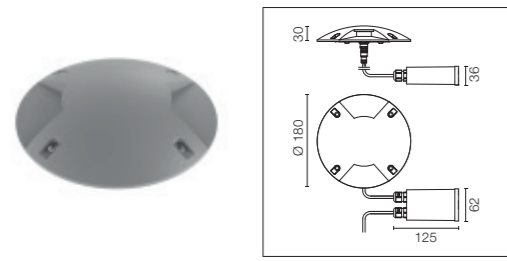

Sorgente a LED inclusa.
Alimentazione elettrica 220-240V ON/ OFF integrata.
Necessaria cassaforma da ordinare separatamente.
Alimentatore dotato di spezzone di cavo di 400mm con connettore a vite M12 a tenuta stagna verso l'apparecchio e spezzone di cavo di 300mm per collegamento alla linea elettrica.
Versione dimmerabile a richiesta.

LED light source included.
Integrated electric power supply 220-240V ON/OFF.
Requires a junction box to be ordered separately.
The luminaire is equipped with a protruding, neoprene, 400 mm cable with an M12 watertight screw-on connector towards the luminaire, and with a 300 mm cable for the connection to the power line.
Adjustable light intensity version available upon request.

Power Led: 7W - 2x233 lm ≠ OUTPUT 2x64 lm - 2700K/CRI 80 - 220±240V / 7W - 2x250 lm ≠ OUTPUT 2x69 lm - 3000K/CRI 80 - 220±240V / 7W - 2x266 lm ≠ OUTPUT 2x74 lm - 4000K/CRI 80 - 220±240V

2700K

- FA53504901
- FA53504906
- FA53504912
- FA53504918
- FA53504930
- FA53504933

3000K

- FA53501501
- FA53501506
- FA53501512
- FA53501518
- FA53501530
- FA53501533

4000K

- FA53501401
- FA53501406
- FA53501412
- FA53501418
- FA53501430
- FA53501433

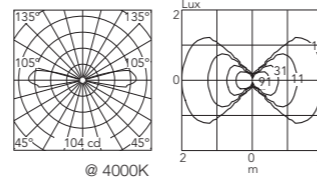

Gobi 180 Double Low Voltage

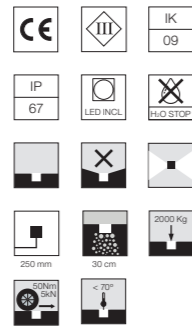
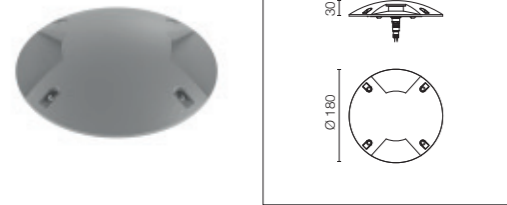

Sorgente a LED inclusa.
Alimentazione elettrica 220-240V ON/ OFF integrata.
Necessaria cassaforma da ordinare separatamente.
Alimentatore dotato di spezzone di cavo di 400mm con connettore a vite M12 a tenuta stagna verso l'apparecchio e spezzone di cavo di 300mm per collegamento alla linea elettrica.
Versione dimmerabile a richiesta.

LED light source included.
Integrated electric power supply 220-240V ON/OFF.
Requires a junction box to be ordered separately.
The luminaire is equipped with a protruding, neoprene, 400 mm cable with an M12 watertight screw-on connector towards the luminaire, and with a 300 mm cable for the connection to the power line.
Adjustable light intensity version available upon request.

Power Led: 6,4W - 2x233 lm ≠ OUTPUT 2x64 lm - 2700K/CRI 80 - 24dc / 6,4W - 2x250 lm ≠ OUTPUT 2x69 lm - 3000K/CRI 80 - 24dc / 6,4W - 2x266 lm ≠ OUTPUT 2x74 lm - 4000K/CRI 80 - 24dc

2700K

- FA53505001
- FA53505006
- FA53505012
- FA53505018
- FA53505030
- FA53505033

3000K

- FA53503301
- FA53503306
- FA53503312
- FA53503318
- FA53503330
- FA53503333

4000K

- FA53503201
- FA53503206
- FA53503212
- FA53503218
- FA53503230
- FA53503233

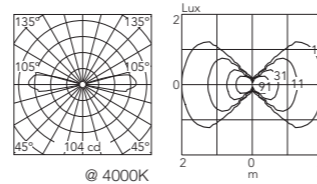

* Numero massimo di apparecchi per alimentatore / Maximum number of luminaires per power supply.

Numero massimo di apparecchi per alimentatore (Vin220±240). Dati indicativi da verificare con le specifiche condizioni di installazione.	Maximum number of luminaires per power supply. (220±240 V). These data must be checked taking into account the specific installation conditions.	Acc. RF25752	2
		Acc. RF25755	5
		Acc. RF25749	8

Gobi 130 Double

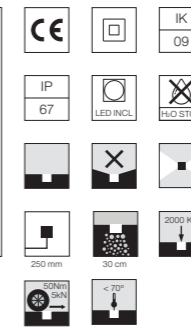
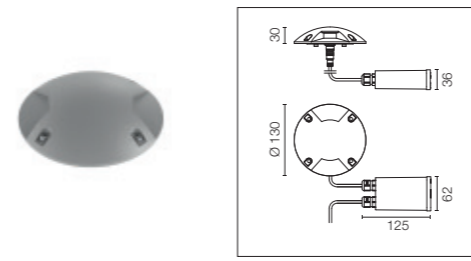

Sorgente a LED inclusa.
Alimentazione elettrica 220-240V ON/ OFF integrata.
Necessaria cassaforma da ordinare separatamente.
Alimentatore dotato di spezzone di cavo di 400mm con connettore a vite M12 a tenuta stagna verso l'apparecchio e spezzone di cavo di 300mm per collegamento alla linea elettrica.
Versione dimmerabile a richiesta.

LED light source included.
Integrated electric power supply 220-240V ON/OFF.
Requires a junction box to be ordered separately.
The luminaire is equipped with a protruding, neoprene, 400 mm cable with an M12 watertight screw-on connector towards the luminaire, and with a 300 mm cable for the connection to the power line.
Adjustable light intensity version available upon request.

Power Led: 5W - 2x129 lm ≠ OUTPUT 2x35 lm - 2700K/CRI 80 - 220±240V / 5W - 2x139 lm ≠ OUTPUT 2x38 lm - 3000K/CRI 80 - 220±240V / 5W - 2x148 lm ≠ OUTPUT 2x41 lm - 4000K/CRI 80 - 220±240V

2700K

- FA53504301
- FA53504306
- FA53504312
- FA53504318
- FA53504330
- FA53504333

3000K

- FA53500601
- FA53500606
- FA53500612
- FA53500618
- FA53500630
- FA53500633

4000K

- FA53500501
- FA53500506
- FA53500512
- FA53500518
- FA53500530
- FA53500533

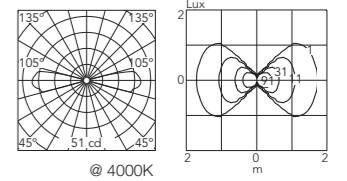

Gobi 130 Double Low Voltage

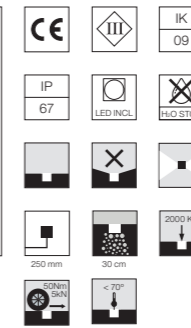
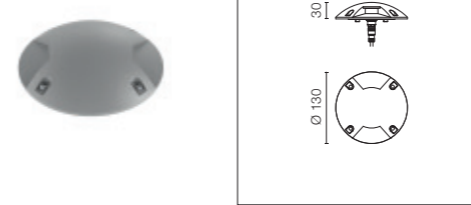

Sorgente a LED inclusa.
Alimentazione elettrica 220-240V ON/ OFF integrata.
Necessaria cassaforma da ordinare separatamente.
Alimentatore dotato di spezzone di cavo di 400mm con connettore a vite M12 a tenuta stagna verso l'apparecchio e spezzone di cavo di 300mm per collegamento alla linea elettrica.
Versione dimmerabile a richiesta.

LED light source included.
Integrated electric power supply 220-240V ON/OFF.
Requires a junction box to be ordered separately.
The luminaire is equipped with a protruding, neoprene, 400 mm cable with an M12 watertight screw-on connector towards the luminaire, and with a 300 mm cable for the connection to the power line.
Adjustable light intensity version available upon request.

Power Led: 3,5W - 2x129 lm ≠ OUTPUT 2x35 lm - 2700K/CRI 80 - 24dc / 3,5W - 2x139 lm ≠ OUTPUT 2x38 lm - 3000K/CRI 80 - 24dc / 3,5W - 2x148 lm ≠ OUTPUT 2x41 lm - 4000K/CRI 80 - 24dc

2700K

- FA53504401
- FA53504406
- FA53504412
- FA53504418
- FA53504430
- FA53504433

3000K

- FA53502401
- FA53502406
- FA53502412
- FA53502418
- FA53502430
- FA53502433

4000K

- FA53502301
- FA53502306
- FA53502312
- FA53502318
- FA53502330
- FA53502333

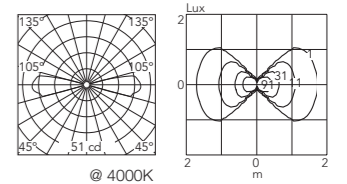

* Numero massimo di apparecchi per alimentatore / Maximum number of luminaires per power supply.

Numero massimo di apparecchi per alimentatore (Vin220±240). Dati indicativi da verificare con le specifiche condizioni di installazione.	Maximum number of luminaires per power supply. (220±240 V). These data must be checked taking into account the specific installation conditions.	Acc. RF25752	2
		Acc. RF25755	10
		Acc. RF25749	19

Gobi 180 Multi

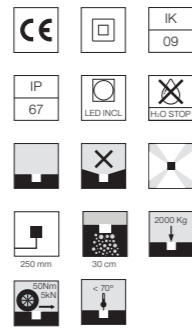
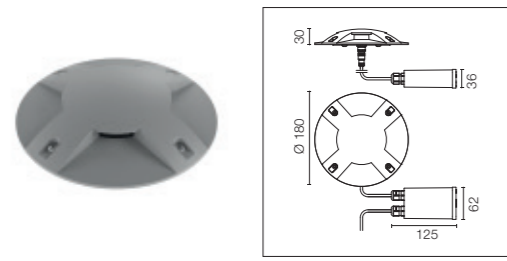

Sorgente a LED inclusa.
Alimentazione elettrica 220-240V ON/ OFF integrata.
Necessaria cassaforma da ordinare separatamente.
Alimentatore dotato di spezzone di cavo di 400mm con connettore a vite M12 a tenuta stagna verso l'apparecchio e spezzone di cavo di 300mm per collegamento alla linea elettrica.
Versione dimmerabile a richiesta.

LED light source included.
Integrated electric power supply 220-240V ON/OFF.
Requires a junction box to be ordered separately.
The luminaire is equipped with a protruding, neoprene, 400 mm cable with an M12 watertight screw-on connector towards the luminaire, and with a 300 mm cable for the connection to the power line.
Adjustable light intensity version available upon request.

Power Led: 12W - 4x233 lm \neq OUTPUT 4x64 lm - 2700K/CRI 80 - 220÷240V / 12W - 4x250 lm \neq OUTPUT 4x69 lm - 3000K/CRI 80 - 220÷240V / 12W - 4x266 lm \neq OUTPUT 4x74 lm - 4000K/CRI 80 - 220÷240V

2700K

- FA53505101
- FA53505106
- FA53505112
- FA53505118
- FA53505130
- FA53505133

3000K

- FA53501801
- FA53501806
- FA53501812
- FA53501818
- FA53501830
- FA53501833

4000K

- FA53501701
- FA53501706
- FA53501712
- FA53501718
- FA53501730
- FA53501733

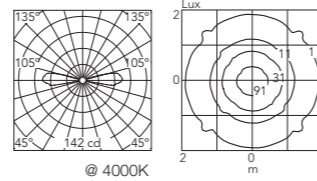

Gobi 180 Multi Low Voltage

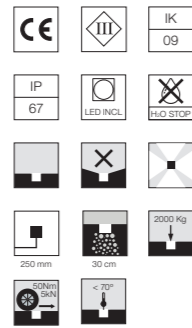
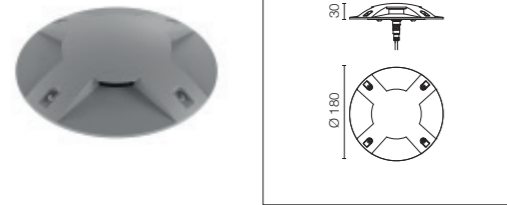

Sorgente a LED inclusa.
Alimentazione elettrica 220-240V ON/ OFF integrata.
Necessaria cassaforma da ordinare separatamente.
Alimentatore dotato di spezzone di cavo di 400mm con connettore a vite M12 a tenuta stagna verso l'apparecchio e spezzone di cavo di 300mm per collegamento alla linea elettrica.
Versione dimmerabile a richiesta.

LED light source included.
Integrated electric power supply 220-240V ON/OFF.
Requires a junction box to be ordered separately.
The luminaire is equipped with a protruding, neoprene, 400 mm cable with an M12 watertight screw-on connector towards the luminaire, and with a 300 mm cable for the connection to the power line.
Adjustable light intensity version available upon request.

Power Led: 11,2W - 4x233 lm \neq OUTPUT 4x64 lm - 2700K/CRI 80 - 24dc / 11,2W - 4x250 lm \neq OUTPUT 4x69 lm - 3000K/CRI 80 - 24dc / 11,2W - 4x266 lm \neq OUTPUT 4x74 lm - 4000K/CRI 80 - 24dc

2700K

- FA53505201
- FA53505206
- FA53505212
- FA53505218
- FA53505230
- FA53505233

3000K

- FA53503601
- FA53503606
- FA53503612
- FA53503618
- FA53503630
- FA53503633

4000K

- FA53503501
- FA53503506
- FA53503512
- FA53503518
- FA53503530
- FA53503533

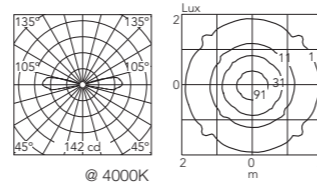

* Numero massimo di apparecchi per alimentatore / Maximum number of luminaires per power supply.

Numero massimo di apparecchi per alimentatore (Vin220÷240). Dati indicativi da verificare con le specifiche condizioni di installazione.	Maximum number of luminaires per power supply. (220÷240 V). These data must be checked taking into account the specific installation conditions.	Acc. RF25752	1
		Acc. RF25755	3
		Acc. RF25749	6

Gobi 130 Multi

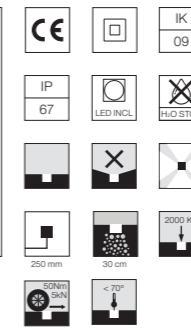
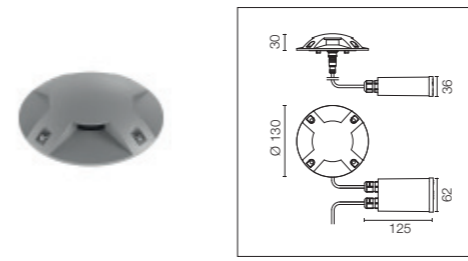

Sorgente a LED inclusa.
Alimentazione elettrica 220-240V ON/ OFF integrata.
Necessaria cassaforma da ordinare separatamente.
Alimentatore dotato di spezzone di cavo di 400mm con connettore a vite M12 a tenuta stagna verso l'apparecchio e spezzone di cavo di 300mm per collegamento alla linea elettrica.
Versione dimmerabile a richiesta.

LED light source included.
Integrated electric power supply 220-240V ON/OFF.
Requires a junction box to be ordered separately.
The luminaire is equipped with a protruding, neoprene, 400 mm cable with an M12 watertight screw-on connector towards the luminaire, and with a 300 mm cable for the connection to the power line.
Adjustable light intensity version available upon request.

Power Led: 7W - 4x129 lm \neq OUTPUT 4x35 lm - 2700K/CRI 80 - 220÷240V / 7W - 4x139 lm \neq OUTPUT 4x38 lm - 3000K/CRI 80 - 220÷240V / 7W - 4x148 lm \neq OUTPUT 4x41 lm - 4000K/CRI 80 - 220÷240V

2700K

- FA53504501
- FA53504506
- FA53504512
- FA53504518
- FA53504530
- FA53504533

3000K

- FA53500901
- FA53500906
- FA53500912
- FA53500918
- FA53500930
- FA53500933

4000K

- FA53500801
- FA53500806
- FA53500812
- FA53500818
- FA53500830
- FA53500833

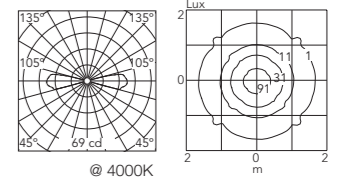

Gobi 130 Multi Low Voltage

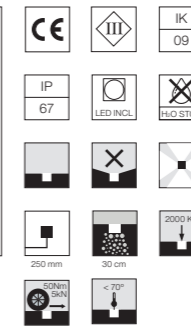
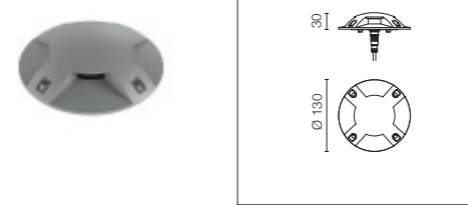

Sorgente a LED inclusa.
Alimentazione elettrica 220-240V ON/ OFF integrata.
Necessaria cassaforma da ordinare separatamente.
Alimentatore dotato di spezzone di cavo di 400mm con connettore a vite M12 a tenuta stagna verso l'apparecchio e spezzone di cavo di 300mm per collegamento alla linea elettrica.
Versione dimmerabile a richiesta.

LED light source included.
Integrated electric power supply 220-240V ON/OFF.
Requires a junction box to be ordered separately.
The luminaire is equipped with a protruding, neoprene, 400 mm cable with an M12 watertight screw-on connector towards the luminaire, and with a 300 mm cable for the connection to the power line.
Adjustable light intensity version available upon request.

Power Led: 5,8W - 4x129 lm \neq OUTPUT 4x35 lm - 2700K/CRI 80 - 24dc / 5,8W - 4x139 lm \neq OUTPUT 4x38 lm - 3000K/CRI 80 - 24dc / 5,8W - 4x148 lm \neq OUTPUT 4x41 lm - 4000K/CRI 80 - 24dc

2700K

- FA53504601
- FA53504606
- FA53504612
- FA53504618
- FA53504630
- FA53504633

3000K

- FA53502701
- FA53502706
- FA53502712
- FA53502718
- FA53502730
- FA53502733

4000K

- FA53502601
- FA53502606
- FA53502612
- FA53502618
- FA53502630
- FA53502633

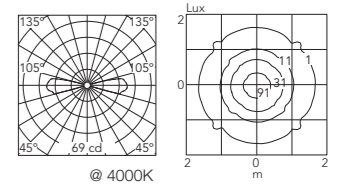

* Numero massimo di apparecchi per alimentatore / Maximum number of luminaires per power supply.

Numero massimo di apparecchi per alimentatore (Vin220÷240). Dati indicativi da verificare con le specifiche condizioni di installazione.	Maximum number of luminaires per power supply. (220÷240 V). These data must be checked taking into account the specific installation conditions.	Acc. RF25752	1
		Acc. RF25755	7
		Acc. RF25749	12

Gobi: Accessori / Accessories

Scatola per incasso.	Box for installation.	Gobi 180 FA194		
Base di fissaggio a terra ad alta resistenza	High resistance in-ground box for installation	Gobi 180 FA195		
Scatola per incasso.	Box for installation.	Gobi 130 FA192		
Base di fissaggio a terra ad alta resistenza	High resistance in-ground box for installation	Gobi 130 FA193		

Gobi 130/180 220÷240V version - Wiring Installation

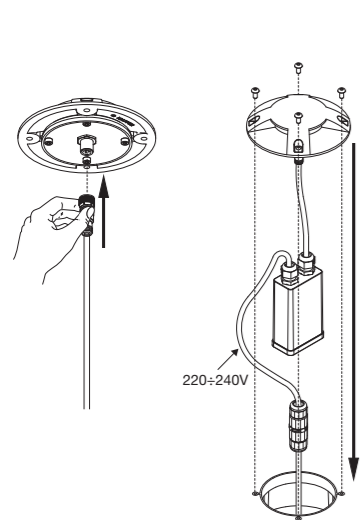

Example of installation

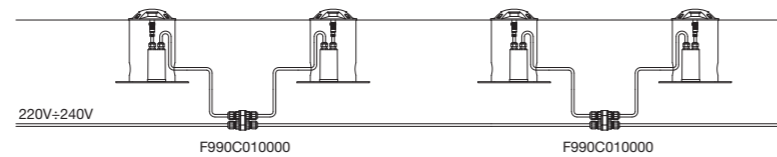

Gobi 130/180 24Vdc version - Wiring Installation

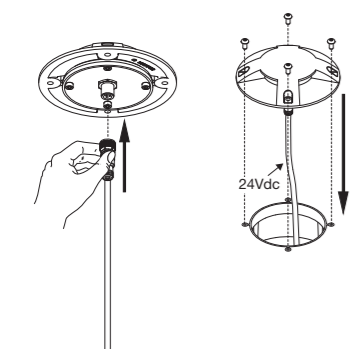

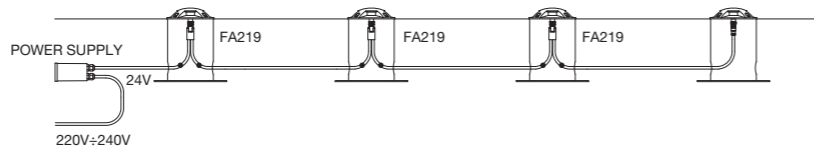

Example of installation 1



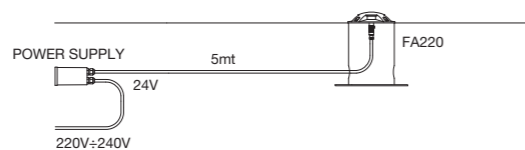





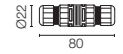
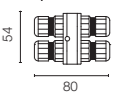
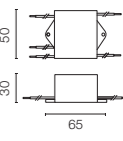

Example of installation 2

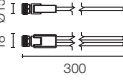

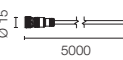
Gobi: Driver/ Drivers

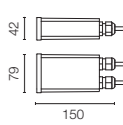
Sistema di giunzione IP68 a 2 vie 2 poli. (Ø4÷6,9mm cavo).	2 way terminal block 2 poles IP68. (Ø4÷6,9mm cable).	F990C050000		
Non può essere alloggiato nella scatola per incasso.	It can't be placed in the recessed box for installation.			
Sistema di giunzione IP68 H2O Stop anti-condensa a 2 vie 4 poli.	2 way terminal block 4 poles IP68 H2O Stop.	F990C00A000		
Sistema di giunzione IP68 H2O Stop anti-condensa a 3/4 vie 4 poli. (Ø5,5÷12mm cavo).	3/4 way terminal block 4 poles IP68 H2O Stop. (Ø5,5÷12mm cable).	F990C010000		
Dispositivo di protezione per il sovraccarico. 240 Vac. Corrente massima di scarica 10KA (8/29us). Massima corrente operativa 5A. Adatto per la connessione in serie. IP66.	Surge protection device. 275Vac. Maximum discharge current 10KA (8/20us). Maximum operating current 5A. Suitable for series connection. IP66.	F990E00A000		

Gobi Low Voltage: Driver/ Drivers

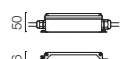
Connettore splitter m12.	Splitter m12 connector.	FA219		
Connettore singolo m12 L.5.000mm.	M12 single connector L.5.000mm.	FA220		
Alimentatore per installazione remota 24Vdc 20W / 220-240V IP67 Classe II selv.	Power supply for remote installation 24Vdc 20W / 220-240V IP67 Class II selv.	*RF25752		
Alimentatore per installazione remota 24Vdc 50W / 120-240V IP67 Classe II selv.	Power supply for remote installation 24Vdc 50W / 120-240V IP67 Class II selv.	*RF25755		
Alimentatore per installazione remota 24Vdc 70W / 220-240V IP67 Classe II selv.	Power supply for remote installation 24Vdc 70W / 220-240V IP67 Class II selv.	*RF25749		

Gobi 65 Mono

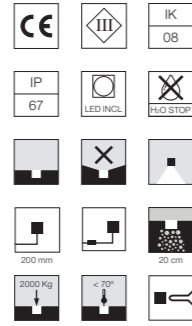
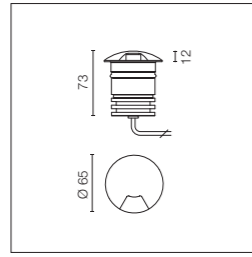

Sorgente a LED inclusa. Alimentazione elettrica remota 24V dc da ordinare separatamente. Necessaria cassaforma da ordinare separatamente. Dotato di spezzone di cavo uscente in neoprene 200 mm con sistema integrato di giunzione H2O STOP e kit con connettori crimp e guaina termorestringente adesiva per connessione a tenuta stagna. Versione dimmerabile a richiesta.

LED source included. 24V dc remote electric power supply to be ordered separately. Requires a junction box to be ordered separately. The luminaire is equipped with a protruding, 200 mm cable with an integrated H2O STOP connection system and a wiring kit with crimp connectors and adhesive heat-shrink tubing guaranteeing the water tightness of the connection. Adjustable light intensity version available upon request.

Power Led: 3,4W - 169 lm ≠ OUTPUT 15 lm - 2700K/CRI 80 - 24Vdc / 3,4W - 182 lm ≠ OUTPUT 16 lm - 3000K/CRI 80 - 24Vdc / 3,4W - 198 lm ≠ OUTPUT 18 lm - 4000K/CRI 80 - 24Vdc

2700K

- FA51824201
- FA51824206
- FA51824212
- FA51824218
- FA51824230
- FA51824233
- FA51824256

3000K

- FA51804301
- FA51804306
- FA51804312
- FA51804318
- FA51804330
- FA51804333
- FA51804356

4000K

- FA51804201
- FA51804206
- FA51804212
- FA51804218
- FA51804230
- FA51804233
- FA51804256

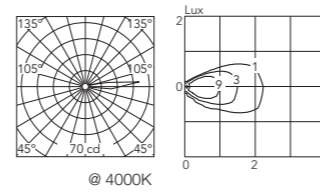

Gobi 65 Triple

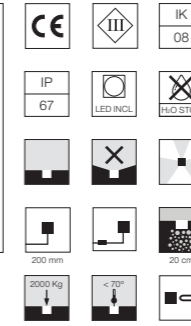
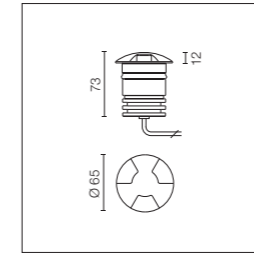

Sorgente a LED inclusa. Alimentazione elettrica remota 24V dc da ordinare separatamente. Necessaria cassaforma da ordinare separatamente. Dotato di spezzone di cavo uscente in neoprene 200 mm con sistema integrato di giunzione H2O STOP e kit con connettori crimp e guaina termorestringente adesiva per connessione a tenuta stagna. Versione dimmerabile a richiesta.

LED source included. 24V dc remote electric power supply to be ordered separately. Requires a junction box to be ordered separately. The luminaire is equipped with a protruding, 200 mm cable with an integrated H2O STOP connection system and a wiring kit with crimp connectors and adhesive heat-shrink tubing guaranteeing the water tightness of the connection. Adjustable light intensity version available upon request.

Power Led: 3,4W - 3x169 lm ≠ OUTPUT 3x15 lm - 2700K/CRI 80 - 24Vdc / 3,4W - 3x182 lm ≠ OUTPUT 3x16 lm - 3000K/CRI 80 - 24Vdc / 3,4W - 3x198 lm ≠ OUTPUT 3x18 lm - 4000K/CRI 80 - 24Vdc

2700K

- FA51826201
- FA51826206
- FA51826212
- FA51826218
- FA51826230
- FA51826233
- FA51826256

3000K

- FA51806301
- FA51806306
- FA51806312
- FA51806318
- FA51806330
- FA51806333
- FA51806356

4000K

- FA51806201
- FA51806206
- FA51806212
- FA51806218
- FA51806230
- FA51806233
- FA51806256

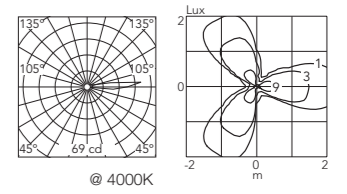

Gobi 65 Double

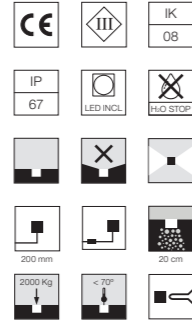
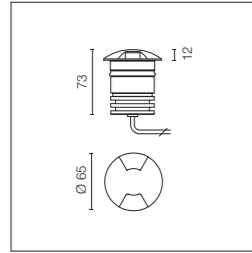

Sorgente a LED inclusa. Alimentazione elettrica remota 24V dc da ordinare separatamente. Necessaria cassaforma da ordinare separatamente. Dotato di spezzone di cavo uscente in neoprene 200 mm con sistema integrato di giunzione H2O STOP e kit con connettori crimp e guaina termorestringente adesiva per connessione a tenuta stagna. Versione dimmerabile a richiesta.

LED source included. 24V dc remote electric power supply to be ordered separately. Requires a junction box to be ordered separately. The luminaire is equipped with a protruding, 200 mm cable with an integrated H2O STOP connection system and a wiring kit with crimp connectors and adhesive heat-shrink tubing guaranteeing the water tightness of the connection. Adjustable light intensity version available upon request.

Power Led: 3,4W - 2x169 lm ≠ OUTPUT 2x15 lm - 2700K/CRI 80 - 24Vdc / 3,4W - 2x182 lm ≠ OUTPUT 2x16 lm - 3000K/CRI 80 - 24Vdc / 3,4W - 2x98 lm ≠ OUTPUT 2x18 lm - 4000K/CRI 80 - 24Vdc

2700K

- FA51825201
- FA51825206
- FA51825212
- FA51825218
- FA51825230
- FA51825233
- FA51825256

3000K

- FA51805301
- FA51805306
- FA51805312
- FA51805318
- FA51805330
- FA51805333
- FA51805356

4000K

- FA51805201
- FA51805206
- FA51805212
- FA51805218
- FA51805230
- FA51805233
- FA51805256

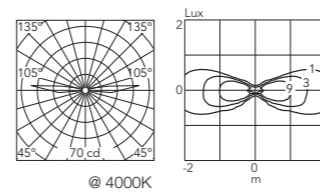

Gobi 65 Multi

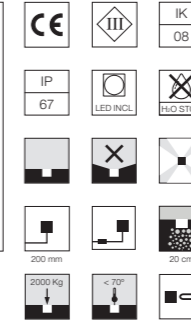
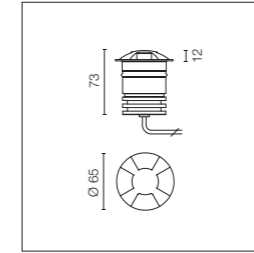

Sorgente a LED inclusa. Alimentazione elettrica remota 24V dc da ordinare separatamente. Necessaria cassaforma da ordinare separatamente. Dotato di spezzone di cavo uscente in neoprene 200 mm con sistema integrato di giunzione H2O STOP e kit con connettori crimp e guaina termorestringente adesiva per connessione a tenuta stagna. Versione dimmerabile a richiesta.

LED source included. 24V dc remote electric power supply to be ordered separately. Requires a junction box to be ordered separately. The luminaire is equipped with a protruding, 200 mm cable with an integrated H2O STOP connection system and a wiring kit with crimp connectors and adhesive heat-shrink tubing guaranteeing the water tightness of the connection. Adjustable light intensity version available upon request.

Power Led: 3,4W - 4x169 lm ≠ OUTPUT 4x15 lm - 2700K/CRI 80 - 24Vdc / 3,4W - 4x182 lm ≠ OUTPUT 4x16 lm - 3000K/CRI 80 - 24Vdc / 3,4W - 4x198 lm ≠ OUTPUT 4x18 lm - 4000K/CRI 80 - 24Vdc

2700K

- FA51827201
- FA51827206
- FA51827212
- FA51827218
- FA51827230
- FA51827233
- FA51827256

3000K

- FA51807301
- FA51807306
- FA51807312
- FA51807318
- FA51807330
- FA51807333
- FA51807356

4000K

- FA51807201
- FA51807206
- FA51807212
- FA51807218
- FA51807230
- FA51807233
- FA51807256

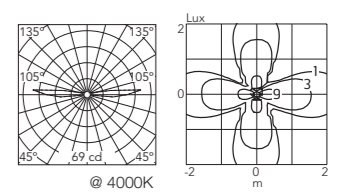

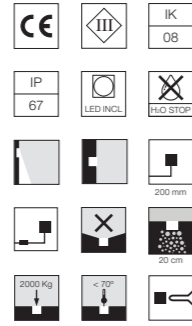
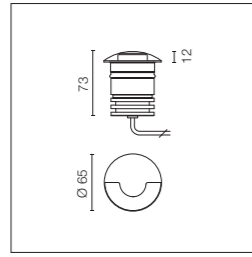

Sorgente a LED inclusa. Alimentazione elettrica remota 24V dc da ordinare separatamente. Necessaria cassaforma da ordinare separatamente. Dotato di spezzone di cavo uscente in neoprene 200 mm e kit con connettori crimp e guaina termorestringente adesiva per connessione a tenuta stagna. Versione dimmerabile a richiesta.

LED source included. 24V dc remote electric power supply to be ordered separately. Requires a junction box to be ordered separately. The luminaire is equipped with a protruding, 200 mm cable and a wiring kit with crimp connectors and adhesive heat-shrink tubing guaranteeing the water tightness of the connection. Adjustable light intensity version available upon request.

Power Led: 3,4W - 169 lm ≠ OUTPUT 47 lm - 2700K/CRI 80 - 24Vdc / 3,4W - 182 lm ≠ OUTPUT 50 lm - 3000K/CRI 80 - 24Vdc / 3,4W - 198 lm ≠ OUTPUT 54 lm - 4000K/CRI 80 - 24Vdc

- | | | |
|--|--|--|
| <p>2700K</p> <ul style="list-style-type: none"> ○ FA51828201 ● FA51828206 ● FA51828212 ● FA51828218 ● FA51828230 ● FA51828233 ● FA51828256 | <p>3000K</p> <ul style="list-style-type: none"> ○ FA51808301 ● FA51808306 ● FA51808312 ● FA51808318 ● FA51808330 ● FA51808333 ● FA51808356 | <p>4000K</p> <ul style="list-style-type: none"> ○ FA51808201 ● FA51808206 ● FA51808212 ● FA51808218 ● FA51808230 ● FA51808233 ● FA51808256 |
|--|--|--|

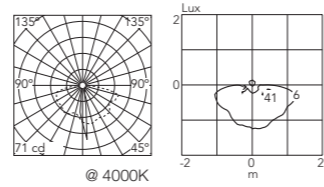

Scatola per incasso	Box for installation	F004Z0K0000		
Sistema di giunzione IP68 a 2 vie 2 poli. (Ø4÷6,9mm cavo).	2 way terminal block 2 poles IP68. (Ø4÷6,9mm cable).	F990C050000		
Non può essere alloggiato nella scatola per incasso.	It can't be placed in the recessed box for installation.			

Gobi 65: Driver/ Drivers

Alimentatore doppia funzione Vout 24Vdc: 8W/100÷240V Iout 350ma: 6x1W/100÷240V IP20 Classe II Selv Eq.	Power supply dual function Vout 24Vdc: 8W/100÷240V Iout 350ma: 6x1W/100÷240V IP20 Class II Selv Eq.	*RF25754		
Alimentatore 24V 8W / 110-240V IP65 Classe II selv.	Power supply 24V 8W / 110-240V IP65 Class II selv.	*RF25748		
Alimentatore 24V 10W / 110-240V IP20 Classe II selv.	Power supply 24V 10W / 110-240V IP20 Class II selv.	*RF25747		
Alimentatore 24V 10W / 110-240V IP67 Classe II selv.	Power supply 24V 10W / 110-240V IP67 Class II selv.	*RF25757		
Alimentatore per installazione remota 24Vdc 20W / 220-240V IP67 Classe II selv.	Power supply for remote installation 24Vdc 20W / 220-240V IP67 Class II selv.	*RF25752		
Alimentatore per installazione remota 24Vdc 50W / 120-240V IP67 Classe II selv.	Power supply for remote installation 24Vdc 50W / 120-240V IP67 Class II selv.	*RF25755		
Alimentatore per installazione remota 24Vdc 70W / 220-240V IP67 Classe II selv.	Power supply for remote installation 24Vdc 70W / 220-240V IP67 Class II selv.	*RF25749		

* Numero massimo di apparecchi per alimentatore / Maximum number of luminaires per power supply.

Numero massimo di apparecchi per alimentatore (Vin220÷240). Dati indicativi da verificare con le specifiche condizioni di installazione.	Maximum number of luminaires per power supply. (220÷240 V). These data must be checked taking into account the specific installation conditions.	Acc. RF25754	1	Acc. RF25752	3
		Acc. RF25748	1	Acc. RF25755	9
		Acc. RF25747	2	Acc. RF25749	17
		Acc. RF25757	2		

Gobi 49 Mono

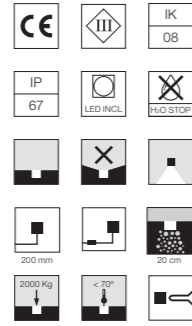
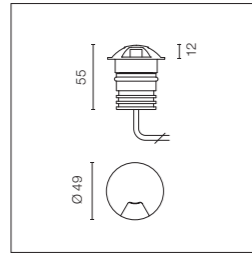

Sorgente a LED inclusa. Alimentazione elettrica remota 24V dc da ordinare separatamente. Necessaria cassaforma da ordinare separatamente. Dotato di spezzone di cavo uscente in neoprene 200 mm con sistema integrato di giunzione H2O STOP e kit con connettori crimp e guaina termorestringente adesiva per connessione a tenuta stagna. Versione dimmerabile a richiesta.

LED source included. 24V dc remote electric power supply to be ordered separately. Requires a junction box to be ordered separately. The luminaire is equipped with a protruding, 200 mm cable with an integrated H2O STOP connection system and a wiring kit with crimp connectors and adhesive heat-shrink tubing guaranteeing the water tightness of the connection. Adjustable light intensity version available upon request.

Power Led: 2,3W - 139 lm ≠ OUTPUT 10 lm - 2700K/CRI 80 -24Vdc / 2,3W - 149 lm ≠ OUTPUT 11 lm - 3000K/CRI 80 -24Vdc / 2,3W - 162 lm ≠ OUTPUT 12 lm - 4000K/CRI 80 -24Vdc

2700K

- FA51702501
- FA51702506
- FA51702512
- FA51702518
- FA51702530
- FA51702533
- FA51702556

3000K

- FA51702301
- FA51702306
- FA51702312
- FA51702318
- FA51702330
- FA51702333
- FA51702356

4000K

- FA51702201
- FA51702206
- FA51702212
- FA51702218
- FA51702230
- FA51702233
- FA51702256

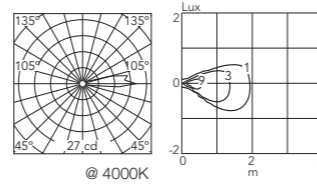

Gobi 49 Triple

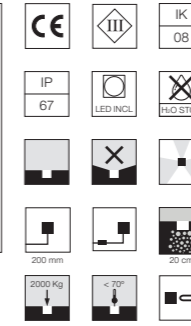
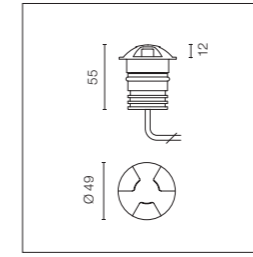

Sorgente a LED inclusa. Alimentazione elettrica remota 24V dc da ordinare separatamente. Necessaria cassaforma da ordinare separatamente. Dotato di spezzone di cavo uscente in neoprene 200 mm con sistema integrato di giunzione H2O STOP e kit con connettori crimp e guaina termorestringente adesiva per connessione a tenuta stagna. Versione dimmerabile a richiesta.

LED source included. 24V dc remote electric power supply to be ordered separately. Requires a junction box to be ordered separately. The luminaire is equipped with a protruding, 200 mm cable with an integrated H2O STOP connection system and a wiring kit with crimp connectors and adhesive heat-shrink tubing guaranteeing the water tightness of the connection. Adjustable light intensity version available upon request.

Power Led: 2,3W - 3x139 lm ≠ OUTPUT 3x10 lm - 2700K/CRI 80 -24Vdc / 2,3W - 3x149 lm ≠ OUTPUT 3x11 lm - 3000K/CRI 80 -24Vdc / 2,3W - 3x162 lm ≠ OUTPUT 3x12 lm - 4000K/CRI 80 -24Vdc

2700K

- FA51704501
- FA51704506
- FA51704512
- FA51704518
- FA51704530
- FA51704533
- FA51704556

3000K

- FA51704301
- FA51704306
- FA51704312
- FA51704318
- FA51704330
- FA51704333
- FA51704356

4000K

- FA51704201
- FA51704206
- FA51704212
- FA51704218
- FA51704230
- FA51704233
- FA51704256

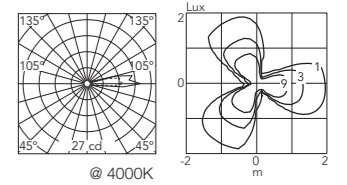

Gobi 49 Double

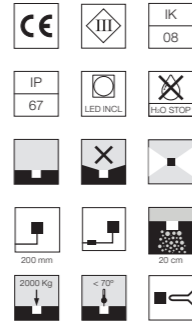
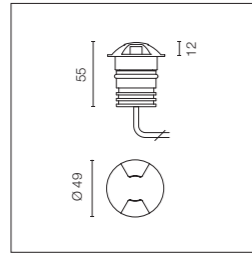

Sorgente a LED inclusa. Alimentazione elettrica remota 24V dc da ordinare separatamente. Necessaria cassaforma da ordinare separatamente. Dotato di spezzone di cavo uscente in neoprene 200 mm con sistema integrato di giunzione H2O STOP e kit con connettori crimp e guaina termorestringente adesiva per connessione a tenuta stagna. Versione dimmerabile a richiesta.

LED source included. 24V dc remote electric power supply to be ordered separately. Requires a junction box to be ordered separately. The luminaire is equipped with a protruding, 200 mm cable with an integrated H2O STOP connection system and a wiring kit with crimp connectors and adhesive heat-shrink tubing guaranteeing the water tightness of the connection. Adjustable light intensity version available upon request.

Power Led: 2,3W - 2x139 lm ≠ OUTPUT 2x10 lm - 2700K/CRI 80 -24Vdc / 2,3W - 2x149 lm ≠ OUTPUT 2x11 lm - 3000K/CRI 80 -24Vdc / 2,3W - 2x162 lm ≠ OUTPUT 2x12 lm - 4000K/CRI 80 -24Vdc

2700K

- FA51703501
- FA51703506
- FA51703512
- FA51703518
- FA51703530
- FA51703533
- FA51703556

3000K

- FA51703301
- FA51703306
- FA51703312
- FA51703318
- FA51703330
- FA51703333
- FA51703356

4000K

- FA51703201
- FA51703206
- FA51703212
- FA51703218
- FA51703230
- FA51703233
- FA51703256

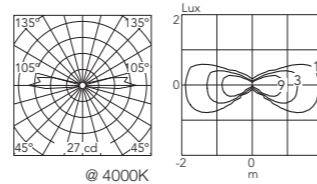

Gobi 49 Multi

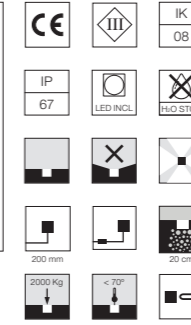
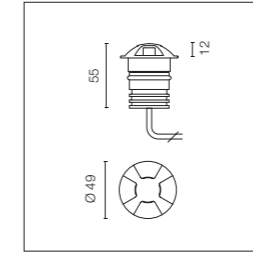

Sorgente a LED inclusa. Alimentazione elettrica remota 24V dc da ordinare separatamente. Necessaria cassaforma da ordinare separatamente. Dotato di spezzone di cavo uscente in neoprene 200 mm con sistema integrato di giunzione H2O STOP e kit con connettori crimp e guaina termorestringente adesiva per connessione a tenuta stagna. Versione dimmerabile a richiesta.

LED source included. 24V dc remote electric power supply to be ordered separately. Requires a junction box to be ordered separately. The luminaire is equipped with a protruding, 200 mm cable with an integrated H2O STOP connection system and a wiring kit with crimp connectors and adhesive heat-shrink tubing guaranteeing the water tightness of the connection. Adjustable light intensity version available upon request.

Power Led: 2,3W - 4x139 lm ≠ OUTPUT 4x10 lm - 2700K/CRI 80 -24Vdc / 2,3W - 4x149 lm ≠ OUTPUT 4x11 lm - 3000K/CRI 80 -24Vdc / 2,3W - 4x162 lm ≠ OUTPUT 4x12 lm - 4000K/CRI 80 -24Vdc

2700K

- FA51705501
- FA51705506
- FA51705512
- FA51705518
- FA51705530
- FA51705533
- FA51705556

3000K

- FA51705301
- FA51705306
- FA51705312
- FA51705318
- FA51705330
- FA51705333
- FA51705356

4000K

- FA51705201
- FA51705206
- FA51705212
- FA51705218
- FA51705230
- FA51705233
- FA51705256

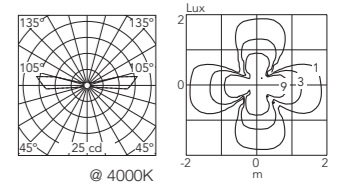

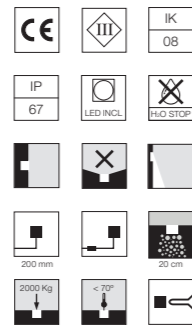
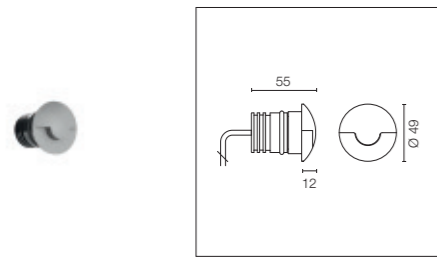

Sorgente a LED inclusa. Alimentazione elettrica remota 24V dc da ordinare separatamente. Necessaria cassaforma da ordinare separatamente. Dotato di spezzone di cavo uscente in neoprene 200 mm e kit con connettori crimp e guaina termorestringente adesiva per connessione a tenuta stagna. Versione dimmerabile a richiesta.

LED source included. 24V dc remote electric power supply to be ordered separately. Requires a junction box to be ordered separately. The luminaire is equipped with a protruding, 200 mm cable and a wiring kit with crimp connectors and adhesive heat-shrink tubing guaranteeing the water tightness of the connection. Adjustable light intensity version available upon request.

Power Led: 2,3W - 139 lm ≠ OUTPUT 36 lm - 2700K/CRI 80 -24Vdc / 2,3W - 149 lm ≠ OUTPUT 39 lm - 3000K/CRI 80 -24Vdc / 2,3W - 162 lm ≠ OUTPUT 42 lm - 4000K/CRI 80 -24Vdc

2700K

- FA51706501
- FA51706506
- FA51706512
- FA51706518
- FA51706530
- FA51706533
- FA51706556

3000K

- FA51706301
- FA51706306
- FA51706312
- FA51706318
- FA51706330
- FA51706333
- FA51706356

4000K

- FA51706201
- FA51706206
- FA51706212
- FA51706218
- FA51706230
- FA51706233
- FA51706256

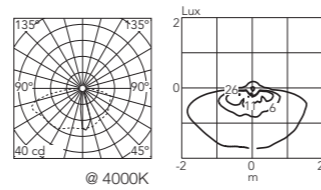

Gobi 49: Accessori / Accessories

Scatola per incasso	Box for installation	F004Z0J0000		
Sistema di giunzione IP68 a 2 vie 2 poli. (Ø4÷6,9mm cavo).	2 way terminal block 2 poles IP68. (Ø4÷6,9mm cable).	F990C050000		
Non può essere alloggiato nella scatola per incasso.	It can't be placed in the recessed box for installation.			

Gobi 49: Driver/ Drivers

Alimentatore doppia funzione Vout 24Vdc: 8W/100÷240V Iout 350ma: 6x1W/100÷240V IP20 Classe II Selv Eq.	Power supply dual function Vout 24Vdc: 8W/100÷240V Iout 350ma: 6x1W/100÷240V IP20 Class II Selv Eq.	*RF25754		
Alimentatore 24V 8W / 110-240V IP65 Classe II selv.	Power supply 24V 8W / 110-240V IP65 Class II selv.	*RF25748		
Alimentatore 24V 10W / 110-240V IP20 Classe II selv.	Power supply 24V 10W / 110-240V IP20 Class II selv.	*RF25747		
Alimentatore 24V 10W / 110-240V IP67 Classe II selv.	Power supply 24V 10W / 110-240V IP67 Class II selv.	*RF25757		
Alimentatore per installazione remota 24Vdc 20W / 220-240V IP67 Classe II selv.	Power supply for remote installation 24Vdc 20W / 220-240V IP67 Class II selv.	*RF25752		
Alimentatore per installazione remota 24Vdc 50W / 120-240V IP67 Classe II selv.	Power supply for remote installation 24Vdc 50W / 120-240V IP67 Class II selv.	*RF25755		
Alimentatore per installazione remota 24Vdc 70W / 220-240V IP67 Classe II selv.	Power supply for remote installation 24Vdc 70W / 220-240V IP67 Class II selv.	*RF25749		

* Numero massimo di apparecchi per alimentatore / Maximum number of luminaires per power supply.

Numero massimo di apparecchi per alimentatore (Vin220÷240). Dati indicativi da verificare con le specifiche condizioni di installazione.	Maximum number of luminaires per power supply. (220÷240 V). These data must be checked taking into account the specific installation conditions.	Acc. RF25754	1	Acc. RF25752	5
		Acc. RF25748	1	Acc. RF25755	14
		Acc. RF25747	4	Acc. RF25749	29
		Acc. RF25757	4		

C-Me



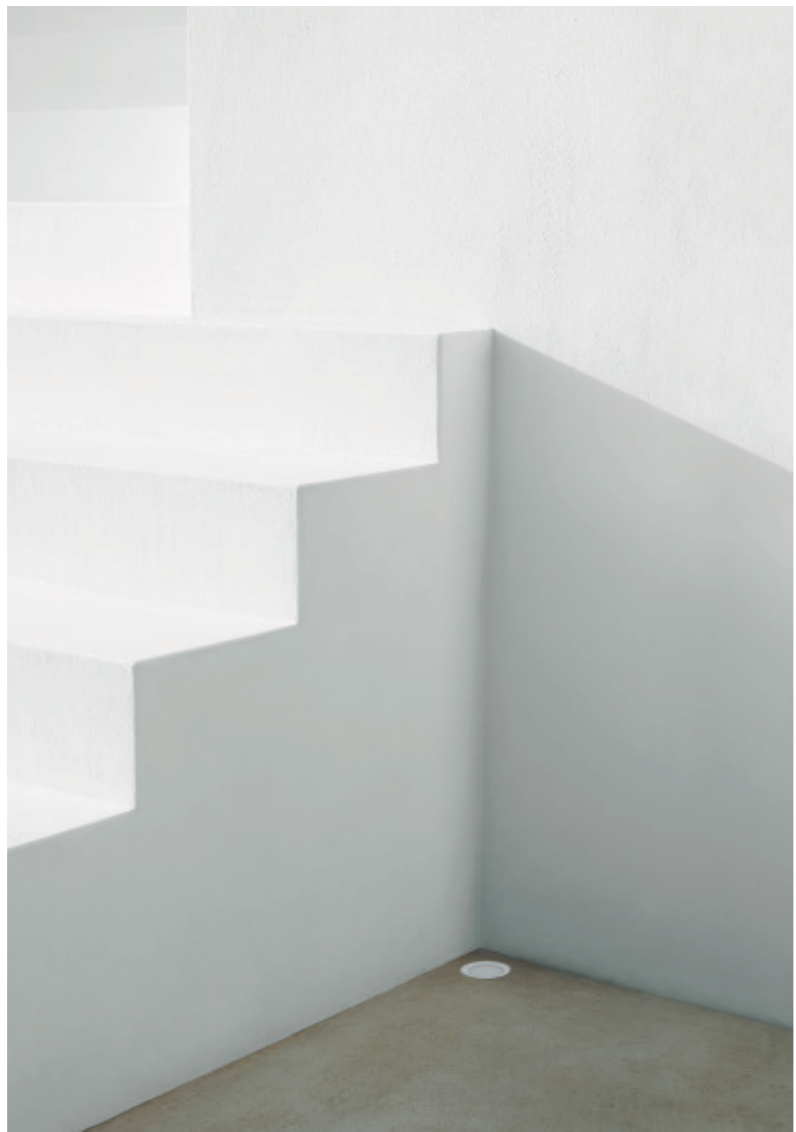

C-Me

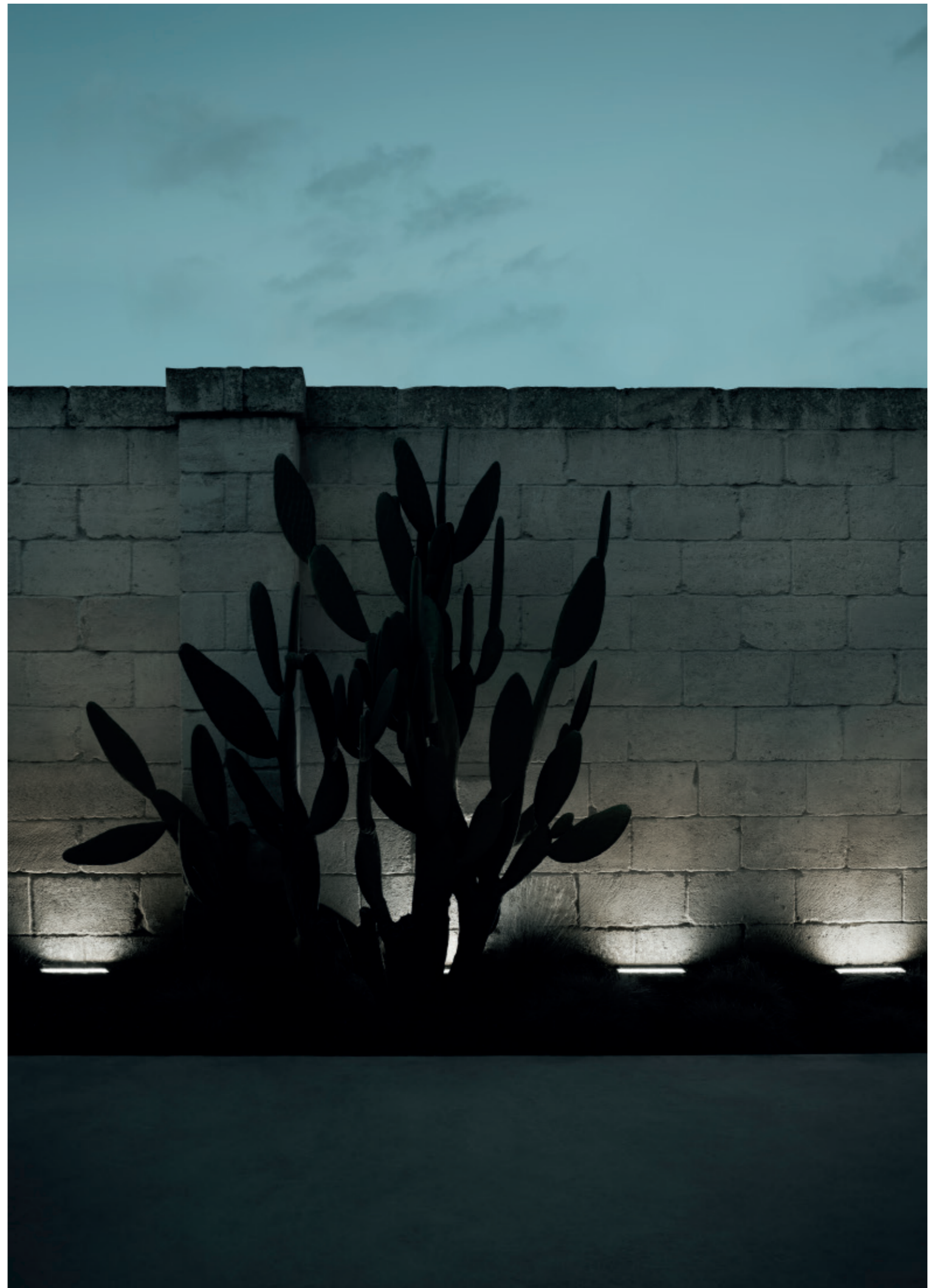

Famiglia / Family

C-Me Round 40



Power Led
up to 2,3W
up to 111 lm - 2700K/CRI 80
up to 121 lm - 3000K/CRI 80
up to 125 lm - 4000K/CRI 80
* Net lumen output

C-Me Round 70



Power Led
up to 5,9W
up to 359 lm - 2700K/CRI 80
up to 389 lm - 3000K/CRI 80
up to 404 lm - 4000K/CRI 80
* Net lumen output

RGB - Power Led
up to 3,4W
3CH x 350mA

C-Me Square 40



Power Led
up to 2,3W
up to 111 lm - 2700K/CRI 80
up to 121 lm - 3000K/CRI 80
up to 125 lm - 4000K/CRI 80
* Net lumen output

C-Me Square 70 / RGB



Power Led
up to 5,9W
up to 359 lm - 2700K/CRI 80
up to 389 lm - 3000K/CRI 80
up to 404 lm - 4000K/CRI 80
* Net lumen output

RGB - Power Led
up to 3,4W
3CH x 350mA

C-Me Opal Round 40



Power Led
up to 2,3W
up to 22 lm - 2700K/CRI 80
up to 23 lm - 3000K/CRI 80
up to 23 lm - 4000K/CRI 80
* Net lumen output

C-Me Opal Round 70 / RGB

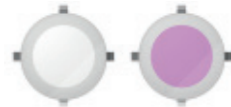

Power Led
up to 5,9W
up to 80 lm - 2700K/CRI 80
up to 82 lm - 3000K/CRI 80
up to 83 lm - 4000K/CRI 80
* Net lumen output

RGB - Power Led
up to 3,4W
3CH x 350mA

C-Me Opal Square 40



Power Led
up to 2,3W
up to 22 lm - 2700K/CRI 80
up to 23 lm - 3000K/CRI 80
up to 23 lm - 4000K/CRI 80
* Net lumen output

C-Me Opal Square 70 / RGB



Power Led
up to 5,9W
up to 80 lm - 2700K/CRI 80
up to 82 lm - 3000K/CRI 80
up to 83 lm - 4000K/CRI 80
* Net lumen output

RGB - Power Led
up to 3,4W
3CH x 350mA

C-Me Square 100



Power Led
up to 7,5W
up to 575 lm - 2700K/CRI 80
up to 616 lm - 3000K/CRI 80
up to 636 lm - 4000K/CRI 80
* Net lumen output

C-Me Rectangle



Power Led
up to 15W
up to 1150 lm - 2700K/CRI 80
up to 1232 lm - 3000K/CRI 80
up to 1711 lm - 4000K/CRI 80
* Net lumen output

C-Me Line



Power Led
up to 11,8W
up to 862 lm - 2700K/CRI 80
up to 924 lm - 3000K/CRI 80
up to 955 lm - 4000K/CRI 80
* Net lumen output

C-Me Opal Square 100 / RGB



Mid - Power Led
up to 6,8W
up to 396 lm - 2700K/CRI 80
up to 426 lm - 3000K/CRI 80
up to 447 lm - 4000K/CRI 80
* Net lumen output

RGB Low - Power Led
up to 6W
3CH x 24Vdc

C-Me Opal Rectangle / RGB



Mid - Power Led
up to 15,8W
up to 939 lm - 2700K/CRI 80
up to 426 lm - 3000K/CRI 80
up to 1010 lm - 4000K/CRI 80
* Net lumen output

RGB Low - Power Led
up to 10,5W
3CH x 24Vdc

C-Me Opal Line / RGB



Mid - Power Led
up to 10,5W
up to 538 lm - 2700K/CRI 80
up to 578 lm - 3000K/CRI 80
up to 607 lm - 4000K/CRI 80
* Net lumen output

RGB Low - Power Led
up to 8W
3CH x 24Vdc

Descrizione / Description

Famiglia di apparecchi di illuminazione ad incasso a terra calpestabili o a parete con sorgente luminosa a LED, caratterizzati dall'installazione a filo pavimento senza bordo di battuta ed assenza di viti a vista. Disponibili in versione quadrata e rotonda, in differenti tagli dimensionali e molteplici fasci di apertura. Disponibili versioni RGB per creazione di scenografie luminose colorate. L'installazione richiede una cassaforma da incasso da ordinare separatamente. È necessario garantire un livello adeguato di materiale drenante sotto la cassaforma o fornire un sistema di scarico per evitare il ristagno di acqua. Per garantire la tenuta del pressacavo è necessario utilizzare cavi elettrici flessibili idonei all'impiego in ambienti esterni.

C-Me

Apparecchi ad incasso a terra calpestabili o a parete, disponibili in due forme, tondo e quadrato, e due dimensioni per forma. Due fasci di apertura, spot e medium. Corpo dell'apparecchio in alluminio pressofuso lega EN AB 47100 (a basso contenuto di rame). Diffusore in vetro trasparente con bordo serigrafato nero, fissato attraverso un sistema di incollaggio robotizzato. Apparecchio in 24V dc, necessita di alimentatore remoto da ordinare separatamente.

C-Me Opal

Apparecchi ad incasso a terra calpestabili o a parete, disponibili in due forme, tondo e quadrato, e due dimensioni per forma. Fascio di apertura diffuso. Corpo dell'apparecchio in alluminio pressofuso lega EN AB 47100 (a basso contenuto di rame). Diffusore in vetro trasparente con bordo serigrafato bianco ed inserimento di inserto di materiale diffusivo al di sotto del vetro, fissato attraverso un sistema di incollaggio robotizzato. Apparecchio in 24V dc, necessita di alimentatore remoto da ordinare separatamente.

Family of ground recessed and walk-over, or wall recessed, luminaires with LED light source. The luminaires are characterized by an installation flush with the floor, with no visible screws. Available in square and round versions, of different dimensions and with different beam angles. Available in RGB version to create set designs using colored lights. The installation requires a recessed box to be ordered separately. To avoid water stagnation, it is necessary to insulate the lower part of the box with a layer of drainage material or other drainage system. In order to guarantee the preservation of the cable guide, it is recommended to use flexible electric cables specifically designed for outdoor use.

C-Me

Ground recessed and walk-over or wall recessed luminaire. Available in two formats (square and round) and two different dimensions for each format. Two beam angles: spot and medium. The structure and sink of the luminaire are made of EN AB-47100 die-cast aluminum (with low copper content). Transparent glass diffuser with black silkscreen border, fixed through a robotic gluing system.

C-Me Opal

Ground recessed and walk-over or wall recessed luminaire. Available in two versions (square and round) and two different dimensions for each version. Beam angle for a diffused light. The structure and sink of the luminaire are made of EN AB-47100 die-cast aluminum (with low copper content). Transparent glass diffuser with white silkscreen border. Material inserts for diffusion under the glass. The glass is fixed through a robotic gluing system. The 24V dc luminaire is powered by a remote power supply to be ordered separately.

C-Me Round 40

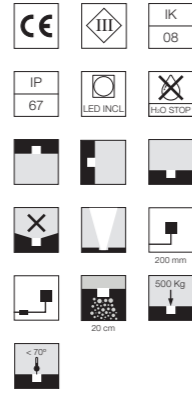
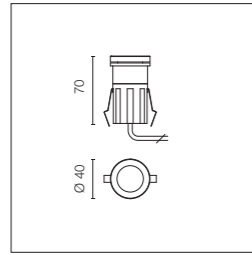

Sorgente a LED inclusa. Alimentazione elettrica remota 24V dc da ordinare separatamente. Necessaria cassaforma da ordinare separatamente. Dotato di spezzone di cavo uscente in neoprene 200 mm e kit con connettori crimp e guaina termorestringente adesiva per connessione a tenuta stagna. Vetro trasparente extrachiaro. Versione dimmerabile a richiesta.

LED source included. 24V dc remote electric power supply to be ordered separately. Requires a junction box to be ordered separately. The luminaire is equipped with a protruding, neoprene, 200 mm cable and a wiring kit with crimp connectors and adhesive heat-shrink tubing guaranteeing the water tightness of the connection. Extra clear transparent glass. Adjustable light intensity version available upon request.

Optic Spot 10°

Power Led: 2,3W - 144 lm ≠ OUTPUT 111 lm - 2700K/CRI 80 -24Vdc / 2,3W - 155 lm ≠ OUTPUT 121 lm - 3000K/CRI 80 -24Vdc / 2,3W - 161 lm ≠ OUTPUT 125 lm - 4000K/CRI 80 -24Vdc

2700K	3000K	4000K
FA10018112	FA10017612	FA10017712

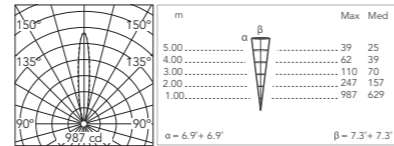

@ 3000K

Optic Medium 45°

Power Led: 2,3W - 144 lm ≠ OUTPUT 102 lm - 2700K/CRI 80 -24Vdc / 2,3W - 155 lm ≠ OUTPUT 110 lm - 3000K/CRI 80 -24Vdc / 2,3W - 161 lm ≠ OUTPUT 114 lm - 4000K/CRI 80 -24Vdc

2700K	3000K	4000K
FA10018140	FA10017640	FA10017740

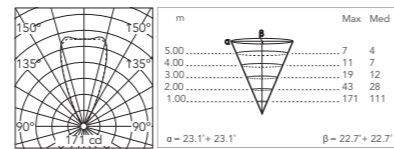

@ 3000K

C-Me Opal Round 40

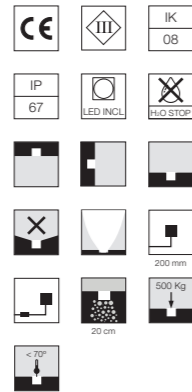
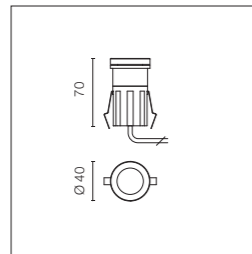

Sorgente a LED inclusa. Alimentazione elettrica remota 24V dc da ordinare separatamente. Necessaria cassaforma da ordinare separatamente. Dotato di spezzone di cavo uscente in neoprene 200 mm e kit con connettori crimp e guaina termorestringente adesiva per connessione a tenuta stagna. Vetro con diffusore opale. Dimmerabile.

LED source included. 24V dc remote electric power supply to be ordered separately. Requires a junction box to be ordered separately. The luminaire is equipped with a protruding, neoprene, 200 mm cable and a wiring kit with crimp connectors and adhesive heat-shrink tubing guaranteeing the water tightness of the connection. Glass with opal diffuser. Adjustable light intensity.

Diffused Light

Mid-Power Led: 2,3W - 42 lm ≠ OUTPUT 22 lm - 2700K/CRI 80 -24Vdc / 2,3W - 44 lm ≠ OUTPUT 23 lm - 3000K/CRI 80 -24Vdc / 2,3W - 45 lm ≠ OUTPUT 23 lm - 4000K/CRI 80 -24Vdc

2700K	3000K	4000K
FA100181118	FA100176118	FA100177118

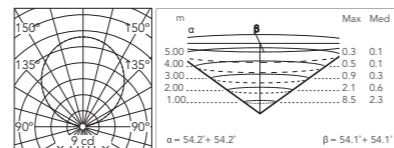

@ 3000K

* Numero massimo di apparecchi per alimentatore / Maximum number of luminaires per power supply.

Numero massimo di apparecchi per alimentatore (Vin220÷240). Dati indicativi da verificare con le specifiche condizioni di installazione.	Maximum number of luminaires per power supply. (220÷240 V). These data must be checked taking into account the specific installation conditions.	Acc. RF25754	1	Acc. RF25752	5
		Acc. RF25748	1	Acc. RF25755	14
		Acc. RF25747	4	Acc. RF25749	29
		Acc. RF25757	4		

C-Me Round 70

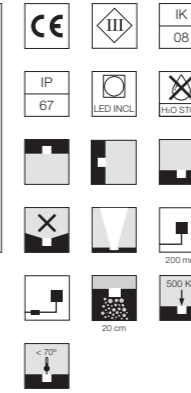
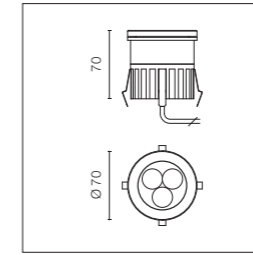

Sorgente a LED inclusa. Alimentazione elettrica remota 24V dc da ordinare separatamente. Necessaria cassaforma da ordinare separatamente. Dotato di spezzone di cavo uscente in neoprene 200 mm con sistema integrato di giunzione H2O STOP e kit con connettori crimp e guaina termorestringente adesiva per connessione a tenuta stagna. Vetro trasparente extrachiaro. Versione dimmerabile a richiesta.

LED source included. 24V dc remote electric power supply to be ordered separately. Requires a junction box to be ordered separately. The luminaire is equipped with a protruding, neoprene, 200 mm cable with an integrated H2O STOP connection system and a wiring kit with crimp connectors and adhesive heat-shrink tubing guaranteeing the water tightness of the connection. Extra clear transparent glass. Adjustable light intensity version available upon request.

Optic Spot 10°

Power Led: 5,9W - 431 lm ≠ OUTPUT 359 lm - 2700K/CRI 80 - 24Vdc / 5,9W - 466 lm ≠ OUTPUT 389 lm - 3000K/CRI 80 - 24Vdc / 5,9W - 484 lm ≠ OUTPUT 404 lm - 4000K/CRI 80 - 24Vdc

2700K	3000K	4000K
FA10018212	FA10017912	FA10018012

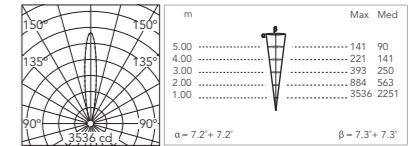

@ 3000K

Optic Medium 30°

Power Led: 5,9W - 431 lm ≠ OUTPUT 364 lm - 2700K/CRI 80 - 24Vdc / 5,9W - 466 lm ≠ OUTPUT 395 lm - 3000K/CRI 80 - 24Vdc / 5,9W - 484 lm ≠ OUTPUT 410 lm - 4000K/CRI 80 - 24Vdc

2700K	3000K	4000K
FA10018230	FA10017930	FA10018030

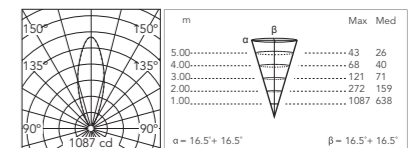

@ 3000K

Optic Flood 50°

Power Led: 5,9W - 431 lm ≠ OUTPUT 329 lm - 2700K/CRI 80 - 24Vdc / 5,9W - 466 lm ≠ OUTPUT 357 lm - 3000K/CRI 80 - 24Vdc / 5,9W - 484 lm ≠ OUTPUT 371 lm - 4000K/CRI 80 - 24Vdc

2700K	3000K	4000K
FA10018240	FA10017940	FA10018040

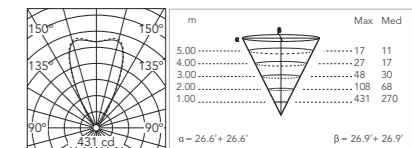

@ 3000K

C-Me Opal Round 70

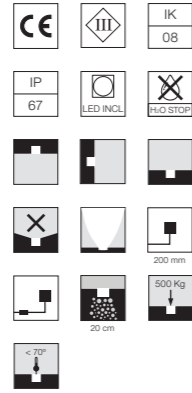
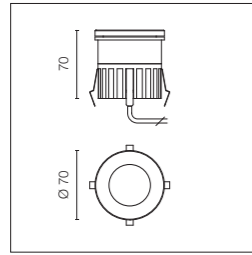

Sorgente a LED inclusa. Alimentazione elettrica remota 24V dc da ordinare separatamente. Necessaria cassaforma da ordinare separatamente. Dotato di spezzone di cavo uscente in neoprene 200 mm con sistema integrato di giunzione H2O STOP e kit con connettori crimp e guaina termorestringente adesiva per connessione a tenuta stagna. Vetro con diffusore opale. Dimmerabile.

LED source included. 24V dc remote electric power supply to be ordered separately. Requires a junction box to be ordered separately. The luminaire is equipped with a protruding, neoprene, 200 mm cable with an integrated H2O STOP connection system and a wiring kit with crimp connectors and adhesive heat-shrink tubing guaranteeing the water tightness of the connection. Glass with opal diffuser. Adjustable light intensity.

Diffused Light

Mid-Power Led: 5,9W - 127 lm ≠ OUTPUT 80 lm - 2700K/CRI 80 - 24Vdc / 5,9W - 131 lm ≠ OUTPUT 82 lm - 3000K/CRI 80 - 24Vdc / 8,9W - 136 lm ≠ OUTPUT 83 lm - 4000K/CRI 80 - 24Vdc

2700K	3000K	4000K
FA100182122	FA100179122	FA100180122

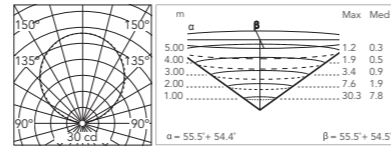

@ 3000K

* Numero massimo di apparecchi per alimentatore / Maximum number of luminaires per power supply.

Numero massimo di apparecchi per alimentatore (Vin220÷240). Dati indicativi da verificare con le specifiche condizioni di installazione.	Maximum number of luminaires per power supply. (220÷240 V). These data must be checked taking into account the specific installation conditions.	Acc. RF25747	1	Acc. RF25755	6
		Acc. RF25757	1	Acc. RF25749	12
		Acc. RF25752	2		

C-Me Opal Round 70 RGB

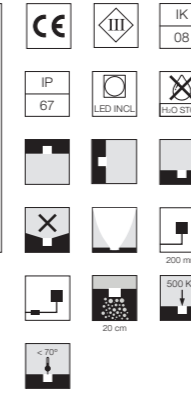
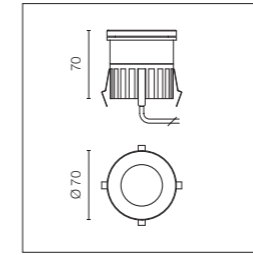

Sorgente a LED inclusa. Alimentazione elettrica remota con interfaccia DMX 3chx350mA da ordinare separatamente. Necessaria cassaforma da ordinare separatamente. Dotato di spezzone di cavo uscente in neoprene 200 mm e kit con connettori crimp e guaina termorestringente adesiva per connessione a tenuta stagna. Vetro con diffusore opale.

LED source included. Remote electric power supply with DMX 3chx350mA interface, to be ordered separately. Requires a junction box to be ordered separately. The luminaire is equipped with a protruding, neoprene, 200 mm cable and a wiring kit with crimp connectors and adhesive heat-shrink tubing guaranteeing the water tightness of the connection. Glass with opal diffuser.

Schema elettrico e installazione sistema RGB.

Massimo 10 apparecchi C-Me Opal Round 70 LED RGB per ogni codice F990B22A000.

Vedere Schema Elettrico n.5 Page 670.

Wiring diagram and installation scheme RGB.

Max 10 luminaires C-Me Opal Round 70 LED RGB for each code F990B22A000.

See Wiring Diagram n.5 Page 670.

Diffused Light

RGB Power Led: 3,4W - 3CH x 350mA

RGB

FA100174122

Photometric data on request.

* Numero massimo di apparecchi per alimentatore / Maximum number of luminaires per power supply.

Numero massimo di apparecchi per alimentatore (Vin220÷240). Dati indicativi da verificare con le specifiche condizioni di installazione.	Maximum number of luminaires per power supply. (220÷240 V). These data must be checked taking into account the specific installation conditions.	Acc. F990B22A000	**10	**La tensione ai capi del sistema è in funzione del numero di apparecchi collegati in serie, attenersi alle norme CEI 64-8.	**The voltage at the end of the system depends on the number of fixtures connected in series, please comply with CEI 64-8 standards.
--	--	------------------	------	---	--

C-Me Round 70 RGB

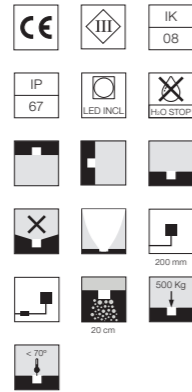
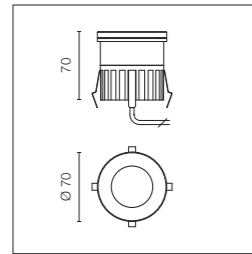

Sorgente a LED inclusa. Alimentazione elettrica remota con interfaccia DMX 3chx350mA da ordinare separatamente. Necessaria cassaforma da ordinare separatamente. Dotato di spezzone di cavo uscente in neoprene 200 mm e kit con connettori crimp e guaina termorestringente adesiva per connessione a tenuta stagna. Vetro trasparente extrachiaro.

LED source included. Remote electric power supply with DMX 3chx350mA interface, to be ordered separately. Requires a junction box to be ordered separately. The luminaire is equipped with a protruding, neoprene, 200 mm cable and a wiring kit with crimp connectors and adhesive heat-shrink tubing guaranteeing the water tightness of the connection. Extra clear transparent glass.

Schema elettrico e installazione sistema RGB.

Massimo 10 apparecchi C-Me Round 70 LED RGB per ogni codice F990B22A000

Vedere Schema Elettrico n.5 Page 670.

Wiring diagram and installation scheme RGB.

Max 10 luminaires C-Me Round 70 LED RGB for each code F990B22A000.

See Wiring Diagram n.5 Page 670.

RGB Power Led: 3,4W - 3CH x 350mA

Optic Spot 10°

FA10017412

Optic Medium 35°

FA10017440

Photometric data on request.

C-Me Square 40

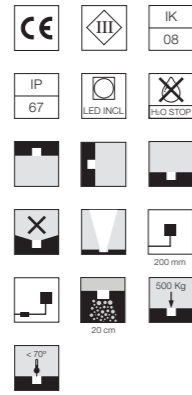
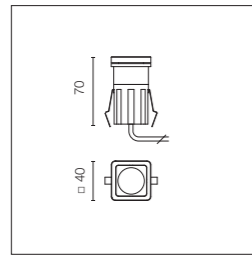

Sorgente a LED inclusa. Alimentazione elettrica remota 24V dc da ordinare separatamente. Necessaria cassaforma da ordinare separatamente. Dotato di spezzone di cavo uscente in neoprene 200 mm e kit con connettori crimp e guaina termorestringente adesiva per connessione a tenuta stagna. Vetro trasparente extrachiaro. Versione dimmerabile a richiesta.

LED source included. 24V dc remote electric power supply to be ordered separately. Requires a junction box to be ordered separately. The luminaire is equipped with a protruding, neoprene, 200 mm cable and a wiring kit with crimp connectors and adhesive heat-shrink tubing guaranteeing the water tightness of the connection. Extra clear transparent glass. Adjustable light intensity version available upon request.

Optic Spot 10°

Power Led: 2,3W - 144 lm ≠ OUTPUT 111 lm - 2700K/CRI 80 -24Vdc / 2,3W - 155 lm ≠ OUTPUT 121 lm - 3000K/CRI 80 -24Vdc / 2,3W - 161 lm ≠ OUTPUT 125 lm - 4000K/CRI 80 -24Vdc

2700K	3000K	4000K
FA100181133	FA100176133	FA100177133

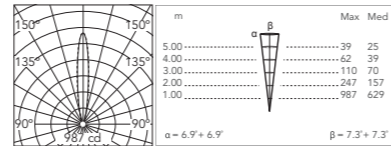

@ 3000K

Optic Medium 45°

Power Led: 2,3W - 144 lm ≠ OUTPUT 102 lm - 2700K/CRI 80 -24Vdc / 2,3W - 155 lm ≠ OUTPUT 110 lm - 3000K/CRI 80 -24Vdc / 2,3W - 161 lm ≠ OUTPUT 114 lm - 4000K/CRI 80 -24Vdc

2700K	3000K	4000K
FA10018141	FA10017641	FA10017741

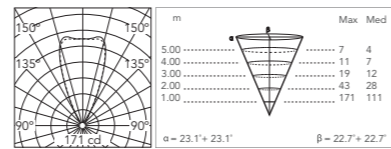

@ 3000K

C-Me Opal Square 40

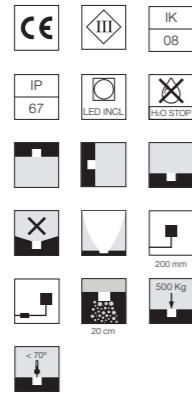
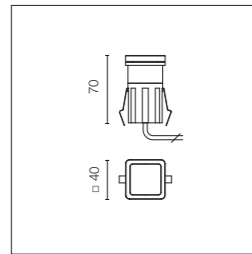

Sorgente a LED inclusa. Alimentazione elettrica remota 24V dc da ordinare separatamente. Necessaria cassaforma da ordinare separatamente. Dotato di spezzone di cavo uscente in neoprene 200 mm e kit con connettori crimp e guaina termorestringente adesiva per connessione a tenuta stagna. Vetro con diffusore opale. Dimmerabile.

LED source included. 24V dc remote electric power supply to be ordered separately. Requires a junction box to be ordered separately. The luminaire is equipped with a protruding, neoprene, 200 mm cable and a wiring kit with crimp connectors and adhesive heat-shrink tubing guaranteeing the water tightness of the connection. Glass with opal diffuser. Adjustable light intensity.

Diffused Light

Mid-Power Led: 2,3W - 42 lm ≠ OUTPUT 22 lm - 2700K/CRI 80 -24Vdc / 2,3W - 44 lm ≠ OUTPUT 23 lm - 3000K/CRI 80 -24Vdc / 2,3W - 45 lm ≠ OUTPUT 23 lm - 4000K/CRI 80 -24Vdc

2700K	3000K	4000K
FA100181124	FA100176124	FA100177124

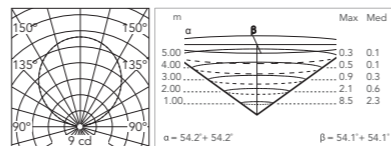

@ 3000K

* Numero massimo di apparecchi per alimentatore / Maximum number of luminaires per power supply.

Numero massimo di apparecchi per alimentatore (Vin220÷240). Dati indicativi da verificare con le specifiche condizioni di installazione.	Maximum number of luminaires per power supply. (220÷240 V). These data must be checked taking into account the specific installation conditions.	Acc. RF25754	1	Acc. RF25752	5
		Acc. RF25748	1	Acc. RF25755	14
		Acc. RF25747	4	Acc. RF25749	29
		Acc. RF25757	4		

C-Me Square 70

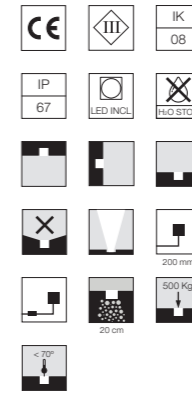
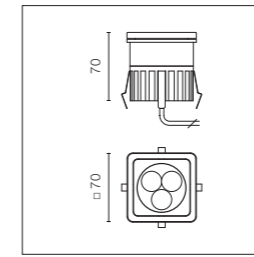

Sorgente a LED inclusa. Alimentazione elettrica remota 24V dc da ordinare separatamente. Necessaria cassaforma da ordinare separatamente. Dotato di spezzone di cavo uscente in neoprene 200 mm con sistema integrato di giunzione H2O STOP e kit con connettori crimp e guaina termorestringente adesiva per connessione a tenuta stagna. Vetro trasparente extrachiaro. Versione dimmerabile a richiesta.

LED source included. 24V dc remote electric power supply to be ordered separately. Requires a junction box to be ordered separately. The luminaire is equipped with a protruding, neoprene, 200 mm cable with an integrated H2O STOP connection system and a wiring kit with crimp connectors and adhesive heat-shrink tubing guaranteeing the water tightness of the connection. Extra clear transparent glass. Adjustable light intensity version available upon request.

Optic Spot 10°

Power Led: 5,9W - 431 lm ≠ OUTPUT 359 lm - 2700K/CRI 80 - 24Vdc / 5,9W - 466 lm ≠ OUTPUT 389 lm - 3000K/CRI 80 - 24Vdc / 5,9W - 484 lm ≠ OUTPUT 404 lm - 4000K/CRI 80 - 24Vdc

2700K	3000K	4000K
FA100182132	FA100179132	FA100180132

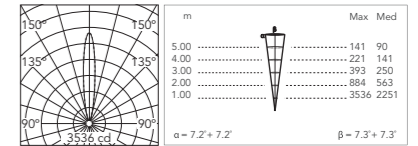

@ 3000K

Optic Medium 30°

Power Led: 5,9W - 431 lm ≠ OUTPUT 364 lm - 2700K/CRI 80 - 24Vdc / 5,9W - 466 lm ≠ OUTPUT 395 lm - 3000K/CRI 80 - 24Vdc / 5,9W - 484 lm ≠ OUTPUT 410 lm - 4000K/CRI 80 - 24Vdc

2700K	3000K	4000K
FA100182130	FA100179130	FA100180130

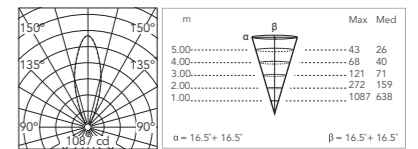

@ 3000K

Optic Flood 50°

Power Led: 5,9W - 431 lm ≠ OUTPUT 329 lm - 2700K/CRI 80 - 24Vdc / 5,9W - 466 lm ≠ OUTPUT 357 lm - 3000K/CRI 80 - 24Vdc / 5,9W - 484 lm ≠ OUTPUT 371 lm - 4000K/CRI 80 - 24Vdc

2700K	3000K	4000K
FA10018241	FA10017941	FA10018041

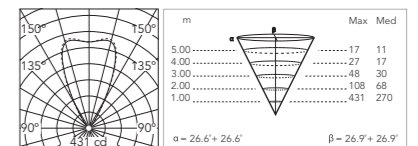

@ 3000K

C-Me Opal Square 70

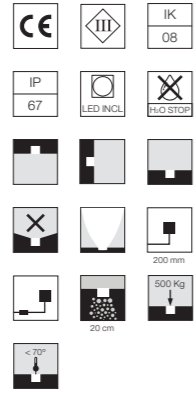
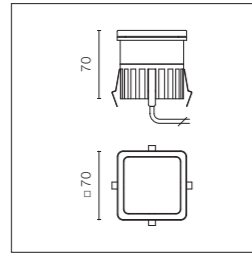

Sorgente a LED inclusa. Alimentazione elettrica remota 24V dc da ordinare separatamente. Necessaria cassaforma da ordinare separatamente. Dotato di spezzone di cavo uscente in neoprene 200 mm con sistema integrato di giunzione H2O STOP e kit con connettori crimp e guaina termorestringente adesiva per connessione a tenuta stagna. Vetro con diffusore opale. Dimmerabile.

LED source included. 24V dc remote electric power supply to be ordered separately. Requires a junction box to be ordered separately. The luminaire is equipped with a protruding, neoprene, 200 mm cable with an integrated H2O STOP connection system and a wiring kit with crimp connectors and adhesive heat-shrink tubing guaranteeing the water tightness of the connection. Glass with opal diffuser. Adjustable light intensity.

Diffused Light

Mid-Power Led: 5,9W - 127 lm ≠ OUTPUT 80 lm - 2700K/CRI 80 - 24Vdc / 5,9W - 131 lm ≠ OUTPUT 82 lm - 3000K/CRI 80 - 24Vdc / 8,9W - 136 lm ≠ OUTPUT 83 lm - 4000K/CRI 80 - 24Vdc

2700K

FA100182125

3000K

FA100179125

4000K

FA100180125

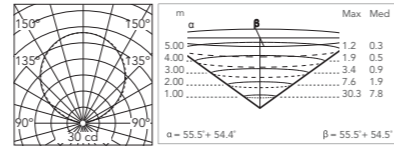

* Numero massimo di apparecchi per alimentatore / Maximum number of luminaires per power supply.

Numero massimo di apparecchi per alimentatore (Vin220÷240). Dati indicativi da verificare con le specifiche condizioni di installazione.

Maximum number of luminaires per power supply. (220÷240 V). These data must be checked taking into account the specific installation conditions.

Acc. RF25747	1
Acc. RF25757	1
Acc. RF25752	2

Acc. RF25755	6
Acc. RF25749	12

C-Me Square 70 RGB

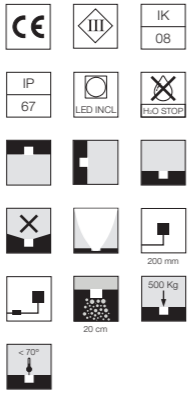
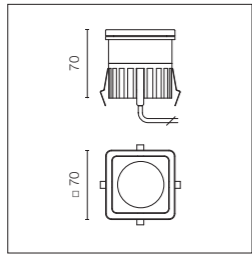

Sorgente a LED inclusa. Alimentazione elettrica remota con interfaccia DMX 3chx350mA da ordinare separatamente. Necessaria cassaforma da ordinare separatamente. Dotato di spezzone di cavo uscente in neoprene 200 mm e kit con connettori crimp e guaina termorestringente adesiva per connessione a tenuta stagna. Vetro trasparente extrachiaro.

LED source included. Remote electric power supply with DMX 3chx350mA interface, to be ordered separately. Requires a junction box to be ordered separately. The luminaire is equipped with a protruding, neoprene, 200 mm cable and a wiring kit with crimp connectors and adhesive heat-shrink tubing guaranteeing the water tightness of the connection. Extra clear transparent glass.

Schema elettrico e installazione sistema RGB.

Massimo 10 apparecchi C-Me Square 70 LED RGB per ogni codice F990B22A000

Vedere Schema Elettrico n.5 Page 670.

Wiring diagram and installation scheme RGB.

Max 10 luminaires C-Me Square 70 LED RGB for each code F990B22A000.

See Wiring Diagram n.5 Page 670.

RGB Power Led: 3,4W - 3CH x 350mA

Optic Spot 10°

FA100174132

Optic Medium 35°

FA10017441

Photometric data on request.

C-Me Opal Square 70 RGB

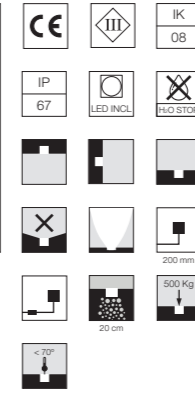
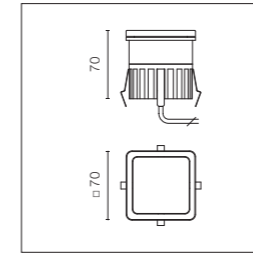

Sorgente RGB a LED inclusa. Alimentazione elettrica remota con interfaccia DMX 3chx350mA da ordinare separatamente. Necessaria cassaforma da ordinare separatamente. Dotato di spezzone di cavo uscente in neoprene 200 mm e kit con connettori crimp e guaina termorestringente adesiva per connessione a tenuta stagna. Vetro con diffusore opale.

LED source included. Remote electric power supply with DMX 3chx350mA interface, to be ordered separately. Requires a junction box to be ordered separately. The luminaire is equipped with a protruding, neoprene, 200 mm cable and a wiring kit with crimp connectors and adhesive heat-shrink tubing guaranteeing the water tightness of the connection. Glass with opal diffuser.

Schema elettrico e installazione sistema RGB.

Massimo 10 apparecchi C-Me Opal Square 70 LED RGB per ogni codice F990B22A000.

Vedere Schema Elettrico n.5 Page 670.

Wiring diagram and installation scheme RGB.

Max 10 luminaires C-Me Opal Square 70 LED RGB for each code F990B22A000.

See Wiring Diagram n.5 Page 670.

Diffused Light

RGB Power Led: 3,4W - 3CH x 350mA

RGB

FA100174125

Photometric data on request.

* Numero massimo di apparecchi per alimentatore / Maximum number of luminaires per power supply.

Numero massimo di apparecchi per alimentatore (Vin220÷240). Dati indicativi da verificare con le specifiche condizioni di installazione.

Maximum number of luminaires per power supply. (220÷240 V). These data must be checked taking into account the specific installation conditions.

Acc. F990B22A000 **10

**La tensione ai capi del sistema è in funzione del numero di apparecchi collegati in serie, attenersi alle norme CEI 64-8.

**The voltage at the end of the system depends on the number of fixtures connected in series, please comply with CEI 64-8 standards.

C-Me: Accessori / Accessories

Scatola per incasso. Box for installation.

C-Me Ø40
FA98

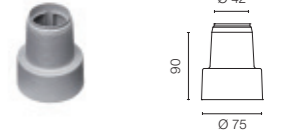

Scatola per incasso. Box for installation.

C-Me 40x40
FA99

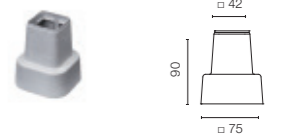

Scatola per incasso. Box for installation.

C-Me Ø70
FA101

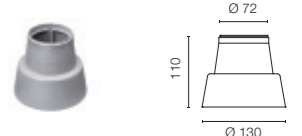

Scatola per incasso. Box for installation.

C-Me 70x70
FA102

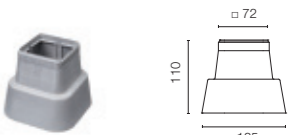

Sistema di giunzione IP68 a 2 vie 2 poli. (Ø4÷6,9mm cavo).

2 way terminal block 2 poles IP68. (Ø4÷6,9mm cable).



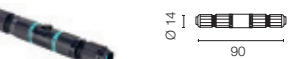







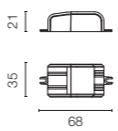

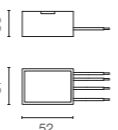

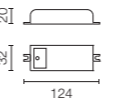
F990C050000

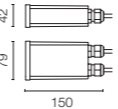

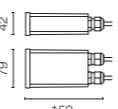

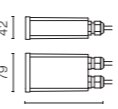

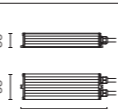

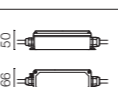
Non può essere alloggiato nella scatola per incasso.

It can't be placed in the recessed box for installation.

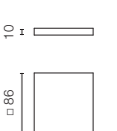
C-Me: Driver / Drivers

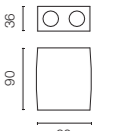
Alimentatore doppia funzione Vout 24Vdc: 8W/100÷240V Iout 350ma: 6x1W/100÷240V IP20 Classe II Selv Eq.	Power supply dual function Vout 24Vdc: 8W/100÷240V Iout 350ma: 6x1W/100÷240V IP20 Class II Selv Eq.	C-Me 40mm *RF25754		
Alimentatore 24V 8W / 110-240V IP65 Classe II selv.	Power supply 24V 8W / 110-240V IP65 Class II selv.	C-Me 40mm *RF25748		
Alimentatore 24V 10W / 110-240V IP20 Classe II selv.	Power supply 24V 10W / 110-240V IP20 Class II selv.	*RF25747		
Alimentatore 24V 10W / 110-240V IP67 Classe II selv.	Power supply 24V 10W / 110-240V IP67 Class II selv.	*RF25757		
Alimentatore per installazione remota 24Vdc 20W / 220-240V IP67 Classe II selv.	Power supply for remote installation 24Vdc 20W / 220-240V IP67 Class II selv.	*RF25752		
Alimentatore 24Vdc 35W / 120-270V IP67 Classe II selv.	Power supply 24Vdc 35W / 120-270V IP67 Class II selv.	F990B23AZ00		
Alimentatore 24Vdc 50W / 120-240V IP67 Classe II selv.	Power supply 24Vdc 50W / 120-240V IP67 Class II selv.	*RF25755		
Alimentatore 24Vdc 70W / 220-240V IP67 Classe II selv.	Power supply 24Vdc 70W / 220-240V IP67 Class II selv.	*RF25749		

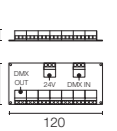
C-Me RGB: Accessori / Accessories

Controller DMX a parete per scatole ad incasso (60mm interasse fori).	DMX controller; dimmer switch for recessed box (60mm hole centres).	F990B10A000		
Controller DMX stand-alone/interfaccia pc.	DMX controller; stand-alone/pc interface.	F990B11A000		
DMX splitter 512 - dispositivo elettronico per rigenerare segnale dmx monodirezionale 1 Input e 7 output, 12-24Vdc. Alimentatore non incluso.	DMX splitter 512 - electronic device to regenerate the monodirectional DMX signal 1 Input and 7 output, 12-24Vdc. Power supply not included.	F990B13A000		
Cavo DMX schermato con impedenza costante 110 Ohm.	DMX cable - shielded twisted pair with 110 Ohm constant impedance.	F990B12A000		

C-Me RGB: Driver / Drivers

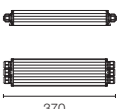
Alimentatore con interfaccia DMX per apparecchi RGB 36W/220÷240V-3CH x 350mA (3CH x 10 x 1W) predisposizione DMX IP67 Classe I Selv Eq.	Power supply with DMX interface for RGB fixtures 36W/220÷240v-3CH x 350mA (3CH x 10 x 1W) DMX control allowed IP67 Class I Selv Eq.	*F990B22A000		
---	---	--------------	--	--

C-Me Square 100

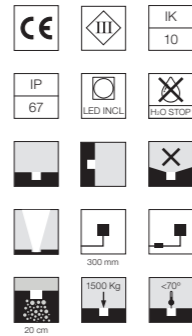
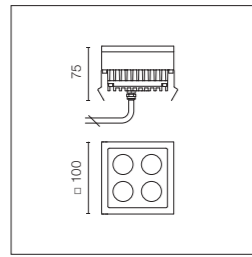

Sorgente a LED inclusa. Alimentazione elettrica remota 24V dc da ordinare separatamente. Necessaria cassaforma da ordinare separatamente. Dotato di spezzone di cavo uscente in neoprene 300 mm e kit con connettori crimp e guaina termorestringente adesiva per connessione a tenuta stagna. Vetro trasparente extrachiaro.

LED source included. 24V dc remote electric power supply to be ordered separately. Requires a junction box to be ordered separately. The luminaire is equipped with a protruding, neoprene, 300 mm cable and a wiring kit with crimp connectors and adhesive heat-shrink tubing guaranteeing the water tightness of the connection. Extra clear transparent glass.

Optic Spot 10°

Power Led: 7,5W - 773 lm ≠ OUTPUT 575 lm - 2700K/CRI 80 - 24Vdc / 7,5W - 828 lm ≠ OUTPUT 616 lm - 3000K/CRI 80 - 24Vdc / 7,5W - 856 lm ≠ OUTPUT 636 lm - 4000K/CRI 80 -24Vdc

2700K FA524015	3000K FA524013	4000K FA524012
--------------------------	--------------------------	--------------------------

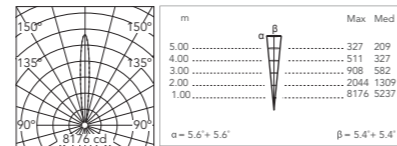

@ 3000K

Optic Medium 40°

Power Led: 7,5W - 773 lm ≠ OUTPUT 529 lm - 2700K/CRI 80 - 24Vdc / 7,5W - 828 lm ≠ OUTPUT 567 lm - 3000K/CRI 80 - 24Vdc / 7,5W - 856 lm ≠ OUTPUT 586 lm - 4000K/CRI 80 -24Vdc

2700K FA524025	3000K FA524023	4000K FA524022
--------------------------	--------------------------	--------------------------

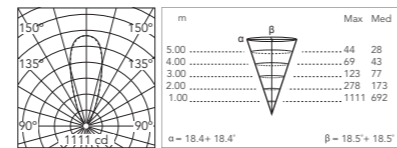

@ 3000K

* Numero massimo di apparecchi per alimentatore / Maximum number of luminaires per power supply.

Numero massimo di apparecchi per alimentatore (Vin220÷240). Dati indicativi da verificare con le specifiche condizioni di installazione.	Maximum number of luminaires per power supply. (220÷240 V). These data must be checked taking into account the specific installation conditions.	Acc. RF25747	1
		Acc. RF25757	1
		Acc. RF25755	5
		Acc. RF25749	8

C-Me Opal Square 100

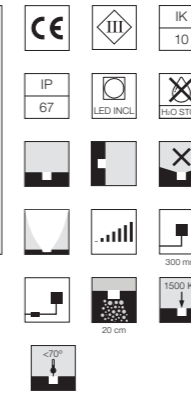
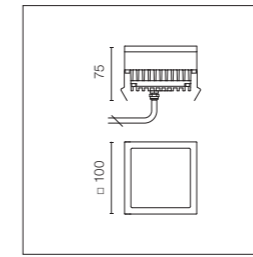

Sorgente a LED inclusa. Alimentazione elettrica remota 24V dc da ordinare separatamente. Necessaria cassaforma da ordinare separatamente. Dotato di spezzone di cavo uscente in neoprene 300 mm e kit con connettori crimp e guaina termorestringente adesiva per connessione a tenuta stagna. Vetro con diffusore opale. Dimmerabile.

LED source included. 24V dc remote electric power supply to be ordered separately. Requires a junction box to be ordered separately. The luminaire is equipped with a protruding, neoprene, 300 mm cable and a wiring kit with crimp connectors and adhesive heat-shrink tubing guaranteeing the water tightness of the connection. Glass with opal diffuser. Adjustable light intensity.

Diffused Light

Mid-Power Led: 6,8W - 720 lm ≠ OUTPUT 396 lm - 2700K/CRI 80 - 24Vdc / 6,8W - 774 lm ≠ OUTPUT 426 lm - 3000K/CRI 80 - 24Vdc / 6,8W - 813 lm ≠ OUTPUT 447 lm - 4000K/CRI 80 -24Vdc

2700K FA524005	3000K FA524003	4000K FA524002
--------------------------	--------------------------	--------------------------

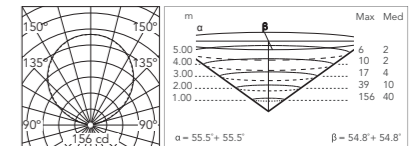

@ 3000K

* Numero massimo di apparecchi per alimentatore / Maximum number of luminaires per power supply.

Numero massimo di apparecchi per alimentatore (Vin220÷240). Dati indicativi da verificare con le specifiche condizioni di installazione.	Maximum number of luminaires per power supply. (220÷240 V). These data must be checked taking into account the specific installation conditions.	Acc. RF25747	1	Acc. RF25752	2
		Acc. RF25757	1	Acc. RF25755	6
		Acc. RF25750	2	Acc. RF25749	9
		Acc. F990B21A000	2	Acc. RF25756	13
		Acc. RF26387	1		

C-Me Opal Square 100 RGB

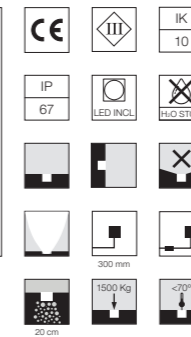
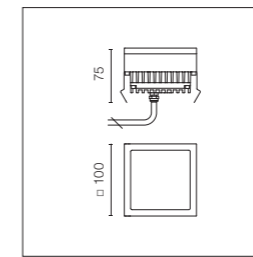

Sorgente RGB a LED inclusa. Alimentazione elettrica remota con interfaccia DMX 3chx24Vdc da ordinare separatamente. Necessaria cassaforma da ordinare separatamente. Dotato di spezzone di cavo uscente in neoprene 300 mm e kit con connettori crimp e guaina termorestringente adesiva per connessione a tenuta stagna. Vetro con diffusore opale.

LED RGB light source included. Remote electric power supply with DMX 3chx24Vdc interface, to be ordered separately. Requires a junction box to be ordered separately. The luminaire is equipped with a protruding, neoprene, 300 mm cable and a wiring kit with crimp connectors and adhesive heat-shrink tubing guaranteeing the water tightness of the connection. Glass with opal diffuser.

Diffused Light

RGB Power Led: 6W - 3CH x 24Vdc

RGB
FA524004

Photometric data on request.

Schema elettrico e installazione sistema RGB.

Massimo 8 apparecchi C-Me Square 100 RGB per ogni codice FA148.

Vedere Schema Elettrico n.6 Page 670.

Wiring diagram and installation scheme RGB.

Max 8 luminaires C-Me Square 100 RGB for each code FA148.

See Wiring Diagram n.6 Page 670.

* Numero massimo di apparecchi per alimentatore / Maximum number of luminaires per power supply.

Numero massimo di apparecchi per alimentatore (Vin220÷240). Dati indicativi da verificare con le specifiche condizioni di installazione.	Maximum number of luminaires per power supply. (220÷240 V). These data must be checked taking into account the specific installation conditions.	Acc. FA148	8
--	--	------------	---

C-Me Rectangle

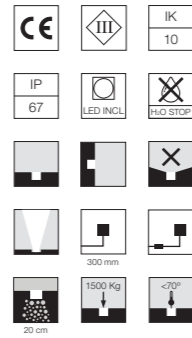
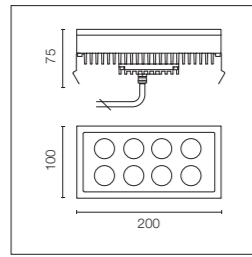

Sorgente a LED inclusa. Alimentazione elettrica remota 24V dc da ordinare separatamente. Necessaria cassaforma da ordinare separatamente. Dotato di spezzone di cavo uscente in neoprene 300 mm e kit con connettori crimp e guaina termorestringente adesiva per connessione a tenuta stagna. Vetro trasparente extrachiaro.

LED source included. 24V dc remote electric power supply to be ordered separately. Requires a junction box to be ordered separately. The luminaire is equipped with a protruding, neoprene, 300 mm cable and a wiring kit with crimp connectors and adhesive heat-shrink tubing guaranteeing the water tightness of the connection. Extra clear transparent glass.

Optic Spot 10°

Power Led: 15W - 1546 lm ≠ OUTPUT 1150 lm - 2700K/CRI 80 - 24Vdc / 15W - 1656 lm ≠ OUTPUT 1232 lm - 3000K/CRI 80 - 24Vdc / 15W - 1711 lm ≠ OUTPUT 1273 lm - 4000K/CRI 80 -24Vdc

2700K	3000K	4000K
FA524515	FA524513	FA524512

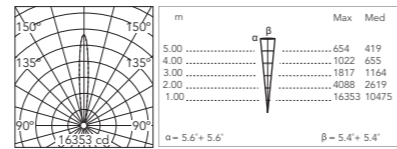

@ 3000K

Optic Medium 40°

Power Led: 15W - 1546 lm ≠ OUTPUT 1059 lm - 2700K/CRI 80 - 24Vdc / 15W - 1656 lm ≠ OUTPUT 1134 lm - 3000K/CRI 80 - 24Vdc / 15W - 1711 lm ≠ OUTPUT 1172 lm - 4000K/CRI 80 -24Vdc

2700K	3000K	4000K
FA524525	FA524523	FA524522

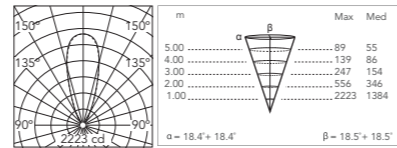

@ 3000K

* Numero massimo di apparecchi per alimentatore / Maximum number of luminaires per power supply.

Numero massimo di apparecchi per alimentatore (Vin220+240). Dati indicativi da verificare con le specifiche condizioni di installazione.	Maximum number of luminaires per power supply. (220+240 V). These data must be checked taking into account the specific installation conditions.	Acc. RF25752	1
		Acc. RF25755	2
		Acc. RF25749	4

C-Me Opal Rectangle

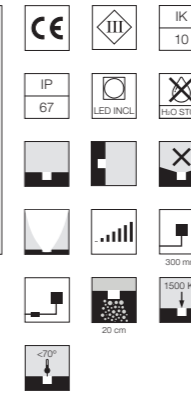
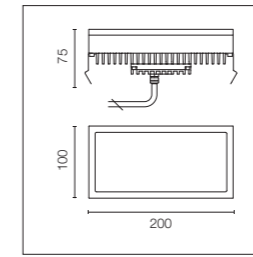

Sorgente a LED inclusa. Alimentazione elettrica remota 24V dc da ordinare separatamente. Necessaria cassaforma da ordinare separatamente. Dotato di spezzone di cavo uscente in neoprene 300 mm e kit con connettori crimp e guaina termorestringente adesiva per connessione a tenuta stagna. Vetro con diffusore opale. Dimmerabile.

LED source included. 24V dc remote electric power supply to be ordered separately. Requires a junction box to be ordered separately. The luminaire is equipped with a protruding, neoprene, 300 mm cable and a wiring kit with crimp connectors and adhesive heat-shrink tubing guaranteeing the water tightness of the connection. Glass with opal diffuser. Adjustable light intensity.

Diffused Light

Mid-Power Led: 15,8W - 1620 lm ≠ OUTPUT 939 lm - 2700K/CRI 80 - 24Vdc / 15,8W - 1734 lm ≠ OUTPUT 1009 lm - 3000K/CRI 80 - 24Vdc / 15,8W - 1742 lm ≠ OUTPUT 1060 lm - 4000K/CRI 80 -24Vdc

2700K	3000K	4000K
FA524505	FA524503	FA524502

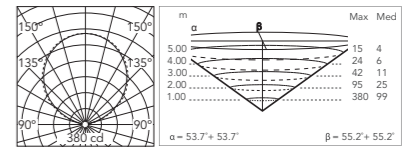

@ 3000K

* Numero massimo di apparecchi per alimentatore / Maximum number of luminaires per power supply.

Numero massimo di apparecchi per alimentatore (Vin220+240). Dati indicativi da verificare con le specifiche condizioni di installazione.	Maximum number of luminaires per power supply. (220+240 V). These data must be checked taking into account the specific installation conditions.	Acc. RF25750	1	Acc. RF25755	3
		Acc. F990B21A000	1	Acc. RF25749	4
		Acc. RF26387	1	Acc. RF25756	6
		Acc. RF25752	1		

C-Me Opal Rectangle RGB

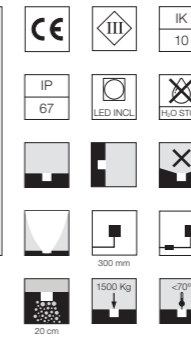
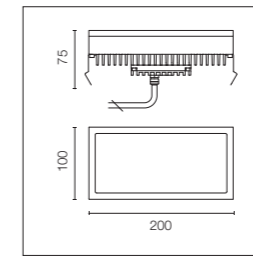

Sorgente RGB a LED inclusa. Alimentazione elettrica remota con interfaccia DMX 3chx24Vdc da ordinare separatamente. Necessaria cassaforma da ordinare separatamente. Dotato di spezzone di cavo uscente in neoprene 300 mm e kit con connettori crimp e guaina termorestringente adesiva per connessione a tenuta stagna. Vetro con diffusore opale.

LED RGB light source included. Remote electric power supply with DMX 3chx24Vdc interface, to be ordered separately. Requires a junction box to be ordered separately. The luminaire is equipped with a protruding, neoprene, 300 mm cable and a wiring kit with crimp connectors and adhesive heat-shrink tubing guaranteeing the water tightness of the connection. Glass with opal diffuser.

Diffused Light

RGB Power Led: 10,5W - 3CH x 24Vdc

RGB
FA524504

Photometric data on request.

Schema elettrico e installazione sistema RGB.

Massimo 4 apparecchi C-Me Rectangle 100 RGB per ogni codice FA148.

Vedere Schema Elettrico n.6 Page 670.

Wiring diagram and installation scheme RGB.

Max 4 luminaires C-Me Rectangle LED RGB for each code FA148.

See Wiring Diagram n.6 Page 670.

* Numero massimo di apparecchi per alimentatore / Maximum number of luminaires per power supply.

Numero massimo di apparecchi per alimentatore (Vin220+240). Dati indicativi da verificare con le specifiche condizioni di installazione.	Maximum number of luminaires per power supply. (220+240 V). These data must be checked taking into account the specific installation conditions.	Acc. FA148	4
--	--	------------	---

C-Me Line

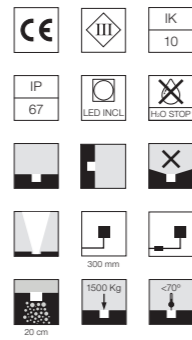
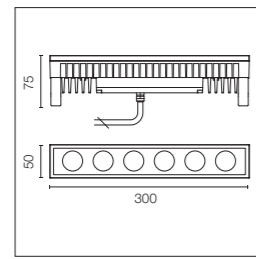

Sorgente a LED inclusa. Alimentazione elettrica remota 24V dc da ordinare separatamente. Necessaria cassaforma da ordinare separatamente. Dotato di spezzone di cavo uscente in neoprene 300 mm e kit con connettori crimp e guaina termorestringente adesiva per connessione a tenuta stagna. Vetro trasparente extrachiaro.

LED source included. 24V dc remote electric power supply to be ordered separately. Requires a junction box to be ordered separately. The luminaire is equipped with a protruding, neoprene, 300 mm cable and a wiring kit with crimp connectors and adhesive heat-shrink tubing guaranteeing the water tightness of the connection. Extra clear transparent glass.

Optic Spot 10°

Power Led: 11,8W - 1159 lm ≠ OUTPUT 862 lm - 2700K/CRI 80 - 24Vdc / 11,8W - 1242 lm ≠ OUTPUT 924 lm - 3000K/CRI 80 - 24Vdc / 11,8W - 1283 lm ≠ OUTPUT 955 lm - 4000K/CRI 80 - 24Vdc

2700K	3000K	4000K
FA524115	FA524113	FA524112

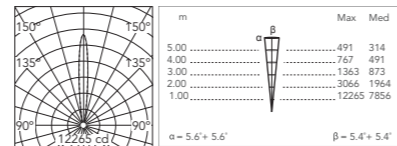

@ 3000K

Optic Medium 40°

Power Led: 11,8W - 1159 lm ≠ OUTPUT 794 lm - 2700K/CRI 80 - 24Vdc / 11,8W - 1242 lm ≠ OUTPUT 851 lm - 3000K/CRI 80 - 24Vdc / 11,8W - 1283 lm ≠ OUTPUT 879 lm - 4000K/CRI 80 - 24Vdc

2700K	3000K	4000K
FA524125	FA524123	FA524122

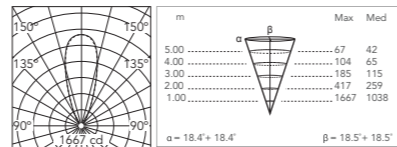

@ 3000K

* Numero massimo di apparecchi per alimentatore / Maximum number of luminaires per power supply.

Numero massimo di apparecchi per alimentatore (Vin220÷240). Dati indicativi da verificare con le specifiche condizioni di installazione.	Maximum number of luminaires per power supply. (220÷240 V). These data must be checked taking into account the specific installation conditions.	Acc. RF25752	1
		Acc. RF25755	3
		Acc. RF25749	6

C-Me Opal Line

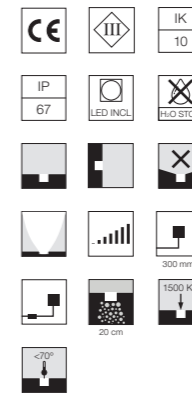
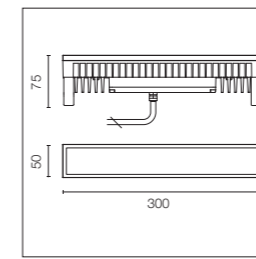

Sorgente a LED inclusa. Alimentazione elettrica remota 24V dc da ordinare separatamente. Necessaria cassaforma da ordinare separatamente. Dotato di spezzone di cavo uscente in neoprene 300 mm e kit con connettori crimp e guaina termorestringente adesiva per connessione a tenuta stagna. Vetro con diffusore opale. Dimmerabile.

LED source included. 24V dc remote electric power supply to be ordered separately. Requires a junction box to be ordered separately. The luminaire is equipped with a protruding, neoprene, 300 mm cable and a wiring kit with crimp connectors and adhesive heat-shrink tubing guaranteeing the water tightness of the connection. Glass with opal diffuser. Adjustable light intensity.

Diffused Light

Mid-Power Led: 10,5W - 1080 lm ≠ OUTPUT 538 lm - 2700K/CRI 80 - 24Vdc / 10,5W - 1161 lm ≠ OUTPUT 578 lm - 3000K/CRI 80 - 24Vdc / 10,5W - 1219 lm ≠ OUTPUT 607 lm - 4000K/CRI 80 - 24Vdc

2700K	3000K	4000K
FA524105	FA524103	FA524102

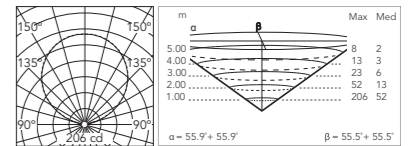

@ 3000K

* Numero massimo di apparecchi per alimentatore / Maximum number of luminaires per power supply.

Numero massimo di apparecchi per alimentatore (Vin220÷240). Dati indicativi da verificare con le specifiche condizioni di installazione.	Maximum number of luminaires per power supply. (220÷240 V). These data must be checked taking into account the specific installation conditions.	Acc. RF25750	1	Acc. RF25755	4
		Acc. F990B21A000 <td>1</td> <td>Acc. RF25749 <td>6</td> </td>	1	Acc. RF25749 <td>6</td>	6
		Acc. RF26387 <td>1</td> <td>Acc. RF25756 <td>9</td> </td>	1	Acc. RF25756 <td>9</td>	9
		Acc. RF25752 <td>1</td> <td></td> <td></td>	1		

C-Me Opal Line RGB

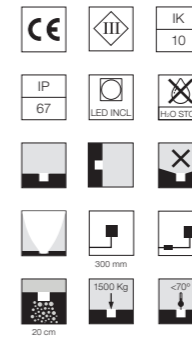
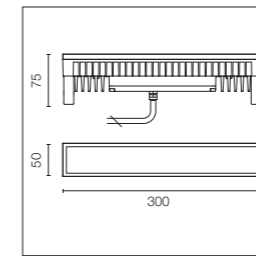

Sorgente RGB a LED inclusa. Alimentazione elettrica remota con interfaccia DMX 3chx24Vdc da ordinare separatamente. Necessaria cassaforma da ordinare separatamente. Dotato di spezzone di cavo uscente in neoprene 300 mm e kit con connettori crimp e guaina termorestringente adesiva per connessione a tenuta stagna. Vetro con diffusore opale.

LED RGB light source included. Remote electric power supply with DMX 3chx24Vdc interface, to be ordered separately. Requires a junction box to be ordered separately. The luminaire is equipped with a protruding, neoprene, 300 mm cable and a wiring kit with crimp connectors and adhesive heat-shrink tubing guaranteeing the water tightness of the connection. Glass with opal diffuser.

Diffused Light

RGB Power Led: 8W - 3CH x 24Vdc

RGB
FA524104

Photometric data on request.

Schema elettrico e installazione sistema RGB.

Massimo 5 apparecchi C-Me Line RGB per ogni codice FA148.

Vedere Schema Elettrico n.6 Page 670.

Wiring diagram and installation scheme RGB.











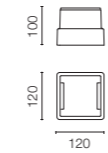

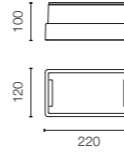

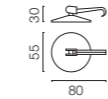

Max 5 luminaires C-Me Line RGB for each code FA148.

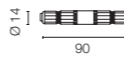
See Wiring Diagram n.6 Page 670.

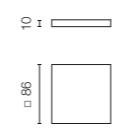

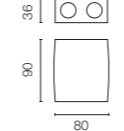

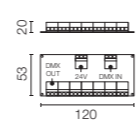





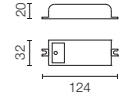

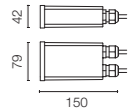

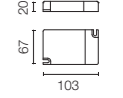

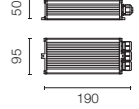

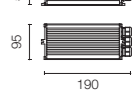

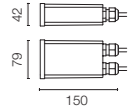
* Numero massimo di apparecchi per alimentatore / Maximum number of luminaires per power supply.

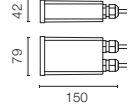
Numero massimo di apparecchi per alimentatore (Vin220÷240). Dati indicativi da verificare con le specifiche condizioni di installazione.	Maximum number of luminaires per power supply. (220÷240 V). These data must be checked taking into account the specific installation conditions.	Acc. FA148	5
--	--	------------	---

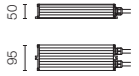
C-Me Square 100 / Rectangle / Line: Accessori / Accessories

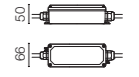
Scatola per incasso.	Box for installation.	C-Me Square 100 FA151		
Scatola per incasso.	Box for installation.	C-Me Rectangle FA152		
Scatola per incasso.	Box for installation.	C-Me Line FA183		
Ventosa per rimuovere l'apparecchio.	Suction cup to pull the luminaire.	FA153		
Sistema di giunzione IP68 a 2 vie 2 poli. (Ø4÷6,9mm cavo).	2 way terminal block 2 poles IP68. (Ø4÷6,9mm cable).	F990C050000		
Non può essere alloggiato nella scatola per incasso.	It can't be placed in the recessed box for installation.			
Controller DMX a parete per scatole ad incasso (60mm interasse fori).	DMX controller; dimmer switch for recessed box (60mm hole centres).	C-Me RGB F990B10A000		
Controller DMX stand-alone/interfaccia pc.	DMX controller; stand-alone/pc interface.	C-Me RGB F990B11A000		
DMX splitter 512 - dispositivo elettronico per rigenerare segnale dmx monodirezionale 1 Input e 7 output, 12-24Vdc. Alimentatore non incluso.	DMX splitter 512 - electronic device to regenerate the monodirectional DMX signal 1 Input and 7 output, 12-24Vdc. Power supply not included.	C-Me RGB F990B13A000		
Cavo DMX schermato con impedenza costante 110 Ohm.	DMX cable - shielded twisted pair with 110 Ohm constant impedance.	C-Me RGB F990B12A000		

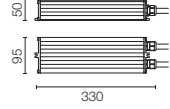
C-Me Square 100 / Rectangle / Line: Driver / Drivers

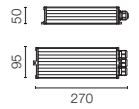
Alimentatore 24V 10W / 110-240V IP20 Classe II selv.	Power supply 24V 10W / 110-240V IP20 Class II selv.	*RF25747		
Alimentatore 24V 10W / 110-240V IP67 Classe II selv.	Power supply 24V 10W / 110-240V IP67 Class II selv.	*RF25757		
Alimentatore per installazione remota 24Vdc 17W / 110-240V (15W@110V) IP20 Classe II selv.	Power supply for remote installation 24Vdc 17W / 110-240V (15W@110V) IP20 Class II selv.	C-Me Square 100 Diffused Light *RF25750		
		 Dimmable Push-Dim Or 1-10V See Wiring Diagram n.4, Page 668		
Alimentatore 17W/110÷240V - 24Vdc (15W@110V) IP67 Classe II Selv.	Power supply 17W/110÷240V - 24Vdc (15W@110V) IP67 Class II Selv.	C-Me Square 100 Diffused Light *F990B21A000		
		 Dimmable Push-Dim Or 1-10V See Wiring Diagram n.4, Page 668		
Alimentatore per installazione remota 24Vdc 20W / 110-240Vdc (15W@110V) IP67 Classe II selv.	Power supply for remote installation 24Vdc 20W / 110-240Vdc (15W@110V) IP67 Class II selv.	C-Me Square 100 Diffused Light *RF26387		
		 Dimmable DALI See Wiring Diagram n.4, Page 668		
Alimentatore per installazione remota 24Vdc 20W / 220-240V IP67 Classe II selv.	Power supply for remote installation 24Vdc 20W / 220-240V IP67 Class II selv.	C-Me Square 100 Diffused Light *RF25752		
Alimentatore 24Vdc 35W / 120-270V IP67 Classe II selv.	Power supply 24Vdc 35W / 120-270V IP67 Class II selv.	F990B23AZ00		
Alimentatore per installazione remota 24Vdc 50W / 120-240V IP67 Classe II selv.	Power supply for remote installation 24Vdc 50W / 120-240V IP67 Class II selv.	*RF25755		
Alimentatore per installazione remota 24Vdc 70W / 220-240V IP67 Classe II selv.	Power supply for remote installation 24Vdc 70W / 220-240V IP67 Class II selv.	*RF25749		
Alimentatore per installazione remota 24Vdc 96W / 120-240V IP67 Classe II selv.	Power supply for remote installation 24Vdc 96W / 120-240V IP67 Class II selv.	*RF25756		
Alimentatore con interfaccia DMX. Per apparecchi RGB 55W/220÷230V-3CHx24Vdc (3CHx18W) predisposizione DMX IP67 Classe I Selv Eq.	Power supply with DMX interface for RGB fixtures 55W/220÷230V-3CHx24Vdc (3CHx18W) DMX controller allowed IP67 Class I Selv Eq.	C-Me RGB *FA148		

Outgraze



Designed by Flos Outdoor

Outgraze



Famiglia / Family

Outgraze 35 L 300



Power Led 7W 517 lm - 2700K/CRI 80 536 lm - 3000K/CRI 80 554 lm - 4000K/CRI 80	Easy Mid - Power Led 4,5W 190 lm - 2700K/CRI 80 207 lm - 3000K/CRI 80 223 lm - 4000K/CRI 80	Easy Tunable White Mid - Power Led 4,5W 95±120 lm - 2700K±5700K/CRI 80
---	--	---

Outgraze 35 L 600



Power Led 12W 1034 lm - 2700K/CRI 80 1071 lm - 3000K/CRI 80 1108 lm - 4000K/CRI 80	Easy Mid - Power Led 9W 381 lm - 2700K/CRI 80 414 lm - 3000K/CRI 80 447 lm - 4000K/CRI 80	Easy Tunable White Mid - Power Led 9W 190±240 lm - 2700K±5700K/CRI 80
---	--	--

Outgraze 35 L 900



Power Led 18W 1551 lm - 2700K/CRI 80 1807 lm - 3000K/CRI 80 1662 lm - 4000K/CRI 80	Easy Mid - Power Led 13W 571 lm - 2700K/CRI 80 621 lm - 3000K/CRI 80 670 lm - 4000K/CRI 80	Easy Tunable White Mid - Power Led 13W 285±360 lm - 2700K±5700K/CRI 80
---	---	---

Outgraze 35 L 1200



Power Led 23W 2089 lm - 2700K/CRI 80 2142 lm - 3000K/CRI 80 2216 lm - 4000K/CRI 80	Easy Mid - Power Led 17,5W 761 lm - 2700K/CRI 80 827 lm - 3000K/CRI 80 894 lm - 4000K/CRI 80	Easy Tunable White Mid - Power Led 17,5W 381±480 lm - 2700K±5700K/CRI 80
---	---	---

Outgraze 50 L 300



Power Led 8W 685 lm - 2700K/CRI 80 709 lm - 3000K/CRI 80 734 lm - 4000K/CRI 80	Easy Mid - Power Led 8W 310 lm - 2700K/CRI 80 337 lm - 3000K/CRI 80 364 lm - 4000K/CRI 80	Easy Tunable White Dali Mid - Power Led 6,5W 220 lm - 2700K/CRI 80
---	--	---

Outgraze 50 L 600



Power Led 14,5W 1369 lm - 2700K/CRI 80 1418 lm - 3000K/CRI 80 1467 lm - 4000K/CRI 80	Easy Mid - Power Led 14,5W 620 lm - 2700K/CRI 80 674 lm - 3000K/CRI 80 728 lm - 4000K/CRI 80	Easy Tunable White Dali Mid - Power Led 11W 440 lm - 2700K/CRI 80	RGB - Power Led 26W	RGBW - Power Led 24W	Tunable White - Dali Mid - Power Led 13W 722 lm - 2700±5700K/CRI 80
	Easy - Dali Mid - Power Led 14,5W 1106 lm - 2700K/CRI 80 1198 lm - 3000K/CRI 80 1290 lm - 4000K/CRI 80				

Outgraze 50 L 900



Power Led 20W 2054 lm - 2700K/CRI 80 2127 lm - 3000K/CRI 80 2201 lm - 4000K/CRI 80	Easy / Easy Dali Mid - Power Led 20W 930 lm - 2700K/CRI 80 1011 lm - 3000K/CRI 80 1092 lm - 4000K/CRI 80	Easy Tunable White Dali Mid - Power Led 16W 660 lm - 2700K/CRI 80	RGB - Power Led 37W	RGBW - Power Led 33W	Tunable White - Dali Mid - Power Led 18,5W 1082 lm - 2700K/CRI 80
---	---	--	-------------------------------	--------------------------------	--

Outgraze 50 L 1200



Power Led 27W 2739 lm - 2700K/CRI 80 2836 lm - 3000K/CRI 80 2934 lm - 4000K/CRI 80	Easy / Easy Dali Mid - Power Led 27W 1240 lm - 2700K/CRI 80 1348 lm - 3000K/CRI 80 1456 lm - 4000K/CRI 80	Easy Tunable White Dali Mid - Power Led 21W 879 lm - 2700K/CRI 80	RGB - Power Led 48W	RGBW - Power Led 43W	Tunable White - Dali Mid - Power Led 23W 1443 lm - 2700K/CRI 80
---	--	--	-------------------------------	--------------------------------	--

Descrizione / Description

Apparecchio da esterni per installazione a parete o soffitto con fonte di luce a LED.

Corpo centrale in alluminio estruso, estremità di chiusura in alluminio pressofuso.

Ottiche realizzate con passo costante tra le lenti per offrire flusso luminoso omogeneo anche in caso di più lampade installate in una Continuous Line.

Rivestimento esterno ad alta resistenza applicato con un doppio strato con polveri secondo lo standard QUALICOAT.

Il primo strato di polvere epossidica dà resistenza chimica e meccanica, il secondo strato di finitura di polvere poliestere assicura resistenza ai raggi UV ed agli agenti atmosferici.

Le superfici verniciate sono trattate con lavaggi alcalini e acidi, risciacquate con acqua demineralizzata e sottoposte a un trattamento di conversione chimica per proteggere contro l'ossidazione.

Diffusore in vetro trasparente extra chiaro o sabbiato serigrafato e incollato per garantire la tenuta all'acqua.

L'installazione del prodotto prevede l'uso obbligatorio di staffe in acciaio, da ordinare separatamente.

Apparecchi forniti con uno spezzone di cavo in neoprene di circa 1000 mm uscente su un lato.

Disponibile versione degli apparecchi con collegamento passante per installazione multipla con continuità di linea.

Luminaire for outdoor use for installation on the wall or ceiling with LED light source.

Central body in extruded aluminum, end cap in die-cast aluminum.

Optics made with constant pitch between the lenses to offer a homogeneous luminous flux even in case of multiple lamps installed in a continuous line.

High resistance external coating applied with a double layer of epoxy powders in accordance with the QUALICOAT standard. The first layer of epoxy powder gives chemical and mechanical resistance, the second finishing layer of polyester powder ensures resistance to UV rays and atmospheric agents.

The painted surfaces are treated with alkaline and acidic washes, then rinsed with demineralized water, subjected to a chemical conversion treatment to protect against oxidation.

Diffuser in extra clear transparent glass or sandblasted glass, screen-printed and glued to ensure a watertight seal.

The installation of the product requires use of steel brackets, to be ordered separately.

Luminaire provided with a length of approximately 1000 mm of outgoing neoprene cable on one side.

Available versions of luminaires with loop-through connection for multiple installation with continuity of line.



Colori / Colours

Outgraze



01 White



06 Grey



12 Forest Green



18 Deep Brown



30 Black



33 Anthracite

Outgraze 35 L 300

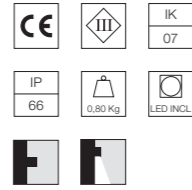
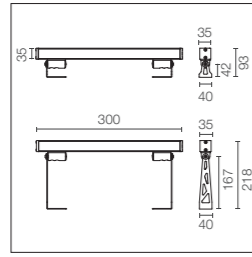

Alimentazione elettrica remota 48V e staffe di installazione da ordinare separatamente. Vetro trasparente extra chiaro, esclusa versione DIFFUSED con vetro sabbato. Apparecchi dimmerabili PWM. A richiesta versione SMART (potenza 4W - flusso -50% lm).

48V remote power supply and installation brackets to be ordered separately. Extra clear transparent glass, excluding the DIFFUSE version with sandblasted glass. Dimmable PWM luminaires. SMART version available upon request (power 4W - flux -50% lm).

Power Led: 7W - 696 lm ≠ *FIXT 517 lm - 2700K/CRI 80 - 48V / 7W - 720 lm ≠ *FIXT 536 lm - 3000K/CRI 80 - 48V / 7W - 745 lm ≠ *FIXT 554 lm - 4000K/CRI 80 - 48V
 *FIXT lm = Medium Optic

¹Standard - Schema elettrico n.1 page 436 / Wiring diagram n.1 page 436

- | | | |
|---------------|---------------|---------------|
| 2700K | 3000K | 4000K |
| ○ F020A21H001 | ○ F020A31H001 | ○ F020A41H001 |
| ● F020A21H006 | ● F020A31H006 | ● F020A41H006 |
| ● F020A21H012 | ● F020A31H012 | ● F020A41H012 |
| ● F020A21H018 | ● F020A31H018 | ● F020A41H018 |
| ● F020A21H030 | ● F020A31H030 | ● F020A41H030 |
| ● F020A21H033 | ● F020A31H033 | ● F020A41H033 |

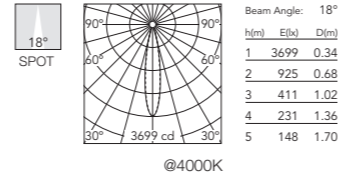

²Quick Install I H2O Stop Fast Connect - Schema elettrico n.2 page 436 / Wiring diagram n.2 page 436

- | | | |
|---------------|---------------|---------------|
| 2700K | 3000K | 4000K |
| ○ F020B21H001 | ○ F020B31H001 | ○ F020B41H001 |
| ● F020B21H006 | ● F020B31H006 | ● F020B41H006 |
| ● F020B21H012 | ● F020B31H012 | ● F020B41H012 |
| ● F020B21H018 | ● F020B31H018 | ● F020B41H018 |
| ● F020B21H030 | ● F020B31H030 | ● F020B41H030 |
| ● F020B21H033 | ● F020B31H033 | ● F020B41H033 |

¹Standard - Schema elettrico n.1 page 436 / Wiring diagram n.1 page 436

- | | | |
|---------------|---------------|---------------|
| 2700K | 3000K | 4000K |
| ○ F020A25H001 | ○ F020A35H001 | ○ F020A45H001 |
| ● F020A25H006 | ● F020A35H006 | ● F020A45H006 |
| ● F020A25H012 | ● F020A35H012 | ● F020A45H012 |
| ● F020A25H018 | ● F020A35H018 | ● F020A45H018 |
| ● F020A25H030 | ● F020A35H030 | ● F020A45H030 |
| ● F020A25H033 | ● F020A35H033 | ● F020A45H033 |

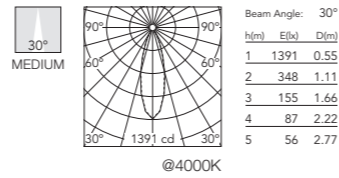

²Quick Install I H2O Stop Fast Connect - Schema elettrico n.2 page 436 / Wiring diagram n.2 page 436

- | | | |
|---------------|---------------|---------------|
| 2700K | 3000K | 4000K |
| ○ F020B25H001 | ○ F020B35H001 | ○ F020B45H001 |
| ● F020B25H006 | ● F020B35H006 | ● F020B45H006 |
| ● F020B25H012 | ● F020B35H012 | ● F020B45H012 |
| ● F020B25H018 | ● F020B35H018 | ● F020B45H018 |
| ● F020B25H030 | ● F020B35H030 | ● F020B45H030 |
| ● F020B25H033 | ● F020B35H033 | ● F020B45H033 |

¹Standard - Schema elettrico n.1 page 436 / Wiring diagram n.1 page 436

- | | | |
|---------------|---------------|---------------|
| 2700K | 3000K | 4000K |
| ○ F020A2AH001 | ○ F020A3AH001 | ○ F020A4AH001 |
| ● F020A2AH006 | ● F020A3AH006 | ● F020A4AH006 |
| ● F020A2AH012 | ● F020A3AH012 | ● F020A4AH012 |
| ● F020A2AH018 | ● F020A3AH018 | ● F020A4AH018 |
| ● F020A2AH030 | ● F020A3AH030 | ● F020A4AH030 |
| ● F020A2AH033 | ● F020A3AH033 | ● F020A4AH033 |

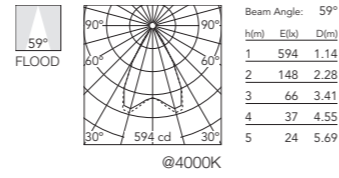

²Quick Install I H2O Stop Fast Connect - Schema elettrico n.2 page 436 / Wiring diagram n.2 page 436

- | | | |
|---------------|---------------|---------------|
| 2700K | 3000K | 4000K |
| ○ F020B2AH001 | ○ F020B3AH001 | ○ F020B4AH001 |
| ● F020B2AH006 | ● F020B3AH006 | ● F020B4AH006 |
| ● F020B2AH012 | ● F020B3AH012 | ● F020B4AH012 |
| ● F020B2AH018 | ● F020B3AH018 | ● F020B4AH018 |
| ● F020B2AH030 | ● F020B3AH030 | ● F020B4AH030 |
| ● F020B2AH033 | ● F020B3AH033 | ● F020B4AH033 |

¹Standard - Schema elettrico n.1 page 436 / Wiring diagram n.1 page 436

- | | | |
|---------------|---------------|---------------|
| 2700K | 3000K | 4000K |
| ○ F020A2EH001 | ○ F020A3EH001 | ○ F020A4EH001 |
| ● F020A2EH006 | ● F020A3EH006 | ● F020A4EH006 |
| ● F020A2EH012 | ● F020A3EH012 | ● F020A4EH012 |
| ● F020A2EH018 | ● F020A3EH018 | ● F020A4EH018 |
| ● F020A2EH030 | ● F020A3EH030 | ● F020A4EH030 |
| ● F020A2EH033 | ● F020A3EH033 | ● F020A4EH033 |

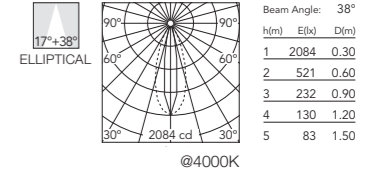

²Quick Install I H2O Stop Fast Connect - Schema elettrico n.2 page 436 / Wiring diagram n.2 page 436

- | | | |
|---------------|---------------|---------------|
| 2700K | 3000K | 4000K |
| ○ F020B2EH001 | ○ F020B3EH001 | ○ F020B4EH001 |
| ● F020B2EH006 | ● F020B3EH006 | ● F020B4EH006 |
| ● F020B2EH012 | ● F020B3EH012 | ● F020B4EH012 |
| ● F020B2EH018 | ● F020B3EH018 | ● F020B4EH018 |
| ● F020B2EH030 | ● F020B3EH030 | ● F020B4EH030 |
| ● F020B2EH033 | ● F020B3EH033 | ● F020B4EH033 |

¹Standard - Schema elettrico n.1 page 436 / Wiring diagram n.1 page 436

- | | | |
|---------------|---------------|---------------|
| 2700K | 3000K | 4000K |
| ○ F020A2JH001 | ○ F020A3JH001 | ○ F020A4JH001 |
| ● F020A2JH006 | ● F020A3JH006 | ● F020A4JH006 |
| ● F020A2JH012 | ● F020A3JH012 | ● F020A4JH012 |
| ● F020A2JH018 | ● F020A3JH018 | ● F020A4JH018 |
| ● F020A2JH030 | ● F020A3JH030 | ● F020A4JH030 |
| ● F020A2JH033 | ● F020A3JH033 | ● F020A4JH033 |

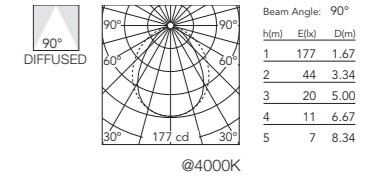

²Quick Install I H2O Stop Fast Connect - Schema elettrico n.2 page 436 / Wiring diagram n.2 page 436

- | | | |
|---------------|---------------|---------------|
| 2700K | 3000K | 4000K |
| ○ F020B2JH001 | ○ F020B3JH001 | ○ F020B4JH001 |
| ● F020B2JH006 | ● F020B3JH006 | ● F020B4JH006 |
| ● F020B2JH012 | ● F020B3JH012 | ● F020B4JH012 |
| ● F020B2JH018 | ● F020B3JH018 | ● F020B4JH018 |
| ● F020B2JH030 | ● F020B3JH030 | ● F020B4JH030 |
| ● F020B2JH033 | ● F020B3JH033 | ● F020B4JH033 |

¹Standard Version: spezzone di cavo in uscita 1000 mm (accessori per collegamento da ordinare) / 1000 mm lenght prewired cable (connecting accessory to be separately ordered).

²Quick Install In H2O Stop Version: connettore H2O Stop Plug&Play preinstallato per connessione rapida (accessori per collegamento da ordinare) / Prewired H2O Stop Plug&Play connector for an easy/rapid connection (connecting accessory to be ordered separately).

Outgraze 35 L 600

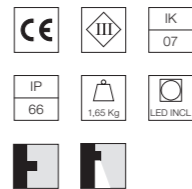
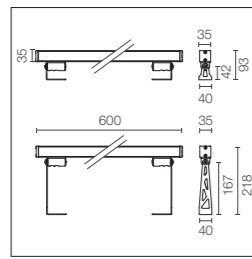

Alimentazione elettrica remota 48V e staffe di installazione da ordinare separatamente. Vetro trasparente extra chiaro, esclusa versione DIFFUSED con vetro sabbato. Apparecchi dimmerabili PWM. A richiesta versione SMART (potenza 7W - flusso -50% lm).

48V remote power supply and installation brackets to be ordered separately. Extra clear transparent glass, excluding the DIFFUSE version with sandblasted glass. Dimmable PWM luminaires. SMART version available upon request (power 7W - flux -50% lm).

Power Led: 12W - 1391 lm ≠ *FIXT 1034 lm - 2700K/CRI 80 - 48V / 12W - 1441 lm ≠ *FIXT 1071 lm - 3000K/CRI 80 - 48V / 12W - 1490 lm ≠ *FIXT 1108 lm - 4000K/CRI 80 - 48V
*FIXT lm = Medium Optic

¹Standard - Schema elettrico n.1 page 436 / Wiring diagram n.1 page 436

- | | | |
|---------------|---------------|---------------|
| 2700K | 3000K | 4000K |
| ○ F020A22H001 | ○ F020A32H001 | ○ F020A42H001 |
| ● F020A22H006 | ● F020A32H006 | ● F020A42H006 |
| ● F020A22H012 | ● F020A32H012 | ● F020A42H012 |
| ● F020A22H018 | ● F020A32H018 | ● F020A42H018 |
| ● F020A22H030 | ● F020A32H030 | ● F020A42H030 |
| ● F020A22H033 | ● F020A32H033 | ● F020A42H033 |

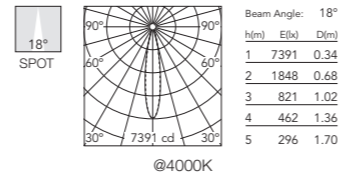

²Quick Install I H2O Stop Fast Connect - Schema elettrico n.2 page 436 / Wiring diagram n.2 page 436

- | | | |
|---------------|---------------|---------------|
| 2700K | 3000K | 4000K |
| ○ F020B22H001 | ○ F020B32H001 | ○ F020B42H001 |
| ● F020B22H006 | ● F020B32H006 | ● F020B42H006 |
| ● F020B22H012 | ● F020B32H012 | ● F020B42H012 |
| ● F020B22H018 | ● F020B32H018 | ● F020B42H018 |
| ● F020B22H030 | ● F020B32H030 | ● F020B42H030 |
| ● F020B22H033 | ● F020B32H033 | ● F020B42H033 |

³Continuous Line I/O H2O Stop Fast Connect - Schema elettrico n.3 page 436 / Wiring diagram n.3 page 436

- | | | |
|---------------|---------------|---------------|
| 2700K | 3000K | 4000K |
| ○ F020C22H001 | ○ F020C32H001 | ○ F020C42H001 |
| ● F020C22H006 | ● F020C32H006 | ● F020C42H006 |
| ● F020C22H012 | ● F020C32H012 | ● F020C42H012 |
| ● F020C22H018 | ● F020C32H018 | ● F020C42H018 |
| ● F020C22H030 | ● F020C32H030 | ● F020C42H030 |
| ● F020C22H033 | ● F020C32H033 | ● F020C42H033 |

¹Standard - Schema elettrico n.1 page 436 / Wiring diagram n.1 page 436

- | | | |
|---------------|---------------|---------------|
| 2700K | 3000K | 4000K |
| ○ F020A26H001 | ○ F020A36H001 | ○ F020A46H001 |
| ● F020A26H006 | ● F020A36H006 | ● F020A46H006 |
| ● F020A26H012 | ● F020A36H012 | ● F020A46H012 |
| ● F020A26H018 | ● F020A36H018 | ● F020A46H018 |
| ● F020A26H030 | ● F020A36H030 | ● F020A46H030 |
| ● F020A26H033 | ● F020A36H033 | ● F020A46H033 |

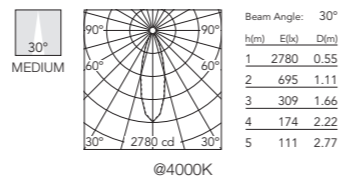

²Quick Install I H2O Stop Fast Connect - Schema elettrico n.2 page 436 / Wiring diagram n.2 page 436

- | | | |
|---------------|---------------|---------------|
| 2700K | 3000K | 4000K |
| ○ F020B26H001 | ○ F020B36H001 | ○ F020B46H001 |
| ● F020B26H006 | ● F020B36H006 | ● F020B46H006 |
| ● F020B26H012 | ● F020B36H012 | ● F020B46H012 |
| ● F020B26H018 | ● F020B36H018 | ● F020B46H018 |
| ● F020B26H030 | ● F020B36H030 | ● F020B46H030 |
| ● F020B26H033 | ● F020B36H033 | ● F020B46H033 |

³Continuous Line I/O H2O Stop Fast Connect - Schema elettrico n.3 page 436 / Wiring diagram n.3 page 436

- | | | |
|---------------|---------------|---------------|
| 2700K | 3000K | 4000K |
| ○ F020C26H001 | ○ F020C36H001 | ○ F020C46H001 |
| ● F020C26H006 | ● F020C36H006 | ● F020C46H006 |
| ● F020C26H012 | ● F020C36H012 | ● F020C46H012 |
| ● F020C26H018 | ● F020C36H018 | ● F020C46H018 |
| ● F020C26H030 | ● F020C36H030 | ● F020C46H030 |
| ● F020C26H033 | ● F020C36H033 | ● F020C46H033 |

¹Standard Version: spezzone di cavo in uscita 1000 mm (accessori per collegamento da ordinare) / 1000 mm length prewired cable (connecting accessory to be separately ordered).

²Quick Install In H2O Stop Version: connettore H2O Stop Plug&Play preinstallato per connessione rapida (accessori per collegamento da ordinare) / Prewired H2O Stop Plug&Play connector for an easy/rapid connection (connecting accessory to be ordered separately).

³Continuous Line In/Out H2O Stop Version: connettori H2O Stop Plug&Play preinstallati per connessione in linea (accessori per collegamento da ordinare) / Prewired H2O Stop Plug&Play connectors for an easy in line connection (connecting accessory to be ordered separately).

¹Standard - Schema elettrico n.1 page 436 / Wiring diagram n.1 page 436

- | | | |
|---------------|---------------|---------------|
| 2700K | 3000K | 4000K |
| ○ F020A2BH001 | ○ F020A3BH001 | ○ F020A4BH001 |
| ● F020A2BH006 | ● F020A3BH006 | ● F020A4BH006 |
| ● F020A2BH012 | ● F020A3BH012 | ● F020A4BH012 |
| ● F020A2BH018 | ● F020A3BH018 | ● F020A4BH018 |
| ● F020A2BH030 | ● F020A3BH030 | ● F020A4BH030 |
| ● F020A2BH033 | ● F020A3BH033 | ● F020A4BH033 |

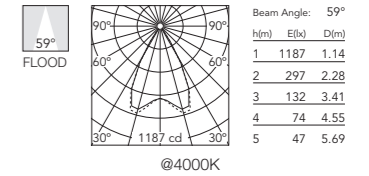

²Quick Install I H2O Stop Fast Connect - Schema elettrico n.2 page 436 / Wiring diagram n.2 page 436

- | | | |
|---------------|---------------|---------------|
| 2700K | 3000K | 4000K |
| ○ F020B2BH001 | ○ F020B3BH001 | ○ F020B4BH001 |
| ● F020B2BH006 | ● F020B3BH006 | ● F020B4BH006 |
| ● F020B2BH012 | ● F020B3BH012 | ● F020B4BH012 |
| ● F020B2BH018 | ● F020B3BH018 | ● F020B4BH018 |
| ● F020B2BH030 | ● F020B3BH030 | ● F020B4BH030 |
| ● F020B2BH033 | ● F020B3BH033 | ● F020B4BH033 |

³Continuous Line I/O H2O Stop Fast Connect - Schema elettrico n.3 page 436 / Wiring diagram n.3 page 436

- | | | |
|---------------|---------------|---------------|
| 2700K | 3000K | 4000K |
| ○ F020C2BH001 | ○ F020C3BH001 | ○ F020C4BH001 |
| ● F020C2BH006 | ● F020C3BH006 | ● F020C4BH006 |
| ● F020C2BH012 | ● F020C3BH012 | ● F020C4BH012 |
| ● F020C2BH018 | ● F020C3BH018 | ● F020C4BH018 |
| ● F020C2BH030 | ● F020C3BH030 | ● F020C4BH030 |
| ● F020C2BH033 | ● F020C3BH033 | ● F020C4BH033 |

¹Standard - Schema elettrico n.1 page 436 / Wiring diagram n.1 page 436

- | | | |
|---------------|---------------|---------------|
| 2700K | 3000K | 4000K |
| ○ F020A2FH001 | ○ F020A3FH001 | ○ F020A4FH001 |
| ● F020A2FH006 | ● F020A3FH006 | ● F020A4FH006 |
| ● F020A2FH012 | ● F020A3FH012 | ● F020A4FH012 |
| ● F020A2FH018 | ● F020A3FH018 | ● F020A4FH018 |
| ● F020A2FH030 | ● F020A3FH030 | ● F020A4FH030 |
| ● F020A2FH033 | ● F020A3FH033 | ● F020A4FH033 |

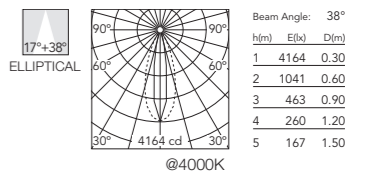

²Quick Install I H2O Stop Fast Connect - Schema elettrico n.2 page 436 / Wiring diagram n.2 page 436

- | | | |
|---------------|---------------|---------------|
| 2700K | 3000K | 4000K |
| ○ F020B2FH001 | ○ F020B3FH001 | ○ F020B4FH001 |
| ● F020B2FH006 | ● F020B3FH006 | ● F020B4FH006 |
| ● F020B2FH012 | ● F020B3FH012 | ● F020B4FH012 |
| ● F020B2FH018 | ● F020B3FH018 | ● F020B4FH018 |
| ● F020B2FH030 | ● F020B3FH030 | ● F020B4FH030 |
| ● F020B2FH033 | ● F020B3FH033 | ● F020B4FH033 |

³Continuous Line I/O H2O Stop Fast Connect - Schema elettrico n.3 page 436 / Wiring diagram n.3 page 436

- | | | |
|---------------|---------------|---------------|
| 2700K | 3000K | 4000K |
| ○ F020C2FH001 | ○ F020C3FH001 | ○ F020C4FH001 |
| ● F020C2FH006 | ● F020C3FH006 | ● F020C4FH006 |
| ● F020C2FH012 | ● F020C3FH012 | ● F020C4FH012 |
| ● F020C2FH018 | ● F020C3FH018 | ● F020C4FH018 |
| ● F020C2FH030 | ● F020C3FH030 | ● F020C4FH030 |
| ● F020C2FH033 | ● F020C3FH033 | ● F020C4FH033 |

¹Standard - Schema elettrico n.1 page 436 / Wiring diagram n.1 page 436

- | | | |
|---------------|---------------|---------------|
| 2700K | 3000K | 4000K |
| ○ F020A2KH001 | ○ F020A3KH001 | ○ F020A4KH001 |
| ● F020A2KH006 | ● F020A3KH006 | ● F020A4KH006 |
| ● F020A2KH012 | ● F020A3KH012 | ● F020A4KH012 |
| ● F020A2KH018 | ● F020A3KH018 | ● F020A4KH018 |
| ● F020A2KH030 | ● F020A3KH030 | ● F020A4KH030 |
| ● F020A2KH033 | ● F020A3KH033 | ● F020A4KH033 |

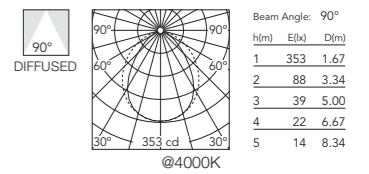

²Quick Install I H2O Stop Fast Connect - Schema elettrico n.2 page 436 / Wiring diagram n.2 page 436

- | | | |
|---------------|---------------|---------------|
| 2700K | 3000K | 4000K |
| ○ F020B2KH001 | ○ F020B3KH001 | ○ F020B4KH001 |
| ● F020B2KH006 | ● F020B3KH006 | ● F020B4KH006 |
| ● F020B2KH012 | ● F020B3KH012 | ● F020B4KH012 |
| ● F020B2KH018 | ● F020B3KH018 | ● F020B4KH018 |
| ● F020B2KH030 | ● F020B3KH030 | ● F020B4KH030 |
| ● F020B2KH033 | ● F020B3KH033 | ● F020B4KH033 |

³Continuous Line I/O H2O Stop Fast Connect - Schema elettrico n.3 page 436 / Wiring diagram n.3 page 436

- | | | |
|---------------|---------------|---------------|
| 2700K | 3000K | 4000K |
| ○ F020C2KH001 | ○ F020C3KH001 | ○ F020C4KH001 |
| ● F020C2KH006 | ● F020C3KH006 | ● F020C4KH006 |
| ● F020C2KH012 | ● F020C3KH012 | ● F020C4KH012 |
| ● F020C2KH018 | ● F020C3KH018 | ● F020C4KH018 |
| ● F020C2KH030 | ● F020C3KH030 | ● F020C4KH030 |
| ● F020C2KH033 | ● F020C3KH033 | ● F020C4KH033 |

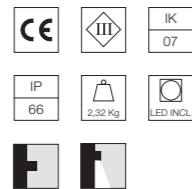
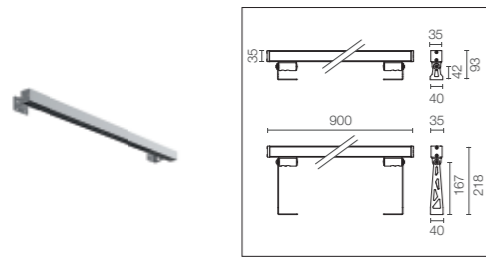

Alimentazione elettrica remota 48V e staffe di installazione da ordinare separatamente. Vetro trasparente extra chiaro, esclusa versione DIFFUSED con vetro sabbato. Apparecchi dimmerabili PWM. A richiesta versione SMART (potenza 11W - flusso -50% lm).

48V remote power supply and installation brackets to be ordered separately. Extra clear transparent glass, excluding the DIFFUSE version with sandblasted glass. Dimmable PWM luminaires. SMART version available upon request (power 11W - flux -50% lm).

Power Led: 18W - 2087 lm ≠ *FIXT 1551 lm - 2700K/CRI 80 - 48V / 18W - 2161 lm ≠ *FIXT 1607 lm - 3000K/CRI 80 - 48V / 18W - 2236 lm ≠ *FIXT 1662 lm - 4000K/CRI 80 - 48V
 *FIXT lm = Medium Optic

¹Standard - Schema elettrico n.1 page 436 / Wiring diagram n.1 page 436

- | | | |
|---------------|---------------|---------------|
| 2700K | 3000K | 4000K |
| ○ F020A23H001 | ○ F020A33H001 | ○ F020A43H001 |
| ● F020A23H006 | ● F020A33H006 | ● F020A43H006 |
| ● F020A23H012 | ● F020A33H012 | ● F020A43H012 |
| ● F020A23H018 | ● F020A33H018 | ● F020A43H018 |
| ● F020A23H030 | ● F020A33H030 | ● F020A43H030 |
| ● F020A23H033 | ● F020A33H033 | ● F020A43H033 |

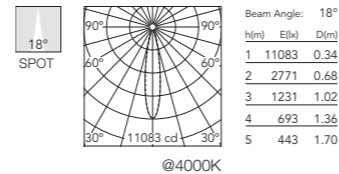

²Quick Install I H2O Stop Fast Connect - Schema elettrico n.2 page 436 / Wiring diagram n.2 page 436

- | | | |
|---------------|---------------|---------------|
| 2700K | 3000K | 4000K |
| ○ F020B23H001 | ○ F020B33H001 | ○ F020B43H001 |
| ● F020B23H006 | ● F020B33H006 | ● F020B43H006 |
| ● F020B23H012 | ● F020B33H012 | ● F020B43H012 |
| ● F020B23H018 | ● F020B33H018 | ● F020B43H018 |
| ● F020B23H030 | ● F020B33H030 | ● F020B43H030 |
| ● F020B23H033 | ● F020B33H033 | ● F020B43H033 |

³Continuous Line I/O H2O Stop Fast Connect - Schema elettrico n.3 page 436 / Wiring diagram n.3 page 436

- | | | |
|---------------|---------------|---------------|
| 2700K | 3000K | 4000K |
| ○ F020C23H001 | ○ F020C33H001 | ○ F020C43H001 |
| ● F020C23H006 | ● F020C33H006 | ● F020C43H006 |
| ● F020C23H012 | ● F020C33H012 | ● F020C43H012 |
| ● F020C23H018 | ● F020C33H018 | ● F020C43H018 |
| ● F020C23H030 | ● F020C33H030 | ● F020C43H030 |
| ● F020C23H033 | ● F020C33H033 | ● F020C43H033 |

¹Standard - Schema elettrico n.1 page 436 / Wiring diagram n.1 page 436

- | | | |
|---------------|---------------|---------------|
| 2700K | 3000K | 4000K |
| ○ F020A27H001 | ○ F020A37H001 | ○ F020A47H001 |
| ● F020A27H006 | ● F020A37H006 | ● F020A47H006 |
| ● F020A27H012 | ● F020A37H012 | ● F020A47H012 |
| ● F020A27H018 | ● F020A37H018 | ● F020A47H018 |
| ● F020A27H030 | ● F020A37H030 | ● F020A47H030 |
| ● F020A27H033 | ● F020A37H033 | ● F020A47H033 |

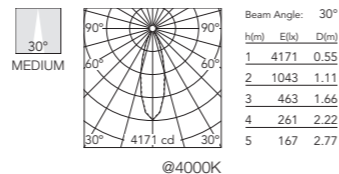

²Quick Install I H2O Stop Fast Connect - Schema elettrico n.2 page 436 / Wiring diagram n.2 page 436

- | | | |
|---------------|---------------|---------------|
| 2700K | 3000K | 4000K |
| ○ F020B27H001 | ○ F020B37H001 | ○ F020B47H001 |
| ● F020B27H006 | ● F020B37H006 | ● F020B47H006 |
| ● F020B27H012 | ● F020B37H012 | ● F020B47H012 |
| ● F020B27H018 | ● F020B37H018 | ● F020B47H018 |
| ● F020B27H030 | ● F020B37H030 | ● F020B47H030 |
| ● F020B27H033 | ● F020B37H033 | ● F020B47H033 |

³Continuous Line I/O H2O Stop Fast Connect - Schema elettrico n.3 page 436 / Wiring diagram n.3 page 436

- | | | |
|---------------|---------------|---------------|
| 2700K | 3000K | 4000K |
| ○ F020C27H001 | ○ F020C37H001 | ○ F020C47H001 |
| ● F020C27H006 | ● F020C37H006 | ● F020C47H006 |
| ● F020C27H012 | ● F020C37H012 | ● F020C47H012 |
| ● F020C27H018 | ● F020C37H018 | ● F020C47H018 |
| ● F020C27H030 | ● F020C37H030 | ● F020C47H030 |
| ● F020C27H033 | ● F020C37H033 | ● F020C47H033 |

¹Standard Version: spezzone di cavo in uscita 1000 mm (accessori per collegamento da ordinare) / 1000 mm length prewired cable (connecting accessory to be separately ordered).

²Quick Install In H2O Stop Version: connettore H2O Stop Plug&Play preinstallato per connessione rapida (accessori per collegamento da ordinare) / Prewired H2O Stop Plug&Play connector for an easy/rapid connection (connecting accessory to be ordered separately).

³Continuous Line In/Out H2O Stop Version: connettori H2O Stop Plug&Play preinstallati per connessione in linea (accessori per collegamento da ordinare) / Prewired H2O Stop Plug&Play connectors for an easy in line connection (connecting accessory to be ordered separately).

¹Standard - Schema elettrico n.1 page 436 / Wiring diagram n.1 page 436

- | | | |
|---------------|---------------|---------------|
| 2700K | 3000K | 4000K |
| ○ F020A2CH001 | ○ F020A3CH001 | ○ F020A4CH001 |
| ● F020A2CH006 | ● F020A3CH006 | ● F020A4CH006 |
| ● F020A2CH012 | ● F020A3CH012 | ● F020A4CH012 |
| ● F020A2CH018 | ● F020A3CH018 | ● F020A4CH018 |
| ● F020A2CH030 | ● F020A3CH030 | ● F020A4CH030 |
| ● F020A2CH033 | ● F020A3CH033 | ● F020A4CH033 |

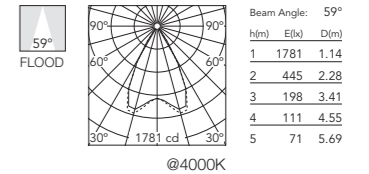

²Quick Install I H2O Stop Fast Connect - Schema elettrico n.2 page 436 / Wiring diagram n.2 page 436

- | | | |
|---------------|---------------|---------------|
| 2700K | 3000K | 4000K |
| ○ F020B2CH001 | ○ F020B3CH001 | ○ F020B4CH001 |
| ● F020B2CH006 | ● F020B3CH006 | ● F020B4CH006 |
| ● F020B2CH012 | ● F020B3CH012 | ● F020B4CH012 |
| ● F020B2CH018 | ● F020B3CH018 | ● F020B4CH018 |
| ● F020B2CH030 | ● F020B3CH030 | ● F020B4CH030 |
| ● F020B2CH033 | ● F020B3CH033 | ● F020B4CH033 |

³Continuous Line I/O H2O Stop Fast Connect - Schema elettrico n.3 page 436 / Wiring diagram n.3 page 436

- | | | |
|---------------|---------------|---------------|
| 2700K | 3000K | 4000K |
| ○ F020C2CH001 | ○ F020C3CH001 | ○ F020C4CH001 |
| ● F020C2CH006 | ● F020C3CH006 | ● F020C4CH006 |
| ● F020C2CH012 | ● F020C3CH012 | ● F020C4CH012 |
| ● F020C2CH018 | ● F020C3CH018 | ● F020C4CH018 |
| ● F020C2CH030 | ● F020C3CH030 | ● F020C4CH030 |
| ● F020C2CH033 | ● F020C3CH033 | ● F020C4CH033 |

¹Standard - Schema elettrico n.1 page 436 / Wiring diagram n.1 page 436

- | | | |
|---------------|---------------|---------------|
| 2700K | 3000K | 4000K |
| ○ F020A2GH001 | ○ F020A3GH001 | ○ F020A4GH001 |
| ● F020A2GH006 | ● F020A3GH006 | ● F020A4GH006 |
| ● F020A2GH012 | ● F020A3GH012 | ● F020A4GH012 |
| ● F020A2GH018 | ● F020A3GH018 | ● F020A4GH018 |
| ● F020A2GH030 | ● F020A3GH030 | ● F020A4GH030 |
| ● F020A2GH033 | ● F020A3GH033 | ● F020A4GH033 |

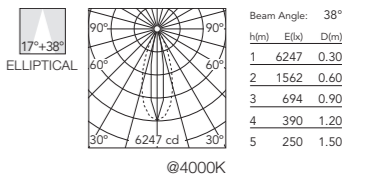

²Quick Install I H2O Stop Fast Connect - Schema elettrico n.2 page 436 / Wiring diagram n.2 page 436

- | | | |
|---------------|---------------|---------------|
| 2700K | 3000K | 4000K |
| ○ F020B2GH001 | ○ F020B3GH001 | ○ F020B4GH001 |
| ● F020B2GH006 | ● F020B3GH006 | ● F020B4GH006 |
| ● F020B2GH012 | ● F020B3GH012 | ● F020B4GH012 |
| ● F020B2GH018 | ● F020B3GH018 | ● F020B4GH018 |
| ● F020B2GH030 | ● F020B3GH030 | ● F020B4GH030 |
| ● F020B2GH033 | ● F020B3GH033 | ● F020B4GH033 |

³Continuous Line I/O H2O Stop Fast Connect - Schema elettrico n.3 page 436 / Wiring diagram n.3 page 436

- | | | |
|---------------|---------------|---------------|
| 2700K | 3000K | 4000K |
| ○ F020C2GH001 | ○ F020C3GH001 | ○ F020C4GH001 |
| ● F020C2GH006 | ● F020C3GH006 | ● F020C4GH006 |
| ● F020C2GH012 | ● F020C3GH012 | ● F020C4GH012 |
| ● F020C2GH018 | ● F020C3GH018 | ● F020C4GH018 |
| ● F020C2GH030 | ● F020C3GH030 | ● F020C4GH030 |
| ● F020C2GH033 | ● F020C3GH033 | ● F020C4GH033 |

¹Standard - Schema elettrico n.1 page 436 / Wiring diagram n.1 page 436

- | | | |
|---------------|---------------|---------------|
| 2700K | 3000K | 4000K |
| ○ F020A2LH001 | ○ F020A3LH001 | ○ F020A4LH001 |
| ● F020A2LH006 | ● F020A3LH006 | ● F020A4LH006 |
| ● F020A2LH012 | ● F020A3LH012 | ● F020A4LH012 |
| ● F020A2LH018 | ● F020A3LH018 | ● F020A4LH018 |
| ● F020A2LH030 | ● F020A3LH030 | ● F020A4LH030 |
| ● F020A2LH033 | ● F020A3LH033 | ● F020A4LH033 |

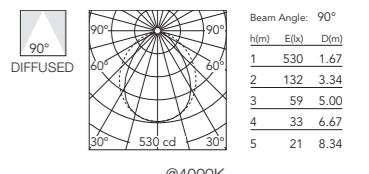

²Quick Install I H2O Stop Fast Connect - Schema elettrico n.2 page 436 / Wiring diagram n.2 page 436

- | | | |
|---------------|---------------|---------------|
| 2700K | 3000K | 4000K |
| ○ F020B2LH001 | ○ F020B3LH001 | ○ F020B4LH001 |
| ● F020B2LH006 | ● F020B3LH006 | ● F020B4LH006 |
| ● F020B2LH012 | ● F020B3LH012 | ● F020B4LH012 |
| ● F020B2LH018 | ● F020B3LH018 | ● F020B4LH018 |
| ● F020B2LH030 | ● F020B3LH030 | ● F020B4LH030 |
| ● F020B2LH033 | ● F020B3LH033 | ● F020B4LH033 |

³Continuous Line I/O H2O Stop Fast Connect - Schema elettrico n.3 page 436 / Wiring diagram n.3 page 436

- | | | |
|---------------|---------------|---------------|
| 2700K | 3000K | 4000K |
| ○ F020C2LH001 | ○ F020C3LH001 | ○ F020C4LH001 |
| ● F020C2LH006 | ● F020C3LH006 | ● F020C4LH006 |
| ● F020C2LH012 | ● F020C3LH012 | ● F020C4LH012 |
| ● F020C2LH018 | ● F020C3LH018 | ● F020C4LH018 |
| ● F020C2LH030 | ● F020C3LH030 | ● F020C4LH030 |
| ● F020C2LH033 | ● F020C3LH033 | ● F020C4LH033 |

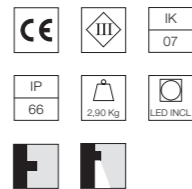
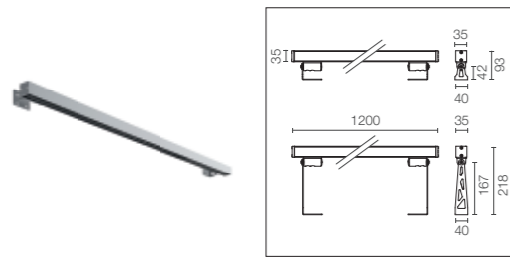

Alimentazione elettrica remota 48V e staffe di installazione da ordinare separatamente. Vetro trasparente extra chiaro, esclusa versione DIFFUSED con vetro sabbiato. Apparecchi dimmerabili PWM. A richiesta versione SMART (potenza 14W - flusso -50% lm).

48V remote power supply and installation brackets to be ordered separately. Extra clear transparent glass, excluding the DIFFUSE version with sandblasted glass. Dimmable PWM luminaires. SMART version available upon request (power 14W - flux -50% lm).

Power Led: 23W - 2782 lm ≠ *FIXT 2069 lm - 2700K/CRI 80 - 48V /23W - 2881 lm ≠ *FIXT 2142 lm - 3000K/CRI 80 - 48V / 23W - 2981 lm ≠ *FIXT 2216 lm - 4000K/CRI 80 - 48V
*FIXT lm = Medium Optic

¹Standard - Schema elettrico n.1 page 436 / Wiring diagram n.1 page 436

- | | | |
|---------------|---------------|---------------|
| 2700K | 3000K | 4000K |
| ○ F020A24H001 | ○ F020A34H001 | ○ F020A44H001 |
| ● F020A24H006 | ● F020A34H006 | ● F020A44H006 |
| ● F020A24H012 | ● F020A34H012 | ● F020A44H012 |
| ● F020A24H018 | ● F020A34H018 | ● F020A44H018 |
| ● F020A24H030 | ● F020A34H030 | ● F020A44H030 |
| ● F020A24H033 | ● F020A34H033 | ● F020A44H033 |

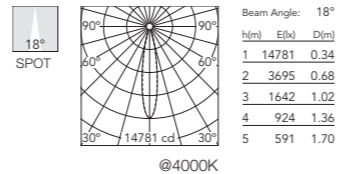

²Quick Install I H2O Stop Fast Connect - Schema elettrico n.2 page 436 / Wiring diagram n.2 page 436

- | | | |
|---------------|---------------|---------------|
| 2700K | 3000K | 4000K |
| ○ F020B24H001 | ○ F020B34H001 | ○ F020B44H001 |
| ● F020B24H006 | ● F020B34H006 | ● F020B44H006 |
| ● F020B24H012 | ● F020B34H012 | ● F020B44H012 |
| ● F020B24H018 | ● F020B34H018 | ● F020B44H018 |
| ● F020B24H030 | ● F020B34H030 | ● F020B44H030 |
| ● F020B24H033 | ● F020B34H033 | ● F020B44H033 |

³Continuous Line I/O H2O Stop Fast Connect - Schema elettrico n.3 page 436 / Wiring diagram n.3 page 436

- | | | |
|---------------|---------------|---------------|
| 2700K | 3000K | 4000K |
| ○ F020C24H001 | ○ F020C34H001 | ○ F020C44H001 |
| ● F020C24H006 | ● F020C34H006 | ● F020C44H006 |
| ● F020C24H012 | ● F020C34H012 | ● F020C44H012 |
| ● F020C24H018 | ● F020C34H018 | ● F020C44H018 |
| ● F020C24H030 | ● F020C34H030 | ● F020C44H030 |
| ● F020C24H033 | ● F020C34H033 | ● F020C44H033 |

¹Standard - Schema elettrico n.1 page 436 / Wiring diagram n.1 page 436

- | | | |
|---------------|---------------|---------------|
| 2700K | 3000K | 4000K |
| ○ F020A28H001 | ○ F020A38H001 | ○ F020A48H001 |
| ● F020A28H006 | ● F020A38H006 | ● F020A48H006 |
| ● F020A28H012 | ● F020A38H012 | ● F020A48H012 |
| ● F020A28H018 | ● F020A38H018 | ● F020A48H018 |
| ● F020A28H030 | ● F020A38H030 | ● F020A48H030 |
| ● F020A28H033 | ● F020A38H033 | ● F020A48H033 |

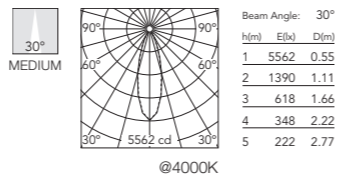

²Quick Install I H2O Stop Fast Connect - Schema elettrico n.2 page 436 / Wiring diagram n.2 page 436

- | | | |
|---------------|---------------|---------------|
| 2700K | 3000K | 4000K |
| ○ F020B28H001 | ○ F020B38H001 | ○ F020B48H001 |
| ● F020B28H006 | ● F020B38H006 | ● F020B48H006 |
| ● F020B28H012 | ● F020B38H012 | ● F020B48H012 |
| ● F020B28H018 | ● F020B38H018 | ● F020B48H018 |
| ● F020B28H030 | ● F020B38H030 | ● F020B48H030 |
| ● F020B28H033 | ● F020B38H033 | ● F020B48H033 |

³Continuous Line I/O H2O Stop Fast Connect - Schema elettrico n.3 page 436 / Wiring diagram n.3 page 436

- | | | |
|---------------|---------------|---------------|
| 2700K | 3000K | 4000K |
| ○ F020C28H001 | ○ F020C38H001 | ○ F020C48H001 |
| ● F020C28H006 | ● F020C38H006 | ● F020C48H006 |
| ● F020C28H012 | ● F020C38H012 | ● F020C48H012 |
| ● F020C28H018 | ● F020C38H018 | ● F020C48H018 |
| ● F020C28H030 | ● F020C38H030 | ● F020C48H030 |
| ● F020C28H033 | ● F020C38H033 | ● F020C48H033 |

¹Standard Version: spezzone di cavo in uscita 1000 mm (accessori per collegamento da ordinare) / 1000 mm length prewired cable (connecting accessory to be separately ordered).

²Quick Install In H2O Stop Version: connettore H2O Stop Plug&Play preinstallato per connessione rapida (accessori per collegamento da ordinare) / Prewired H2O Stop Plug&Play connector for an easy/rapid connection (connecting accessory to be ordered separately).

³Continuous Line In/Out H2O Stop Version: connettori H2O Stop Plug&Play preinstallati per connessione in linea (accessori per collegamento da ordinare) / Prewired H2O Stop Plug&Play connectors for an easy in line connection (connecting accessory to be ordered separately).

¹Standard - Schema elettrico n.1 page 436 / Wiring diagram n.1 page 436

- | | | |
|---------------|---------------|---------------|
| 2700K | 3000K | 4000K |
| ○ F020A2DH001 | ○ F020A3DH001 | ○ F020A4DH001 |
| ● F020A2DH006 | ● F020A3DH006 | ● F020A4DH006 |
| ● F020A2DH012 | ● F020A3DH012 | ● F020A4DH012 |
| ● F020A2DH018 | ● F020A3DH018 | ● F020A4DH018 |
| ● F020A2DH030 | ● F020A3DH030 | ● F020A4DH030 |
| ● F020A2DH033 | ● F020A3DH033 | ● F020A4DH033 |

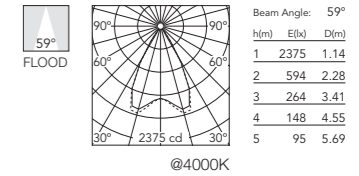

²Quick Install I H2O Stop Fast Connect - Schema elettrico n.2 page 436 / Wiring diagram n.2 page 436

- | | | |
|---------------|---------------|---------------|
| 2700K | 3000K | 4000K |
| ○ F020B2DH001 | ○ F020B3DH001 | ○ F020B4DH001 |
| ● F020B2DH006 | ● F020B3DH006 | ● F020B4DH006 |
| ● F020B2DH012 | ● F020B3DH012 | ● F020B4DH012 |
| ● F020B2DH018 | ● F020B3DH018 | ● F020B4DH018 |
| ● F020B2DH030 | ● F020B3DH030 | ● F020B4DH030 |
| ● F020B2DH033 | ● F020B3DH033 | ● F020B4DH033 |

³Continuous Line I/O H2O Stop Fast Connect - Schema elettrico n.3 page 436 / Wiring diagram n.3 page 436

- | | | |
|---------------|---------------|---------------|
| 2700K | 3000K | 4000K |
| ○ F020C2DH001 | ○ F020C3DH001 | ○ F020C4DH001 |
| ● F020C2DH006 | ● F020C3DH006 | ● F020C4DH006 |
| ● F020C2DH012 | ● F020C3DH012 | ● F020C4DH012 |
| ● F020C2DH018 | ● F020C3DH018 | ● F020C4DH018 |
| ● F020C2DH030 | ● F020C3DH030 | ● F020C4DH030 |
| ● F020C2DH033 | ● F020C3DH033 | ● F020C4DH033 |

¹Standard - Schema elettrico n.1 page 436 / Wiring diagram n.1 page 436

- | | | |
|---------------|---------------|---------------|
| 2700K | 3000K | 4000K |
| ○ F020A2HH001 | ○ F020A3HH001 | ○ F020A4HH001 |
| ● F020A2HH006 | ● F020A3HH006 | ● F020A4HH006 |
| ● F020A2HH012 | ● F020A3HH012 | ● F020A4HH012 |
| ● F020A2HH018 | ● F020A3HH018 | ● F020A4HH018 |
| ● F020A2HH030 | ● F020A3HH030 | ● F020A4HH030 |
| ● F020A2HH033 | ● F020A3HH033 | ● F020A4HH033 |

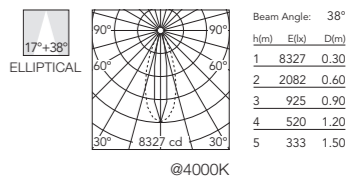

²Quick Install I H2O Stop Fast Connect - Schema elettrico n.2 page 436 / Wiring diagram n.2 page 436

- | | | |
|---------------|---------------|---------------|
| 2700K | 3000K | 4000K |
| ○ F020B2HH001 | ○ F020B3HH001 | ○ F020B4HH001 |
| ● F020B2HH006 | ● F020B3HH006 | ● F020B4HH006 |
| ● F020B2HH012 | ● F020B3HH012 | ● F020B4HH012 |
| ● F020B2HH018 | ● F020B3HH018 | ● F020B4HH018 |
| ● F020B2HH030 | ● F020B3HH030 | ● F020B4HH030 |
| ● F020B2HH033 | ● F020B3HH033 | ● F020B4HH033 |

³Continuous Line I/O H2O Stop Fast Connect - Schema elettrico n.3 page 436 / Wiring diagram n.3 page 436

- | | | |
|---------------|---------------|---------------|
| 2700K | 3000K | 4000K |
| ○ F020C2HH001 | ○ F020C3HH001 | ○ F020C4HH001 |
| ● F020C2HH006 | ● F020C3HH006 | ● F020C4HH006 |
| ● F020C2HH012 | ● F020C3HH012 | ● F020C4HH012 |
| ● F020C2HH018 | ● F020C3HH018 | ● F020C4HH018 |
| ● F020C2HH030 | ● F020C3HH030 | ● F020C4HH030 |
| ● F020C2HH033 | ● F020C3HH033 | ● F020C4HH033 |

¹Standard - Schema elettrico n.1 page 436 / Wiring diagram n.1 page 436

- | | | |
|---------------|---------------|---------------|
| 2700K | 3000K | 4000K |
| ○ F020A2MH001 | ○ F020A3MH001 | ○ F020A4MH001 |
| ● F020A2MH006 | ● F020A3MH006 | ● F020A4MH006 |
| ● F020A2MH012 | ● F020A3MH012 | ● F020A4MH012 |
| ● F020A2MH018 | ● F020A3MH018 | ● F020A4MH018 |
| ● F020A2MH030 | ● F020A3MH030 | ● F020A4MH030 |
| ● F020A2MH033 | ● F020A3MH033 | ● F020A4MH033 |

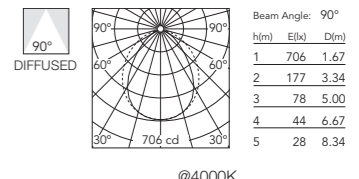

²Quick Install I H2O Stop Fast Connect - Schema elettrico n.2 page 436 / Wiring diagram n.2 page 436

- | | | |
|---------------|---------------|---------------|
| 2700K | 3000K | 4000K |
| ○ F020B2MH001 | ○ F020B3MH001 | ○ F020B4MH001 |
| ● F020B2MH006 | ● F020B3MH006 | ● F020B4MH006 |
| ● F020B2MH012 | ● F020B3MH012 | ● F020B4MH012 |
| ● F020B2MH018 | ● F020B3MH018 | ● F020B4MH018 |
| ● F020B2MH030 | ● F020B3MH030 | ● F020B4MH030 |
| ● F020B2MH033 | ● F020B3MH033 | ● F020B4MH033 |

³Continuous Line I/O H2O Stop Fast Connect - Schema elettrico n.3 page 436 / Wiring diagram n.3 page 436

- | | | |
|---------------|---------------|---------------|
| 2700K | 3000K | 4000K |
| ○ F020C2MH001 | ○ F020C3MH001 | ○ F020C4MH001 |
| ● F020C2MH006 | ● F020C3MH006 | ● F020C4MH006 |
| ● F020C2MH012 | ● F020C3MH012 | ● F020C4MH012 |
| ● F020C2MH018 | ● F020C3MH018 | ● F020C4MH018 |
| ● F020C2MH030 | ● F020C3MH030 | ● F020C4MH030 |
| ● F020C2MH033 | ● F020C3MH033 | ● F020C4MH033 |

Outgraze 35 Easy L 300

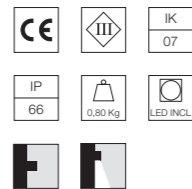
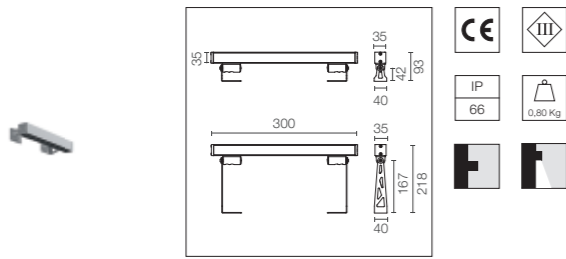

Alimentazione elettrica remota 24V e staffe di installazione da ordinare separatamente. Apparecchi dimmerabili PWM. Vetro sabbiato.

24V remote power supply and installation brackets to be ordered separately. Dimmable PWM luminaires. Sandblasted glass.

Mid-power Led: 4,5W - 454 lm ≠ FIXT 190 lm - 2700K/CRI 80 - 24V / 4,5W - 494 lm ≠ FIXT 207 lm - 3000K/CRI 80 - 24V / 4,5W - 533 lm ≠ FIXT 223 lm - 4000K/CRI 80 - 24V

¹**Standard** - Schema elettrico n.1 page 436 / Wiring diagram n.1 page 436

- | | | |
|---------------|---------------|---------------|
| 2700K | 3000K | 4000K |
| ○ F020G2JH001 | ○ F020G3JH001 | ○ F020G4JH001 |
| ● F020G2JH006 | ● F020G3JH006 | ● F020G4JH006 |
| ● F020G2JH012 | ● F020G3JH012 | ● F020G4JH012 |
| ● F020G2JH018 | ● F020G3JH018 | ● F020G4JH018 |
| ● F020G2JH030 | ● F020G3JH030 | ● F020G4JH030 |
| ● F020G2JH033 | ● F020G3JH033 | ● F020G4JH033 |

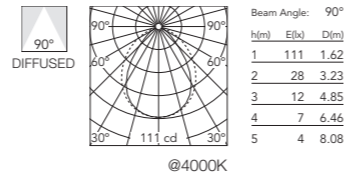

²**Quick Install I H2O Stop Fast Connect** - Schema elettrico n.2 page 436 / Wiring diagram n.2 page 436

- | | | |
|---------------|---------------|---------------|
| 2700K | 3000K | 4000K |
| ○ F020H2JH001 | ○ F020H3JH001 | ○ F020H4JH001 |
| ● F020H2JH006 | ● F020H3JH006 | ● F020H4JH006 |
| ● F020H2JH012 | ● F020H3JH012 | ● F020H4JH012 |
| ● F020H2JH018 | ● F020H3JH018 | ● F020H4JH018 |
| ● F020H2JH030 | ● F020H3JH030 | ● F020H4JH030 |
| ● F020H2JH033 | ● F020H3JH033 | ● F020H4JH033 |

Outgraze 35 Easy L 300 - Tunable White 2700K÷5700K

Mid-power Led: 4,5W - 227÷286 lm ≠ FIXT 95÷120 lm - 2700K÷5700K/CRI 80 - 2CH x 24V

¹**Tunable White Standard** - Schema elettrico n.4 page 437 / Wiring diagram n.4 page 437

- 2700K÷5700K**
- F020GTJH001
 - F020GTJH006
 - F020GTJH012
 - F020GTJH018
 - F020GTJH030
 - F020GTJH033



²**Tunable White Quick Install I H2O Stop Fast Connect** - Schema elettrico n.5 page 437 / Wiring diagram n.5 page 437

- 2700K÷5700K**
- F020HTJH001
 - F020HTJH006
 - F020HTJH012
 - F020HTJH018
 - F020HTJH030
 - F020HTJH033

Photometric data on request.

¹Standard Version: spezzone di cavo in uscita 1000 mm (accessori per collegamento da ordinare) / 1000 mm length prewired cable (connecting accessory to be separately ordered).

²Quick Install In H2O Stop Version: connettore H2O Stop Plug&Play preinstallato per connessione rapida (accessori per collegamento da ordinare) / Prewired H2O Stop Plug&Play connector for an easy/rapid connection (connecting accessory to be ordered separately).

Outgraze 35 Easy L 600

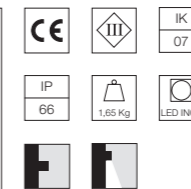
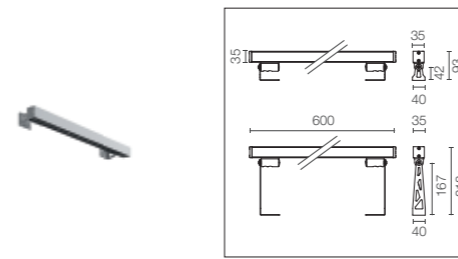

Alimentazione elettrica remota 24V e staffe di installazione da ordinare separatamente. Apparecchi dimmerabili PWM. Vetro sabbiato.

24V remote power supply and installation brackets to be ordered separately. Dimmable PWM luminaires. Sandblasted glass.

Mid-power Led: 9W - 909 lm ≠ FIXT 381 lm - 2700K/CRI 80 - 24V / 9W - 988 lm ≠ FIXT 414 lm - 3000K/CRI 80 - 24V / 9W - 1067 lm ≠ FIXT 447 lm - 4000K/CRI 80 - 24V

¹**Standard** - Schema elettrico n.1 page 436 / Wiring diagram n.1 page 436

- | | | |
|---------------|---------------|---------------|
| 2700K | 3000K | 4000K |
| ○ F020G2KH001 | ○ F020G3KH001 | ○ F020G4KH001 |
| ● F020G2KH006 | ● F020G3KH006 | ● F020G4KH006 |
| ● F020G2KH012 | ● F020G3KH012 | ● F020G4KH012 |
| ● F020G2KH018 | ● F020G3KH018 | ● F020G4KH018 |
| ● F020G2KH030 | ● F020G3KH030 | ● F020G4KH030 |
| ● F020G2KH033 | ● F020G3KH033 | ● F020G4KH033 |

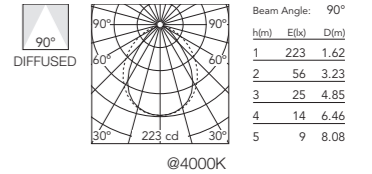

²**Quick Install I H2O Stop Fast Connect** - Schema elettrico n.2 page 436 / Wiring diagram n.2 page 436

- | | | |
|---------------|---------------|---------------|
| 2700K | 3000K | 4000K |
| ○ F020H2KH001 | ○ F020H3KH001 | ○ F020H4KH001 |
| ● F020H2KH006 | ● F020H3KH006 | ● F020H4KH006 |
| ● F020H2KH012 | ● F020H3KH012 | ● F020H4KH012 |
| ● F020H2KH018 | ● F020H3KH018 | ● F020H4KH018 |
| ● F020H2KH030 | ● F020H3KH030 | ● F020H4KH030 |
| ● F020H2KH033 | ● F020H3KH033 | ● F020H4KH033 |

³**Continuous Line I/O H2O Stop Fast Connect** - Schema elettrico n.3 page 436 / Wiring diagram n.3 page 436

- | | | |
|---------------|---------------|---------------|
| 2700K | 3000K | 4000K |
| ○ F020J2KH001 | ○ F020J3KH001 | ○ F020J4KH001 |
| ● F020J2KH006 | ● F020J3KH006 | ● F020J4KH006 |
| ● F020J2KH012 | ● F020J3KH012 | ● F020J4KH012 |
| ● F020J2KH018 | ● F020J3KH018 | ● F020J4KH018 |
| ● F020J2KH030 | ● F020J3KH030 | ● F020J4KH030 |
| ● F020J2KH033 | ● F020J3KH033 | ● F020J4KH033 |

Outgraze 35 Easy L 600 - Tunable White 2700K÷5700K

Mid-power Led: 9W - 454÷573 lm ≠ FIXT 190÷240 lm - 2700K÷5700K/CRI 80 - 2CH x 24V

¹**Tunable White Standard** - Schema elettrico n.4 page 437 / Wiring diagram n.4 page 437

- 2700K÷5700K**
- F020GTKH001
 - F020GTKH006
 - F020GTKH012
 - F020GTKH018
 - F020GTKH030
 - F020GTKH033



²**Tunable White Quick Install I H2O Stop Fast Connect** - Schema elettrico n.5 page 437 / Wiring diagram n.5 page 437

- 2700K÷5700K**
- F020HTKH001
 - F020HTKH006
 - F020HTKH012
 - F020HTKH018
 - F020HTKH030
 - F020HTKH033

³**Tunable White Continuous Line I/O H2O Stop Fast Connect** - Schema elettrico n.6 page 437 / Wiring diagram n.6 page 437

- 2700K÷5700K**
- F020JTKH001
 - F020JTKH006
 - F020JTKH012
 - F020JTKH018
 - F020JTKH030
 - F020JTKH033

Photometric data on request.

¹Standard Version: spezzone di cavo in uscita 1000 mm (accessori per collegamento da ordinare) / 1000 mm length prewired cable (connecting accessory to be separately ordered).

²Quick Install In H2O Stop Version: connettore H2O Stop Plug&Play preinstallato per connessione rapida (accessori per collegamento da ordinare) / Prewired H2O Stop Plug&Play connector for an easy/rapid connection (connecting accessory to be ordered separately).

³Continuous Line In/Out H2O Stop Version: connettori H2O Stop Plug&Play preinstallati per connessione in linea (accessori per collegamento da ordinare) / Prewired H2O Stop Plug&Play connectors for an easy in line connection (connecting accessory to be ordered separately).

Outgraze 35 Easy L 900

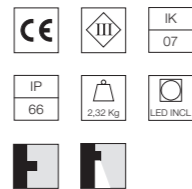
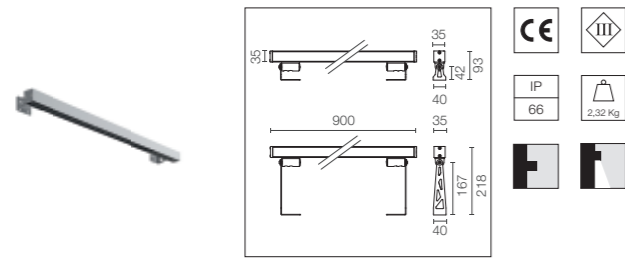

Alimentazione elettrica remota 24V e staffe di installazione da ordinare separatamente. Apparecchi dimmerabili PWM. Vetro sabbato.

24V remote power supply and installation brackets to be ordered separately. Dimmable PWM luminaires. Sandblasted glass.

Mid-power Led: 13W - 1363 lm ≠ FIXT 571 lm - 2700K/CRI 80 - 24V / 13W - 1481 lm ≠ FIXT 621 lm - 3000K/CRI 80 - 24V / 13W - 1600 lm ≠ FIXT 670 lm - 4000K/CRI 80 - 24V

¹**Standard** - Schema elettrico n.1 page 436 / Wiring diagram n.1 page 436

- | | | |
|---------------|---------------|---------------|
| 2700K | 3000K | 4000K |
| ○ F020G2LH001 | ○ F020G3LH001 | ○ F020G4LH001 |
| ● F020G2LH006 | ● F020G3LH006 | ● F020G4LH006 |
| ● F020G2LH012 | ● F020G3LH012 | ● F020G4LH012 |
| ● F020G2LH018 | ● F020G3LH018 | ● F020G4LH018 |
| ● F020G2LH030 | ● F020G3LH030 | ● F020G4LH030 |
| ● F020G2LH033 | ● F020G3LH033 | ● F020G4LH033 |

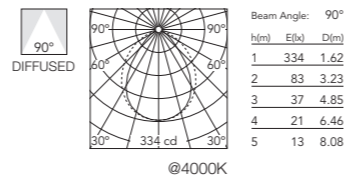

²**Quick Install I H2O Stop Fast Connect** - Schema elettrico n.2 page 436 / Wiring diagram n.2 page 436

- | | | |
|---------------|---------------|---------------|
| 2700K | 3000K | 4000K |
| ○ F020H2LH001 | ○ F020H3LH001 | ○ F020H4LH001 |
| ● F020H2LH006 | ● F020H3LH006 | ● F020H4LH006 |
| ● F020H2LH012 | ● F020H3LH012 | ● F020H4LH012 |
| ● F020H2LH018 | ● F020H3LH018 | ● F020H4LH018 |
| ● F020H2LH030 | ● F020H3LH030 | ● F020H4LH030 |
| ● F020H2LH033 | ● F020H3LH033 | ● F020H4LH033 |

³**Continuous Line I/O H2O Stop Fast Connect** - Schema elettrico n.3 page 436 / Wiring diagram n.3 page 436

- | | | |
|---------------|---------------|---------------|
| 2700K | 3000K | 4000K |
| ○ F020J2LH001 | ○ F020J3LH001 | ○ F020J4LH001 |
| ● F020J2LH006 | ● F020J3LH006 | ● F020J4LH006 |
| ● F020J2LH012 | ● F020J3LH012 | ● F020J4LH012 |
| ● F020J2LH018 | ● F020J3LH018 | ● F020J4LH018 |
| ● F020J2LH030 | ● F020J3LH030 | ● F020J4LH030 |
| ● F020J2LH033 | ● F020J3LH033 | ● F020J4LH033 |

Outgraze 35 Easy L 900 - Tunable White 2700K÷5700K

Mid-power Led: 13W - 681÷859 lm ≠ FIXT 285÷360 lm - 2700K÷5700K/CRI 80 - 2CH x 24V

¹**Tunable White Standard** - Schema elettrico n.4 page 437 / Wiring diagram n.4 page 437

- 2700K÷5700K**
- F020GTLH001
 - F020GTLH006
 - F020GTLH012
 - F020GTLH018
 - F020GTLH030
 - F020GTLH033



²**Tunable White Quick Install I H2O Stop Fast Connect** - Schema elettrico n.5 page 437 / Wiring diagram n.5 page 437

- 2700K÷5700K**
- F020HTLH001
 - F020HTLH006
 - F020HTLH012
 - F020HTLH018
 - F020HTLH030
 - F020HTLH033

³**Tunable White Continuous Line I/O H2O Stop Fast Connect** - Schema elettrico n.6 page 437 / Wiring diagram n.6 page 437

- 2700K÷5700K**
- F020JTLH001
 - F020JTLH006
 - F020JTLH012
 - F020JTLH018
 - F020JTLH030
 - F020JTLH033

Photometric data on request.

¹Standard Version: spezzone di cavo in uscita 1000 mm (accessori per collegamento da ordinare) / 1000 mm length prewired cable (connecting accessory to be separately ordered).

²Quick Install In H2O Stop Version: connettore H2O Stop Plug&Play preinstallato per connessione rapida (accessori per collegamento da ordinare) / Prewired H2O Stop Plug&Play connector for an easy/rapid connection (connecting accessory to be ordered separately).

³Continuous Line In/Out H2O Stop Version: connettori H2O Stop Plug&Play preinstallati per connessione in linea (accessori per collegamento da ordinare) / Prewired H2O Stop Plug&Play connectors for an easy in line connection (connecting accessory to be ordered separately).

Outgraze 35 Easy L 1200

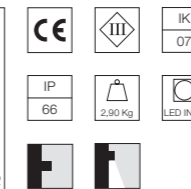
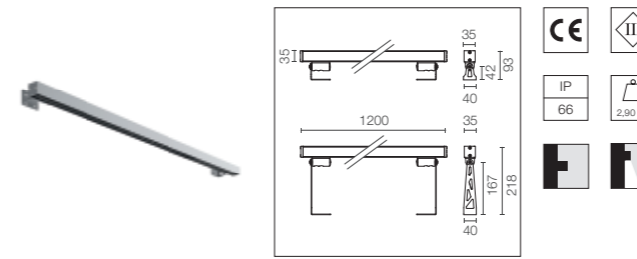

Alimentazione elettrica remota 24V e staffe di installazione da ordinare separatamente. Apparecchi dimmerabili PWM. Vetro sabbato.

24V remote power supply and installation brackets to be ordered separately. Dimmable PWM luminaires. Sandblasted glass.

Mid-power Led: 17,5W - 1817 lm ≠ FIXT 761 lm - 2700K/CRI 80 - 24V / 17,5W - 1975 lm ≠ FIXT 827 lm - 3000K/CRI 80 - 24V / 17,5W - 2133 lm ≠ FIXT 894 lm - 4000K/CRI 80 - 24V

¹**Standard** - Schema elettrico n.1 page 436 / Wiring diagram n.1 page 436

- | | | |
|---------------|---------------|---------------|
| 2700K | 3000K | 4000K |
| ○ F020G2MH001 | ○ F020G3MH001 | ○ F020G4MH001 |
| ● F020G2MH006 | ● F020G3MH006 | ● F020G4MH006 |
| ● F020G2MH012 | ● F020G3MH012 | ● F020G4MH012 |
| ● F020G2MH018 | ● F020G3MH018 | ● F020G4MH018 |
| ● F020G2MH030 | ● F020G3MH030 | ● F020G4MH030 |
| ● F020G2MH033 | ● F020G3MH033 | ● F020G4MH033 |

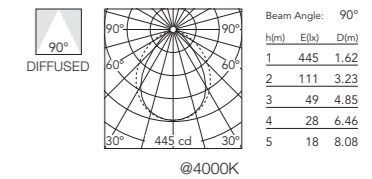

²**Quick Install I H2O Stop Fast Connect** - Schema elettrico n.2 page 436 / Wiring diagram n.2 page 436

- | | | |
|---------------|---------------|---------------|
| 2700K | 3000K | 4000K |
| ○ F020H2MH001 | ○ F020H3MH001 | ○ F020H4MH001 |
| ● F020H2MH006 | ● F020H3MH006 | ● F020H4MH006 |
| ● F020H2MH012 | ● F020H3MH012 | ● F020H4MH012 |
| ● F020H2MH018 | ● F020H3MH018 | ● F020H4MH018 |
| ● F020H2MH030 | ● F020H3MH030 | ● F020H4MH030 |
| ● F020H2MH033 | ● F020H3MH033 | ● F020H4MH033 |

³**Continuous Line I/O H2O Stop Fast Connect** - Schema elettrico n.3 page 436 / Wiring diagram n.3 page 436

- | | | |
|---------------|---------------|---------------|
| 2700K | 3000K | 4000K |
| ○ F020J2MH001 | ○ F020J3MH001 | ○ F020J4MH001 |
| ● F020J2MH006 | ● F020J3MH006 | ● F020J4MH006 |
| ● F020J2MH012 | ● F020J3MH012 | ● F020J4MH012 |
| ● F020J2MH018 | ● F020J3MH018 | ● F020J4MH018 |
| ● F020J2MH030 | ● F020J3MH030 | ● F020J4MH030 |
| ● F020J2MH033 | ● F020J3MH033 | ● F020J4MH033 |

Outgraze 35 Easy L 1200 - Tunable White 2700K÷5700K

Mid-power Led: 17,5W - 909÷1146 lm ≠ FIXT 381÷480 lm - 2700K÷5700K/CRI 80 - 2CH x 24V

¹**Tunable White Standard** - Schema elettrico n.4 page 437 / Wiring diagram n.4 page 437

- 2700K÷5700K**
- F020GTMH001
 - F020GTMH006
 - F020GTMH012
 - F020GTMH018
 - F020GTMH030
 - F020GTMH033



²**Tunable White Quick Install I H2O Stop Fast Connect** - Schema elettrico n.5 page 437 / Wiring diagram n.5 page 437

- 2700K÷5700K**
- F020HTMH001
 - F020HTMH006
 - F020HTMH012
 - F020HTMH018
 - F020HTMH030
 - F020HTMH033

³**Tunable White Continuous Line I/O H2O Stop Fast Connect** - Schema elettrico n.6 page 437 / Wiring diagram n.6 page 437

- 2700K÷5700K**
- F020JTMH001
 - F020JTMH006
 - F020JTMH012
 - F020JTMH018
 - F020JTMH030
 - F020JTMH033

Photometric data on request.





¹Standard Version: spezzone di cavo in uscita 1000 mm (accessori per collegamento da ordinare) / 1000 mm length prewired cable (connecting accessory to be separately ordered).

²Quick Install In H2O Stop Version: connettore H2O Stop Plug&Play preinstallato per connessione rapida (accessori per collegamento da ordinare) / Prewired H2O Stop Plug&Play connector for an easy/rapid connection (connecting accessory to be ordered separately).

³Continuous Line In/Out H2O Stop Version: connettori H2O Stop Plug&Play preinstallati per connessione in linea (accessori per collegamento da ordinare) / Prewired H2O Stop Plug&Play connectors for an easy in line connection (connecting accessory to be ordered separately).





Outgraze 35

Accessori per tutti le versioni / Accessories for all versions

Coppia staffe corte L 80mm.	One pair of short brackets L 80 mm.	<ul style="list-style-type: none"> ○ F1203001 ● F1203006 ● F1203012 ● F1203018 ● F1203030 ● F1203033 		
Coppia staffe lunghe L 200mm.	One pair of long brackets L 200 mm.	<ul style="list-style-type: none"> ○ F1204001 ● F1204006 ● F1204012 ● F1204018 ● F1204030 ● F1204033 		
Sistema di giunzione IP68 H2O Stop anti-condensa a 2 vie 4 poli. (Ø5,5÷12mm cavo).	2 way terminal block 4 poles IP68 H2O Stop. (ø5,5÷12mm cable).	F990C00A000		
Sistema di giunzione IP68 H2O Stop anti-condensa a 3/4 vie 4 poli. (Ø5,5÷12mm cavo).	3/4 way terminal block 4 poles IP68 H2O Stop. (ø5,5÷12mm cable).	F990C010000		

Outgraze 35

Accessori per versioni Quick Install I H2O Stop e Continuous Line I/O H2O Stop / Accessories for Quick Install I H2O Stop and Continuous Line I/O H2O Stop versions

Connettore 4 poli plug&play.	Plug&play connector 4 poles.	F021Z010000		
Doppio connettore 4 poli plug&play + cavo L 600 mm.	Double plug&play connector 4 poles + cable 600 mm lenght.	F021Z090000		
Connettore 4 poli plug&play + cavo L 5000 mm.	Plug&play connector 4 poles + cable 5000 mm lenght.	F021Z100000		
Tappo per connettore a pannello (sul prodotto) 4-5 poli.	Cap for panel (on the fixtures) plug connector 4-5 poles.	F021Z070000		

Outgraze 35

Interfaccia PWM (Dimmerabilita') per versione 48V / PWM interface (Dimming) for 48V version Alimentatore per interfaccia 48V/240V non incluso, da ordinare / Power supply 48V/240V for interface not included, to be ordered (cod.RF25753 or cod.RF25746)

Interfaccia di controllo DALI PWM 48Vdc 120W IP20. Alimentatore non incluso.	DALI PWM control interface 48Vdc 120W IP20. Power supply not included.	F990B08A000		
Interfaccia di controllo 1-10V PWM 48Vdc 120W IP20. Alimentatore non incluso.	1-10V PWM control interface 48Vdc 120W IP20. Power supply not included.	F990B15A000		

Outgraze 35

Alimentatore per versione 48V / Power supply for 48V version

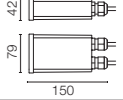

Alimentatore 48V 60W / 110-240V IP67 Classe II selv eq.	Power supply 48V 60W / 110-240V IP67 Class II selv eq.	RF25753		
Alimentatore 48V 240W / 110-240V singolo output DIN RAIL.	Power supply 48V 240W / 110-240V single output DIN RAIL.	RF25746		

* Numero massimo di apparecchi per alimentatore / Maximum number of luminaires per power supply.

Numero massimo di apparecchi per alimentatore (Vin220÷240). Dati indicativi da verificare con le specifiche condizioni di installazione.	Maximum number of luminaires per power supply. (220÷240 V). These data must be checked taking into account the specific installation conditions.	Acc. RF25753	Acc. RF25746	L 300	L 600	L 900	L 1200
		8	32	8	4	2	2
				32	16	10	8

Outgraze 35

Interfaccia PWM (Dimmerabilita') per versione 24V / PWM interface (Dimming) for 24V version Alimentatore per interfaccia 24V/240V non incluso, da ordinare / Power supply 24V/240V for interface not included, to be ordered (cod.RF25755, cod.RF25749 or cod.RF25756)

Interfaccia di controllo DALI PWM 24Vdc 120W IP20. Alimentatore non incluso.	DALI PWM control interface 24Vdc 120W IP20. Power supply not included.	F990B07A000		
Interfaccia di controllo 1-10V PWM 24Vdc 120W IP20. Alimentatore non incluso.	1-10V PWM control interface 24Vdc 120W IP20. Power supply not included.	F990B14A000		



Outgraze 35

Interfaccia PWM per versione 24V Tunable White / PWM interface for 24V Tunable White version Alimentatore per interfaccia 24V/240V non incluso, da ordinare / Power supply 24V/240V for interface not included, to be ordered (cod.RF25755, cod.RF25749 or cod.RF25756)

Interfaccia di controllo DALI PWM 2CH 24Vdc 90W IP20. Alimentatore non incluso.	DALI PWM control interface 24Vdc 90W IP20. Power supply not included.	F990B09A000		
---	---	-------------	---	--

Outgraze 35

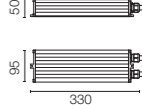
Alimentatore per versione 24V / Power supply for 24V version

Alimentatore per installazione remota 24V DC 50W / 120-240V IP67 Classe II selv.	Power supply for remote installation 24V DC 50W / 120-240V IP67 Class II selv.	*RF25755		
Alimentatore per installazione remota 24V DC 70W / 220-240V IP67 Classe II selv.	Power supply for remote installation 24V DC 70W / 220-240V IP67 Class II selv.	*RF25749		
Alimentatore per installazione remota 24V DC 96W / 120-240V IP67 Classe II selv.	Power supply for remote installation 24V DC 96W / 120-240V IP67 Class II selv.	*RF25756		

* Numero massimo di apparecchi per alimentatore / Maximum number of luminaires per power supply.

Numero massimo di apparecchi per alimentatore (Vin220÷240). Dati indicativi da verificare con le specifiche condizioni di installazione.	Maximum number of luminaires per power supply. (220÷240 V). These data must be checked taking into account the specific installation conditions.	Acc. RF25755	Acc. RF25749	Acc. RF25756	L 300	L 600	L 900	L 1200
		6	8	12	6	3	2	2
					8	5	3	3
					12	6	4	3

Outgraze 35

48V versions

Schema elettrico n.1 / Wiring diagram n.1

Standard: spezzone di cavo in uscita 1000 mm (accessori per collegamento da ordinare) / 1000 mm length prewired cable (connecting accessory to be separately ordered)

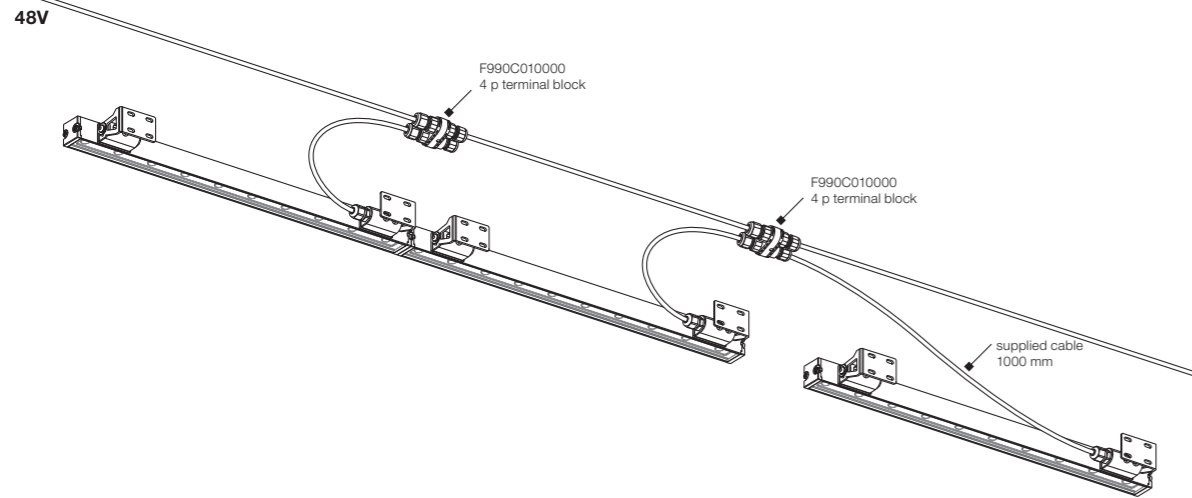

Schema elettrico n.2 / Wiring diagram n.2

Quick Install I H2O Stop Fast Connect: connettore H2O Stop Plug&Play preinstallato per connessione rapida (accessori per collegamento da ordinare) / Prewired H2O Stop Plug&Play connector for an easy/rapid connection (connecting accessory to be ordered separately)

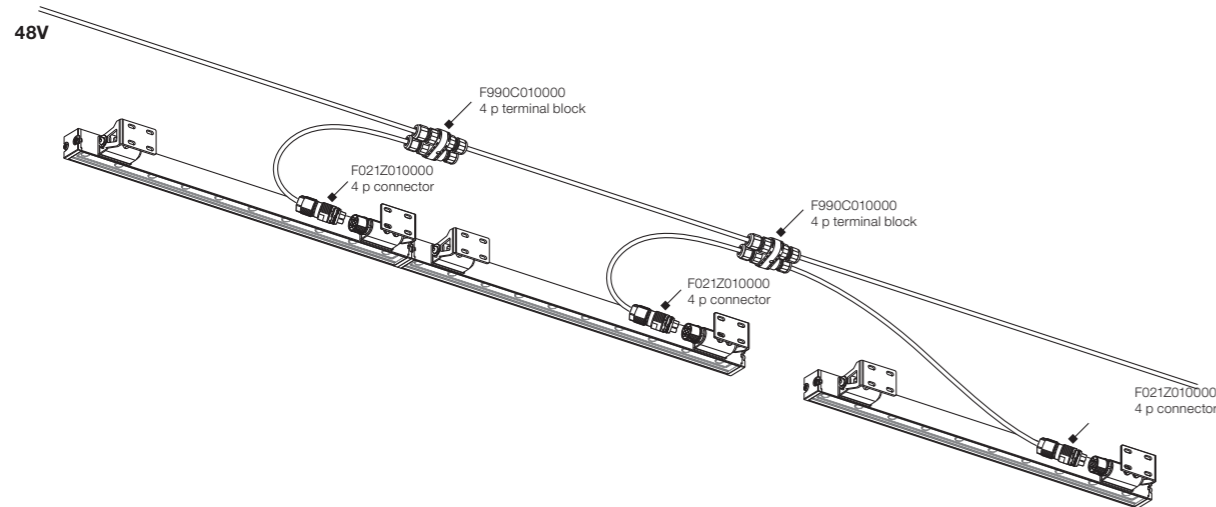

Schema elettrico n.3 / Wiring diagram n.3

Continous Line I/O H2O Stop Fast Connect: connettori H2O Stop Plug&Play preinstallati per connessione in linea (accessori per collegamento da ordinare) / Prewired H2O Stop Plug&Play connectors for an easy in line connection (connecting accessory to be ordered separately)

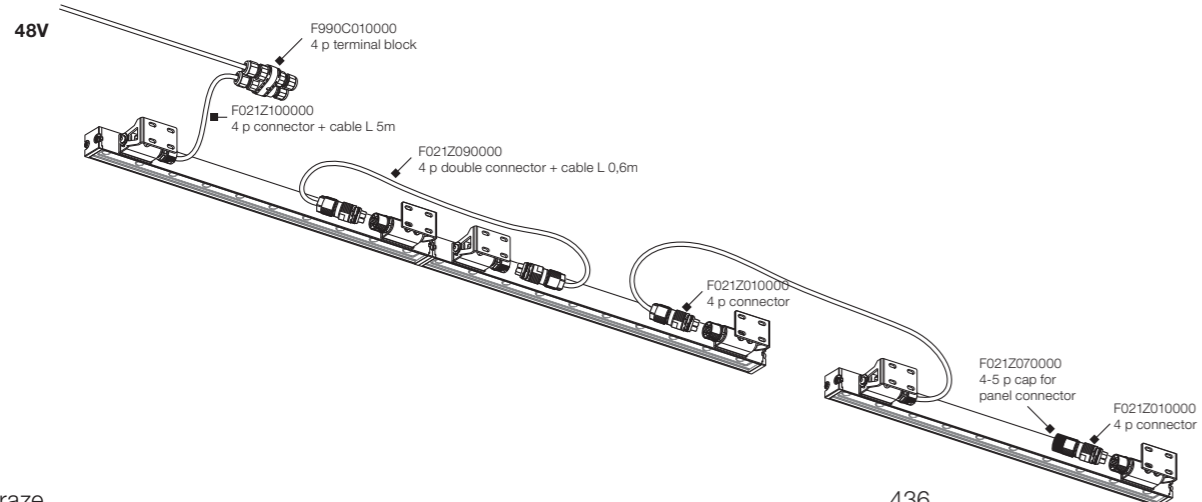

Outgraze 35

24V (Easy) and Tunable White versions

Schema elettrico n.4 / Wiring diagram n.4

Standard: spezzone di cavo in uscita 1000 mm (accessori per collegamento da ordinare) / 1000 mm length prewired cable (connecting accessory to be separately ordered)

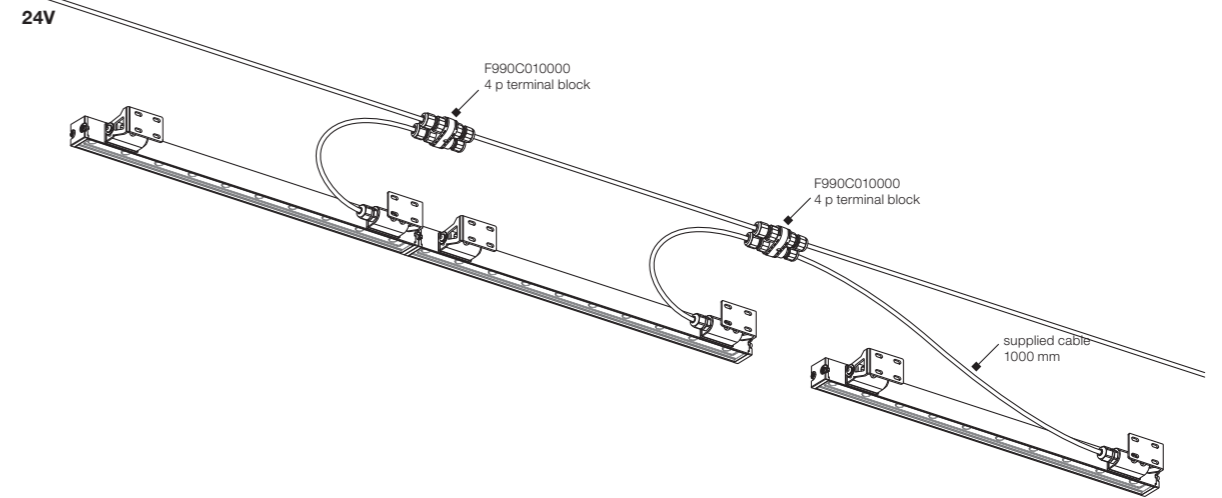

Schema elettrico n.5 / Wiring diagram n.5

Quick Install I H2O Stop Fast Connect: connettore H2O Stop Plug&Play preinstallato per connessione rapida (accessori per collegamento da ordinare) / Prewired H2O Stop Plug&Play connector for an easy/rapid connection (connecting accessory to be ordered separately)

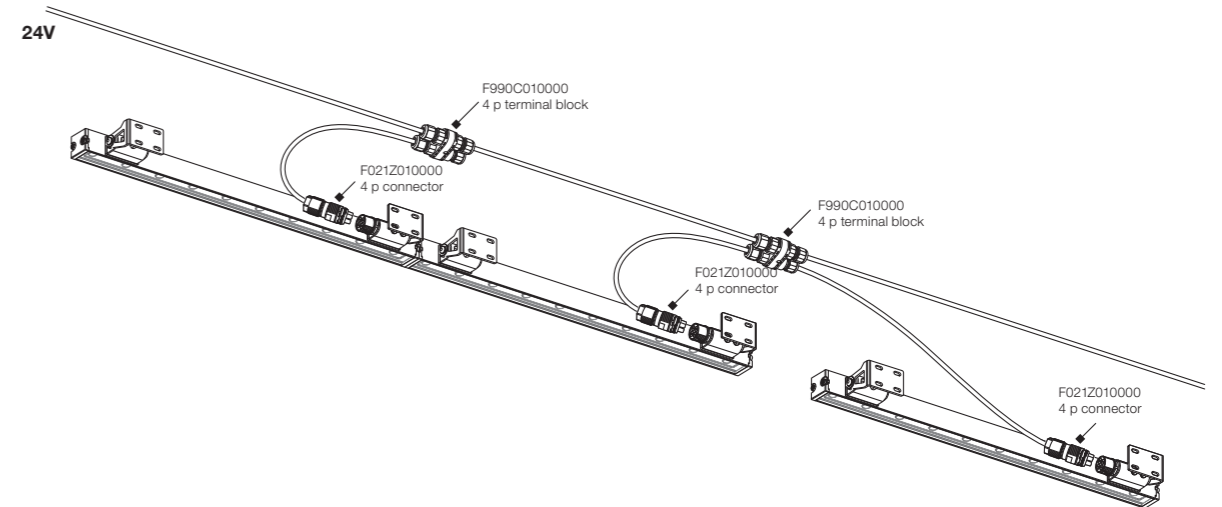

Schema elettrico n.6 / Wiring diagram n.6

Continous Line I/O H2O Stop Fast Connect: connettori H2O Stop Plug&Play preinstallati per connessione in linea (accessori per collegamento da ordinare) / Prewired H2O Stop Plug&Play connectors for an easy in line connection (connecting accessory to be ordered separately)

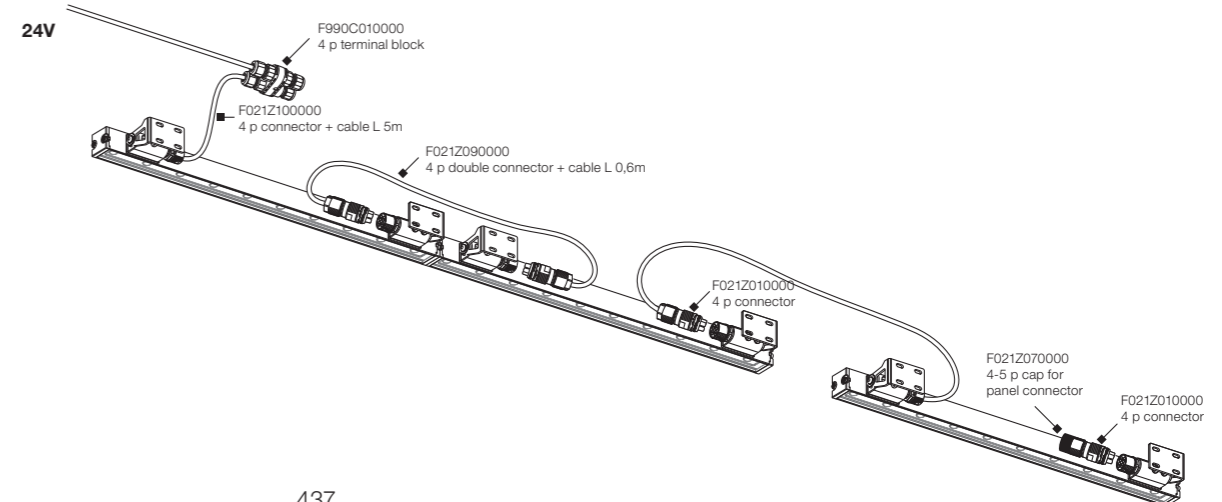

Outgraze 50 L 300 - Non Dimmable

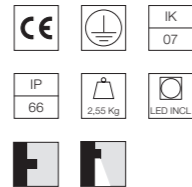
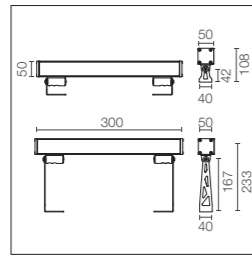

Alimentazione elettrica 220/240V integrata. Staffe di installazione da ordinare separatamente. Vetro trasparente extra chiaro, esclusa versione DIFFUSED con vetro sabbatiato. A richiesta versione SMART (potenza 6W - flusso -30% lm).

Integrated 220/240V power supply. Installation brackets, to be ordered separately. Extra clear transparent glass, excluding the DIFFUSE version with sandblasted glass. SMART version available upon request (power 6W-flux-30% lm).

Power Led: 8W - 835 lm ≠ *FIXT 685 lm - 2700K/CRI 80 - 220-240V / 8W - 864 lm ≠ *FIXT 709 lm - 3000K/CRI 80 - 220-240V / 8W - 894 lm ≠ *FIXT 734 lm - 4000K/CRI 80 - 220-240V
*FIXT lm = Medium Optic

¹Standard - Schema elettrico n.7 page 461 / Wiring diagram n.7 page 461

- | | | |
|---------------|---------------|---------------|
| 2700K | 3000K | 4000K |
| ○ F021A21A001 | ○ F021A31A001 | ○ F021A41A001 |
| ● F021A21A006 | ● F021A31A006 | ● F021A41A006 |
| ● F021A21A012 | ● F021A31A012 | ● F021A41A012 |
| ● F021A21A018 | ● F021A31A018 | ● F021A41A018 |
| ● F021A21A030 | ● F021A31A030 | ● F021A41A030 |
| ● F021A21A033 | ● F021A31A033 | ● F021A41A033 |

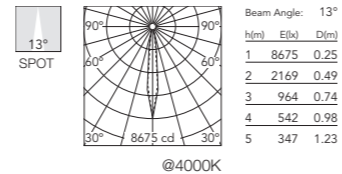

²Quick Install I H2O Stop Fast Connect - Schema elettrico n.8 page 461 / Wiring diagram n.8 page 461

- | | | |
|---------------|---------------|---------------|
| 2700K | 3000K | 4000K |
| ○ F021B21A001 | ○ F021B31A001 | ○ F021B41A001 |
| ● F021B21A006 | ● F021B31A006 | ● F021B41A006 |
| ● F021B21A012 | ● F021B31A012 | ● F021B41A012 |
| ● F021B21A018 | ● F021B31A018 | ● F021B41A018 |
| ● F021B21A030 | ● F021B31A030 | ● F021B41A030 |
| ● F021B21A033 | ● F021B31A033 | ● F021B41A033 |

¹Standard - Schema elettrico n.7 page 461 / Wiring diagram n.7 page 461

- | | | |
|---------------|---------------|---------------|
| 2700K | 3000K | 4000K |
| ○ F021A25A001 | ○ F021A35A001 | ○ F021A45A001 |
| ● F021A25A006 | ● F021A35A006 | ● F021A45A006 |
| ● F021A25A012 | ● F021A35A012 | ● F021A45A012 |
| ● F021A25A018 | ● F021A35A018 | ● F021A45A018 |
| ● F021A25A030 | ● F021A35A030 | ● F021A45A030 |
| ● F021A25A033 | ● F021A35A033 | ● F021A45A033 |

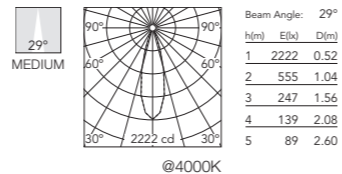

²Quick Install I H2O Stop Fast Connect - Schema elettrico n.8 page 461 / Wiring diagram n.8 page 461

- | | | |
|---------------|---------------|---------------|
| 2700K | 3000K | 4000K |
| ○ F021B25A001 | ○ F021B35A001 | ○ F021B45A001 |
| ● F021B25A006 | ● F021B35A006 | ● F021B45A006 |
| ● F021B25A012 | ● F021B35A012 | ● F021B45A012 |
| ● F021B25A018 | ● F021B35A018 | ● F021B45A018 |
| ● F021B25A030 | ● F021B35A030 | ● F021B45A030 |
| ● F021B25A033 | ● F021B35A033 | ● F021B45A033 |

¹Standard - Schema elettrico n.7 page 461 / Wiring diagram n.7 page 461

- | | | |
|---------------|---------------|---------------|
| 2700K | 3000K | 4000K |
| ○ F021A2AA001 | ○ F021A3AA001 | ○ F021A4AA001 |
| ● F021A2AA006 | ● F021A3AA006 | ● F021A4AA006 |
| ● F021A2AA012 | ● F021A3AA012 | ● F021A4AA012 |
| ● F021A2AA018 | ● F021A3AA018 | ● F021A4AA018 |
| ● F021A2AA030 | ● F021A3AA030 | ● F021A4AA030 |
| ● F021A2AA033 | ● F021A3AA033 | ● F021A4AA033 |

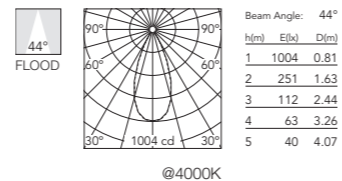

²Quick Install I H2O Stop Fast Connect - Schema elettrico n.8 page 461 / Wiring diagram n.8 page 461

- | | | |
|---------------|---------------|---------------|
| 2700K | 3000K | 4000K |
| ○ F021B2AA001 | ○ F021B3AA001 | ○ F021B4AA001 |
| ● F021B2AA006 | ● F021B3AA006 | ● F021B4AA006 |
| ● F021B2AA012 | ● F021B3AA012 | ● F021B4AA012 |
| ● F021B2AA018 | ● F021B3AA018 | ● F021B4AA018 |
| ● F021B2AA030 | ● F021B3AA030 | ● F021B4AA030 |
| ● F021B2AA033 | ● F021B3AA033 | ● F021B4AA033 |

¹Standard - Schema elettrico n.7 page 461 / Wiring diagram n.7 page 461

- | | | |
|---------------|---------------|---------------|
| 2700K | 3000K | 4000K |
| ○ F021A2EA001 | ○ F021A3EA001 | ○ F021A4EA001 |
| ● F021A2EA006 | ● F021A3EA006 | ● F021A4EA006 |
| ● F021A2EA012 | ● F021A3EA012 | ● F021A4EA012 |
| ● F021A2EA018 | ● F021A3EA018 | ● F021A4EA018 |
| ● F021A2EA030 | ● F021A3EA030 | ● F021A4EA030 |
| ● F021A2EA033 | ● F021A3EA033 | ● F021A4EA033 |

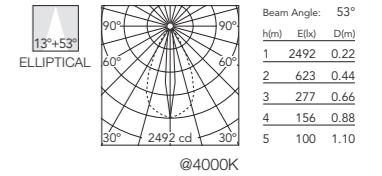

²Quick Install I H2O Stop Fast Connect - Schema elettrico n.8 page 461 / Wiring diagram n.8 page 461

- | | | |
|---------------|---------------|---------------|
| 2700K | 3000K | 4000K |
| ○ F021B2EA001 | ○ F021B3EA001 | ○ F021B4EA001 |
| ● F021B2EA006 | ● F021B3EA006 | ● F021B4EA006 |
| ● F021B2EA012 | ● F021B3EA012 | ● F021B4EA012 |
| ● F021B2EA018 | ● F021B3EA018 | ● F021B4EA018 |
| ● F021B2EA030 | ● F021B3EA030 | ● F021B4EA030 |
| ● F021B2EA033 | ● F021B3EA033 | ● F021B4EA033 |

¹Standard - Schema elettrico n.7 page 461 / Wiring diagram n.7 page 461

- | | | |
|---------------|---------------|---------------|
| 2700K | 3000K | 4000K |
| ○ F021A2JA001 | ○ F021A3JA001 | ○ F021A4JA001 |
| ● F021A2JA006 | ● F021A3JA006 | ● F021A4JA006 |
| ● F021A2JA012 | ● F021A3JA012 | ● F021A4JA012 |
| ● F021A2JA018 | ● F021A3JA018 | ● F021A4JA018 |
| ● F021A2JA030 | ● F021A3JA030 | ● F021A4JA030 |
| ● F021A2JA033 | ● F021A3JA033 | ● F021A4JA033 |

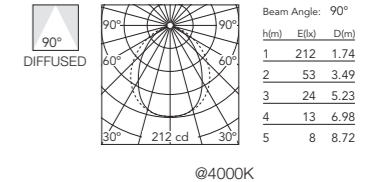

²Quick Install I H2O Stop Fast Connect - Schema elettrico n.8 page 461 / Wiring diagram n.8 page 461

- | | | |
|---------------|---------------|---------------|
| 2700K | 3000K | 4000K |
| ○ F021B2JA001 | ○ F021B3JA001 | ○ F021B4JA001 |
| ● F021B2JA006 | ● F021B3JA006 | ● F021B4JA006 |
| ● F021B2JA012 | ● F021B3JA012 | ● F021B4JA012 |
| ● F021B2JA018 | ● F021B3JA018 | ● F021B4JA018 |
| ● F021B2JA030 | ● F021B3JA030 | ● F021B4JA030 |
| ● F021B2JA033 | ● F021B3JA033 | ● F021B4JA033 |

¹Standard Version: spezzone di cavo in uscita 1000 mm (accessori per collegamento da ordinare) / 1000 mm lenght prewired cable (connecting accessory to be separately ordered).

²Quick Install In H2O Stop Version: connettore H2O Stop Plug&Play preinstallato per connessione rapida (accessori per collegamento da ordinare) / Prewired H2O Stop Plug&Play connector for an easy/rapid connection (connecting accessory to be ordered separately).

Outgraze 50 L 600 - Non Dimmable

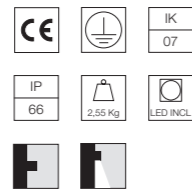
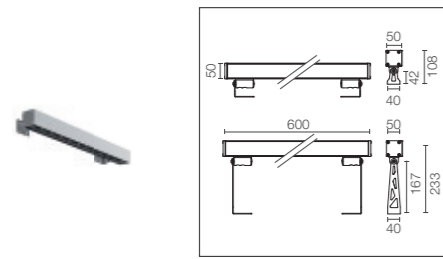

Alimentazione elettrica 220/240V integrata. Staffe di installazione da ordinare separatamente. Vetro trasparente extra chiaro, esclusa versione DIFFUSED con vetro sabbatiato. A richiesta versione SMART (potenza 10,5W - flusso -30% lm).

Integrated 220/240V power supply. Installation brackets, to be ordered separately. Extra clear transparent glass, excluding the DIFFUSE version with sandblasted glass. SMART version available upon request (power 10,5W - flux -30% lm).

Power Led: 14,5W - 1669 lm ≠ *FIXT 1369 lm - 2700K/CRI 80 - 220-240V /14,5W - 1729 lm ≠ *FIXT 1418 lm - 3000K/CRI 80 - 220-240V / 14,5W - 1788 lm ≠ *FIXT 1467 lm - 4000K/CRI 80 -220-240V
 *FIXT lm = Medium Optic

¹Standard - Schema elettrico n.7 page 461 / Wiring diagram n.7 page 461

- | | | |
|---------------|---------------|---------------|
| 2700K | 3000K | 4000K |
| ○ F021A22A001 | ○ F021A32A001 | ○ F021A42A001 |
| ● F021A22A006 | ● F021A32A006 | ● F021A42A006 |
| ● F021A22A012 | ● F021A32A012 | ● F021A42A012 |
| ● F021A22A018 | ● F021A32A018 | ● F021A42A018 |
| ● F021A22A030 | ● F021A32A030 | ● F021A42A030 |
| ● F021A22A033 | ● F021A32A033 | ● F021A42A033 |

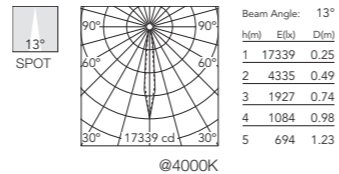

²Quick Install I H2O Stop Fast Connect - Schema elettrico n.8 page 461 / Wiring diagram n.8 page 461

- | | | |
|---------------|---------------|---------------|
| 2700K | 3000K | 4000K |
| ○ F021B22A001 | ○ F021B32A001 | ○ F021B42A001 |
| ● F021B22A006 | ● F021B32A006 | ● F021B42A006 |
| ● F021B22A012 | ● F021B32A012 | ● F021B42A012 |
| ● F021B22A018 | ● F021B32A018 | ● F021B42A018 |
| ● F021B22A030 | ● F021B32A030 | ● F021B42A030 |
| ● F021B22A033 | ● F021B32A033 | ● F021B42A033 |

³Continuous Line I/O H2O Stop Fast Connect - Schema elettrico n.9 page 461 / Wiring diagram n.9 page 461

- | | | |
|---------------|---------------|---------------|
| 2700K | 3000K | 4000K |
| ○ F021C22A001 | ○ F021C32A001 | ○ F021C42A001 |
| ● F021C22A006 | ● F021C32A006 | ● F021C42A006 |
| ● F021C22A012 | ● F021C32A012 | ● F021C42A012 |
| ● F021C22A018 | ● F021C32A018 | ● F021C42A018 |
| ● F021C22A030 | ● F021C32A030 | ● F021C42A030 |
| ● F021C22A033 | ● F021C32A033 | ● F021C42A033 |

¹Standard - Schema elettrico n.7 page 461 / Wiring diagram n.7 page 461

- | | | |
|---------------|---------------|---------------|
| 2700K | 3000K | 4000K |
| ○ F021A26A001 | ○ F021A36A001 | ○ F021A46A001 |
| ● F021A26A006 | ● F021A36A006 | ● F021A46A006 |
| ● F021A26A012 | ● F021A36A012 | ● F021A46A012 |
| ● F021A26A018 | ● F021A36A018 | ● F021A46A018 |
| ● F021A26A030 | ● F021A36A030 | ● F021A46A030 |
| ● F021A26A033 | ● F021A36A033 | ● F021A46A033 |

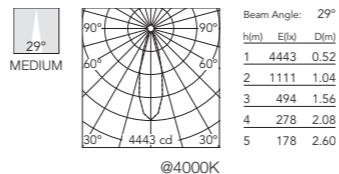

²Quick Install I H2O Stop Fast Connect - Schema elettrico n.8 page 461 / Wiring diagram n.8 page 461

- | | | |
|---------------|---------------|---------------|
| 2700K | 3000K | 4000K |
| ○ F021B26A001 | ○ F021B36A001 | ○ F021B46A001 |
| ● F021B26A006 | ● F021B36A006 | ● F021B46A006 |
| ● F021B26A012 | ● F021B36A012 | ● F021B46A012 |
| ● F021B26A018 | ● F021B36A018 | ● F021B46A018 |
| ● F021B26A030 | ● F021B36A030 | ● F021B46A030 |
| ● F021B26A033 | ● F021B36A033 | ● F021B46A033 |

³Continuous Line I/O H2O Stop Fast Connect - Schema elettrico n.9 page 461 / Wiring diagram n.9 page 461

- | | | |
|---------------|---------------|---------------|
| 2700K | 3000K | 4000K |
| ○ F021C26A001 | ○ F021C36A001 | ○ F021C46A001 |
| ● F021C26A006 | ● F021C36A006 | ● F021C46A006 |
| ● F021C26A012 | ● F021C36A012 | ● F021C46A012 |
| ● F021C26A018 | ● F021C36A018 | ● F021C46A018 |
| ● F021C26A030 | ● F021C36A030 | ● F021C46A030 |
| ● F021C26A033 | ● F021C36A033 | ● F021C46A033 |

¹Standard Version: spezzone di cavo in uscita 1000 mm (accessori per collegamento da ordinare) / 1000 mm length prewired cable (connecting accessory to be separately ordered).

²Quick Install In H2O Stop Version: connettore H2O Stop Plug&Play preinstallato per connessione rapida (accessori per collegamento da ordinare) / Prewired H2O Stop Plug&Play connector for an easy/rapid connection (connecting accessory to be ordered separately).

³Continuous Line In/Out H2O Stop Version: connettori H2O Stop Plug&Play preinstallati per connessione in linea (accessori per collegamento da ordinare) / Prewired H2O Stop Plug&Play connectors for an easy in line connection (connecting accessory to be ordered separately).

¹Standard - Schema elettrico n.7 page 461 / Wiring diagram n.7 page 461

- | | | |
|---------------|---------------|---------------|
| 2700K | 3000K | 4000K |
| ○ F021A2BA001 | ○ F021A3BA001 | ○ F021A4BA001 |
| ● F021A2BA006 | ● F021A3BA006 | ● F021A4BA006 |
| ● F021A2BA012 | ● F021A3BA012 | ● F021A4BA012 |
| ● F021A2BA018 | ● F021A3BA018 | ● F021A4BA018 |
| ● F021A2BA030 | ● F021A3BA030 | ● F021A4BA030 |
| ● F021A2BA033 | ● F021A3BA033 | ● F021A4BA033 |

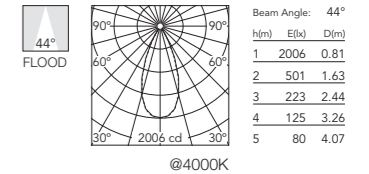

²Quick Install I H2O Stop Fast Connect - Schema elettrico n.8 page 461 / Wiring diagram n.8 page 461

- | | | |
|---------------|---------------|---------------|
| 2700K | 3000K | 4000K |
| ○ F021B2BA001 | ○ F021B3BA001 | ○ F021B4BA001 |
| ● F021B2BA006 | ● F021B3BA006 | ● F021B4BA006 |
| ● F021B2BA012 | ● F021B3BA012 | ● F021B4BA012 |
| ● F021B2BA018 | ● F021B3BA018 | ● F021B4BA018 |
| ● F021B2BA030 | ● F021B3BA030 | ● F021B4BA030 |
| ● F021B2BA033 | ● F021B3BA033 | ● F021B4BA033 |

³Continuous Line I/O H2O Stop Fast Connect - Schema elettrico n.9 page 461 / Wiring diagram n.9 page 461

- | | | |
|---------------|---------------|---------------|
| 2700K | 3000K | 4000K |
| ○ F021C2BA001 | ○ F021C3BA001 | ○ F021C4BA001 |
| ● F021C2BA006 | ● F021C3BA006 | ● F021C4BA006 |
| ● F021C2BA012 | ● F021C3BA012 | ● F021C4BA012 |
| ● F021C2BA018 | ● F021C3BA018 | ● F021C4BA018 |
| ● F021C2BA030 | ● F021C3BA030 | ● F021C4BA030 |
| ● F021C2BA033 | ● F021C3BA033 | ● F021C4BA033 |

¹Standard - Schema elettrico n.7 page 461 / Wiring diagram n.7 page 461

- | | | |
|---------------|---------------|---------------|
| 2700K | 3000K | 4000K |
| ○ F021A2FA001 | ○ F021A3FA001 | ○ F021A4FA001 |
| ● F021A2FA006 | ● F021A3FA006 | ● F021A4FA006 |
| ● F021A2FA012 | ● F021A3FA012 | ● F021A4FA012 |
| ● F021A2FA018 | ● F021A3FA018 | ● F021A4FA018 |
| ● F021A2FA030 | ● F021A3FA030 | ● F021A4FA030 |
| ● F021A2FA033 | ● F021A3FA033 | ● F021A4FA033 |

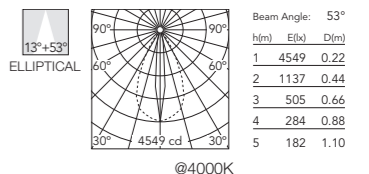

²Quick Install I H2O Stop Fast Connect - Schema elettrico n.8 page 461 / Wiring diagram n.8 page 461

- | | | |
|---------------|---------------|---------------|
| 2700K | 3000K | 4000K |
| ○ F021B2FA001 | ○ F021B3FA001 | ○ F021B4FA001 |
| ● F021B2FA006 | ● F021B3FA006 | ● F021B4FA006 |
| ● F021B2FA012 | ● F021B3FA012 | ● F021B4FA012 |
| ● F021B2FA018 | ● F021B3FA018 | ● F021B4FA018 |
| ● F021B2FA030 | ● F021B3FA030 | ● F021B4FA030 |
| ● F021B2FA033 | ● F021B3FA033 | ● F021B4FA033 |

³Continuous Line I/O H2O Stop Fast Connect - Schema elettrico n.9 page 461 / Wiring diagram n.9 page 461

- | | | |
|---------------|---------------|---------------|
| 2700K | 3000K | 4000K |
| ○ F021C2FA001 | ○ F021C3FA001 | ○ F021C4FA001 |
| ● F021C2FA006 | ● F021C3FA006 | ● F021C4FA006 |
| ● F021C2FA012 | ● F021C3FA012 | ● F021C4FA012 |
| ● F021C2FA018 | ● F021C3FA018 | ● F021C4FA018 |
| ● F021C2FA030 | ● F021C3FA030 | ● F021C4FA030 |
| ● F021C2FA033 | ● F021C3FA033 | ● F021C4FA033 |

¹Standard - Schema elettrico n.7 page 461 / Wiring diagram n.7 page 461

- | | | |
|---------------|---------------|---------------|
| 2700K | 3000K | 4000K |
| ○ F021A2KA001 | ○ F021A3KA001 | ○ F021A4KA001 |
| ● F021A2KA006 | ● F021A3KA006 | ● F021A4KA006 |
| ● F021A2KA012 | ● F021A3KA012 | ● F021A4KA012 |
| ● F021A2KA018 | ● F021A3KA018 | ● F021A4KA018 |
| ● F021A2KA030 | ● F021A3KA030 | ● F021A4KA030 |
| ● F021A2KA033 | ● F021A3KA033 | ● F021A4KA033 |

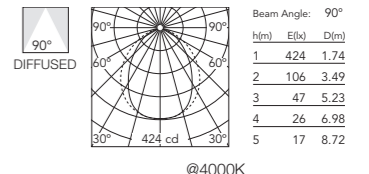

²Quick Install I H2O Stop Fast Connect - Schema elettrico n.8 page 461 / Wiring diagram n.8 page 461

- | | | |
|---------------|---------------|---------------|
| 2700K | 3000K | 4000K |
| ○ F021B2KA001 | ○ F021B3KA001 | ○ F021B4KA001 |
| ● F021B2KA006 | ● F021B3KA006 | ● F021B4KA006 |
| ● F021B2KA012 | ● F021B3KA012 | ● F021B4KA012 |
| ● F021B2KA018 | ● F021B3KA018 | ● F021B4KA018 |
| ● F021B2KA030 | ● F021B3KA030 | ● F021B4KA030 |
| ● F021B2KA033 | ● F021B3KA033 | ● F021B4KA033 |

³Continuous Line I/O H2O Stop Fast Connect - Schema elettrico n.9 page 461 / Wiring diagram n.9 page 461

- | | | |
|---------------|---------------|---------------|
| 2700K | 3000K | 4000K |
| ○ F021C2KA001 | ○ F021C3KA001 | ○ F021C4KA001 |
| ● F021C2KA006 | ● F021C3KA006 | ● F021C4KA006 |
| ● F021C2KA012 | ● F021C3KA012 | ● F021C4KA012 |
| ● F021C2KA018 | ● F021C3KA018 | ● F021C4KA018 |
| ● F021C2KA030 | ● F021C3KA030 | ● F021C4KA030 |
| ● F021C2KA033 | ● F021C3KA033 | ● F021C4KA033 |

Outgraze 50 L 900 - Non Dimmable

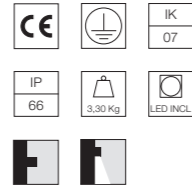
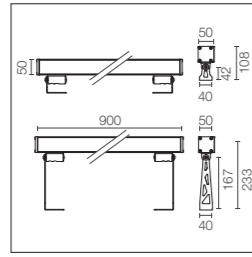

Alimentazione elettrica 220/240V integrata. Staffe di installazione da ordinare separatamente. Vetro trasparente extra chiaro, esclusa versione DIFFUSED con vetro sabbatiato. A richiesta versione SMART (potenza 15,5W - flusso - 30% lm).

Integrated 220/240V power supply. Installation brackets, to be ordered separately. Extra clear transparent glass, excluding the DIFFUSE version with sandblasted glass. SMART version available upon request (power 15,5W - flux -30% lm).

Power Led: 20W - 2504 lm ≠ *FIXT 2054 lm - 2700K/CRI 80 - 220-240V / 20W - 2593 lm ≠ *FIXT 2127 lm - 3000K/CRI 80 - 220-240V / 20W - 2683 lm ≠ *FIXT 2201 lm - 4000K/CRI 80 -220-240V
*FIXT lm = Medium Optic

¹Standard - Schema elettrico n.7 page 461 / Wiring diagram n.7 page 461

- | | | |
|---------------|---------------|---------------|
| 2700K | 3000K | 4000K |
| ○ F021A23A001 | ○ F021A33A001 | ○ F021A43A001 |
| ● F021A23A006 | ● F021A33A006 | ● F021A43A006 |
| ● F021A23A012 | ● F021A33A012 | ● F021A43A012 |
| ● F021A23A018 | ● F021A33A018 | ● F021A43A018 |
| ● F021A23A030 | ● F021A33A030 | ● F021A43A030 |
| ● F021A23A033 | ● F021A33A033 | ● F021A43A033 |

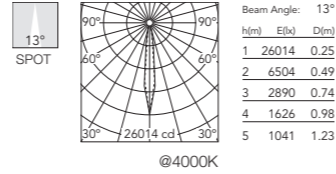

²Quick Install I H2O Stop Fast Connect - Schema elettrico n.8 page 461 / Wiring diagram n.8 page 461

- | | | |
|---------------|---------------|---------------|
| 2700K | 3000K | 4000K |
| ○ F021B23A001 | ○ F021B33A001 | ○ F021B43A001 |
| ● F021B23A006 | ● F021B33A006 | ● F021B43A006 |
| ● F021B23A012 | ● F021B33A012 | ● F021B43A012 |
| ● F021B23A018 | ● F021B33A018 | ● F021B43A018 |
| ● F021B23A030 | ● F021B33A030 | ● F021B43A030 |
| ● F021B23A033 | ● F021B33A033 | ● F021B43A033 |

³Continuous Line I/O H2O Stop Fast Connect - Schema elettrico n.9 page 461 / Wiring diagram n.9 page 461

- | | | |
|---------------|---------------|---------------|
| 2700K | 3000K | 4000K |
| ○ F021C23A001 | ○ F021C33A001 | ○ F021C43A001 |
| ● F021C23A006 | ● F021C33A006 | ● F021C43A006 |
| ● F021C23A012 | ● F021C33A012 | ● F021C43A012 |
| ● F021C23A018 | ● F021C33A018 | ● F021C43A018 |
| ● F021C23A030 | ● F021C33A030 | ● F021C43A030 |
| ● F021C23A033 | ● F021C33A033 | ● F021C43A033 |

¹Standard - Schema elettrico n.7 page 461 / Wiring diagram n.7 page 461

- | | | |
|---------------|---------------|---------------|
| 2700K | 3000K | 4000K |
| ○ F021A27A001 | ○ F021A37A001 | ○ F021A47A001 |
| ● F021A27A006 | ● F021A37A006 | ● F021A47A006 |
| ● F021A27A012 | ● F021A37A012 | ● F021A47A012 |
| ● F021A27A018 | ● F021A37A018 | ● F021A47A018 |
| ● F021A27A030 | ● F021A37A030 | ● F021A47A030 |
| ● F021A27A033 | ● F021A37A033 | ● F021A47A033 |

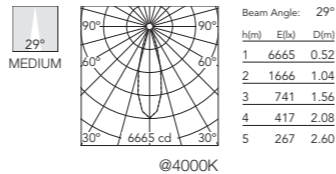

²Quick Install I H2O Stop Fast Connect - Schema elettrico n.8 page 461 / Wiring diagram n.8 page 461

- | | | |
|---------------|---------------|---------------|
| 2700K | 3000K | 4000K |
| ○ F021B27A001 | ○ F021B37A001 | ○ F021B47A001 |
| ● F021B27A006 | ● F021B37A006 | ● F021B47A006 |
| ● F021B27A012 | ● F021B37A012 | ● F021B47A012 |
| ● F021B27A018 | ● F021B37A018 | ● F021B47A018 |
| ● F021B27A030 | ● F021B37A030 | ● F021B47A030 |
| ● F021B27A033 | ● F021B37A033 | ● F021B47A033 |

³Continuous Line I/O H2O Stop Fast Connect - Schema elettrico n.9 page 461 / Wiring diagram n.9 page 461

- | | | |
|---------------|---------------|---------------|
| 2700K | 3000K | 4000K |
| ○ F021C27A001 | ○ F021C37A001 | ○ F021C47A001 |
| ● F021C27A006 | ● F021C37A006 | ● F021C47A006 |
| ● F021C27A012 | ● F021C37A012 | ● F021C47A012 |
| ● F021C27A018 | ● F021C37A018 | ● F021C47A018 |
| ● F021C27A030 | ● F021C37A030 | ● F021C47A030 |
| ● F021C27A033 | ● F021C37A033 | ● F021C47A033 |

¹Standard Version: spezzone di cavo in uscita 1000 mm (accessori per collegamento da ordinare) / 1000 mm length prewired cable (connecting accessory to be separately ordered).

²Quick Install In H2O Stop Version: connettore H2O Stop Plug&Play preinstallato per connessione rapida (accessori per collegamento da ordinare) / Prewired H2O Stop Plug&Play connector for an easy/rapid connection (connecting accessory to be ordered separately).

³Continuous Line In/Out H2O Stop Version: connettori H2O Stop Plug&Play preinstallati per connessione in linea (accessori per collegamento da ordinare) / Prewired H2O Stop Plug&Play connectors for an easy in line connection (connecting accessory to be ordered separately).

¹Standard - Schema elettrico n.7 page 461 / Wiring diagram n.7 page 461

- | | | |
|---------------|---------------|---------------|
| 2700K | 3000K | 4000K |
| ○ F021A2CA001 | ○ F021A3CA001 | ○ F021A4CA001 |
| ● F021A2CA006 | ● F021A3CA006 | ● F021A4CA006 |
| ● F021A2CA012 | ● F021A3CA012 | ● F021A4CA012 |
| ● F021A2CA018 | ● F021A3CA018 | ● F021A4CA018 |
| ● F021A2CA030 | ● F021A3CA030 | ● F021A4CA030 |
| ● F021A2CA033 | ● F021A3CA033 | ● F021A4CA033 |

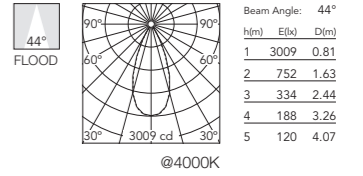

²Quick Install I H2O Stop Fast Connect - Schema elettrico n.8 page 461 / Wiring diagram n.8 page 461

- | | | |
|---------------|---------------|---------------|
| 2700K | 3000K | 4000K |
| ○ F021B2CA001 | ○ F021B3CA001 | ○ F021B4CA001 |
| ● F021B2CA006 | ● F021B3CA006 | ● F021B4CA006 |
| ● F021B2CA012 | ● F021B3CA012 | ● F021B4CA012 |
| ● F021B2CA018 | ● F021B3CA018 | ● F021B4CA018 |
| ● F021B2CA030 | ● F021B3CA030 | ● F021B4CA030 |
| ● F021B2CA033 | ● F021B3CA033 | ● F021B4CA033 |

³Continuous Line I/O H2O Stop Fast Connect - Schema elettrico n.9 page 461 / Wiring diagram n.9 page 461

- | | | |
|---------------|---------------|---------------|
| 2700K | 3000K | 4000K |
| ○ F021C2CA001 | ○ F021C3CA001 | ○ F021C4CA001 |
| ● F021C2CA006 | ● F021C3CA006 | ● F021C4CA006 |
| ● F021C2CA012 | ● F021C3CA012 | ● F021C4CA012 |
| ● F021C2CA018 | ● F021C3CA018 | ● F021C4CA018 |
| ● F021C2CA030 | ● F021C3CA030 | ● F021C4CA030 |
| ● F021C2CA033 | ● F021C3CA033 | ● F021C4CA033 |

¹Standard - Schema elettrico n.7 page 461 / Wiring diagram n.7 page 461

- | | | |
|---------------|---------------|---------------|
| 2700K | 3000K | 4000K |
| ○ F021A2GA001 | ○ F021A3GA001 | ○ F021A4GA001 |
| ● F021A2GA006 | ● F021A3GA006 | ● F021A4GA006 |
| ● F021A2GA012 | ● F021A3GA012 | ● F021A4GA012 |
| ● F021A2GA018 | ● F021A3GA018 | ● F021A4GA018 |
| ● F021A2GA030 | ● F021A3GA030 | ● F021A4GA030 |
| ● F021A2GA033 | ● F021A3GA033 | ● F021A4GA033 |

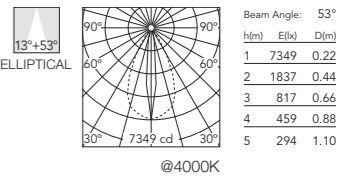

²Quick Install I H2O Stop Fast Connect - Schema elettrico n.8 page 461 / Wiring diagram n.8 page 461

- | | | |
|---------------|---------------|---------------|
| 2700K | 3000K | 4000K |
| ○ F021B2GA001 | ○ F021B3GA001 | ○ F021B4GA001 |
| ● F021B2GA006 | ● F021B3GA006 | ● F021B4GA006 |
| ● F021B2GA012 | ● F021B3GA012 | ● F021B4GA012 |
| ● F021B2GA018 | ● F021B3GA018 | ● F021B4GA018 |
| ● F021B2GA030 | ● F021B3GA030 | ● F021B4GA030 |
| ● F021B2GA033 | ● F021B3GA033 | ● F021B4GA033 |

³Continuous Line I/O H2O Stop Fast Connect - Schema elettrico n.9 page 461 / Wiring diagram n.9 page 461

- | | | |
|---------------|---------------|---------------|
| 2700K | 3000K | 4000K |
| ○ F021C2GA001 | ○ F021C3GA001 | ○ F021C4GA001 |
| ● F021C2GA006 | ● F021C3GA006 | ● F021C4GA006 |
| ● F021C2GA012 | ● F021C3GA012 | ● F021C4GA012 |
| ● F021C2GA018 | ● F021C3GA018 | ● F021C4GA018 |
| ● F021C2GA030 | ● F021C3GA030 | ● F021C4GA030 |
| ● F021C2GA033 | ● F021C3GA033 | ● F021C4GA033 |

¹Standard - Schema elettrico n.7 page 461 / Wiring diagram n.7 page 461

- | | | |
|---------------|---------------|---------------|
| 2700K | 3000K | 4000K |
| ○ F021A2LA001 | ○ F021A3LA001 | ○ F021A4LA001 |
| ● F021A2LA006 | ● F021A3LA006 | ● F021A4LA006 |
| ● F021A2LA012 | ● F021A3LA012 | ● F021A4LA012 |
| ● F021A2LA018 | ● F021A3LA018 | ● F021A4LA018 |
| ● F021A2LA030 | ● F021A3LA030 | ● F021A4LA030 |
| ● F021A2LA033 | ● F021A3LA033 | ● F021A4LA033 |

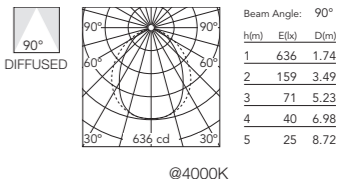

²Quick Install I H2O Stop -Fast Connect - Schema elettrico n.8 page 461 / Wiring diagram n.8 page 461

- | | | |
|---------------|---------------|---------------|
| 2700K | 3000K | 4000K |
| ○ F021B2LA001 | ○ F021B3LA001 | ○ F021B4LA001 |
| ● F021B2LA006 | ● F021B3LA006 | ● F021B4LA006 |
| ● F021B2LA012 | ● F021B3LA012 | ● F021B4LA012 |
| ● F021B2LA018 | ● F021B3LA018 | ● F021B4LA018 |
| ● F021B2LA030 | ● F021B3LA030 | ● F021B4LA030 |
| ● F021B2LA033 | ● F021B3LA033 | ● F021B4LA033 |

³Continuous Line I/O H2O Stop Fast Connect - Schema elettrico n.9 page 461 / Wiring diagram n.9 page 461

- | | | |
|---------------|---------------|---------------|
| 2700K | 3000K | 4000K |
| ○ F021C2LA001 | ○ F021C3LA001 | ○ F021C4LA001 |
| ● F021C2LA006 | ● F021C3LA006 | ● F021C4LA006 |
| ● F021C2LA012 | ● F021C3LA012 | ● F021C4LA012 |
| ● F021C2LA018 | ● F021C3LA018 | ● F021C4LA018 |
| ● F021C2LA030 | ● F021C3LA030 | ● F021C4LA030 |
| ● F021C2LA033 | ● F021C3LA033 | ● F021C4LA033 |

Outgraze 50 L 1200 - Non Dimmable

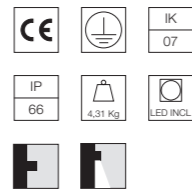
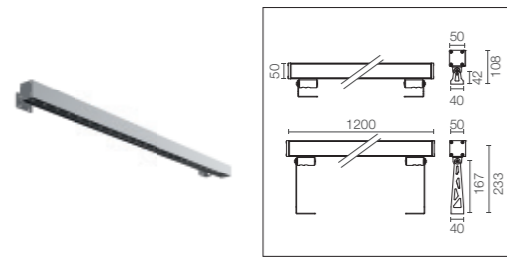

Alimentazione elettrica 220/240V integrata. Staffe di installazione da ordinare separatamente. Vetro trasparente extra chiaro, esclusa versione DIFFUSED con vetro sabbato. A richiesta versione SMART (potenza 18,5W - flusso -30% lm).

Integrated 220/240V power supply. Installation brackets, to be ordered separately. Extra clear transparent glass, excluding the DIFFUSE version with sandblasted glass. SMART version available upon request (power 18,5W - flux -30% lm).

Power Led: 27W - 3338 lm ≠ *FIXT 2739 lm - 2700K/CRI 80 - 220-240V / 27W - 3458 lm ≠ *FIXT 2836 lm - 3000K/CRI 80 - 220-240V / 27W - 3577 lm ≠ *FIXT 2934 lm - 4000K/CRI 80 -220-240V
*FIXT lm = Medium Optic

¹Standard - Schema elettrico n.7 page 461 / Wiring diagram n.7 page 461

- | | | |
|---------------|---------------|---------------|
| 2700K | 3000K | 4000K |
| ○ F021A24A001 | ○ F021A34A001 | ○ F021A44A001 |
| ● F021A24A006 | ● F021A34A006 | ● F021A44A006 |
| ● F021A24A033 | ● F021A34A033 | ● F021A44A033 |
| ● F021A24A030 | ● F021A34A030 | ● F021A44A030 |
| ● F021A24A018 | ● F021A34A018 | ● F021A44A018 |
| ● F021A24A012 | ● F021A34A012 | ● F021A44A012 |

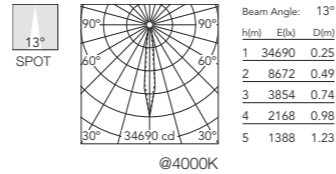

²Quick Install I H2O Stop Fast Connect - Schema elettrico n.8 page 461 / Wiring diagram n.8 page 461

- | | | |
|---------------|---------------|---------------|
| 2700K | 3000K | 4000K |
| ○ F021B24A001 | ○ F021B34A001 | ○ F021B44A001 |
| ● F021B24A006 | ● F021B34A006 | ● F021B44A006 |
| ● F021B24A033 | ● F021B34A033 | ● F021B44A033 |
| ● F021B24A030 | ● F021B34A030 | ● F021B44A030 |
| ● F021B24A018 | ● F021B34A018 | ● F021B44A018 |
| ● F021B24A012 | ● F021B34A012 | ● F021B44A012 |

³Continuous Line I/O H2O Stop Fast Connect - Schema elettrico n.9 page 461 / Wiring diagram n.9 page 461

- | | | |
|---------------|---------------|---------------|
| 2700K | 3000K | 4000K |
| ○ F021C24A001 | ○ F021C34A001 | ○ F021C44A001 |
| ● F021C24A006 | ● F021C34A006 | ● F021C44A006 |
| ● F021C24A033 | ● F021C34A033 | ● F021C44A033 |
| ● F021C24A030 | ● F021C34A030 | ● F021C44A030 |
| ● F021C24A018 | ● F021C34A018 | ● F021C44A018 |
| ● F021C24A012 | ● F021C34A012 | ● F021C44A012 |

¹Standard - Schema elettrico n.7 page 461 / Wiring diagram n.7 page 461

- | | | |
|---------------|---------------|---------------|
| 2700K | 3000K | 4000K |
| ○ F021A28A001 | ○ F021A38A001 | ○ F021A48A001 |
| ● F021A28A006 | ● F021A38A006 | ● F021A48A006 |
| ● F021A28A033 | ● F021A38A033 | ● F021A48A033 |
| ● F021A28A030 | ● F021A38A030 | ● F021A48A030 |
| ● F021A28A018 | ● F021A38A018 | ● F021A48A018 |
| ● F021A28A012 | ● F021A38A012 | ● F021A48A012 |

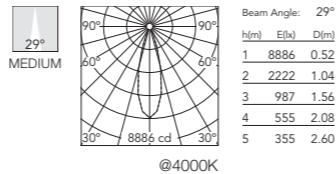

²Quick Install I H2O Stop Fast Connect - Schema elettrico n.8 page 461 / Wiring diagram n.8 page 461

- | | | |
|---------------|---------------|---------------|
| 2700K | 3000K | 4000K |
| ○ F021B28A001 | ○ F021B38A001 | ○ F021B48A001 |
| ● F021B28A006 | ● F021B38A006 | ● F021B48A006 |
| ● F021B28A033 | ● F021B38A033 | ● F021B48A033 |
| ● F021B28A030 | ● F021B38A030 | ● F021B48A030 |
| ● F021B28A018 | ● F021B38A018 | ● F021B48A018 |
| ● F021B28A012 | ● F021B38A012 | ● F021B48A012 |

³Continuous Line I/O H2O Stop Fast Connect - Schema elettrico n.9 page 461 / Wiring diagram n.9 page 461

- | | | |
|---------------|---------------|---------------|
| 2700K | 3000K | 4000K |
| ○ F021C28A001 | ○ F021C38A001 | ○ F021C48A001 |
| ● F021C28A006 | ● F021C38A006 | ● F021C48A006 |
| ● F021C28A033 | ● F021C38A033 | ● F021C48A033 |
| ● F021C28A030 | ● F021C38A030 | ● F021C48A030 |
| ● F021C28A018 | ● F021C38A018 | ● F021C48A018 |
| ● F021C28A012 | ● F021C38A012 | ● F021C48A012 |

¹Standard Version: spezzone di cavo in uscita 1000 mm (accessori per collegamento da ordinare) / 1000 mm length prewired cable (connecting accessory to be separately ordered).

²Quick Install In H2O Stop Version: connettore H2O Stop Plug&Play preinstallato per connessione rapida (accessori per collegamento da ordinare) / Prewired H2O Stop Plug&Play connector for an easy/rapid connection (connecting accessory to be ordered separately).

³Continuous Line In/Out H2O Stop Version: connettori H2O Stop Plug&Play preinstallati per connessione in linea (accessori per collegamento da ordinare) / Prewired H2O Stop Plug&Play connectors for an easy in line connection (connecting accessory to be ordered separately).

¹Standard - Schema elettrico n.7 page 461 / Wiring diagram n.7 page 461

- | | | |
|---------------|---------------|---------------|
| 2700K | 3000K | 4000K |
| ○ F021A2DA001 | ○ F021A3DA001 | ○ F021A4DA001 |
| ● F021A2DA006 | ● F021A3DA006 | ● F021A4DA006 |
| ● F021A2DA012 | ● F021A3DA012 | ● F021A4DA012 |
| ● F021A2DA018 | ● F021A3DA018 | ● F021A4DA018 |
| ● F021A2DA030 | ● F021A3DA030 | ● F021A4DA030 |
| ● F021A2DA033 | ● F021A3DA033 | ● F021A4DA033 |

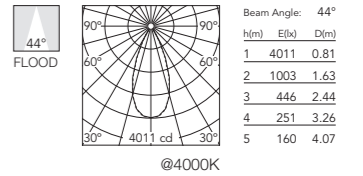

²Quick Install I H2O Stop Fast Connect - Schema elettrico n.8 page 461 / Wiring diagram n.8 page 461

- | | | |
|---------------|---------------|---------------|
| 2700K | 3000K | 4000K |
| ○ F021B2DA001 | ○ F021B3DA001 | ○ F021B4DA001 |
| ● F021B2DA006 | ● F021B3DA006 | ● F021B4DA006 |
| ● F021B2DA012 | ● F021B3DA012 | ● F021B4DA012 |
| ● F021B2DA018 | ● F021B3DA018 | ● F021B4DA018 |
| ● F021B2DA030 | ● F021B3DA030 | ● F021B4DA030 |
| ● F021B2DA033 | ● F021B3DA033 | ● F021B4DA033 |

³Continuous Line I/O H2O Stop Fast Connect - Schema elettrico n.9 page 461 / Wiring diagram n.9 page 461

- | | | |
|---------------|---------------|---------------|
| 2700K | 3000K | 4000K |
| ○ F021C2DA001 | ○ F021C3DA001 | ○ F021C4DA001 |
| ● F021C2DA006 | ● F021C3DA006 | ● F021C4DA006 |
| ● F021C2DA012 | ● F021C3DA012 | ● F021C4DA012 |
| ● F021C2DA018 | ● F021C3DA018 | ● F021C4DA018 |
| ● F021C2DA030 | ● F021C3DA030 | ● F021C4DA030 |
| ● F021C2DA033 | ● F021C3DA033 | ● F021C4DA033 |

¹Standard - Schema elettrico n.7 page 461 / Wiring diagram n.7 page 461

- | | | |
|---------------|---------------|---------------|
| 2700K | 3000K | 4000K |
| ○ F021A2HA001 | ○ F021A3HA001 | ○ F021A4HA001 |
| ● F021A2HA006 | ● F021A3HA006 | ● F021A4HA006 |
| ● F021A2HA012 | ● F021A3HA012 | ● F021A4HA012 |
| ● F021A2HA018 | ● F021A3HA018 | ● F021A4HA018 |
| ● F021A2HA030 | ● F021A3HA030 | ● F021A4HA030 |
| ● F021A2HA033 | ● F021A3HA033 | ● F021A4HA033 |

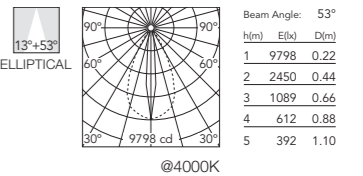

²Quick Install I H2O Stop Fast Connect - Schema elettrico n.8 page 461 / Wiring diagram n.8 page 461

- | | | |
|---------------|---------------|---------------|
| 2700K | 3000K | 4000K |
| ○ F021B2HA001 | ○ F021B3HA001 | ○ F021B4HA001 |
| ● F021B2HA006 | ● F021B3HA006 | ● F021B4HA006 |
| ● F021B2HA012 | ● F021B3HA012 | ● F021B4HA012 |
| ● F021B2HA018 | ● F021B3HA018 | ● F021B4HA018 |
| ● F021B2HA030 | ● F021B3HA030 | ● F021B4HA030 |
| ● F021B2HA033 | ● F021B3HA033 | ● F021B4HA033 |

³Continuous Line I/O H2O Stop Fast Connect - Schema elettrico n.9 page 461 / Wiring diagram n.9 page 461

- | | | |
|---------------|---------------|---------------|
| 2700K | 3000K | 4000K |
| ○ F021C2HA001 | ○ F021C3HA001 | ○ F021C4HA001 |
| ● F021C2HA006 | ● F021C3HA006 | ● F021C4HA006 |
| ● F021C2HA012 | ● F021C3HA012 | ● F021C4HA012 |
| ● F021C2HA018 | ● F021C3HA018 | ● F021C4HA018 |
| ● F021C2HA030 | ● F021C3HA030 | ● F021C4HA030 |
| ● F021C2HA033 | ● F021C3HA033 | ● F021C4HA033 |

¹Standard - Schema elettrico n.7 page 461 / Wiring diagram n.7 page 461

- | | | |
|---------------|---------------|---------------|
| 2700K | 3000K | 4000K |
| ○ F021A2MA001 | ○ F021A3MA001 | ○ F021A4MA001 |
| ● F021A2MA006 | ● F021A3MA006 | ● F021A4MA006 |
| ● F021A2MA012 | ● F021A3MA012 | ● F021A4MA012 |
| ● F021A2MA018 | ● F021A3MA018 | ● F021A4MA018 |
| ● F021A2MA030 | ● F021A3MA030 | ● F021A4MA030 |
| ● F021A2MA033 | ● F021A3MA033 | ● F021A4MA033 |

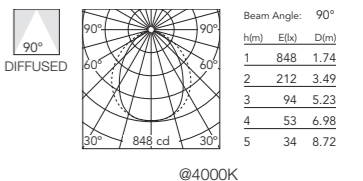

²Quick Install I H2O Stop Fast Connect - Schema elettrico n.8 page 461 / Wiring diagram n.8 page 461

- | | | |
|---------------|---------------|---------------|
| 2700K | 3000K | 4000K |
| ○ F021B2MA001 | ○ F021B3MA001 | ○ F021B4MA001 |
| ● F021B2MA006 | ● F021B3MA006 | ● F021B4MA006 |
| ● F021B2MA012 | ● F021B3MA012 | ● F021B4MA012 |
| ● F021B2MA018 | ● F021B3MA018 | ● F021B4MA018 |
| ● F021B2MA030 | ● F021B3MA030 | ● F021B4MA030 |
| ● F021B2MA033 | ● F021B3MA033 | ● F021B4MA033 |

³Continuous Line I/O H2O Stop Fast Connect - Schema elettrico n.9 page 461 / Wiring diagram n.9 page 461

- | | | |
|---------------|---------------|---------------|
| 2700K | 3000K | 4000K |
| ○ F021C2MA001 | ○ F021C3MA001 | ○ F021C4MA001 |
| ● F021C2MA006 | ● F021C3MA006 | ● F021C4MA006 |
| ● F021C2MA012 | ● F021C3MA012 | ● F021C4MA012 |
| ● F021C2MA018 | ● F021C3MA018 | ● F021C4MA018 |
| ● F021C2MA030 | ● F021C3MA030 | ● F021C4MA030 |
| ● F021C2MA033 | ● F021C3MA033 | ● F021C4MA033 |

Outgraze 50 L 600 - Dimmable DALI

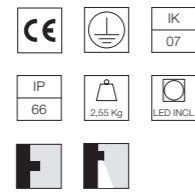
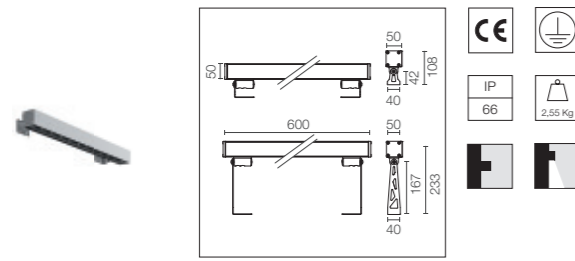

Alimentazione elettrica 120/240V integrata. Staffe di installazione da ordinare separatamente. Vetro trasparente extra chiaro, esclusa versione DIFFUSED con vetro sabbato. A richiesta versione SMART dimmerabile DALI (potenza 7W - flusso -50% lm). A richiesta versione dimmerabile 1-10V.

Integrated 120/240V power supply. Installation brackets, to be ordered separately. Extra clear transparent glass, excluding the DIFFUSE version with sandblasted glass. SMART dimmable DALI version available upon request (power 7W - flux -50% lm). 1-10V dimmable version upon request.

Power Led: 14,5W - 1669 lm ≠ *FIXT 1369 lm - 2700K/CRI 80 - 120-240V / 14,5W - 1729 lm ≠ *FIXT 1418 lm - 3000K/CRI 80 - 120-240V / 14,5W - 1788 lm ≠ *FIXT 1467 lm - 4000K/CRI 80 -120-240V / *FIXT lm = Medium Optic

Quick Install I H2O Stop Fast Connect - Schema elettrico n.10 page 462 / Wiring diagram n.10 page 462

- | | | |
|---------------|---------------|---------------|
| 2700K | 3000K | 4000K |
| ○ F021B22D001 | ○ F021B32D001 | ○ F021B42D001 |
| ● F021B22D006 | ● F021B32D006 | ● F021B42D006 |
| ● F021B22D012 | ● F021B32D012 | ● F021B42D012 |
| ● F021B22D018 | ● F021B32D018 | ● F021B42D018 |
| ● F021B22D030 | ● F021B32D030 | ● F021B42D030 |
| ● F021B22D033 | ● F021B32D033 | ● F021B42D033 |

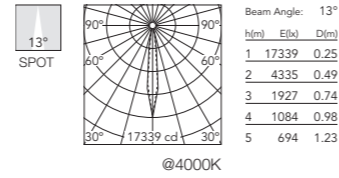

Continuous Line I/O H2O Stop Fast Connect - Schema elettrico n.11 page 462 / Wiring diagram n.11 page 462

- | | | |
|---------------|---------------|---------------|
| 2700K | 3000K | 4000K |
| ○ F021C22D001 | ○ F021C32D001 | ○ F021C42D001 |
| ● F021C22D006 | ● F021C32D006 | ● F021C42D006 |
| ● F021C22D012 | ● F021C32D012 | ● F021C42D012 |
| ● F021C22D018 | ● F021C32D018 | ● F021C42D018 |
| ● F021C22D030 | ● F021C32D030 | ● F021C42D030 |
| ● F021C22D033 | ● F021C32D033 | ● F021C42D033 |

Quick Install I H2O Stop Fast Connect - Schema elettrico n.10 page 462 / Wiring diagram n.10 page 462

- | | | |
|---------------|---------------|---------------|
| 2700K | 3000K | 4000K |
| ○ F021B26D001 | ○ F021B36D001 | ○ F021B46D001 |
| ● F021B26D006 | ● F021B36D006 | ● F021B46D006 |
| ● F021B26D012 | ● F021B36D012 | ● F021B46D012 |
| ● F021B26D018 | ● F021B36D018 | ● F021B46D018 |
| ● F021B26D030 | ● F021B36D030 | ● F021B46D030 |
| ● F021B26D033 | ● F021B36D033 | ● F021B46D033 |

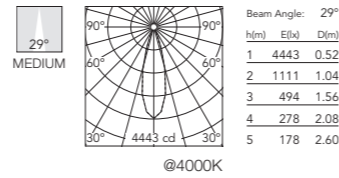

Continuous Line I/O H2O Stop Fast Connect - Schema elettrico n.11 page 462 / Wiring diagram n.11 page 462

- | | | |
|---------------|---------------|---------------|
| 2700K | 3000K | 4000K |
| ○ F021C26D001 | ○ F021C36D001 | ○ F021C46D001 |
| ● F021C26D006 | ● F021C36D006 | ● F021C46D006 |
| ● F021C26D012 | ● F021C36D012 | ● F021C46D012 |
| ● F021C26D018 | ● F021C36D018 | ● F021C46D018 |
| ● F021C26D030 | ● F021C36D030 | ● F021C46D030 |
| ● F021C26D033 | ● F021C36D033 | ● F021C46D033 |

Quick Install I H2O Stop Fast Connect - Schema elettrico n.10 page 462 / Wiring diagram n.10 page 462

- | | | |
|---------------|---------------|---------------|
| 2700K | 3000K | 4000K |
| ○ F021B2BD001 | ○ F021B3BD001 | ○ F021B4BD001 |
| ● F021B2BD006 | ● F021B3BD006 | ● F021B4BD006 |
| ● F021B2BD012 | ● F021B3BD012 | ● F021B4BD012 |
| ● F021B2BD018 | ● F021B3BD018 | ● F021B4BD018 |
| ● F021B2BD030 | ● F021B3BD030 | ● F021B4BD030 |
| ● F021B2BD033 | ● F021B3BD033 | ● F021B4BD033 |

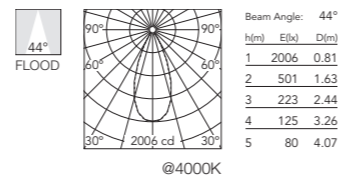

Continuous Line I/O H2O Stop Fast Connect - Schema elettrico n.11 page 462 / Wiring diagram n.11 page 462

- | | | |
|---------------|---------------|---------------|
| 2700K | 3000K | 4000K |
| ○ F021C2BD001 | ○ F021C3BD001 | ○ F021C4BD001 |
| ● F021C2BD006 | ● F021C3BD006 | ● F021C4BD006 |
| ● F021C2BD012 | ● F021C3BD012 | ● F021C4BD012 |
| ● F021C2BD018 | ● F021C3BD018 | ● F021C4BD018 |
| ● F021C2BD030 | ● F021C3BD030 | ● F021C4BD030 |
| ● F021C2BD033 | ● F021C3BD033 | ● F021C4BD033 |

Quick Install I H2O Stop Fast Connect - Schema elettrico n.10 page 462 / Wiring diagram n.10 page 462

- | | | |
|---------------|---------------|---------------|
| 2700K | 3000K | 4000K |
| ○ F021B2FD001 | ○ F021B3FD001 | ○ F021B4FD001 |
| ● F021B2FD006 | ● F021B3FD006 | ● F021B4FD006 |
| ● F021B2FD012 | ● F021B3FD012 | ● F021B4FD012 |
| ● F021B2FD018 | ● F021B3FD018 | ● F021B4FD018 |
| ● F021B2FD030 | ● F021B3FD030 | ● F021B4FD030 |
| ● F021B2FD033 | ● F021B3FD033 | ● F021B4FD033 |

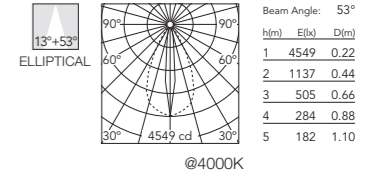

Continuous Line I/O H2O Stop Fast Connect - Schema elettrico n.11 page 462 / Wiring diagram n.11 page 462

- | | | |
|---------------|---------------|---------------|
| 2700K | 3000K | 4000K |
| ○ F021C2FD001 | ○ F021C3FD001 | ○ F021C4FD001 |
| ● F021C2FD006 | ● F021C3FD006 | ● F021C4FD006 |
| ● F021C2FD012 | ● F021C3FD012 | ● F021C4FD012 |
| ● F021C2FD018 | ● F021C3FD018 | ● F021C4FD018 |
| ● F021C2FD030 | ● F021C3FD030 | ● F021C4FD030 |
| ● F021C2FD033 | ● F021C3FD033 | ● F021C4FD033 |

Quick Install I H2O Stop Fast Connect - Schema elettrico n.10 page 462 / Wiring diagram n.10 page 462

- | | | |
|---------------|---------------|---------------|
| 2700K | 3000K | 4000K |
| ○ F021B2KD001 | ○ F021B3KD001 | ○ F021B4KD001 |
| ● F021B2KD006 | ● F021B3KD006 | ● F021B4KD006 |
| ● F021B2KD012 | ● F021B3KD012 | ● F021B4KD012 |
| ● F021B2KD018 | ● F021B3KD018 | ● F021B4KD018 |
| ● F021B2KD030 | ● F021B3KD030 | ● F021B4KD030 |
| ● F021B2KD033 | ● F021B3KD033 | ● F021B4KD033 |

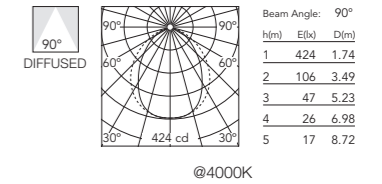

Continuous Line I/O H2O Stop Fast Connect - Schema elettrico n.11 page 462 / Wiring diagram n.11 page 462

- | | | |
|---------------|---------------|---------------|
| 2700K | 3000K | 4000K |
| ○ F021C2KD001 | ○ F021C3KD001 | ○ F021C4KD001 |
| ● F021C2KD006 | ● F021C3KD006 | ● F021C4KD006 |
| ● F021C2KD012 | ● F021C3KD012 | ● F021C4KD012 |
| ● F021C2KD018 | ● F021C3KD018 | ● F021C4KD018 |
| ● F021C2KD030 | ● F021C3KD030 | ● F021C4KD030 |
| ● F021C2KD033 | ● F021C3KD033 | ● F021C4KD033 |

²Quick Install In H2O Stop Version: connettore H2O Stop Plug&Play preinstallato per connessione rapida (accessori per collegamento da ordinare) / Prewired H2O Stop Plug&Play connector for an easy/rapid connection (connecting accessory to be ordered separately).

³Continuous Line In/Out H2O Stop Version: connettori H2O Stop Plug&Play preinstallati per connessione in linea (accessori per collegamento da ordinare) / Prewired H2O Stop Plug&Play connectors for an easy in line connection (connecting accessory to be ordered separately).

Outgraze 50 L 900 - Dimmable DALI

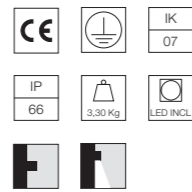
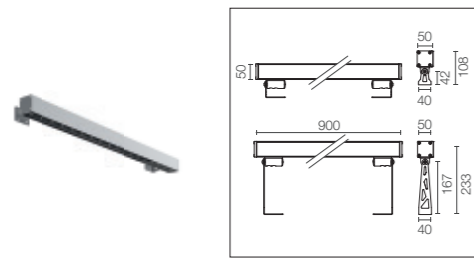

Alimentazione elettrica 120/240V integrata. Staffe di installazione da ordinare separatamente. Vetro trasparente extra chiaro, esclusa versione DIFFUSED con vetro sabbato. A richiesta versione SMART dimmerabile DALI (potenza 11W - flusso -50% lm). A richiesta versione dimmerabile 1-10V.

Integrated 120/240V power supply. Installation brackets, to be ordered separately. Extra clear transparent glass, excluding the DIFFUSE version with sandblasted glass. SMART dimmable DALI version available upon request (power 11W - flux -50% lm). 1-10V dimmable version upon request.

Power Led: 20W - 2504 lm ≠ *FIXT 2054 lm - 2700K/CRI 80 - 120-240V / 20W - 2593 lm ≠ *FIXT 2127 lm - 3000K/CRI 80 - 120-240V / 20W - 2683 lm ≠ *FIXT 2201 lm - 4000K/CRI 80 -120-240V / *FIXT lm = Medium Optic

2Quick Install I H2O Stop Fast Connect - Schema elettrico n.10 page 462 / Wiring diagram n.10 page 462

- | | | |
|---------------|---------------|---------------|
| 2700K | 3000K | 4000K |
| ○ F021B23D001 | ○ F021B33D001 | ○ F021B43D001 |
| ● F021B23D006 | ● F021B33D006 | ● F021B43D006 |
| ● F021B23D012 | ● F021B33D012 | ● F021B43D012 |
| ● F021B23D018 | ● F021B33D018 | ● F021B43D018 |
| ● F021B23D030 | ● F021B33D030 | ● F021B43D030 |
| ● F021B23D033 | ● F021B33D033 | ● F021B43D033 |

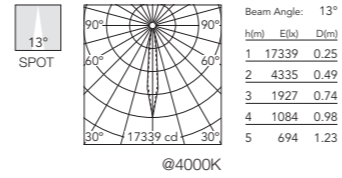

3Continuous Line I/O H2O Stop Fast Connect - Schema elettrico n.11 page 462 / Wiring diagram n.11 page 462

- | | | |
|---------------|---------------|---------------|
| 2700K | 3000K | 4000K |
| ○ F021C23D001 | ○ F021C33D001 | ○ F021C43D001 |
| ● F021C23D006 | ● F021C33D006 | ● F021C43D006 |
| ● F021C23D012 | ● F021C33D012 | ● F021C43D012 |
| ● F021C23D018 | ● F021C33D018 | ● F021C43D018 |
| ● F021C23D030 | ● F021C33D030 | ● F021C43D030 |
| ● F021C23D033 | ● F021C33D033 | ● F021C43D033 |

2Quick Install I H2O Stop Fast Connect - Schema elettrico n.10 page 462 / Wiring diagram n.10 page 462

- | | | |
|---------------|---------------|---------------|
| 2700K | 3000K | 4000K |
| ○ F021B27D001 | ○ F021B37D001 | ○ F021B47D001 |
| ● F021B27D006 | ● F021B37D006 | ● F021B47D006 |
| ● F021B27D012 | ● F021B37D012 | ● F021B47D012 |
| ● F021B27D018 | ● F021B37D018 | ● F021B47D018 |
| ● F021B27D030 | ● F021B37D030 | ● F021B47D030 |
| ● F021B27D033 | ● F021B37D033 | ● F021B47D033 |

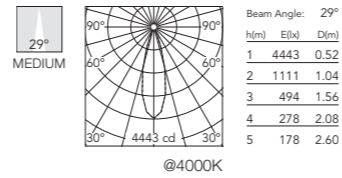

3Continuous Line I/O H2O Stop Fast Connect - Schema elettrico n.11 page 462 / Wiring diagram n.11 page 462

- | | | |
|---------------|---------------|---------------|
| 2700K | 3000K | 4000K |
| ○ F021C27D001 | ○ F021C37D001 | ○ F021C47D001 |
| ● F021C27D006 | ● F021C37D006 | ● F021C47D006 |
| ● F021C27D012 | ● F021C37D012 | ● F021C47D012 |
| ● F021C27D018 | ● F021C37D018 | ● F021C47D018 |
| ● F021C27D030 | ● F021C37D030 | ● F021C47D030 |
| ● F021C27D033 | ● F021C37D033 | ● F021C47D033 |

2Quick Install I H2O Stop Fast Connect - Schema elettrico n.10 page 462 / Wiring diagram n.10 page 462

- | | | |
|---------------|---------------|---------------|
| 2700K | 3000K | 4000K |
| ○ F021B2CD001 | ○ F021B3CD001 | ○ F021B4CD001 |
| ● F021B2CD006 | ● F021B3CD006 | ● F021B4CD006 |
| ● F021B2CD012 | ● F021B3CD012 | ● F021B4CD012 |
| ● F021B2CD018 | ● F021B3CD018 | ● F021B4CD018 |
| ● F021B2CD030 | ● F021B3CD030 | ● F021B4CD030 |
| ● F021B2CD033 | ● F021B3CD033 | ● F021B4CD033 |

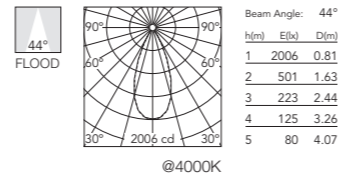

3Continuous Line I/O H2O Stop Fast Connect - Schema elettrico n.11 page 462 / Wiring diagram n.11 page 462

- | | | |
|---------------|---------------|---------------|
| 2700K | 3000K | 4000K |
| ○ F021C2CD001 | ○ F021C3CD001 | ○ F021C4CD001 |
| ● F021C2CD006 | ● F021C3CD006 | ● F021C4CD006 |
| ● F021C2CD012 | ● F021C3CD012 | ● F021C4CD012 |
| ● F021C2CD018 | ● F021C3CD018 | ● F021C4CD018 |
| ● F021C2CD030 | ● F021C3CD030 | ● F021C4CD030 |
| ● F021C2CD033 | ● F021C3CD033 | ● F021C4CD033 |

2Quick Install I H2O Stop Fast Connect - Schema elettrico n.10 page 462 / Wiring diagram n.10 page 462

- | | | |
|---------------|---------------|---------------|
| 2700K | 3000K | 4000K |
| ○ F021B2GD001 | ○ F021B3GD001 | ○ F021B4GD001 |
| ● F021B2GD006 | ● F021B3GD006 | ● F021B4GD006 |
| ● F021B2GD012 | ● F021B3GD012 | ● F021B4GD012 |
| ● F021B2GD018 | ● F021B3GD018 | ● F021B4GD018 |
| ● F021B2GD030 | ● F021B3GD030 | ● F021B4GD030 |
| ● F021B2GD033 | ● F021B3GD033 | ● F021B4GD033 |

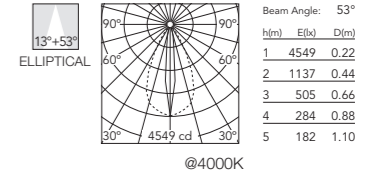

3Continuous Line I/O H2O Stop Fast Connect - Schema elettrico n.11 page 462 / Wiring diagram n.11 page 462

- | | | |
|---------------|---------------|---------------|
| 2700K | 3000K | 4000K |
| ○ F021C2GD001 | ○ F021C3GD001 | ○ F021C4GD001 |
| ● F021C2GD006 | ● F021C3GD006 | ● F021C4GD006 |
| ● F021C2GD012 | ● F021C3GD012 | ● F021C4GD012 |
| ● F021C2GD018 | ● F021C3GD018 | ● F021C4GD018 |
| ● F021C2GD030 | ● F021C3GD030 | ● F021C4GD030 |
| ● F021C2GD033 | ● F021C3GD033 | ● F021C4GD033 |

2Quick Install I H2O Stop Fast Connect - Schema elettrico n.10 page 462 / Wiring diagram n.10 page 462

- | | | |
|---------------|---------------|---------------|
| 2700K | 3000K | 4000K |
| ○ F021B2LD001 | ○ F021B3LD001 | ○ F021B4LD001 |
| ● F021B2LD006 | ● F021B3LD006 | ● F021B4LD006 |
| ● F021B2LD012 | ● F021B3LD012 | ● F021B4LD012 |
| ● F021B2LD018 | ● F021B3LD018 | ● F021B4LD018 |
| ● F021B2LD030 | ● F021B3LD030 | ● F021B4LD030 |
| ● F021B2LD033 | ● F021B3LD033 | ● F021B4LD033 |

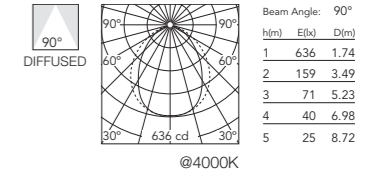

3Continuous Line I/O H2O Stop Fast Connect - Schema elettrico n.11 page 462 / Wiring diagram n.11 page 462

- | | | |
|---------------|---------------|---------------|
| 2700K | 3000K | 4000K |
| ○ F021C2LD001 | ○ F021C3LD001 | ○ F021C4LD001 |
| ● F021C2LD006 | ● F021C3LD006 | ● F021C4LD006 |
| ● F021C2LD012 | ● F021C3LD012 | ● F021C4LD012 |
| ● F021C2LD018 | ● F021C3LD018 | ● F021C4LD018 |
| ● F021C2LD030 | ● F021C3LD030 | ● F021C4LD030 |
| ● F021C2LD033 | ● F021C3LD033 | ● F021C4LD033 |

²Quick Install In H2O Stop Version: connettore H2O Stop Plug&Play preinstallato per connessione rapida (accessori per collegamento da ordinare) / Prewired H2O Stop Plug&Play connector for an easy/rapid connection (connecting accessory to be ordered separately).

³Continuous Line In/Out H2O Stop Version: connettori H2O Stop Plug&Play preinstallati per connessione in linea (accessori per collegamento da ordinare) / Prewired H2O Stop Plug&Play connectors for an easy in line connection (connecting accessory to be ordered separately).

Outgraze 50 L 1200 - Dimmable DALI

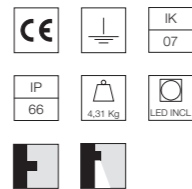
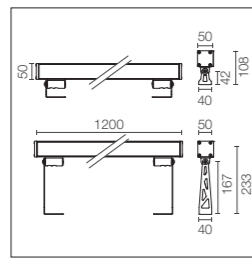

Alimentazione elettrica 120/240V integrata. Staffe di installazione da ordinare separatamente. Vetro trasparente extra chiaro, esclusa versione DIFFUSED con vetro sabbato. A richiesta versione SMART dimmerabile DALI (potenza 14W - flusso -50% lm). A richiesta versione dimmerabile 1-10V.

Integrated 120/240V power supply. Installation brackets, to be ordered separately. Extra clear transparent glass, excluding the DIFFUSE version with sandblasted glass. SMART dimmable DALI version available upon request (power 14W - flux -50% lm). 1-10V dimmable version upon request.

Power Led: 27W - 3338 lm ≠ *FIXT 2739 lm - 2700K/CRI 80 - 120-240V / 27W - 3458 lm ≠ *FIXT 2836 lm - 3000K/CRI 80 - 120-240 / 27W - 3577 lm ≠ *FIXT 2934 lm - 4000K/CRI 80 -120-240V
*FIXT lm = Medium Optic

2Quick Install I H2O Stop Fast Connect - Schema elettrico n.10 page 462 / Wiring diagram n.10 page 462

- | | | |
|---------------|---------------|---------------|
| 2700K | 3000K | 4000K |
| ○ F021B24D001 | ○ F021B34D001 | ○ F021B44D001 |
| ● F021B24D006 | ● F021B34D006 | ● F021B44D006 |
| ● F021B24D012 | ● F021B34D012 | ● F021B44D012 |
| ● F021B24D018 | ● F021B34D018 | ● F021B44D018 |
| ● F021B24D030 | ● F021B34D030 | ● F021B44D030 |
| ● F021B24D033 | ● F021B34D033 | ● F021B44D033 |

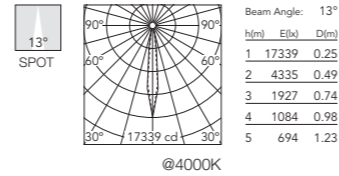

3Continuous Line I/O H2O Stop Fast Connect - Schema elettrico n.11 page 462 / Wiring diagram n.11 page 462

- | | | |
|---------------|---------------|---------------|
| 2700K | 3000K | 4000K |
| ○ F021C24D001 | ○ F021C34D001 | ○ F021C44D001 |
| ● F021C24D006 | ● F021C34D006 | ● F021C44D006 |
| ● F021C24D012 | ● F021C34D012 | ● F021C44D012 |
| ● F021C24D018 | ● F021C34D018 | ● F021C44D018 |
| ● F021C24D030 | ● F021C34D030 | ● F021C44D030 |
| ● F021C24D033 | ● F021C34D033 | ● F021C44D033 |

2Quick Install I H2O Stop Fast Connect - Schema elettrico n.10 page 462 / Wiring diagram n.10 page 462

- | | | |
|---------------|---------------|---------------|
| 2700K | 3000K | 4000K |
| ○ F021B28D001 | ○ F021B38D001 | ○ F021B48D001 |
| ● F021B28D006 | ● F021B38D006 | ● F021B48D006 |
| ● F021B28D012 | ● F021B38D012 | ● F021B48D012 |
| ● F021B28D018 | ● F021B38D018 | ● F021B48D018 |
| ● F021B28D030 | ● F021B38D030 | ● F021B48D030 |
| ● F021B28D033 | ● F021B38D033 | ● F021B48D033 |

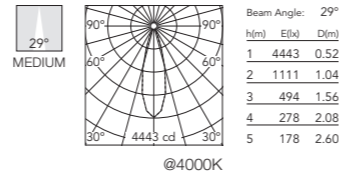

3Continuous Line I/O H2O Stop Fast Connect - Schema elettrico n.11 page 462 / Wiring diagram n.11 page 462

- | | | |
|---------------|---------------|---------------|
| 2700K | 3000K | 4000K |
| ○ F021C28D001 | ○ F021C38D001 | ○ F021C48D001 |
| ● F021C28D006 | ● F021C38D006 | ● F021C48D006 |
| ● F021C28D012 | ● F021C38D012 | ● F021C48D012 |
| ● F021C28D018 | ● F021C38D018 | ● F021C48D018 |
| ● F021C28D030 | ● F021C38D030 | ● F021C48D030 |
| ● F021C28D033 | ● F021C38D033 | ● F021C48D033 |

2Quick Install I H2O Stop Fast Connect - Schema elettrico n.10 page 462 / Wiring diagram n.10 page 462

- | | | |
|---------------|---------------|---------------|
| 2700K | 3000K | 4000K |
| ○ F021B2DD001 | ○ F021B3DD001 | ○ F021B4DD001 |
| ● F021B2DD006 | ● F021B3DD006 | ● F021B4DD006 |
| ● F021B2DD012 | ● F021B3DD012 | ● F021B4DD012 |
| ● F021B2DD018 | ● F021B3DD018 | ● F021B4DD018 |
| ● F021B2DD030 | ● F021B3DD030 | ● F021B4DD030 |
| ● F021B2DD033 | ● F021B3DD033 | ● F021B4DD033 |

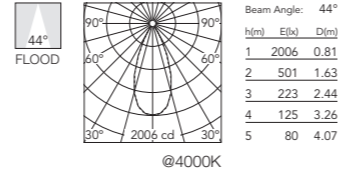

3Continuous Line I/O H2O Stop Fast Connect - Schema elettrico n.11 page 462 / Wiring diagram n.11 page 462

- | | | |
|---------------|---------------|---------------|
| 2700K | 3000K | 4000K |
| ○ F021C2DD001 | ○ F021C3DD001 | ○ F021C4DD001 |
| ● F021C2DD006 | ● F021C3DD006 | ● F021C4DD006 |
| ● F021C2DD012 | ● F021C3DD012 | ● F021C4DD012 |
| ● F021C2DD018 | ● F021C3DD018 | ● F021C4DD018 |
| ● F021C2DD030 | ● F021C3DD030 | ● F021C4DD030 |
| ● F021C2DD033 | ● F021C3DD033 | ● F021C4DD033 |

2Quick Install I H2O Stop Fast Connect - Schema elettrico n.10 page 462 / Wiring diagram n.10 page 462

- | | | |
|---------------|---------------|---------------|
| 2700K | 3000K | 4000K |
| ○ F021B2HD001 | ○ F021B3HD001 | ○ F021B4HD001 |
| ● F021B2HD006 | ● F021B3HD006 | ● F021B4HD006 |
| ● F021B2HD012 | ● F021B3HD012 | ● F021B4HD012 |
| ● F021B2HD018 | ● F021B3HD018 | ● F021B4HD018 |
| ● F021B2HD030 | ● F021B3HD030 | ● F021B4HD030 |
| ● F021B2HD033 | ● F021B3HD033 | ● F021B4HD033 |

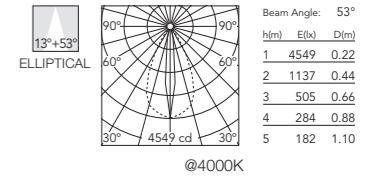

3Continuous Line I/O H2O Stop Fast Connect - Schema elettrico n.11 page 462 / Wiring diagram n.11 page 462

- | | | |
|---------------|---------------|---------------|
| 2700K | 3000K | 4000K |
| ○ F021C2HD001 | ○ F021C3HD001 | ○ F021C4HD001 |
| ● F021C2HD006 | ● F021C3HD006 | ● F021C4HD006 |
| ● F021C2HD012 | ● F021C3HD012 | ● F021C4HD012 |
| ● F021C2HD018 | ● F021C3HD018 | ● F021C4HD018 |
| ● F021C2HD030 | ● F021C3HD030 | ● F021C4HD030 |
| ● F021C2HD033 | ● F021C3HD033 | ● F021C4HD033 |

2Quick Install I H2O Stop Fast Connect - Schema elettrico n.10 page 462 / Wiring diagram n.10 page 462

- | | | |
|---------------|---------------|---------------|
| 2700K | 3000K | 4000K |
| ○ F021B2MD001 | ○ F021B3MD001 | ○ F021B4MD001 |
| ● F021B2MD006 | ● F021B3MD006 | ● F021B4MD006 |
| ● F021B2MD012 | ● F021B3MD012 | ● F021B4MD012 |
| ● F021B2MD018 | ● F021B3MD018 | ● F021B4MD018 |
| ● F021B2MD030 | ● F021B3MD030 | ● F021B4MD030 |
| ● F021B2MD033 | ● F021B3MD033 | ● F021B4MD033 |

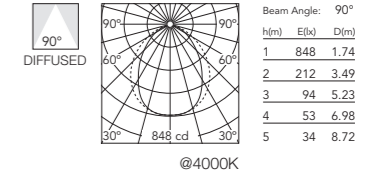

3Continuous Line I/O H2O Stop Fast Connect - Schema elettrico n.11 page 462 / Wiring diagram n.11 page 462

- | | | |
|---------------|---------------|---------------|
| 2700K | 3000K | 4000K |
| ○ F021C2MD001 | ○ F021C3MD001 | ○ F021C4MD001 |
| ● F021C2MD006 | ● F021C3MD006 | ● F021C4MD006 |
| ● F021C2MD012 | ● F021C3MD012 | ● F021C4MD012 |
| ● F021C2MD018 | ● F021C3MD018 | ● F021C4MD018 |
| ● F021C2MD030 | ● F021C3MD030 | ● F021C4MD030 |
| ● F021C2MD033 | ● F021C3MD033 | ● F021C4MD033 |

²Quick Install In H2O Stop Version: connettore H2O Stop Plug&Play preinstallato per connessione rapida (accessori per collegamento da ordinare) / Prewired H2O Stop Plug&Play connector for an easy/rapid connection (connecting accessory to be ordered separately).

³Continuous Line In/Out H2O Stop Version: connettori H2O Stop Plug&Play preinstallati per connessione in linea (accessori per collegamento da ordinare) / Prewired H2O Stop Plug&Play connectors for an easy in line connection (connecting accessory to be ordered separately).

Outgraze 50 - RGB

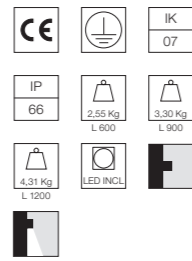
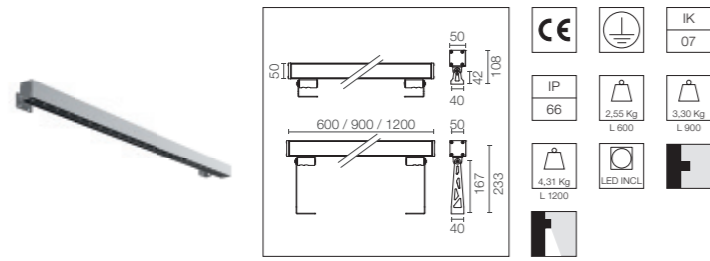

Alimentazione elettrica 120/240V e interfaccia DMX-RDM integrata. Staffe di installazione da ordinare separatamente. Vetro sabbato.

Intergrated 120/240V power supply and DMX-RDM interface. Installation brackets, to be ordered separately. Sandblasted glass.

Power Led: L600: 26W - 120-240V - DMX-RDM interface / L900: 37W - 120-240V - DMX-RDM interface / L1200: 48W - 120-240V - DMX-RDM interface

Schema elettrico n.12 page 462 / Wiring diagram n.12 page 462

- | | | |
|---------------|---------------|---------------|
| L 600 | L 900 | L 1200 |
| ○ F021MRKJ001 | ○ F021MRLJ001 | ○ F021MRMJ001 |
| ● F021MRKJ006 | ● F021MRLJ006 | ● F021MRMJ006 |
| ● F021MRKJ012 | ● F021MRLJ012 | ● F021MRMJ012 |
| ● F021MRKJ018 | ● F021MRLJ018 | ● F021MRMJ018 |
| ● F021MRKJ030 | ● F021MRLJ030 | ● F021MRMJ030 |
| ● F021MRKJ033 | ● F021MRLJ033 | ● F021MRMJ033 |



Photometric data on request.

Outgraze 50 - RGBW

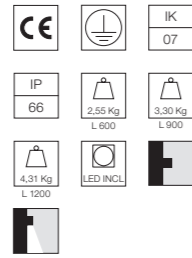
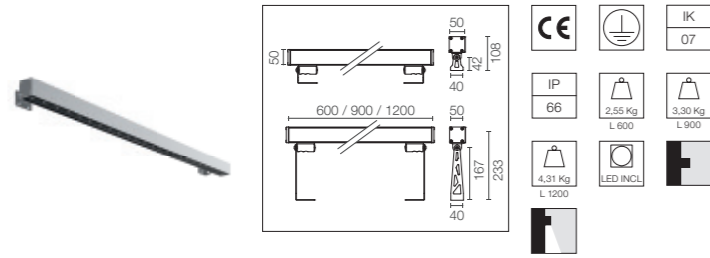

Alimentazione elettrica 120/240V e interfaccia DMX-RDM integrata. Staffe di installazione da ordinare separatamente. Vetro sabbato.

Intergrated 120/240V power supply and DMX-RDM interface. Installation brackets, to be ordered separately. Sandblasted glass.

Power Led: L600: 24W - 120-240V - DMX-RDM interface / L900: 33W - 120-240V - DMX-RDM interface / L1200: 43W 120-240V - DMX-RDM interface

Schema elettrico n.12 page 462 / Wiring diagram n.12 page 462

- | | | |
|---------------|---------------|---------------|
| L 600 | L 900 | L 1200 |
| ○ F021MWKJ001 | ○ F021MWLJ001 | ○ F021MWMJ001 |
| ● F021MWKJ006 | ● F021MWLJ006 | ● F021MWMJ006 |
| ● F021MWKJ012 | ● F021MWLJ012 | ● F021MWMJ012 |
| ● F021MWKJ018 | ● F021MWLJ018 | ● F021MWMJ018 |
| ● F021MWKJ030 | ● F021MWLJ030 | ● F021MWMJ030 |
| ● F021MWKJ033 | ● F021MWLJ033 | ● F021MWMJ033 |



Photometric data on request.

Outgraze 50 - Tunable White DALI 2700K÷5700K

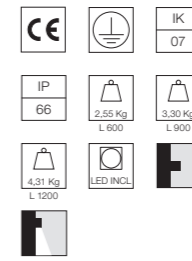
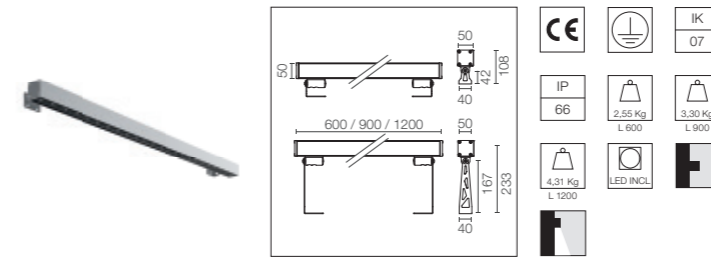

Alimentazione elettrica 120/240V DALI integrata. Staffe di installazione da ordinare separatamente. Vetro sabbato.

120/240V DALI intergrated power supply. Installation brackets, to be ordered separately. Sandblasted glass.

Power Led: L600: 13W - 1413 lm ≠ FIXT 722 lm - 2700K/CRI 80 - 120-240V / L900: 18,5W - 1669 lm ≠ FIXT 1082 lm - 2700K/CRI 80 - 120-240V / L1200: 23W - 2826 lm ≠ FIXT 1443 lm - 2700K/CRI 80 - 120-240V

²Quick Install I H2O Stop Fast Connect - Schema elettrico n.10 page 462 / Wiring diagram n.10 page 462

- L 600**
- F021PTKD001
 - F021PTKD006
 - F021PTKD012
 - F021PTKD018
 - F021PTKD030
 - F021PTKD033

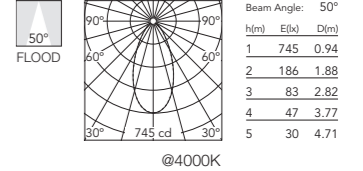

³Continuous Line I/O H2O Stop Fast Connect - Schema elettrico n.11 page 462 / Wiring diagram n.11 page 462

- L 600**
- F021QTKD001
 - F021QTKD006
 - F021QTKD012
 - F021QTKD018
 - F021QTKD030
 - F021QTKD033

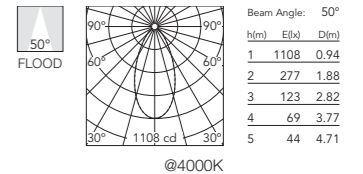

²Quick Install I H2O Stop Fast Connect - Schema elettrico n.10 page 462 / Wiring diagram n.10 page 462

- L 900**
- F021PTLD001
 - F021PTLD006
 - F021PTLD012
 - F021PTLD018
 - F021PTLD030
 - F021PTLD033

³Continuous Line I/O H2O Stop Fast Connect - Schema elettrico n.11 page 462 / Wiring diagram n.11 page 462

- L 900**
- F021QTLD001
 - F021QTLD006
 - F021QTLD012
 - F021QTLD018
 - F021QTLD030
 - F021QTLD033

²Quick Install I H2O Stop Fast Connect - Schema elettrico n.10 page 462 / Wiring diagram n.10 page 462

- L 1200**
- F021PTMD001
 - F021PTMD006
 - F021PTMD012
 - F021PTMD018
 - F021PTMD030
 - F021PTMD033

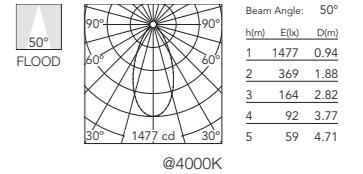

³Continuous Line I/O H2O Stop Fast Connect - Schema elettrico n.11 page 462 / Wiring diagram n.11 page 462

- L 1200**
- F021QTMD001
 - F021QTMD006
 - F021QTMD012
 - F021QTMD018
 - F021QTMD030
 - F021QTMD033

²Quick Install In H2O Stop Version: connettore H2O Stop Plug&Play preinstallato per connessione rapida (accessori per collegamento da ordinare) / Prewired H2O Stop Plug&Play connector for an easy/rapid connection (connecting accessory to be ordered separately).

³Continuous Line In/Out H2O Stop Version: connettori H2O Stop Plug&Play preinstallati per connessione in linea (accessori per collegamento da ordinare) / Prewired H2O Stop Plug&Play connectors for an easy in line connection (connecting accessory to be ordered separately).

Outgraze 50 Easy L 300 - Non Dimmable

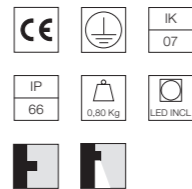
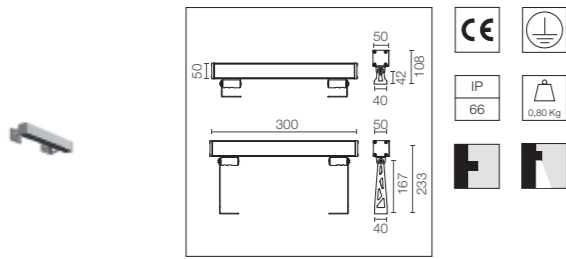

Alimentazione elettrica 220/240V integrata. Staffe di installazione da ordinare separatamente. Vetro sabbato.

Integrated 220/240V power supply. Installation brackets, to be ordered separately. Sandblasted glass.

Mid-power Led: 8W - 806 lm ≠ FIXT 310 lm - 2700K/CRI 80 - 220-240V / 8W - 876 lm ≠ FIXT 337 lm - 3000K/CRI 80 - 220-240V / 8W - 946 lm ≠ FIXT 364 lm - 4000K/CRI 80 - 220-240V

¹Standard - Schema elettrico n.7 page 461 / Wiring diagram n.7 page 461

- | | | |
|---------------|---------------|---------------|
| 2700K | 3000K | 4000K |
| ○ F021G2JA001 | ○ F021G3JA001 | ○ F021G4JA001 |
| ● F021G2JA006 | ● F021G3JA006 | ● F021G4JA006 |
| ● F021G2JA012 | ● F021G3JA012 | ● F021G4JA012 |
| ● F021G2JA018 | ● F021G3JA018 | ● F021G4JA018 |
| ● F021G2JA030 | ● F021G3JA030 | ● F021G4JA030 |
| ● F021G2JA033 | ● F021G3JA033 | ● F021G4JA033 |

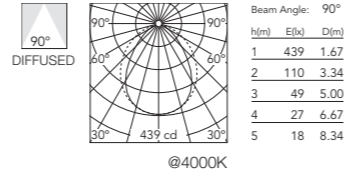

²Quick Install I H2O Stop Fast Connect - Schema elettrico n.8 page 461 / Wiring diagram n.8 page 461

- | | | |
|---------------|---------------|---------------|
| 2700K | 3000K | 4000K |
| ○ F021H2JA001 | ○ F021H3JA001 | ○ F021H4JA001 |
| ● F021H2JA006 | ● F021H3JA006 | ● F021H4JA006 |
| ● F021H2JA012 | ● F021H3JA012 | ● F021H4JA012 |
| ● F021H2JA018 | ● F021H3JA018 | ● F021H4JA018 |
| ● F021H2JA030 | ● F021H3JA030 | ● F021H4JA030 |
| ● F021H2JA033 | ● F021H3JA033 | ● F021H4JA033 |

Outgraze 50 Easy L 600 - Non Dimmable

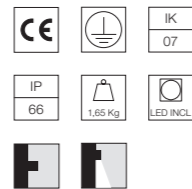
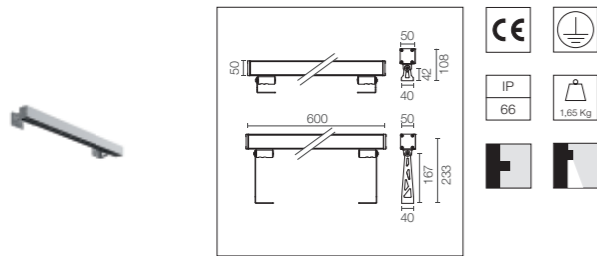

Alimentazione elettrica 220/240V integrata. Staffe di installazione da ordinare separatamente. Vetro sabbato.

Integrated 220/240V power supply. Installation brackets, to be ordered separately. Sandblasted glass.

Mid-power Led: 14,5W - 1612 lm ≠ FIXT 620 lm - 2700K/CRI 80 - 220-240V / 14,5W - 1752 lm ≠ FIXT 674 lm - 3000K/CRI 80 - 220-240V / 14,5W - 1892 lm ≠ FIXT 728 lm - 4000K/CRI 80 - 220-240V

¹Standard - Schema elettrico n.7 page 461 / Wiring diagram n.7 page 461

- | | | |
|---------------|---------------|---------------|
| 2700K | 3000K | 4000K |
| ○ F021G2KA001 | ○ F021G3KA001 | ○ F021G4KA001 |
| ● F021G2KA006 | ● F021G3KA006 | ● F021G4KA006 |
| ● F021G2KA012 | ● F021G3KA012 | ● F021G4KA012 |
| ● F021G2KA018 | ● F021G3KA018 | ● F021G4KA018 |
| ● F021G2KA030 | ● F021G3KA030 | ● F021G4KA030 |
| ● F021G2KA033 | ● F021G3KA033 | ● F021G4KA033 |

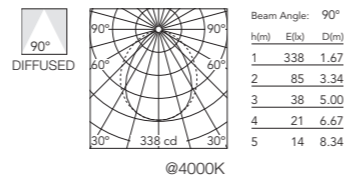

²Quick Install I H2O Stop Fast Connect - Schema elettrico n.8 page 461 / Wiring diagram n.8 page 461

- | | | |
|---------------|---------------|---------------|
| 2700K | 3000K | 4000K |
| ○ F021H2KA001 | ○ F021H3KA001 | ○ F021H4KA001 |
| ● F021H2KA006 | ● F021H3KA006 | ● F021H4KA006 |
| ● F021H2KA012 | ● F021H3KA012 | ● F021H4KA012 |
| ● F021H2KA018 | ● F021H3KA018 | ● F021H4KA018 |
| ● F021H2KA030 | ● F021H3KA030 | ● F021H4KA030 |
| ● F021H2KA033 | ● F021H3KA033 | ● F021H4KA033 |

³Continuous Line I/O H2O Stop Fast Connect - Schema elettrico n.9 page 461 / Wiring diagram n.9 page 461

- | | | |
|---------------|---------------|---------------|
| 2700K | 3000K | 4000K |
| ○ F021J2KA001 | ○ F021J3KA001 | ○ F021J4KA001 |
| ● F021J2KA006 | ● F021J3KA006 | ● F021J4KA006 |
| ● F021J2KA012 | ● F021J3KA012 | ● F021J4KA012 |
| ● F021J2KA018 | ● F021J3KA018 | ● F021J4KA018 |
| ● F021J2KA030 | ● F021J3KA030 | ● F021J4KA030 |
| ● F021J2KA033 | ● F021J3KA033 | ● F021J4KA033 |

¹Standard Version: spezzone di cavo in uscita 1000 mm (accessori per collegamento da ordinare) / 1000 mm length prewired cable (connecting accessory to be separately ordered).

²Quick Install In H2O Stop Version: connettore H2O Stop Plug&Play preinstallato per connessione rapida (accessori per collegamento da ordinare) / Prewired H2O Stop Plug&Play connector for an easy/rapid connection (connecting accessory to be ordered separately).

³Continuous Line In/Out H2O Stop Version: connettori H2O Stop Plug&Play preinstallati per connessione in linea (accessori per collegamento da ordinare) / Prewired H2O Stop Plug&Play connectors for an easy in line connection (connecting accessory to be ordered separately).

Outgraze 50 Easy L 900 - Non Dimmable

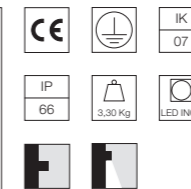
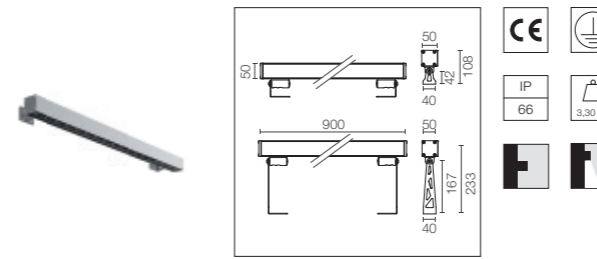

Alimentazione elettrica 220/240V integrata. Staffe di installazione da ordinare separatamente. Vetro sabbato.

Integrated 220/240V power supply. Installation brackets, to be ordered separately. Sandblasted glass.

Mid-power Led: 20W - 2418 lm ≠ FIXT 930 lm - 2700K/CRI 80 - 220-240V / 20W - 2628 lm ≠ FIXT 1011 lm - 3000K/CRI 80 - 220-240V / 20W - 2839 lm ≠ FIXT 1092 lm - 4000K/CRI 80 - 220-240V

¹Standard - Schema elettrico n.7 page 461 / Wiring diagram n.7 page 461

- | | | |
|---------------|---------------|---------------|
| 2700K | 3000K | 4000K |
| ○ F021G2LA001 | ○ F021G3LA001 | ○ F021G4LA001 |
| ● F021G2LA006 | ● F021G3LA006 | ● F021G4LA006 |
| ● F021G2LA012 | ● F021G3LA012 | ● F021G4LA012 |
| ● F021G2LA018 | ● F021G3LA018 | ● F021G4LA018 |
| ● F021G2LA030 | ● F021G3LA030 | ● F021G4LA030 |
| ● F021G2LA033 | ● F021G3LA033 | ● F021G4LA033 |

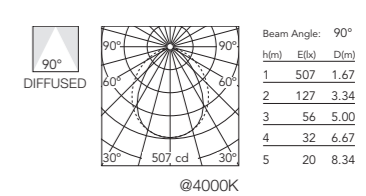

²Quick Install I H2O Stop Fast Connect - Schema elettrico n.8 page 461 / Wiring diagram n.8 page 461

- | | | |
|---------------|---------------|---------------|
| 2700K | 3000K | 4000K |
| ○ F021H2LA001 | ○ F021H3LA001 | ○ F021H4LA001 |
| ● F021H2LA006 | ● F021H3LA006 | ● F021H4LA006 |
| ● F021H2LA012 | ● F021H3LA012 | ● F021H4LA012 |
| ● F021H2LA018 | ● F021H3LA018 | ● F021H4LA018 |
| ● F021H2LA030 | ● F021H3LA030 | ● F021H4LA030 |
| ● F021H2LA033 | ● F021H3LA033 | ● F021H4LA033 |

³Continuous Line I/O H2O Stop Fast Connect - Schema elettrico n.9 page 461 / Wiring diagram n.9 page 461

- | | | |
|---------------|---------------|---------------|
| 2700K | 3000K | 4000K |
| ○ F021J2LA001 | ○ F021J3LA001 | ○ F021J4LA001 |
| ● F021J2LA006 | ● F021J3LA006 | ● F021J4LA006 |
| ● F021J2LA012 | ● F021J3LA012 | ● F021J4LA012 |
| ● F021J2LA018 | ● F021J3LA018 | ● F021J4LA018 |
| ● F021J2LA030 | ● F021J3LA030 | ● F021J4LA030 |
| ● F021J2LA033 | ● F021J3LA033 | ● F021J4LA033 |

Outgraze 50 Easy L 1200 - Non Dimmable

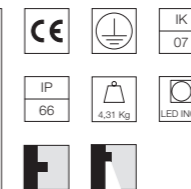
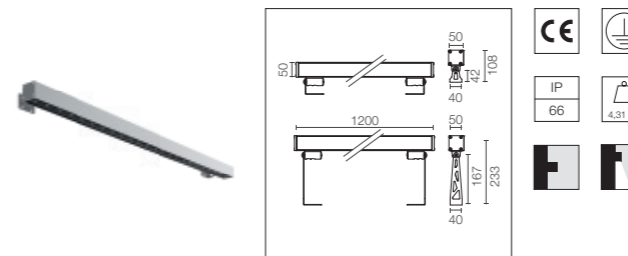

Alimentazione elettrica 220/240V integrata. Staffe di installazione da ordinare separatamente. Vetro sabbato.

Integrated 220/240V power supply. Installation brackets, to be ordered separately. Sandblasted glass.

Mid-power Led: 27W - 3224 lm ≠ FIXT 1240 lm - 2700K/CRI 80 - 220-240V / 27W - 3505 lm ≠ FIXT 1348 lm - 3000K/CRI 80 - 220-240V / 27W - 3785 lm ≠ FIXT 1456 lm - 4000K/CRI 80 - 220-240V

¹Standard - Schema elettrico n.7 page 461 / Wiring diagram n.7 page 461

- | | | |
|---------------|---------------|---------------|
| 2700K | 3000K | 4000K |
| ○ F021G2MA001 | ○ F021G3MA001 | ○ F021G4MA001 |
| ● F021G2MA006 | ● F021G3MA006 | ● F021G4MA006 |
| ● F021G2MA012 | ● F021G3MA012 | ● F021G4MA012 |
| ● F021G2MA018 | ● F021G3MA018 | ● F021G4MA018 |
| ● F021G2MA030 | ● F021G3MA030 | ● F021G4MA030 |
| ● F021G2MA033 | ● F021G3MA033 | ● F021G4MA033 |

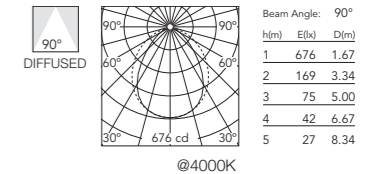

²Quick Install I H2O Stop Fast Connect - Schema elettrico n.8 page 461 / Wiring diagram n.8 page 461

- | | | |
|---------------|---------------|---------------|
| 2700K | 3000K | 4000K |
| ○ F021H2MA001 | ○ F021H3MA001 | ○ F021H4MA001 |
| ● F021H2MA006 | ● F021H3MA006 | ● F021H4MA006 |
| ● F021H2MA012 | ● F021H3MA012 | ● F021H4MA012 |
| ● F021H2MA018 | ● F021H3MA018 | ● F021H4MA018 |
| ● F021H2MA030 | ● F021H3MA030 | ● F021H4MA030 |
| ● F021H2MA033 | ● F021H3MA033 | ● F021H4MA033 |

³Continuous Line I/O H2O Stop Fast Connect - Schema elettrico n.9 page 461 / Wiring diagram n.9 page 461

- | | | |
|---------------|---------------|---------------|
| 2700K | 3000K | 4000K |
| ○ F021J2MA001 | ○ F021J3MA001 | ○ F021J4MA001 |
| ● F021J2MA006 | ● F021J3MA006 | ● F021J4MA006 |
| ● F021J2MA012 | ● F021J3MA012 | ● F021J4MA012 |
| ● F021J2MA018 | ● F021J3MA018 | ● F021J4MA018 |
| ● F021J2MA030 | ● F021J3MA030 | ● F021J4MA030 |
| ● F021J2MA033 | ● F021J3MA033 | ● F021J4MA033 |

Outgraze 50 Easy L 600 - Dimmable DALI

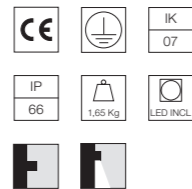
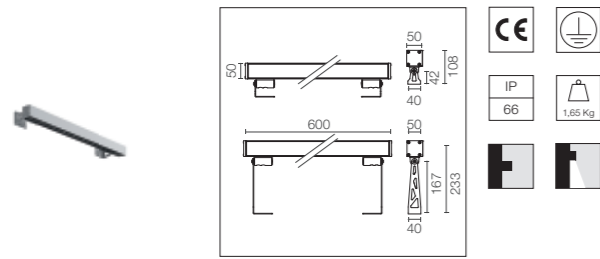

Alimentazione elettrica 120/240V integrata. Staffe di installazione da ordinare separatamente. Vetro sabbato.

Integrated 120/240V power supply. Installation brackets, to be ordered separately. Sandblasted glass.

Mid-power Led: 14,5W - 1440 lm ≠ FIXT 1106 lm - 2700K/CRI 80 - 120-240V / 14,5W - 1560 lm ≠ FIXT 1198 lm - 3000K/CRI 80 - 120-240V / 14,5W - 1680 lm ≠ FIXT 1290 lm - 4000K/CRI 80 - 120-240V

Quick Install I H2O Stop Fast Connect - Schema elettrico n.10 page 462 / Wiring diagram n.10 page 462

2700K

- F021G2KD001
- F021G2KD006
- F021G2KD012
- F021G2KD018
- F021G2KD030
- F021G2KD033

3000K

- F021G3KD001
- F021G3KD006
- F021G3KD012
- F021G3KD018
- F021G3KD030
- F021G3KD033

4000K

- F021G4KD001
- F021G4KD006
- F021G4KD012
- F021G4KD018
- F021G4KD030
- F021G4KD033

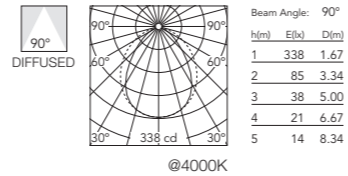

Continuous Line I/O H2O Stop Fast Connect - Schema elettrico n.11 page 462 / Wiring diagram n.11 page 462

2700K

- F021J2KD001
- F021J2KD006
- F021J2KD012
- F021J2KD018
- F021J2KD030
- F021J2KD033

3000K

- F021J3KD001
- F021J3KD006
- F021J3KD012
- F021J3KD018
- F021J3KD030
- F021J3KD033

4000K

- F021J4KD001
- F021J4KD006
- F021J4KD012
- F021J4KD018
- F021J4KD030
- F021J4KD033

Outgraze 50 Easy L 900 - Dimmable DALI

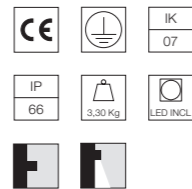
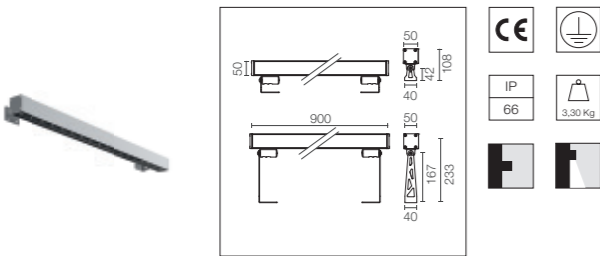

Alimentazione elettrica 120/240V integrata. Staffe di installazione da ordinare separatamente. Vetro sabbato.

Integrated 120/240V power supply. Installation brackets, to be ordered separately. Sandblasted glass.

Mid-power Led: 20W - 2418 lm ≠ FIXT 930 lm - 2700K/CRI 80 - 120-240V / 20W - 2628 lm ≠ FIXT 1011 lm - 3000K/CRI 80 - 120-240V / 20W - 2839 lm ≠ FIXT 1092 lm - 4000K/CRI 80 - 120-240V

Quick Install I H2O Stop Fast Connect - Schema elettrico n.10 page 462 / Wiring diagram n.10 page 462

2700K

- F021G2LD001
- F021G2LD006
- F021G2LD012
- F021G2LD018
- F021G2LD030
- F021G2LD033

3000K

- F021G3LD001
- F021G3LD006
- F021G3LD012
- F021G3LD018
- F021G3LD030
- F021G3LD033

4000K

- F021G4LD001
- F021G4LD006
- F021G4LD012
- F021G4LD018
- F021G4LD030
- F021G4LD033

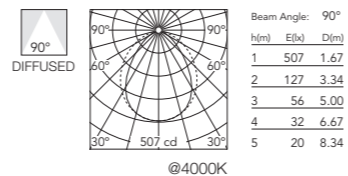

Continuous Line I/O H2O Stop Fast Connect - Schema elettrico n.11 page 462 / Wiring diagram n.11 page 462

2700K

- F021J2LD001
- F021J2LD006
- F021J2LD012
- F021J2LD018
- F021J2LD030
- F021J2LD033

3000K

- F021J3LD001
- F021J3LD006
- F021J3LD012
- F021J3LD018
- F021J3LD030
- F021J3LD033

4000K

- F021J4LD001
- F021J4LD006
- F021J4LD012
- F021J4LD018
- F021J4LD030
- F021J4LD033

²Quick Install In H2O Stop Version: connettore H2O Stop Plug&Play preinstallato per connessione rapida (accessori per collegamento da ordinare) / Prewired H2O Stop Plug&Play connector for an easy/rapid connection (connecting accessory to be ordered separately).

³Continuous Line In/Out H2O Stop Version: connettori H2O Stop Plug&Play preinstallati per connessione in linea (accessori per collegamento da ordinare) / Prewired H2O Stop Plug&Play connectors for an easy in line connection (connecting accessory to be ordered separately).

Outgraze 50 Easy L 1200 - Dimmable DALI

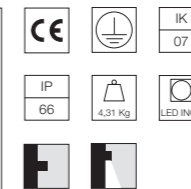
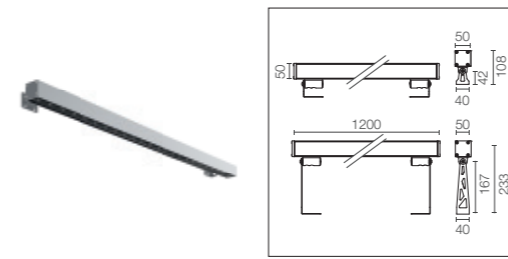

Alimentazione elettrica 120/240V integrata. Staffe di installazione da ordinare separatamente. Vetro sabbato.

Integrated 120/240V power supply. Installation brackets, to be ordered separately. Sandblasted glass.

Power Led: 27W - 3224 lm ≠ FIXT 1240 lm - 2700K/CRI 80 - 120-240V / 27W - 3505 lm ≠ FIXT 1348 lm - 3000K/CRI 80 - 120-240V / 27W - 3785 lm ≠ FIXT 1456 lm - 4000K/CRI 80 - 120-240V

Quick Install I H2O Stop Fast Connect - Schema elettrico n.10 page 462 / Wiring diagram n.10 page 462

2700K

- F021G2MD001
- F021G2MD006
- F021G2MD012
- F021G2MD018
- F021G2MD030
- F021G2MD033

3000K

- F021G3MD001
- F021G3MD006
- F021G3MD012
- F021G3MD018
- F021G3MD030
- F021G3MD033

4000K

- F021G4MD001
- F021G4MD006
- F021G4MD012
- F021G4MD018
- F021G4MD030
- F021G4MD033

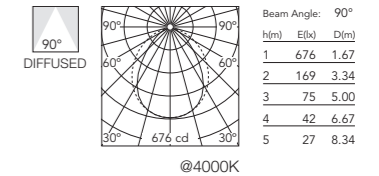

Continuous Line I/O H2O Stop Fast Connect - Schema elettrico n.11 page 462 / Wiring diagram n.11 page 462

2700K

- F021J2MD001
- F021J2MD006
- F021J2MD012
- F021J2MD018
- F021J2MD030
- F021J2MD033

3000K

- F021J3MD001
- F021J3MD006
- F021J3MD012
- F021J3MD018
- F021J3MD030
- F021J3MD033

4000K

- F021J4MD001
- F021J4MD006
- F021J4MD012
- F021J4MD018
- F021J4MD030
- F021J4MD033

²Quick Install In H2O Stop Version: connettore H2O Stop Plug&Play preinstallato per connessione rapida (accessori per collegamento da ordinare) / Prewired H2O Stop Plug&Play connector for an easy/rapid connection (connecting accessory to be ordered separately).

³Continuous Line In/Out H2O Stop Version: connettori H2O Stop Plug&Play preinstallati per connessione in linea (accessori per collegamento da ordinare) / Prewired H2O Stop Plug&Play connectors for an easy in line connection (connecting accessory to be ordered separately).

Outgraze 50 Easy - Tunable White DALI 2700K÷5700K

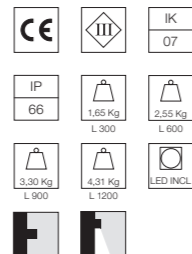
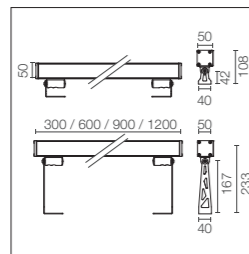

Alimentazione elettrica remota 24V e staffe di installazione da ordinare separatamente.
Vetro sabbato.

24V remote power supply and installation brackets to be ordered separately.
Sandblasted glass.

Mid-power Led: L300: 6,5W - 572 lm ≠ FIXT 220 lm - 2700K/CRI 80 - 24V / L600: 11W - 1143 lm ≠ FIXT 440 lm - 2700K/CRI 80 - 24V / L900: 16W - 1715 lm ≠ FIXT 660 lm - 2700K/CRI 80 - 24V / L1200: 21W - 2286 lm ≠ FIXT 879 lm - 2700K/CRI 80 - 24V

²Quick Install I H2O Stop Fast Connect - Schema elettrico n.13 page 463 / Wiring diagram n.13 page 463

L 300

- F021KTJD001
- F021KTJD006
- F021KTJD012
- F021KTJD018
- F021KTJD030
- F021KTJD033

²Quick Install I H2O Stop Fast Connect - Schema elettrico n.13 page 463 / Wiring diagram n.13 page 463

L 600

- F021KTKD001
- F021KTKD006
- F021KTKD012
- F021KTKD018
- F021KTKD030
- F021KTKD033

³Continuous Line I/O H2O Stop Fast Connect - Schema elettrico n.14 page 463 / Wiring diagram n.14 page 463

L 600

- F021LTKD001
- F021LTKD006
- F021LTKD012
- F021LTKD018
- F021LTKD030
- F021LTKD033

²Quick Install I H2O Stop Fast Connect - Schema elettrico n.13 page 463 / Wiring diagram n.13 page 463

L 900

- F021KTLD001
- F021KTLD006
- F021KTLD012
- F021KTLD018
- F021KTLD030
- F021KTLD033

³Continuous Line I/O H2O Stop Fast Connect - Schema elettrico n.14 page 463 / Wiring diagram n.14 page 463

L 900

- F021LTLD001
- F021LTLD006
- F021LTLD012
- F021LTLD018
- F021LTLD030
- F021LTLD033

²Quick Install I H2O Stop Fast Connect - Schema elettrico n.13 page 463 / Wiring diagram n.13 page 463

L 1200

- F021KTMD001
- F021KTMD006
- F021KTMD012
- F021KTMD018
- F021KTMD030
- F021KTMD033

³Continuous Line I/O H2O Stop Fast Connect - Schema elettrico n.14 page 463 / Wiring diagram n.14 page 463

L 1200

- F021LTMD001
- F021LTMD006
- F021LTMD012
- F021LTMD018
- F021LTMD030
- F021LTMD033

²Quick Install In H2O Stop Version: connettore H2O Stop Plug&Play preinstallato per connessione rapida (accessori per collegamento da ordinare) / Prewired H2O Stop Plug&Play connector for an easy/rapid connection (connecting accessory to be ordered separately).

³Continuous Line In/Out H2O Stop Version: connettori H2O Stop Plug&Play preinstallati per connessione in linea (accessori per collegamento da ordinare) / Prewired H2O Stop Plug&Play connectors for an easy in line connection (connecting accessory to be ordered separately).

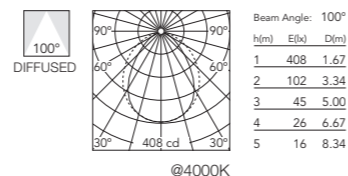
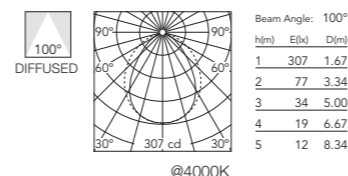
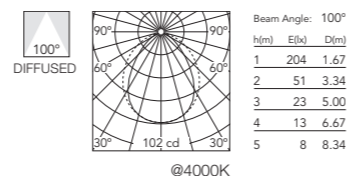
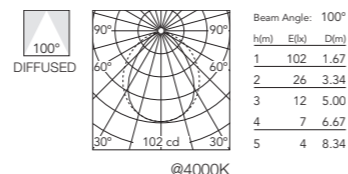

Outgraze 50

Accessori per tutti le versioni / Accessories for all versions

Coppia staffe corte L 80mm.	One pair of short brackets L 80 mm.	○ F1203001 ● F1203006 ● F1203012 ● F1203018 ● F1203030 ● F1203033	
Coppia staffe lunghe L 200mm.	One pair of long brackets L 200mm.	○ F1204001 ● F1204006 ● F1204012 ● F1204018 ● F1204030 ● F1204033	
Sistema di giunzione IP68 H2O Stop anti-condensa a 2 vie 4 poli. (Ø5,5÷12mm cavo).	2 way terminal block 4 poles IP68 H2O Stop. (ø5,5÷12mm cable).	F990C00A000	
Sistema di giunzione IP68 H2O Stop anti-condensa a 3/4 vie 4 poli. (Ø5,5÷12mm cavo).	3/4 way terminal block 4 poles IP68 H2O Stop. (ø5,5÷12mm cable).	F990C010000	
Kit connettore 5 poli presa volante + spina EU IP68.	Connector kit 5-pole flying socket + EU plug IP68.	F990C080000	
Tappo per connettore a pannello (sul prodotto) 4-5 poli.	Cap for panel (on the fixtures) plug connector 4-5 poles.	F021Z070000	

Outgraze 50

Accessori per versioni Non dimmable (220-240V) e Easy Non Dimmable (220-240V) / Accessories for Non Dimmable (220-240V) and Easy Non Dimmable (220-240V) versions

Connettore 4 poli plug&play.	Plug&play connector 4 poles.	F021Z010000	
Doppio connettore 4 poli plug&play + cavo L 600 mm.	Double plug&play connector 4 poles + cable 600 mm lenght.	F021Z020000	
Connettore 4 poli plug&play + cavo L 5000 mm.	Plug&play connector 4 poles + cable 5000 mm lenght.	F021Z030000	





Outgraze 50

Accessori per versioni Quick Install I H2O Stop, Continuous Line I/O H2O Stop e Easy Tunable White (24V) / Accessories for Quick Install I H2O Stop, Continuous Line I/O H2O Stop and Easy Tunable White (24V) versions

Connettore 4 poli plug&play.	Plug&play connector 4 poles.	F021Z010000	
Doppio connettore 4 poli plug&play + cavo L 600 mm. Classe III.	Double plug&play connector 4 poles + cable 600 mm lenght. Class III.	F021Z090000	
Connettore 4 poli plug&play + cavo L 5000 mm. Classe III.	Plug&play connector 4 poles + cable 5000 mm lenght. Class III.	F021Z100000	

Outgraze 50

Accessori per versioni Quick Install I H2O Stop, Continuous Line I/O H2O Stop Dimmerabile DALI, Easy Dimmerabile e Tunable White DALI (120-240V) / Accessories for Quick Install I H2O Stop, Continuous Line I/O H2O Stop Dimmable DALI, Easy Dimmable and Tunable White DALI (120-240V) versions

Connettore 5 poli plug&play.	Plug&play connector 5 poles.	F021Z040000	
Connettore 5 poli plug&play + cavo L 5000 mm.	Plug&play connector 5 poles + cable 5000 mm lenght.	F021Z060000	
Doppio connettore 5 poli plug&play + cavo L 600 mm.	Double plug&play connector 5 poles + cable 600 mm lenght.	F021Z050000	
Scatola di derivazione 5 poli 4 vie IP68 (cavi 6-14 mm).	4 way junction box 5 poles IP68 (6-14 mm cables).	F990C030000	





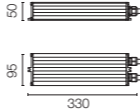

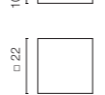

Outgraze 50

Alimentatori per versione Easy Tunable White DALI (24V) / Powers supplies for Easy Tunable White DALI (24V) version

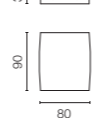
Alimentatore per installazione remota 24V DC 50W / 120-240V IP67 Classe II selv.	Power supply for remote installation 24V DC 50W / 120-240V IP67 Class II selv.	RF25755		
Alimentatore per installazione remota 24V DC 70W / 220-240V IP67 Classe II selv.	Power supply for remote installation 24V DC 70W / 220-240V IP67 Class II selv.	RF25749		
Alimentatore per installazione remota 24V DC 96W / 120-240V IP67 Classe II selv.	Power supply for remote installation 24V DC 96W / 120-240V IP67 Class II selv.	RF25756		

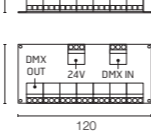
Outgraze 50

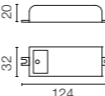
Accessori per gestione RGB-RGBW / Accessories for RGB-RGBW management

Controller DMX a parete per scatole ad incasso (60mm interasse fori).	DMX controller; dimmer switch for recessed box (60mm hole centres).	F990B10A000		
Controller DMX stand-alone/interfaccia pc.	DMX controller; stand-alone/pc interface.	F990B11A000		
DMX splitter 512 - dispositivo elettronico per rigenerare segnale dmx monodirezionale 1 Input e 7 output, 12-24Vdc. Alimentatore non incluso.	DMX splitter 512 - electronic device to regenerate the monodirectional DMX signal 1 Input and 7 output, 12-24Vdc. Power supply not included.	F990B13A000		
Alimentatore 24V 10W / 110-240V IP20 Classe II selv.	Power supply 24V 10W /110-240V IP20 Class II selv.	RF25747		
Cavo DMX schermato con impedenza costante 110 Ohm.	DMX cable - shielded twisted pair with 110 Ohm constant impedance.	F990B12A000		

Outgraze 50

Non Dimmable and Easy Non Dimmable versions

Schema elettrico n.7 / Wiring diagram n.7

Standard: spezzone di cavo in uscita 1000 mm (accessori per collegamento da ordinare) / 1000 mm lenght prewired cable (connecting accessory to be separately ordered)

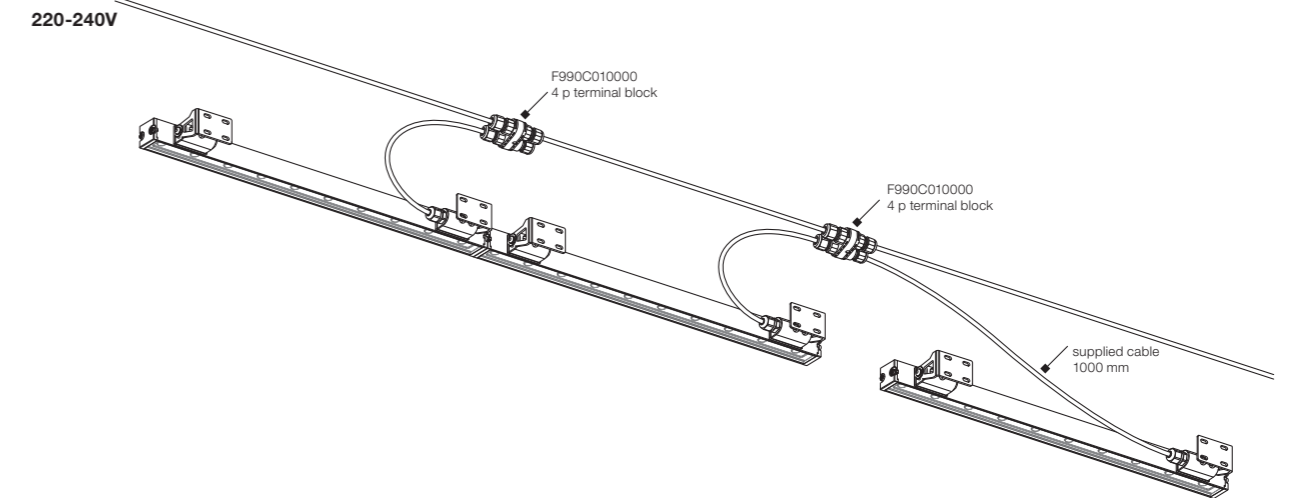

Schema elettrico n.8 / Wiring diagram n.8

Quick Install I H2O Stop Fast Connect: connettore H2O Stop Plug&Play preinstallato per connessione rapida (accessori per collegamento da ordinare) / Prewired H2O Stop Plug&Play connector for an easy/rapid connection (connecting accessory to be ordered separately)

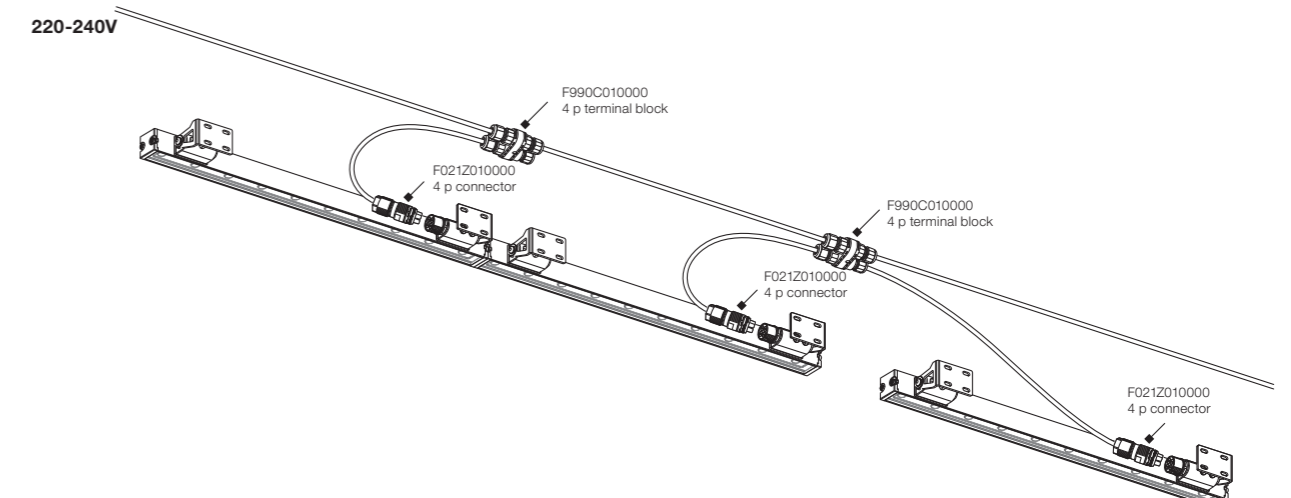

Schema elettrico n.9 / Wiring diagram n.9

Continous Line I/O H2O Stop Fast Connect: connettori H2O Stop Plug&Play preinstallati per connessione in linea (accessori per collegamento da ordinare) / Prewired H2O Stop Plug&Play connectors for an easy in line connection (connecting accessory to be ordered separately)

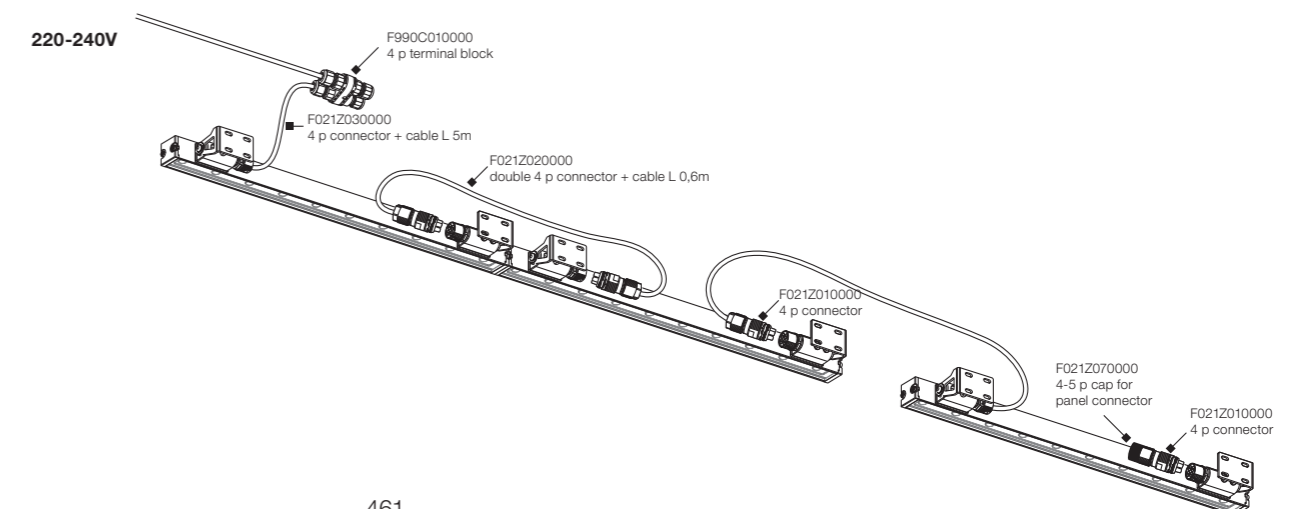

Outgraze 50

Standard Dimmable versions and Tunable White (120-240V) and Dimmable Easy versions

For Dimmable and Tunable White versions

Schema elettrico n.10 / Wiring diagram n.10

Quick Install I H2O Stop: connettore H2O Stop Plug&Play preinstallato per connessione rapida (accessori per collegamento da ordinare) / Prewired H2O Stop Plug&Play connector for an easy/rapid connection (connecting accessory to be ordered separately)

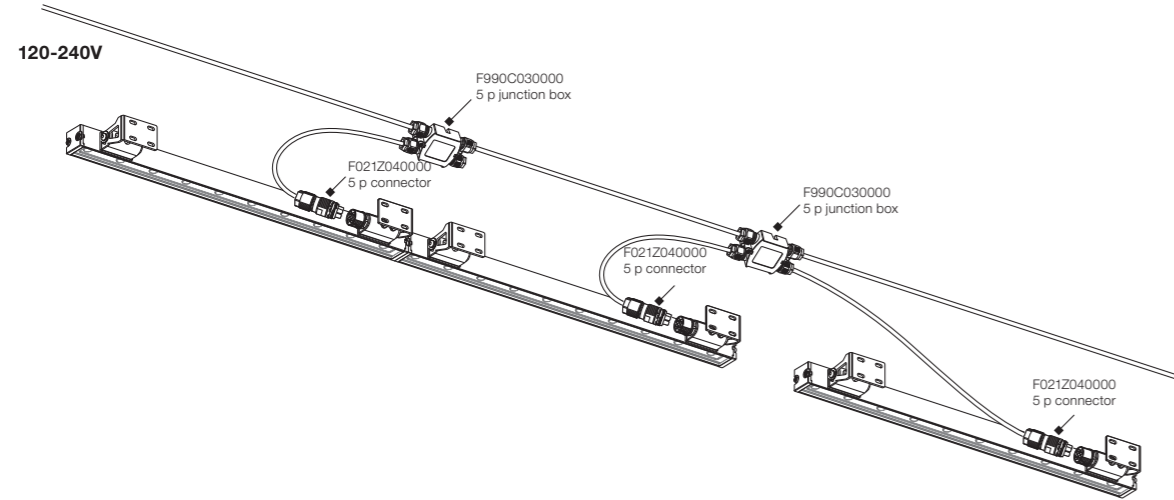

For Dimmable and Tunable White versions

Schema elettrico n.11 / Wiring diagram n.11

Continuous Line I/O H2O Stop Fast Connect: connettori H2O Stop Plug&Play preinstallati per connessione in linea (accessori per collegamento da ordinare) / Prewired H2O Stop Plug&Play connectors for an easy in line connection (connecting accessory to be ordered separately)

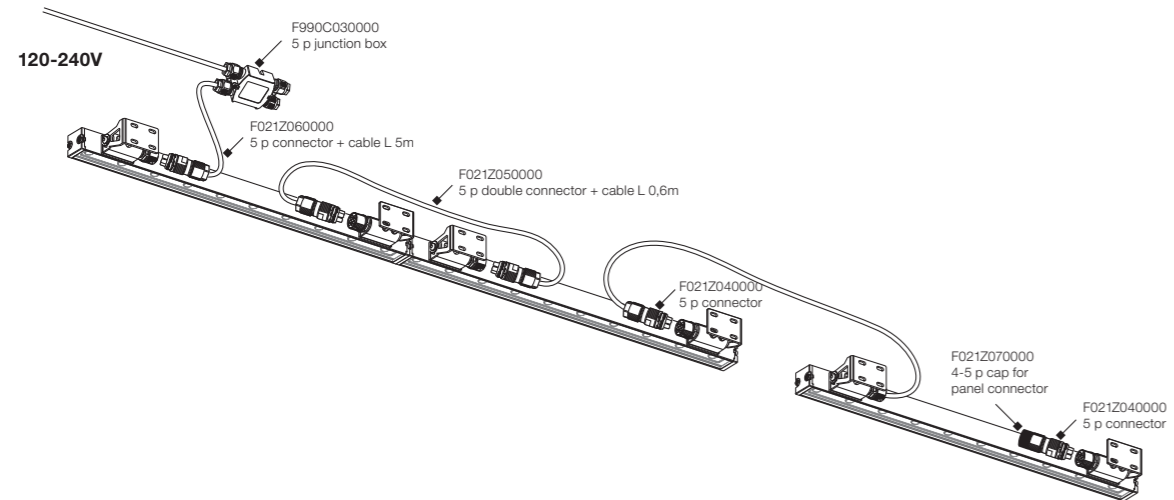

For RGB-RGBW versions

Schema elettrico n.12 / Wiring diagram n.12

Connettori IP68 Plug&Play preinstallati / Prewired IP68 Plug&Play connectors

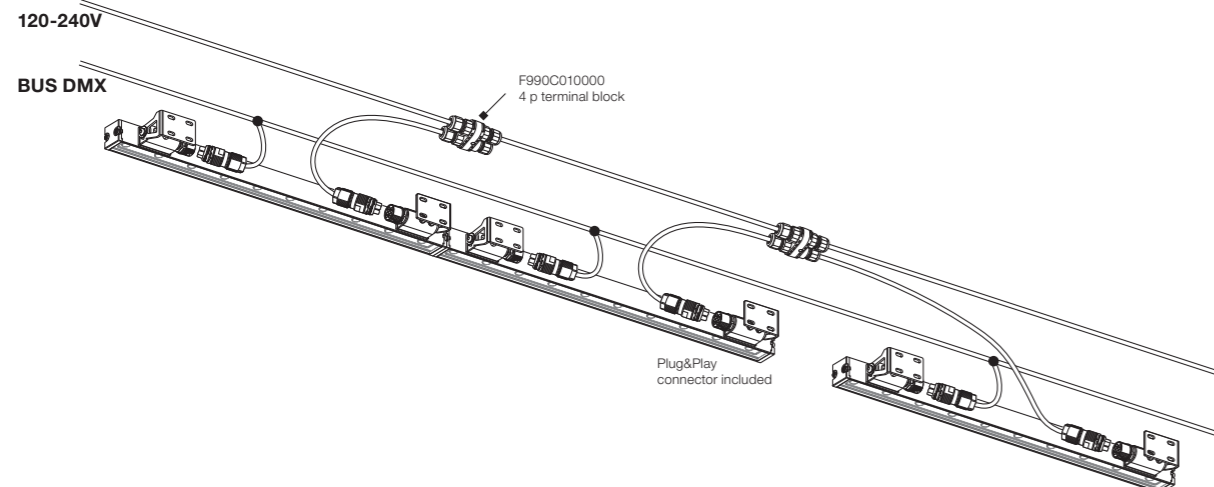

Outgraze 50

Easy Tunable White 24V versions

For Easy Tunable White versions

Schema elettrico n.13 / Wiring diagram n.13

Quick Install I H2O Stop Fast Connect: connettore H2O Stop Plug&Play preinstallato per connessione rapida (accessori per collegamento da ordinare) / Prewired H2O Stop Plug&Play connector for an easy/rapid connection (connecting accessory to be ordered separately)

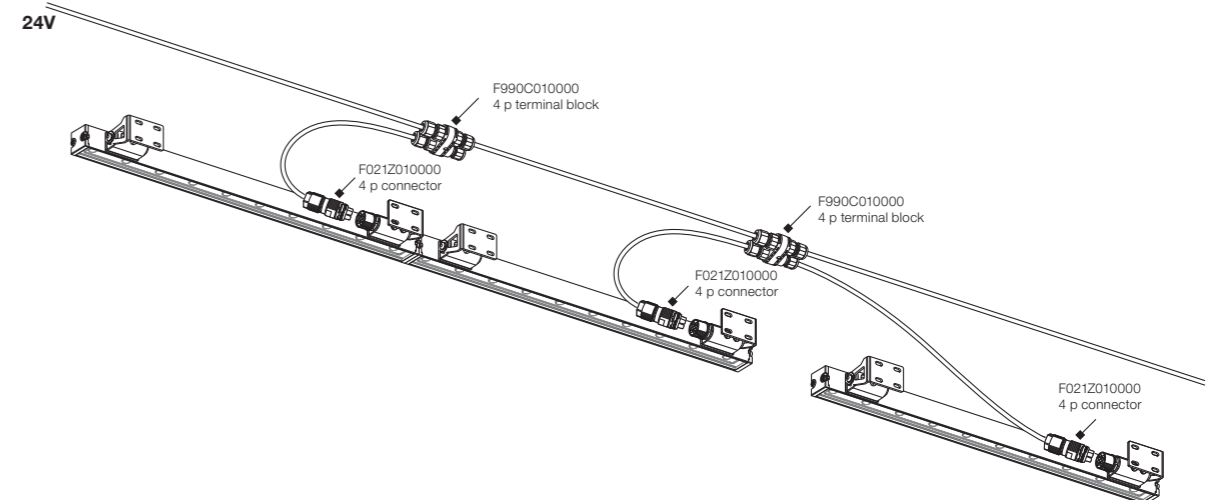

For Easy Tunable White versions

Schema elettrico n.14 / Wiring diagram n.14

Continuous Line I/O H2O Stop Fast Connect: connettori H2O Stop Plug&Play preinstallati per connessione in linea (accessori per collegamento da ordinare) / Prewired H2O Stop Plug&Play connectors for an easy in line connection (connecting accessory to be ordered separately)

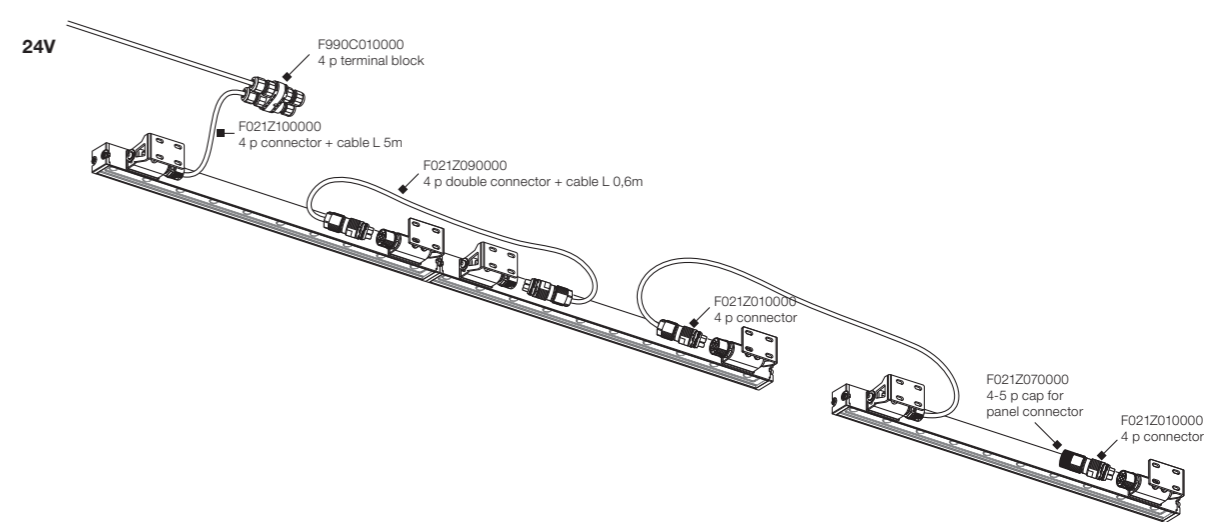

Tau

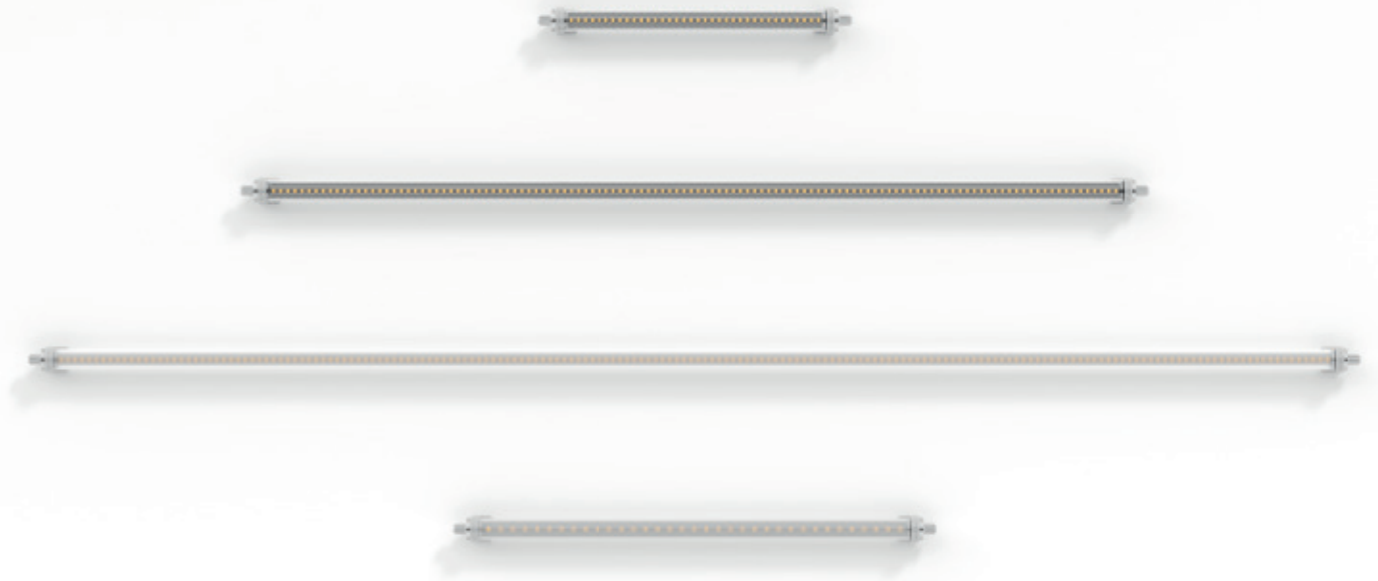



Famiglia / Family

Tau L 354



Low Power Led

up to 3W
up to 231 lm - 2700K/CRI 80
up to 231 lm - 3000K/CRI 80
up to 231 lm - 4000K/CRI 80
* Net lumen output

Tau L 554



Low Power Led

up to 5W
up to 384 lm - 2700K/CRI 80
up to 384 lm - 3000K/CRI 80
up to 384 lm - 4000K/CRI 80
* Net lumen output

Tau L 1054



Low Power Led

up to 10W
up to 768 lm - 2700K/CRI 80
up to 768 lm - 3000K/CRI 80
up to 768 lm - 4000K/CRI 80
* Net lumen output

Tau Opal L 1054



Low Power Led

up to 10W
up to 392 lm - 2700K/CRI 80
up to 392 lm - 3000K/CRI 80
up to 392 lm - 4000K/CRI 80
* Net lumen output

Tau L 1554



Low Power Led

up to 15W
up to 1152 lm - 2700K/CRI 80
up to 1152 lm - 3000K/CRI 80
up to 1152 lm - 4000K/CRI 80
* Net lumen output

Tau Opal L 1554



Low Power Led

up to 15W
up to 589 lm - 2700K/CRI 80
up to 589 lm - 3000K/CRI 80
up to 589 lm - 4000K/CRI 80
* Net lumen output

Descrizione / Description

Apparecchio lineare per installazione a parete o a soffitto con sorgente luminosa a LED. Corpo dell'apparecchio composto da tubo in policarbonato con filtro anti-UV, disponibile in quattro lunghezze nelle finiture opale o trasparente. Staffe di fissaggio in policarbonato sabbato e tappi di chiusura in alluminio anodizzato. Dotato di connettore a vite alle estremità del tubo che richiede l'uso di cavo di alimentazione da ordinare separatamente, disponibile come cavo di lunghezza 2m singolo per connessione diretta all'alimentatore o due cavi per connessione in sequenza, da 8cm o da 20 cm. La lunghezza massima di installazione in sequenza è di 5m. Apparecchio in 24V dc, necessita di alimentatore remoto da ordinare separatamente.

Linear luminaire with LED light source, for installation on wall or ceiling. Polycarbonate tube structure with anti-UV filter. It is available in four lengths and opal or transparent finishes. Frosted polycarbonate fixing brackets and anodized aluminium closing caps. Equipped with screw connectors at the tube's ends which require the use of a feeding cable to be ordered separately. It is supplied with a 2 m cable for a direct connection to the power supply or two 8 cm or 20 cm cables for series connection. Maximum length for in series installation is 5 m. The 24 V dc luminaire is powered by a remote power supply to be ordered separately.

Tau L 354

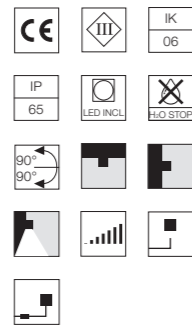
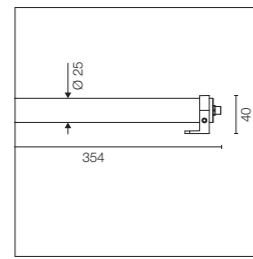

Sorgente a LED inclusa.
Connettore a vite alle estremità del tubo. Alimentazione elettrica remota 24Vdc e cavi di alimentazione singolo o in sequenza da ordinare separatamente.
Diffusore policarbonato trasparente.
Dimmerabile.

LED light source included.
Screw connector at the tube's end. 24V dc remote electric power supply and individual or series feeding cables, to be ordered separately.
Transparent polycarbonate diffuser.
Adjustable light intensity.

Low - Power Led: 3W - 255 lm ≠ OUTPUT 231 lm - 2700K/CRI 80 - 24Vdc / 3W - 255 lm ≠ OUTPUT 231 lm - 3000K/CRI 80 - 24Vdc / 3W - 255 lm ≠ OUTPUT 231 lm - 4000K/CRI 80 - 24Vdc

2700K FA523203 **3000K** FA523003 **4000K** FA523002

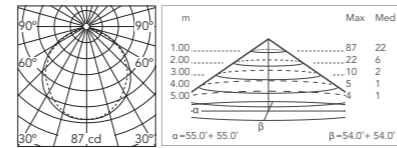

@ 4000K

Tau Opal L 354

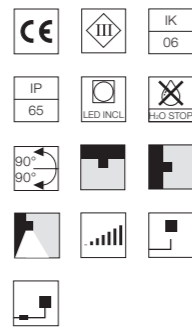
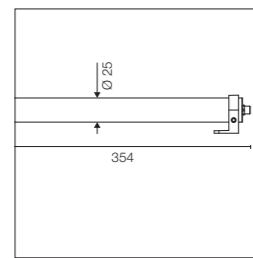

Sorgente a LED inclusa.
Connettore a vite alle estremità del tubo. Alimentazione elettrica remota 24Vdc e cavi di alimentazione singolo o in sequenza da ordinare separatamente.
Diffusore policarbonato opale.
Dimmerabile.

LED light source included.
Screw connector at the tube's end. 24V dc remote electric power supply and individual or series feeding cables, to be ordered separately.
Opal polycarbonate diffuser.
Adjustable light intensity.

Low - Power Led: 3W - 255 lm ≠ OUTPUT 118 lm - 2700K/CRI 80 - 24Vdc / 3W - 255 lm ≠ OUTPUT 118 lm - 3000K/CRI 80 - 24Vdc / 3W - 255 lm ≠ OUTPUT 118 lm - 4000K/CRI 80 - 24Vdc

2700K FA523213 **3000K** FA523013 **4000K** FA523012

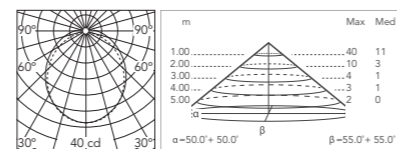

@ 4000K

* Numero massimo di apparecchi per alimentatore / Maximum number of luminaires per power supply.

Numero massimo di apparecchi per alimentatore (Vin220+240). Dati indicativi da verificare con le specifiche condizioni di installazione.	Maximum number of luminaires per power supply. (220+240 V). These data must be checked taking into account the specific installation conditions.	Acc. RF25754	2	Acc. RF26387	5
		Acc. RF25748	2	Acc. RF25752	6
		Acc. RF25747	3	Acc. RF25755	16
		Acc. RF25757	3	Acc. RF25749	22
		Acc. RF25750	5	Acc. RF25756	30
		Acc. F990B21A000	5		

Tau L 554

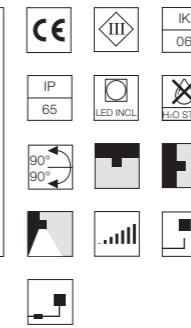
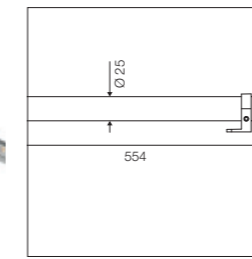

Sorgente a LED inclusa.
Connettore a vite alle estremità del tubo. Alimentazione elettrica remota 24Vdc e cavi di alimentazione singolo o in sequenza da ordinare separatamente.
Diffusore policarbonato trasparente.
Dimmerabile.

LED light source included.
Screw connector at the tube's end. 24V dc remote electric power supply and individual or series feeding cables, to be ordered separately.
Transparent polycarbonate diffuser.
Adjustable light intensity.

Low - Power Led: 5W - 420 lm ≠ OUTPUT 384 lm - 2700K/CRI 80 - 24Vdc / 5W - 420 lm ≠ OUTPUT 384 lm - 3000K/CRI 80 - 24Vdc / 5W - 420 lm ≠ OUTPUT 384 lm - 4000K/CRI 80 - 24Vdc

2700K FA523223 **3000K** FA523023 **4000K** FA523022

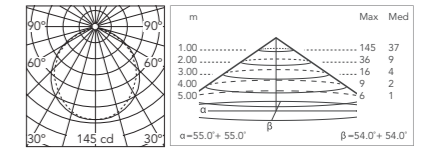

@ 4000K

Tau Opal L 554

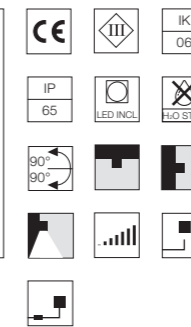
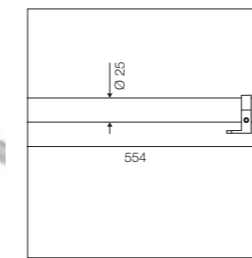

Sorgente a LED inclusa.
Connettore a vite alle estremità del tubo. Alimentazione elettrica remota 24Vdc e cavi di alimentazione singolo o in sequenza da ordinare separatamente.
Diffusore policarbonato opale.
Dimmerabile.

LED light source included.
Screw connector at the tube's end. 24V dc remote electric power supply and individual or series feeding cables, to be ordered separately.
Opal polycarbonate diffuser.
Adjustable light intensity.

Low - Power Led: 5W - 420 lm ≠ OUTPUT 196 lm - 2700K/CRI 80 - 24Vdc / 5W - 420 lm ≠ OUTPUT 196 lm - 3000K/CRI 80 - 24Vdc / 5W - 420 lm ≠ OUTPUT 196 lm - 4000K/CRI 80 - 24Vdc

2700K FA523233 **3000K** FA523033 **4000K** FA523032

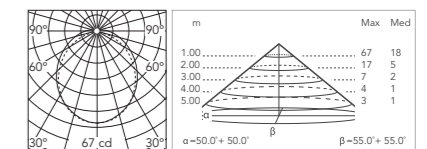

@ 4000K

* Numero massimo di apparecchi per alimentatore / Maximum number of luminaires per power supply.

Numero massimo di apparecchi per alimentatore (Vin220+240). Dati indicativi da verificare con le specifiche condizioni di installazione.	Maximum number of luminaires per power supply. (220+240 V). These data must be checked taking into account the specific installation conditions.	Acc. RF25754	1	Acc. RF26387	3
		Acc. RF25748 <td>1</td> <td>Acc. RF25752 <td>4</td> </td>	1	Acc. RF25752 <td>4</td>	4
		Acc. RF25747 <td>2</td> <td>Acc. RF25755 <td>10</td> </td>	2	Acc. RF25755 <td>10</td>	10
		Acc. RF25757 <td>2</td> <td>Acc. RF25749 <td>14</td> </td>	2	Acc. RF25749 <td>14</td>	14
		Acc. RF25750 <td>3</td> <td>Acc. RF25756 <td>18</td> </td>	3	Acc. RF25756 <td>18</td>	18
		Acc. F990B21A000 <td>3</td> <td></td> <td></td>	3		

Tau L 1054

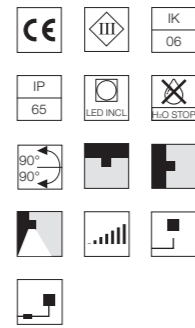
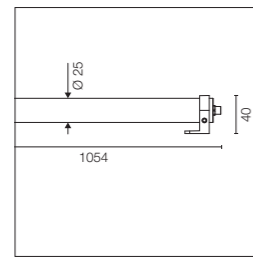

Sorgente a LED inclusa.
Connettore a vite alle estremità del tubo. Alimentazione elettrica remota 24Vdc e cavi di alimentazione singolo o in sequenza da ordinare separatamente.
Diffusore policarbonato trasparente.
Dimmerabile.

LED light source included.
Screw connector at the tube's end. 24V dc remote electric power supply and individual or series feeding cables, to be ordered separately.
Transparent polycarbonate diffuser.
Adjustable light intensity.

Low - Power Led: 10W - 840 lm ≠ OUTPUT 768 lm - 2700K/CRI 80 - 24Vdc / 10W - 840 lm ≠ OUTPUT 768 lm - 3000K/CRI 80 - 24Vdc / 10W - 840 lm ≠ OUTPUT 768 lm - 4000K/CRI 80 - 24Vdc

2700K FA523243
3000K FA523043
4000K FA523042

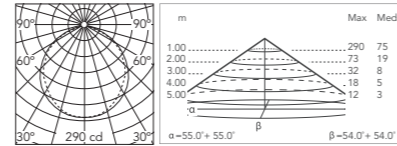

@ 4000K

Tau Opal L 1054

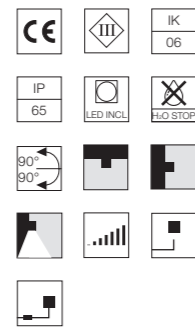
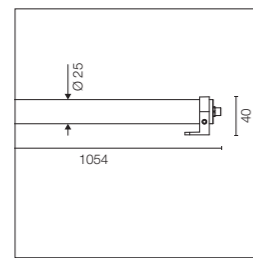

Sorgente a LED inclusa.
Connettore a vite alle estremità del tubo. Alimentazione elettrica remota 24Vdc e cavi di alimentazione singolo o in sequenza da ordinare separatamente.
Diffusore policarbonato opale.
Dimmerabile.

LED light source included.
Screw connector at the tube's end. 24V dc remote electric power supply and individual or series feeding cables, to be ordered separately.
Opal polycarbonate diffuser.
Adjustable light intensity.

Low - Power Led: 10W - 840 lm ≠ OUTPUT 393 lm - 2700K/CRI 80 - 24Vdc / 10W - 840 lm ≠ OUTPUT 393 lm - 3000K/CRI 80 - 24Vdc / 10W - 840 lm ≠ OUTPUT 393 lm - 4000K/CRI 80 - 24Vdc

2700K FA523253
3000K FA523053
4000K FA523052

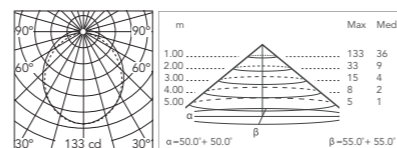

@ 4000K

* Numero massimo di apparecchi per alimentatore / Maximum number of luminaires per power supply.

Numero massimo di apparecchi per alimentatore (Vin220+240). Dati indicativi da verificare con le specifiche condizioni di installazione.	Maximum number of luminaires per power supply. (220+240 V). These data must be checked taking into account the specific installation conditions.	Acc. RF25750	1	Acc. RF25755	5
		Acc. F990B21A000	1	Acc. RF25749	7
		Acc. RF26387	1	Acc. RF25756	9
		Acc. RF25752	2		

Tau L 1554

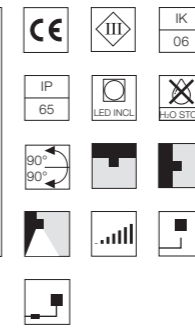
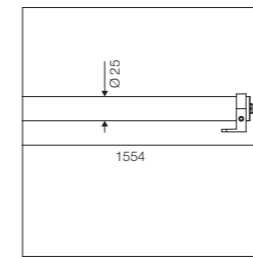

Sorgente a LED inclusa.
Connettore a vite alle estremità del tubo. Alimentazione elettrica remota 24Vdc e cavi di alimentazione singolo o in sequenza da ordinare separatamente.
Diffusore policarbonato trasparente.
Dimmerabile.

LED light source included.
Screw connector at the tube's end. 24V dc remote electric power supply and individual or series feeding cables, to be ordered separately.
Transparent polycarbonate diffuser.
Adjustable light intensity.

Low - Power Led: 15W - 1260 lm ≠ OUTPUT 1152 lm - 2700K/CRI 80 - 24Vdc / 15W - 1260 lm ≠ OUTPUT 1152 lm - 3000K/CRI 80 - 24Vdc / 15W - 1260 lm ≠ OUTPUT 1152 lm - 4000K/CRI 80 - 24Vdc

2700K FA523263
3000K FA523063
4000K FA523062

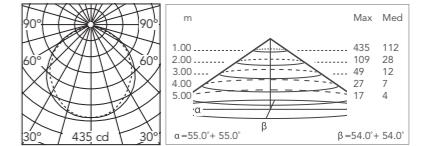

@ 4000K

Tau Opal L 1554

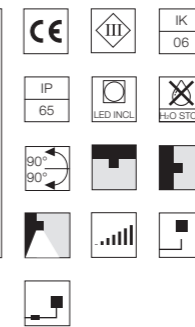
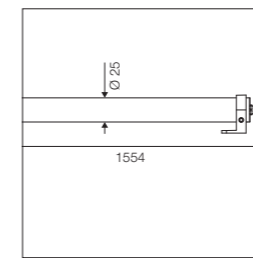

Sorgente a LED inclusa.
Connettore a vite alle estremità del tubo. Alimentazione elettrica remota 24Vdc e cavi di alimentazione singolo o in sequenza da ordinare separatamente.
Diffusore policarbonato opale.
Dimmerabile.

LED light source included.
Screw connector at the tube's end. 24V dc remote electric power supply and individual or series feeding cables, to be ordered separately.
Opal polycarbonate diffuser.
Adjustable light intensity.

Low - Power Led: 15W - 1260 lm ≠ OUTPUT 589 lm - 2700K/CRI 80 - 24Vdc / 15W - 1260 lm ≠ OUTPUT 589 lm - 3000K/CRI 80 - 24Vdc / 15W - 1260 lm ≠ OUTPUT 589 lm - 4000K/CRI 80 - 24Vdc

2700K FA523273
3000K FA523073
4000K FA523072

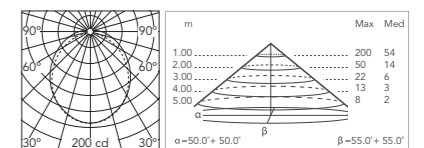



@ 4000K











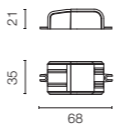

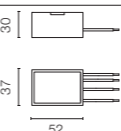

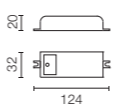

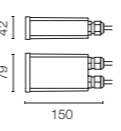
* Numero massimo di apparecchi per alimentatore / Maximum number of luminaires per power supply.

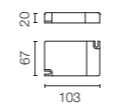
Numero massimo di apparecchi per alimentatore (Vin220+240). Dati indicativi da verificare con le specifiche condizioni di installazione.	Maximum number of luminaires per power supply. (220+240 V). These data must be checked taking into account the specific installation conditions.	Acc. RF25750	1	Acc. RF25755	3
		Acc. F990B21A000	1	Acc. RF25749	4
		Acc. RF26387	1	Acc. RF25756	6
		Acc. RF25752	1		

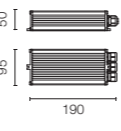

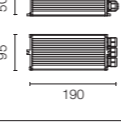

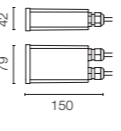
Tau: Accessori / Accessories

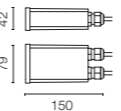
Cavo di alimentazione L.2000mm. Connettore singolo.	Supply cable L.2000mm Single connector.	FA172	
Cavo di alimentazione L.80mm. Connettore doppio.	Supply cable L.80mm Double connector.	FA173	
Cavo di alimentazione L.200mm. Connettore doppio.	Supply cable L.200mm Double connector.	FA174	

Tau: Driver / Drivers

Alimentatore doppia funzione Vout 24Vdc: 8W/100÷240V Iout 350ma: 6x1W/100÷240V IP20 Classe II Selv Eq.	Power supply dual function Vout 24Vdc: 8W/100÷240V Iout 350ma: 6x1W/100÷240V IP20 Class II Selv Eq.	Tau L 554 *RF25754		
Alimentatore 24V 8W / 110-240V IP65 Classe II selv.	Power supply 24V 8W / 110-240V IP65 Class II selv.	Tau L 554 *RF25748		
Alimentatore 24V 10W / 110-240V IP20 Classe II selv.	Power supply 24V 10W / 110-240V IP20 Class II selv.	Tau L 554 *RF25747		
Alimentatore 24V 10W / 110-240V IP67 Classe II selv.	Power supply 24V 10W / 110-240V IP67 Class II selv.	Tau L 554 *RF25757		
Alimentatore per installazione remota 24Vdc 17W / 110-240V (15W@110V) IP20 Classe II selv.	Power supply for remote installation 24Vdc 17W / 110-240V (15W@110V) IP20 Class II selv.	*RF25750 Dimmable Push-Dim Or 1-10V See Wiring Diagram n.4. Page 668.		
Alimentatore 17W/110÷240V - 24Vdc (15W@110V) IP67 Classe II Selv.	Power supply 17W/110÷240V - 24Vdc (15W@110V) IP67 Class II Selv.	*F990B21A000 Dimmable Push-Dim Or 1-10V See Wiring Diagram n.4. Page 668.		
Alimentatore per installazione remota 24Vdc 20W / 110-240Vdc (15W@110V) IP67 Classe II selv.	Power supply for remote installation 24Vdc 20W / 110-240Vdc (15W@110V) IP67 Class II selv.	*RF26387 Dimmable DALI See Wiring Diagram n.4. Page 668.		
Alimentatore per installazione remota 24Vdc 20W / 220-240V IP67 Classe II selv.	Power supply for remote installation 24Vdc 20W / 220-240V IP67 Class II selv.	*RF25752		
Alimentatore 24Vdc 35W / 120-270V IP67 Classe II selv.	Power supply 24Vdc 35W / 120-270V IP67 Class II selv.	F990B23AZ00		

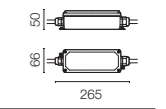
Tau: Driver / Drivers

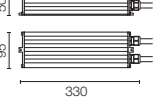
Alimentatore per installazione remota 24Vdc 50W / 120-240V IP67 Classe II selv.	Power supply for remote installation 24Vdc 50W / 120-240V IP67 Class II selv.	*RF25755		
Alimentatore per installazione remota 24Vdc 70W / 220-240V IP67 Classe II selv.	Power supply for remote installation 24Vdc 70W / 220-240V IP67 Class II selv.	*RF25749		
Alimentatore per installazione remota 24Vdc 96W / 120-240V IP67 Classe II selv.	Power supply for remote installation 24Vdc 96W / 120-240V IP67 Class II selv.	*RF25756		

Esempio di configurazione / Example of configuration

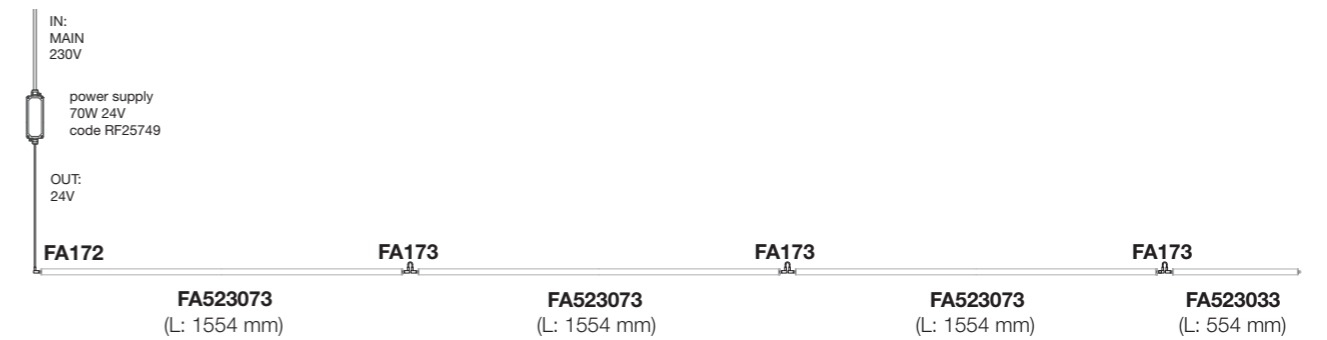

Massima lunghezza in fila continua 5mt / Max length in continuous 5mt

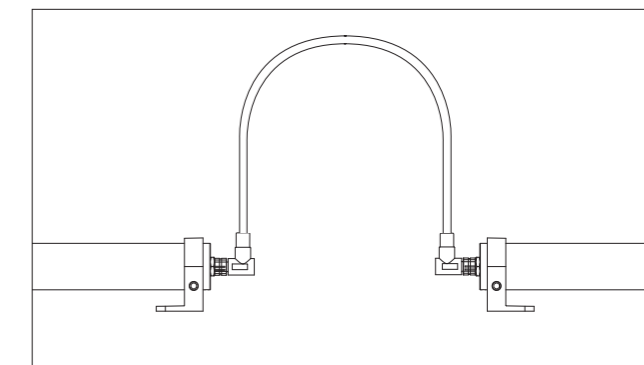
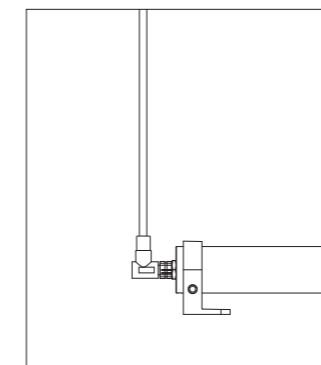

Cielo



Cielo



Famiglia / Family

Cielo L 645



Power Led

up to 16W
up to 1222 lm - 2700K/CRI 80
up to 1314 lm - 3000K/CRI 80
up to 1423 lm - 4000K/CRI 80

* Net lumen output

Cielo L 1245



Power Led

up to 32W
up to 2444 lm - 2700K/CRI 80
up to 2628 lm - 3000K/CRI 80
up to 2847 lm - 4000K/CRI 80

* Net lumen output

Cielo Opal L 645 RGB



RGB - Power Led

up to 26W

* Net lumen output

Cielo Opal L 1245 RGB



RGB - Power Led

up to 26W

* Net lumen output

Descrizione / Description

Apparecchio lineare da incasso a terra calpestabile, installabile anche a parete e a soffitto con cassaforma dedicata, o in controsoffitto con apposito telaio. Corpo in estruso in alluminio con doppia testata di chiusura in alluminio pressofuso lega EN AB 47100 (a basso contenuto di rame). Diffusore in vetro temprato spessore 8mm, trasparente o sabbiato, con bordo serigrafato fissato attraverso un sistema di incollaggio robotizzato. L'apparecchio è cablato con due pressacavi M20 in materiale plastico posizionati ad un estremo per il collegamento al modulo elettrico, fissato su una piastra estraibile; l'ottica basculante sull'asse verticale garantisce maggiore flessibilità di puntamento. Completano la gamma le versioni RGB per la creazione di scenografie luminose colorate; nelle versioni RGB l'apparecchio è dotato di due spezzoni di cavo per una facile connessione. L'installazione richiede una cassaforma da incasso da ordinare separatamente. È necessario garantire un livello adeguato di materiale drenante sotto la cassaforma o fornire un sistema di scarico per evitare il ristagno di acqua. Per garantire la tenuta del pressacavo è necessario utilizzare cavi elettrici flessibili idonei all'impiego in ambienti esterni.

Linear ground-recessed walkable luminaire. It can also be wall or ceiling mounted with a specific junction box and in a false ceiling with a specific structure. Extruded aluminum body with EN AB-47100 die cast aluminum double header (with low copper content). 8mm thick tempered glass diffuser, transparent or frosted, with silkscreen edge and attached with a robotic gluing system. The luminaire is cabled with two M20 plastic cable guides. Set at one of the ends, they connect the luminaire with the electric module fixed on a removable panel. The tilting spotlight on the vertical axis facilitates the direction of the light beam. To complete the series, there's also the RGB version which allows the creation of colored light sceneries. In this version, the luminaire has two cable indicators for an easier connection. The installation requires a specific box that needs to be ordered separately. To avoid water stagnation, the bottom part of said box needs to be isolated with a layer of draining material or another drain system. To ensure the preservation of the cable guide it's recommended to use flexible electric cables suitable for exterior use.

Colori / Colours



06 Grey



33 Anthracite

Cielo L 645

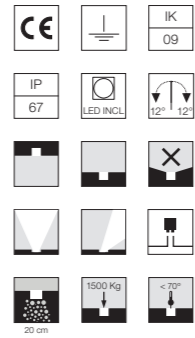
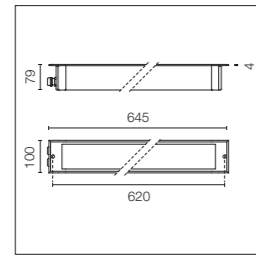

Sorgente a LED inclusa. Alimentazione elettrica 220-240V ON/ OFF e dimmerabile 1-10V o DALI integrata. Orientabilità asse verticale: max 12°. Necessaria cassaforma da incasso o telaio per cartongesso da ordinare separatamente. Dotato di due pressacavi M20 in materiale plastico (cavi 6< ϕ <12mm) per il collegamento al modulo elettrico per connessione a tenuta stagna. Vetro trasparente extrachiaro.

LED source included. Integrated power supply 220-240V ON/ OFF and dimmable 1-10V or DALI. Adjustment on the vertical axis: max. 12°. The necessary junction box or the structure for plasterboard installation need to be ordered separately. With two M20 cable guides (6< ϕ <12mm cables) for the connection to the watertight electrical module. Extraclear transparent glass.

Optic Spot 10°

Power Led: 16W - 1339 lm \neq OUTPUT 1222 lm - 2700K/CRI 80 - 220 \div 240V / 16W - 1440 lm \neq OUTPUT 1314 lm - 3000K/CRI 80 - 220 \div 240V / 16W - 1560 lm \neq OUTPUT 1423 lm - 4000K/CRI 80 - 220 \div 240V

2700K

- Non Dimmable
- FA94851206
- FA94851233
- 1-10V
- FA94851206-310
- FA94851233-310
- Dali
- FA94851206-300
- FA94851233-300

3000K

- Non Dimmable
- FA94831206
- FA94831233
- 1-10V
- FA94831206-310
- FA94831233-310
- Dali
- FA94831206-300
- FA94831233-300

4000K

- Non Dimmable
- FA941861206
- FA941861233
- 1-10V
- FA941861206-310
- FA941861233-310
- Dali
- FA941861206-300
- FA941861233-300

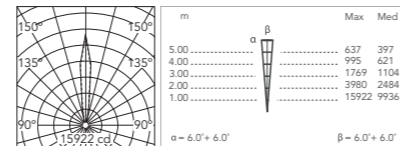

Optic Medium 45°

Power Led: 16W - 1339 lm \neq OUTPUT 1071 lm - 2700K/CRI 80 - 220 \div 240V / 16W - 1440 lm \neq OUTPUT 1152 lm - 3000K/CRI 80 - 220 \div 240V / 16W - 1560 lm \neq OUTPUT 1248 lm - 4000K/CRI 80 - 220 \div 240V

2700K

- Non Dimmable
- FA94851306
- FA94851333
- 1-10V
- FA94851306-310
- FA94851333-310
- Dali
- FA94851306-300
- FA94851333-300

3000K

- Non Dimmable
- FA94831306
- FA94831333
- 1-10V
- FA94831306-310
- FA94831333-310
- Dali
- FA94831306-300
- FA94831333-300

4000K

- Non Dimmable
- FA941861306
- FA941861333
- 1-10V
- FA941861306-310
- FA941861333-310
- Dali
- FA941861306-300
- FA941861333-300

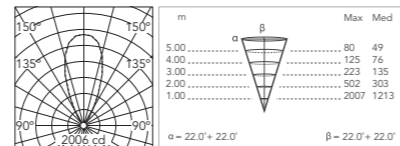

Elliptical Optic - 12°+ 54°

Power Led: 16W - 1339 lm \neq OUTPUT 1074 lm - 2700K/CRI 80 - 220 \div 240V / 16W - 1440 lm \neq OUTPUT 1155 lm - 3000K/CRI 80 - 220 \div 240V / 16W - 1560 lm \neq OUTPUT 1251 lm - 4000K/CRI 80 - 220 \div 240V

2700K

- Non Dimmable
- FA948513106
- FA948513133
- 1-10V
- FA948513106-310
- FA948513133-310
- Dali
- FA948513106-300
- FA948513133-300

3000K

- Non Dimmable
- FA948313106
- FA948313133
- 1-10V
- FA948313106-310
- FA948313133-310
- Dali
- FA948313106-300
- FA948313133-300

4000K

- Non Dimmable
- FA9418613106
- FA9418613133
- 1-10V
- FA9418613106-310
- FA9418613133-310
- Dali
- FA9418613106-300
- FA9418613133-300

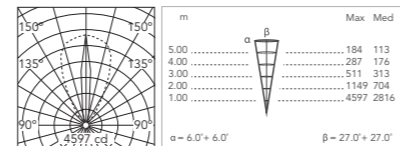

Cielo Opal L 645 RGB

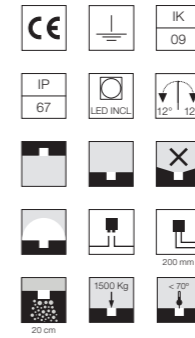
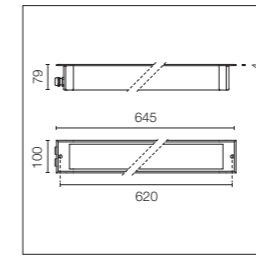

Sorgente RGB a LED inclusa. Alimentazione elettrica 220-240V con interfaccia DMX-RDM integrata. Orientabilità asse verticale: max 12°. Necessaria cassaforma da incasso o telaio per cartongesso da ordinare separatamente. Dotato di due spezzoni di cavo uscente in neoprene 200 mm e kit con connettori crimp e guaina termorestringente adesiva per connessione a tenuta stagna. Vetro sabbato.

RGB LED source included. Electrical power supply 220-240V with integrated DMX-RDM interface. Adjustment on the vertical axis: max. 12°. The necessary junction box or the structure for plasterboard installation need to be ordered separately. Equipped with two 200mm protruding sections of neoprene cable and a kit with crimpable connectors and adhesive heat-shrinkable sleeves that guarantee the tightness of the connection. Frosted glass.

Schema elettrico e installazione sistema RGB.

Vedere Schema Elettrico n.8 Page 671.

Wiring diagram and installation scheme RGB.

See Wiring Diagram n.8 Page 671.

RGB Power Led: 26W - 220 \div 240V

RGB

- FA941871306
- FA941871333

Photometric data on request.

Cielo L 1245

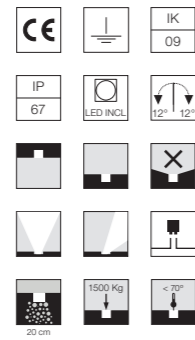
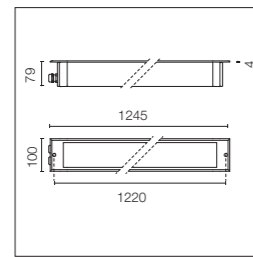

Sorgente a LED inclusa.
Alimentazione elettrica 220-240V ON/ OFF e dimmerabile 1-10V o DALI integrata.
Orientabilità asse verticale: max 12°. Necessaria cassaforma da incasso o telaio per cartongesso da ordinare separatamente.
Dotato di due pressacavi M20 in materiale plastico (cavi 6ϕ<math><12\text{mm}</math>) per il collegamento al modulo elettrico per connessione a tenuta stagna.
Vetro trasparente extrachiaro.

LED source included. Integrated power supply 220-240V ON/ OFF and dimmable 1-10V or DALI. Adjustment on the vertical axis: max. 12°. The necessary junction box or the structure for plasterboard installation need to be ordered separately. With two M20 cable guides (6ϕ<math><12\text{mm}</math> cables) for the connection to the watertight electrical module.
Extraclear transparent glass.

Optic Spot 10°

Power Led: 32W - 2678 lm \neq OUTPUT 2444 lm - 2700K/CRI 80 - 220÷240V / 32W - 2880 lm \neq OUTPUT 2628 lm - 3000K/CRI 80 - 220÷240V / 32W - 3120 lm \neq OUTPUT 2847 lm - 4000K/CRI 80 - 220÷240V

2700K	3000K	4000K
Non Dimmable	Non Dimmable	Non Dimmable
● FA94861206	● FA94801206	● FA941881206
● FA94861233	● FA94801233	● FA941881233
1-10V	1-10V	1-10V
● FA94861206-310	● FA94801206-310	● FA941881206-310
● FA94861233-310	● FA94801233-310	● FA941881233-310
Dali	Dali	Dali
● FA94861206-300	● FA94801206-300	● FA941881206-300
● FA94861233-300	● FA94801233-300	● FA941881233-300

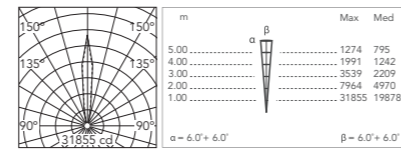

Optic Medium 45°

Power Led: 32W - 2678 lm \neq OUTPUT 2142 lm - 2700K/CRI 80 - 220÷240V / 32W - 2880 lm \neq OUTPUT 2303 lm - 3000K/CRI 80 - 220÷240V / 32W - 3120 lm \neq OUTPUT 2495 lm - 4000K/CRI 80 - 220÷240V

2700K	3000K	4000K
Non Dimmable	Non Dimmable	Non Dimmable
● FA94861306	● FA94801306	● FA941881306
● FA94861333	● FA94801333	● FA941881333
1-10V	1-10V	1-10V
● FA94861306-310	● FA94801306-310	● FA941881306-310
● FA94861333-310	● FA94801333-310	● FA941881333-310
Dali	Dali	Dali
● FA94861306-300	● FA94801306-300	● FA941881306-300
● FA94861333-300	● FA94801333-300	● FA941881333-300

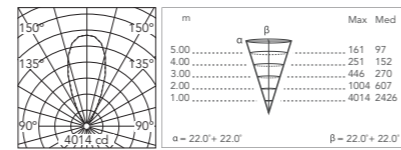

Elliptical Optic - 12°+ 54°

Power Led: 32W - 2678 lm \neq OUTPUT 2148 lm - 2700K/CRI 80 - 220÷240V / 32W - 2880 lm \neq OUTPUT 2310 lm - 3000K/CRI 80 - 220÷240V / 32W - 3120 lm \neq OUTPUT 2503 lm - 4000K/CRI 80 - 220÷240V

2700K	3000K	4000K
Non Dimmable	Non Dimmable	Non Dimmable
● FA948613106	● FA948013106	● FA9418813106
● FA948613133	● FA948013133	● FA9418813133
1-10V	1-10V	1-10V
● FA948613106-310	● FA948013106-310	● FA9418813106-310
● FA948613133-310	● FA948013133-310	● FA9418813133-310
Dali	Dali	Dali
● FA948613106-300	● FA948013106-300	● FA9418813106-300
● FA948613133-300	● FA948013133-300	● FA9418813133-300

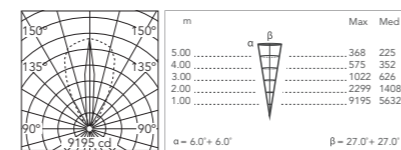

Cielo Opal L 1245 RGB

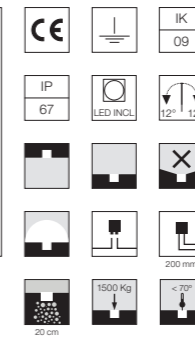
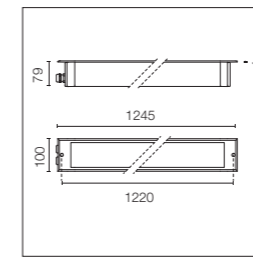

Sorgente RGB a LED inclusa.
Alimentazione elettrica 220-240V con interfaccia DMX-RDM integrata. Orientabilità asse verticale: max 12°. Necessaria cassaforma da incasso o telaio per cartongesso da ordinare separatamente. Dotato di due spezzoni di cavo uscente in neoprene 200 mm e kit con connettori crimp e guaina termorestringente adesiva per connessione a tenuta stagna.
Vetro sabbiato.

RGB LED source included. Electrical power supply 220-240V with integrated DMX-RDM interface. Adjustment on the vertical axis: max. 12°. The necessary junction box or the structure for plasterboard installation need to be ordered separately. Equipped with two 200mm protruding sections of neoprene cable and a kit with crimpable connectors and adhesive heat-shrinkable sleeves that guarantee the tightness of the connection.
Frosted glass.

Schema elettrico e installazione sistema RGB.

Vedere Schema Elettrico n.8 Page 671.

Wiring diagram and installation scheme RGB.

See Wiring Diagram n.8 Page 671.



RGB Power Led: 48W - 220÷240V

RGB

- FA941891306
- FA941891333

Photometric data on request.

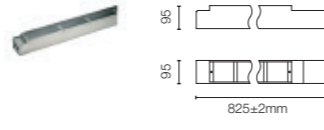
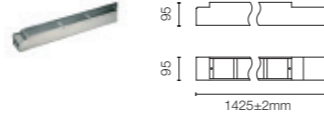

Cielo: Accessori / Accessories

Scatola per incasso.	Box for installation.	Cielo L 645 FA71	
Scatola per incasso.	Box for installation.	Cielo L 1245 FA72	
Telaio per controsoffitto.	Frame for recessed installation in the ceiling	Cielo L 645 FA81	
Telaio per controsoffitto.	Frame for recessed installation in the ceiling	Cielo L 1245 FA82	

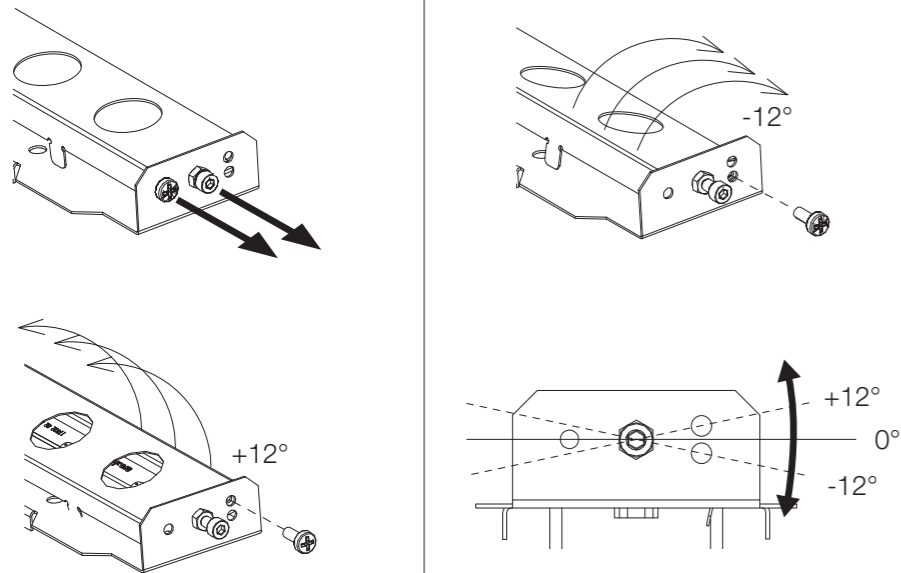
Adjustability LED

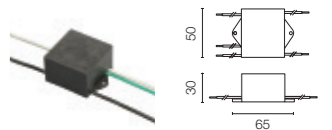
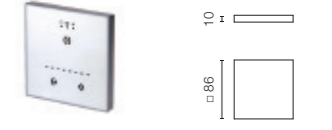
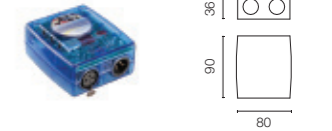
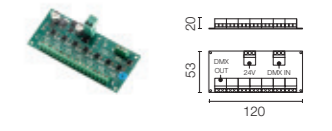

Cielo: Accessori / Accessories

Dispositivo di protezione per il sovraccarico. 275 Vac. Corrente massima di scarica 10KA (8/29us). Massima corrente operativa 5A. Adatto per la connessione in serie. IP66.	Surge protection device. 275Vac. Maximum discharge current 10KA (8/20us). Maximum operating current 5A. Suitable for series connection. IP66.	F990E00A000	
Controller DMX a parete per scatole ad incasso (60mm interasse fori).	DMX controller; dimmer switch for recessed box (60mm hole centres).	F990B10A000	
Controller DMX stand-alone/interfaccia pc.	DMX controller; stand-alone/pc interface.	F990B11A000	
DMX splitter 512 - dispositivo elettronico per rigenerare segnale dmx monodirezionale 1 Input e 7 output, 12-24Vdc. Alimentatore non incluso.	DMX splitter 512 - electronic device to regenerate the monodirectional DMX signal 1 Input and 7 output, 12-24Vdc. Power supply not included.	F990B13A000	
Cavo DMX schermato con impedenza costante 110 Ohm.	DMX cable - shielded twisted pair with 110 Ohm constant impedance.	F990B12A000	

Eclipse

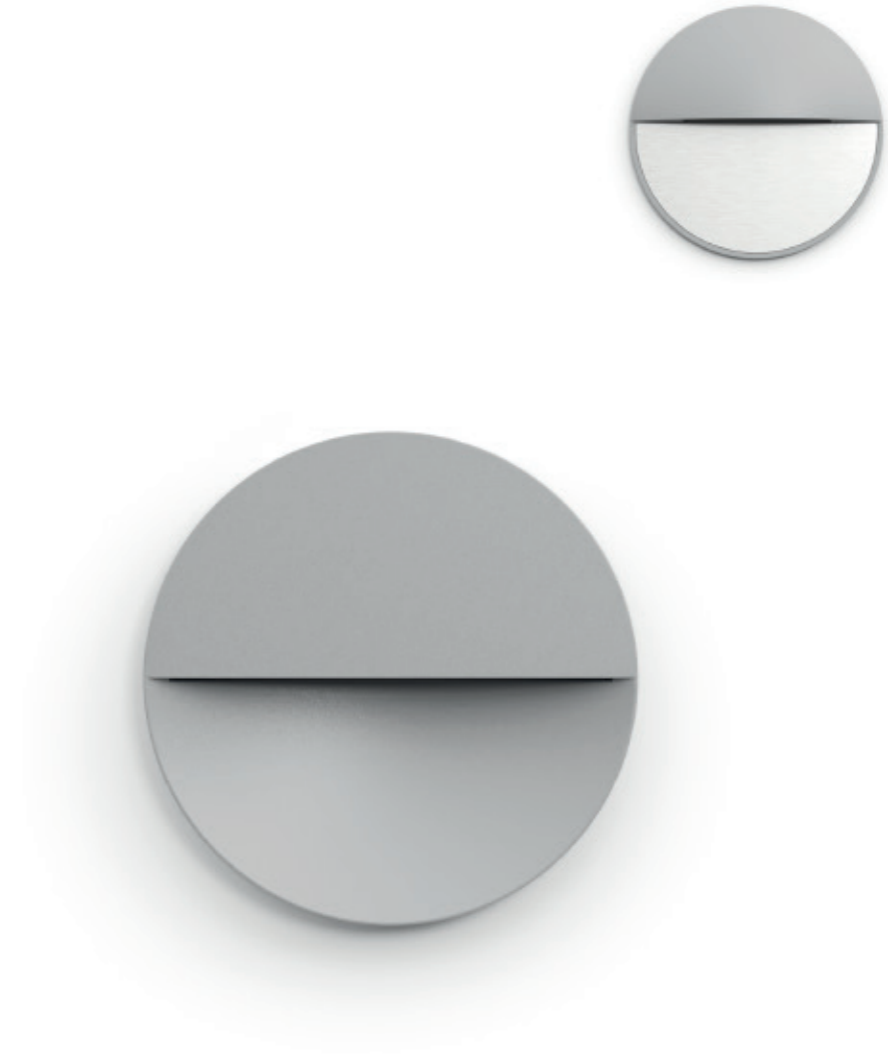

Eclipse

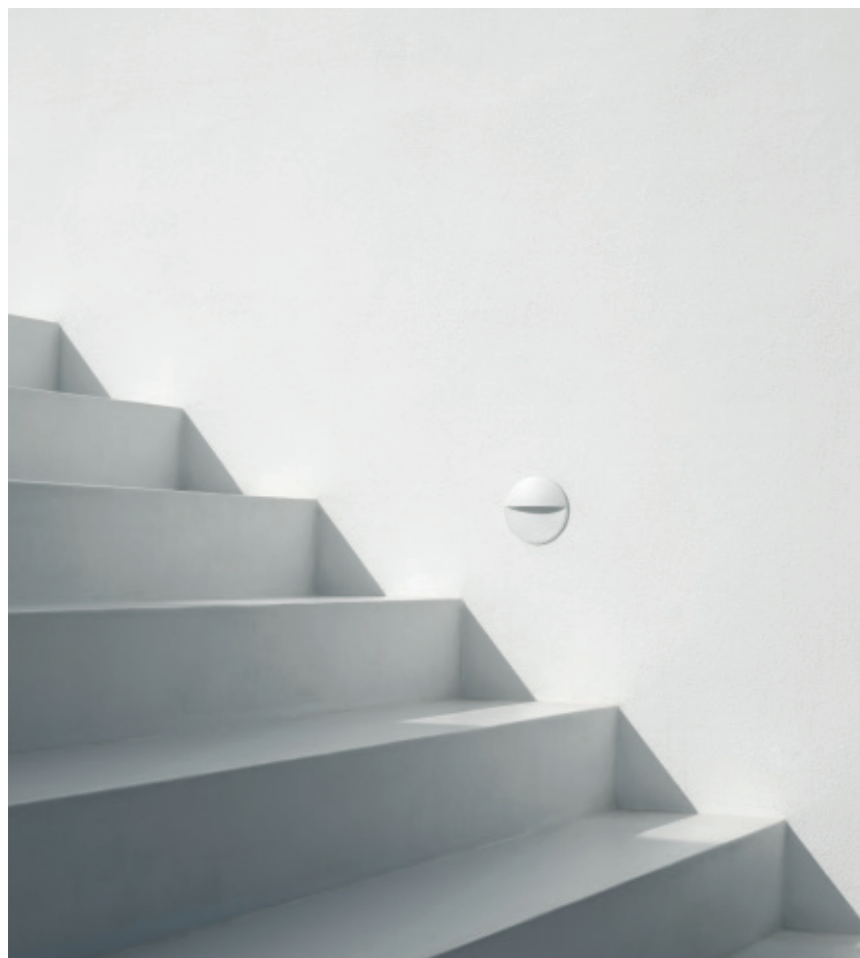

Famiglia / Family

Eclipse



Mid-Power Led

up to 10W
up to 387 lm - 2700K/CRI 80
up to 416 lm - 3000K/CRI 80
up to 437 lm - 4000K/CRI 80

* Net lumen output

Mid-Power Led

up to 7,5W
up to 387 lm - 2700K/CRI 80
up to 416 lm - 3000K/CRI 80
up to 437 lm - 4000K/CRI 80

* Net lumen output

Eclipse Mini



Low-Power Led

up to 1,9W
up to 66 lm - 2700K/CRI 80
up to 71 lm - 3000K/CRI 80
up to 74 lm - 4000K/CRI 80

* Net lumen output

Descrizione / Description

Famiglia di apparecchi di illuminazione segnapasso a parete con sorgente luminosa a LED, caratterizzati dal ridotto spessore e dalla forma circolare declinata in due dimensioni. Disponibili in differenti finiture con rivestimento a doppio strato di polveri e sottoposte a trattamento di conversione chimica superficiale per una elevata resistenza alla corrosione. Le viterie di fissaggio sono in acciaio inox AISI 316L.

Eclipse

Apparecchio circolare di diametro maggiore per installazione a parete. Disponibile in versione con alimentatore incorporato e versione con alimentatore remoto a 24Vdc da ordinare separatamente. Corpo dell'apparecchio in alluminio pressofuso lega EN AB 47100 (a basso contenuto di rame e diffusore in policarbonato trasparente sagomato. L'apparecchio è dotato di uno spezzone di cavo in neoprene per una facile connessione. Fissaggio diretto sulla superficie mediante la staffa in acciaio inox inclusa.

Eclipse Mini

Apparecchio circolare di diametro minore per installazione a parete. Corpo dell'apparecchio in alluminio pressofuso lega EN AB 47100 (a basso contenuto di rame e diffusore in policarbonato trasparente sagomato. Schermo riflettente in alluminio satinato applicato mediante biadesivo in dotazione. L'apparecchio è dotato di uno spezzone di cavo in neoprene per una facile connessione.

Apparecchio in 24V dc, necessita di alimentatore remoto da ordinare separatamente. Fissaggio diretto sulla superficie o mediante scatola da incasso da ordinare separatamente, compatibile con scatola elettrica 3 moduli 503, in cui è possibile anche alloggiare l'alimentatore remoto 24Vdc.

Family of wall mounted path lights with LED source. Defined by their reduced thickness and round shape. They're available in two dimensions and different finishes, with double-layered powder coating and chemical conversion surface treatment to ensure high corrosion resistance. The fixing screws are made of stainless steel AISI 316L.

Eclipse

Big round luminaire for wall mounting. Available with integrated power supply or remote 24V dc power supply that needs to be ordered separately. EN AB-47100 die cast aluminum body (with low copper content) and transparent profiled polycarbonate diffuser. It's completed with a neoprene cable section to ease the connection. Direct attachment on the surface with an included stainless steel bracket.

Eclipse Mini

Small round luminaire for wall mounting. EN AB-47100 die cast aluminum body (with low copper content) and transparent profiled polycarbonate diffuser. It's completed with a neoprene cable section to ease the connection. The 24V dc luminaire needs a remote power supply that needs to be ordered separately. Direct attachment on the surface or with a recessed box that needs to be ordered separately. Compatible with the three-module electrical junction box, model 503, where the remote 24V dc power supply can be installed.

Colori / Colours



01 White



06 Grey



12 Forest Green

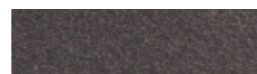

18 Deep Brown



30 Black



33 Anthracite

Eclipse

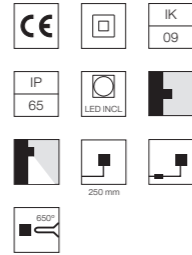
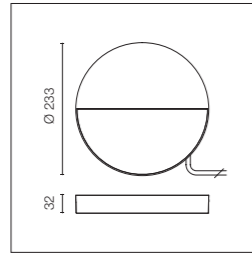

Eclipse 230V
Sorgente a LED inclusa.
Alimentazione elettrica 220-240V ON/ OFF. Dotato di spezzone di cavo uscente in neoprene 200 mm e kit con connettori crimp e guaina termorestringente adesiva per connessione a tenuta stagna.

Eclipse 230V
LED source included. Electrical power supply 220-240V ON/ OFF. Equipped with a 200mm protruding section of neoprene cable and a kit with crimpable connectors and adhesive heat-shrinkable sleeves that guarantee the tightness of the connection.

Mid - Power Led: 10W - 739 lm ≠ OUTPUT 387 lm - 2700K/CRI 80 - 220÷240V / 10W - 795 lm ≠ OUTPUT 416 lm - 3000K/CRI 80 - 220÷240V / 10W - 835 lm ≠ OUTPUT 437 lm - 4000K/CRI 80 - 220÷240V

2700K

- FA54200701
- FA54200706
- FA54200712
- FA54200718
- FA54200730
- FA54200733

3000K

- FA54200301
- FA54200306
- FA54200312
- FA54200318
- FA54200330
- FA54200333

4000K

- FA54200201
- FA54200206
- FA54200212
- FA54200218
- FA54200230
- FA54200233

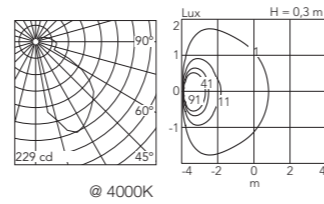

Eclipse

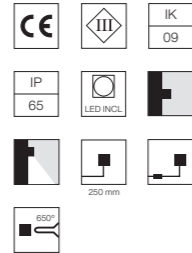
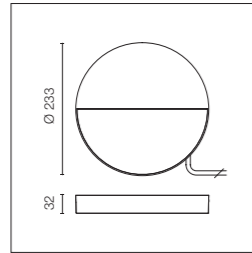

Sorgente a LED inclusa.
Alimentazione elettrica remota 24V dc da ordinare separatamente. Dotato di spezzone di cavo uscente in neoprene 300 mm e kit con connettori crimp e guaina termorestringente adesiva per connessione a tenuta stagna. Dimmerabile.

LED source included. Remote electrical power supply 24V dc to be ordered separately. Equipped with a 300mm protruding section of neoprene cable and a kit with crimpable connectors and adhesive heat-shrinkable sleeves that guarantee the tightness of the connection. Dimmable.

Mid - Power Led: 7,5W - 739 lm ≠ OUTPUT 387 lm - 2700K/CRI 80 - 24Vdc / 7,5W - 795 lm ≠ OUTPUT 416 lm - 3000K/CRI 80 - 24Vdc / 7,5W - 835 lm ≠ OUTPUT 437 lm - 4000K/CRI 80 - 24Vdc

2700K

- FA54200901
- FA54200906
- FA54200912
- FA54200918
- FA54200930
- FA54200933

3000K

- FA54200601
- FA54200606
- FA54200612
- FA54200618
- FA54200630
- FA54200633

4000K

- FA54200501
- FA54200506
- FA54200512
- FA54200518
- FA54200530
- FA54200533

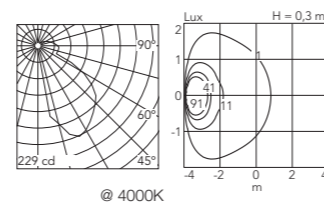

Eclipse Mini

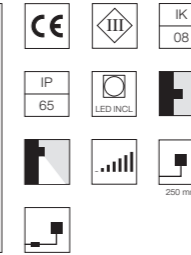
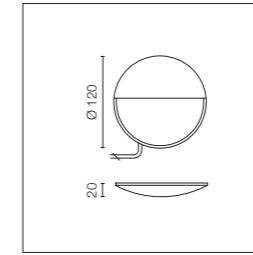

Sorgente a LED inclusa.
Completo di schermo riflettente. Alimentazione elettrica remota 24V dc da ordinare separatamente. Cassaforma opzionale da ordinare separatamente (scatola elettrica 3 moduli 503). Dotato di spezzone di cavo uscente in neoprene 250 mm e kit con connettori crimp e guaina termorestringente adesiva per connessione a tenuta stagna. Dimmerabile.

LED source included.
Completed with a reflective screen. Remote electrical power supply 24V dc to be ordered separately. Optional electrical junction box (three modules, model 503) to be ordered separately. Equipped with a 250 mm protruding section of neoprene cable and a kit with crimpable connectors and adhesive heat-shrinkable sleeves that guarantee the tightness of the connection. Dimmable.

Low - Power Led: 1,9W - 139 lm ≠ OUTPUT 66 lm - 2700K/CRI 80 - 24Vdc / 1,9W - 149 lm ≠ OUTPUT 71 lm - 3000K/CRI 80 - 24Vdc / 1,9W - 156 lm ≠ OUTPUT 74 lm - 4000K/CRI 80 - 24Vdc

2700K

- FA52600501
- FA52600506
- FA52600512
- FA52600518
- FA52600530
- FA52600533

3000K

- FA52600301
- FA52600306
- FA52600312
- FA52600318
- FA52600330
- FA52600333

4000K

- FA52600201
- FA52600206
- FA52600212
- FA52600218
- FA52600230
- FA52600233

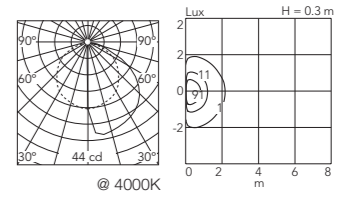

* Numero massimo di apparecchi per alimentatore / Maximum number of luminaires per power supply.

Numero massimo di apparecchi per alimentatore (Vin220÷240). Dati indicativi da verificare con le specifiche condizioni di installazione.	Maximum number of luminaires per power supply. (220÷240 V). These data must be checked taking into account the specific installation conditions.	Acc. RF25754	3	Acc. RF26387	9
		Acc. RF25748	3	Acc. RF25752	9
		Acc. RF25747	5	Acc. RF25755	25
		Acc. RF25757	5	Acc. RF25749	30
		Acc. RF25750	8	Acc. RF25756	45
		Acc. F990B21A000	8		

* Numero massimo di apparecchi per alimentatore / Maximum number of luminaires per power supply.

Numero massimo di apparecchi per alimentatore (Vin220÷240). Dati indicativi da verificare con le specifiche condizioni di installazione.	Maximum number of luminaires per power supply. (220÷240 V). These data must be checked taking into account the specific installation conditions.	Acc. RF25747	1	Acc. RF25752	2
		Acc. RF25757	1	Acc. RF25755	6
		Acc. RF25750	2	Acc. RF25749	9
		Acc. F990B21A000	2	Acc. RF25756	12
		Acc. RF26387	2		

Eclipse: Accessori / Accessories

Dispositivo di protezione per il sovraccarico. 275Vac. Corrente massima di scarica 10KA (8/29µs). Massima corrente operativa 5A. Adatto per la connessione in serie. IP66.

Surge protection device. 275Vac. Maximum discharge current 10KA (8/20µs). Maximum operating current 5A. Suitable for series connection. IP66.

Eclipse
F990E00A000

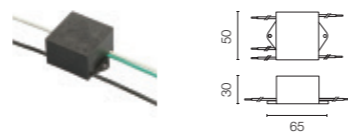

Scatola di derivazione da incasso 3 moduli (modello 503)

Recessed 3-module junction box (model 503)

Eclipse Mini
F990H010000

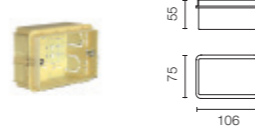

Recessed installation Eclipse Mini

Opzionale:
Alimentatore art. RF25748.

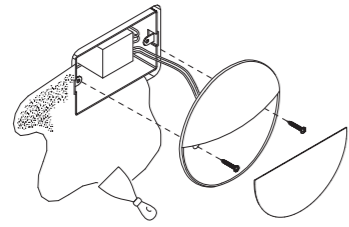

Wall installation Eclipse Mini

Optional:
Power supply code RF25748.

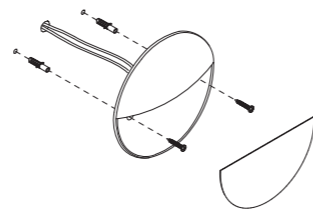

Eclipse: Driver/ Drivers

Alimentatore 24V 10W / 110-240V IP20 Classe II selv.

Power supply 24V 10W / 110-240V IP20 Class II selv.

*RF25747



Alimentatore 24V 10W / 110-240V IP67 Classe II selv.

Power supply 24V 10W / 110-240V IP67 Class II selv.

*RF25757

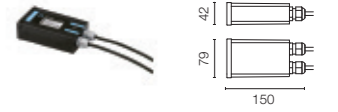

Alimentatore per installazione remota 24Vdc 17W / 110-240V (15W@110V) IP20 Classe II selv.

Power supply for remote installation 24Vdc 17W / 110-240V (15W@110V) IP20 Class II selv.

*RF25750

Dimmable Push-Dim Or 1-10V
See Wiring Diagram n.4. Page 668.

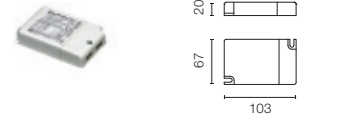

Alimentatore 17W/110÷240V - 24Vdc (15W@110V) IP67 Classe II Selv.

Power supply 17W/110÷240V - 24Vdc (15W@110V) IP67 Class II Selv.

*F990B21A000

Dimmable Push-Dim Or 1-10V
See Wiring Diagram n.4. Page 668.

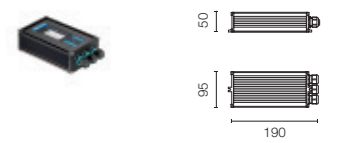

Alimentatore per installazione remota 24Vdc 20W / 110-240Vdc (15W@110V) IP67 Classe II selv.

Power supply for remote installation 24Vdc 20W / 110-240Vdc (15W@110V) IP67 Class II selv.

*RF26387

Dimmable DALI
See Wiring Diagram n.4. Page 668.

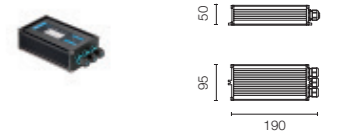

Alimentatore per installazione remota 24Vdc 20W / 220-240V IP67 Classe II selv.

Power supply for remote installation 24Vdc 20W / 220-240V IP67 Class II selv.

*RF25752



Alimentatore 24Vdc 35W / 120-270V IP67 Classe II selv.

Power supply 24Vdc 35W / 120-270V IP67 Class II selv.

F990B23AZ00

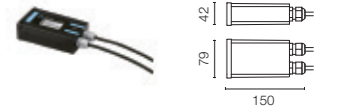

Alimentatore per installazione remota 24Vdc 50W / 120-240V IP67 Classe II selv.

Power supply for remote installation 24Vdc 50W / 120-240V IP67 Class II selv.

*RF25755

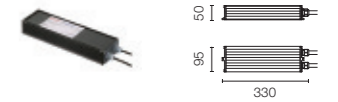

Alimentatore per installazione remota 24Vdc 70W / 220-240V IP67 Classe II selv.

Power supply for remote installation 24Vdc 70W / 220-240V IP67 Class II selv.

*RF25749



Alimentatore per installazione remota 24Vdc 96W / 120-240V IP67 Classe II selv.

Power supply for remote installation 24Vdc 96W / 120-240V IP67 Class II selv.

*RF25756

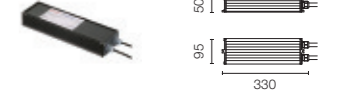

Alimentatore doppia funzione Vout 24Vdc: 8W/100÷240V Iout 350ma: 6x1W/100÷240V IP20 Classe II Selv Eq.

Power supply dual function Vout 24Vdc: 8W/100÷240V Iout 350ma: 6x1W/100÷240V IP20 Class II Selv Eq.

Eclipse Mini

*RF25754

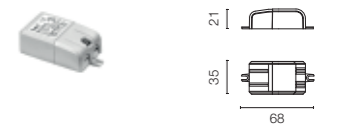

Alimentatore 24V 8W / 110-240V IP65 Classe II selv.

Power supply 24V 8W / 110-240V IP65 Class II selv.

Eclipse Mini

*RF25748



Hyperion

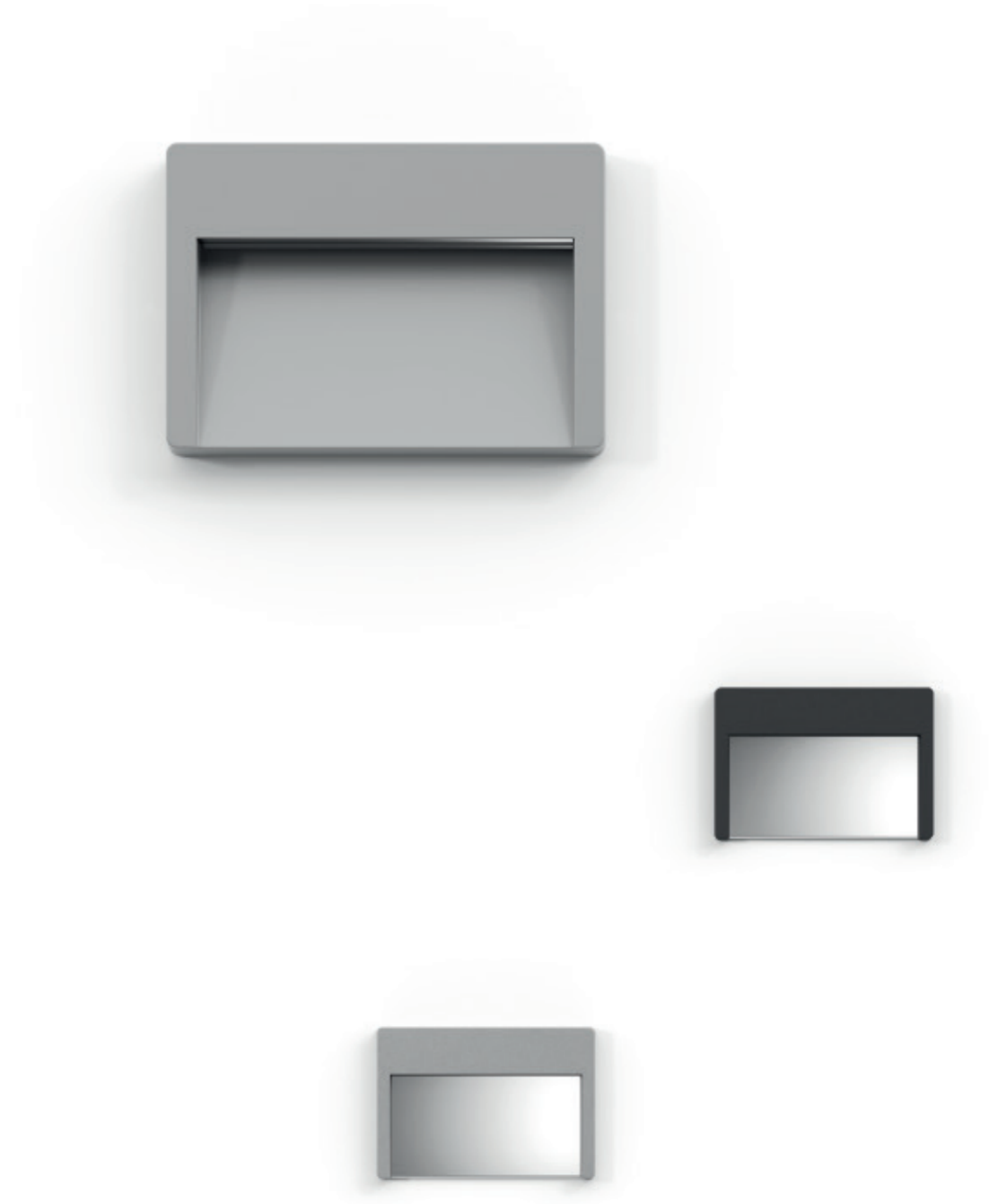



Famiglia / Family

Hyperion



Mid-Power Led

up to 10W
up to 401 lm - 2700K/CRI 80
up to 428 lm - 3000K/CRI 80
up to 442 lm - 4000K/CRI 80
* Net lumen output

Mid-Power Led

up to 7,5W
up to 370 lm - 2700K/CRI 80
up to 398 lm - 3000K/CRI 80
up to 418 lm - 4000K/CRI 80
* Net lumen output

Hyperion Mini



Low-Power Led

up to 1,9W
up to 57 lm - 2700K/CRI 80
up to 61 lm - 3000K/CRI 80
up to 64 lm - 4000K/CRI 80
* Net lumen output

Descrizione / Description

Famiglia di apparecchi di illuminazione segnapasso a parete con sorgente luminosa a LED, caratterizzati dal ridotto spessore e dalla forma rettangolare declinata in due dimensioni. Disponibili in differenti finiture con rivestimento a doppio strato di polveri e sottoposte a trattamento di conversione chimica superficiale per una elevata resistenza alla corrosione. Le viterie di fissaggio sono in acciaio inox AISI 316L.

Hyperion

Apparecchio rettangolare di dimensione maggiore dal ridotto spessore per installazione a parete. Disponibile in versione con alimentatore incorporato e versione con alimentatore remoto a 24Vdc da ordinare separatamente. Corpo dell'apparecchio in alluminio pressofuso lega EN AB 47100 (a basso contenuto di rame e diffusore in policarbonato trasparente sagomato). L'apparecchio è dotato di uno spezzone di cavo in neoprene per una facile connessione. Fissaggio diretto sulla superficie mediante la staffa in acciaio inox inclusa.

Disponibili accessori opzionali riflettore e palo. Il riflettore in alluminio satinato garantisce un aumento del flusso emesso di circa 20% e viene fissato al corpo mediante biadesivo in dotazione. Il palo estruso viene utilizzato per il posizionamento dell'apparecchio come bollard. Il palo può essere installato facilmente a terra su qualsiasi pavimento con tasselli, oppure utilizzando l'accessorio dedicato piastra di ancoraggio e tirafondi per rendere la base del prodotto totalmente solidale con la pavimentazione.

Hyperion Mini

Apparecchio rettangolare di dimensione minore per installazione a parete. Corpo dell'apparecchio in alluminio pressofuso lega EN AB 47100 (a basso contenuto di rame e diffusore in policarbonato trasparente sagomato). Schermo riflettente in alluminio satinato applicato mediante biadesivo in dotazione. L'apparecchio è dotato di uno spezzone di cavo in neoprene per una facile connessione.

Apparecchio in 24V dc, necessita di alimentatore remoto da ordinare separatamente. Fissaggio diretto sulla superficie o mediante scatola da incasso da ordinare separatamente, compatibile con scatola elettrica 3 moduli 503, in cui è possibile anche alloggiare l'alimentatore remoto 24Vdc.

Family of wall mounted path lights with LED source. Defined by their reduced thickness and rectangular shape. They're available in two dimensions and different finishes, with double-layered powder coating and chemical conversion surface treatment to ensure high corrosion resistance. The fixing screws are made of stainless steel AISI 316L.

Hyperion

Big rectangular luminaire with reduced thickness for wall mounting. Available with integrated power supply or remote 24V dc power supply that needs to be ordered separately. EN AB-47100 die cast aluminum body (with low copper content) and transparent molded polycarbonate diffuser. It's completed with a neoprene cable section to ease the connection. Direct attachment on the surface with an included stainless steel bracket. Optional accessories available: reflector and post. The satin aluminum reflector increases the luminous flux by approximately 20% and is attached to the body with the double-sided adhesive provided. The extruded post is used to install the luminaire as a bollard. The post is easily installed on any floor surface by means of dowels or the specific accessory anchor plate and lag screws that secure the luminaire solidly to the pavement.

Hyperion Mini

Small rectangular luminaire for wall mounting. EN AB-47100 die cast aluminum body (with low copper content) and transparent molded polycarbonate diffuser. Reflective satin aluminum screen that is attached with the double-sided adhesive provided. With a neoprene cable section to ease the connection. The 24V luminaire needs a remote power supply that needs to be ordered separately. Direct attachment on the surface or with a recessed box that needs to be ordered separately. Compatible with the three module electrical junction box, model 503, where the remote 24V dc power supply can be installed.

Colori / Colours



01 White



06 Grey



12 Forest Green

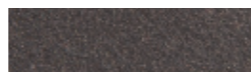

18 Deep Brown



30 Black

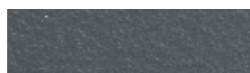

33 Anthracite

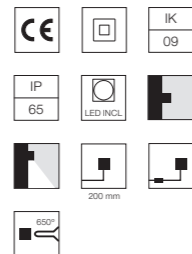
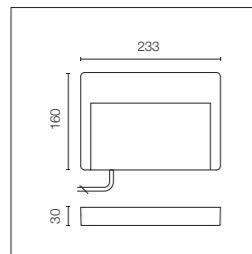

Hyperion 230V. Sorgente a LED inclusa. Alimentazione elettrica 220-240V ON/ OFF. Dotato di spezzone di cavo uscente in neoprene 200 mm e kit con connettori crimp e guaina termorestringente adesiva per connessione a tenuta stagna. Accessori opzionali: riflettore in alluminio satinato per aumento del flusso; palo estruso h 500 mm per versione bollard. Piastra di ancoraggio per l'installazione in gettata da ordinare separatamente.

Hyperion 230V. LED source included. Electrical power supply 220-240V ON/ OFF. Equipped with a 200 mm protruding section of neoprene cable and a kit with crimpable connectors and adhesive heat-shrinkable sleeves that guarantee the tightness of the connection. Optional accessories: satin aluminum reflector to increase the luminous flux; 500mm tall, extruded post for the bollard version. Anchor plate to be recessed with mortar needs to be ordered separately.

Mid - Power Led: 10W - 739 lm ≠ OUTPUT 401 lm - 2700K/CRI 80 - 220÷240V / 10W - 795 lm ≠ OUTPUT 428 lm - 3000K/CRI 80 - 220÷240V / 10W - 835 lm ≠ OUTPUT 442 lm - 4000K/CRI 80 - 220÷240V

2700K

- FA52700501
- FA52700506
- FA52700512
- FA52700518
- FA52700530
- FA52700533

3000K

- FA52700301
- FA52700306
- FA52700312
- FA52700318
- FA52700330
- FA52700333

4000K

- FA52700201
- FA52700206
- FA52700212
- FA52700218
- FA52700230
- FA52700233

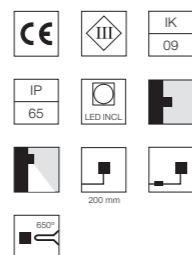
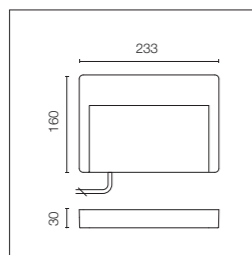
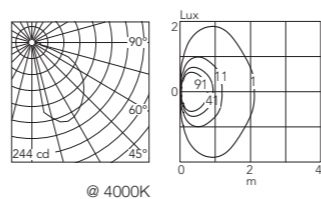

Sorgente a LED inclusa. Alimentazione elettrica remota 24V dc da ordinare separatamente. Dotato di spezzone di cavo uscente in neoprene 300 mm e kit con connettori crimp e guaina termorestringente adesiva per connessione a tenuta stagna. Accessori opzionali: riflettore in alluminio satinato per aumento del flusso; palo estruso h 500 mm per versione bollard. Piastra di ancoraggio per l'installazione in gettata da ordinare separatamente. Dimmerabile.

LED source included. Remote electrical power supply 24V dc to be ordered separately. Equipped with a 300 mm protruding section of neoprene cable and a kit with crimpable connectors and adhesive heat-shrinkable sleeves that guarantee the tightness of the connection. Optional accessories: satin aluminum reflector to increase the luminous flux; 500mm tall, extruded post for the bollard version. Anchor plate to be recessed with mortar needs to be ordered separately. Dimmable.

Mid - Power Led: 7,5W - 739 lm ≠ OUTPUT 401 lm - 2700K/CRI 80 - 24Vdc / 7,5W - 795 lm ≠ OUTPUT 428 lm - 3000K/CRI 80 - 24Vdc / 7,5W - 835 lm ≠ OUTPUT 442 lm - 4000K/CRI 80 - 24Vdc

2700K

- FA52701501
- FA52701506
- FA52701512
- FA52701518
- FA52701530
- FA52701533

3000K

- FA52701301
- FA52701306
- FA52701312
- FA52701318
- FA52701330
- FA52701333

4000K

- FA52701201
- FA52701206
- FA52701212
- FA52701218
- FA52701230
- FA52701233

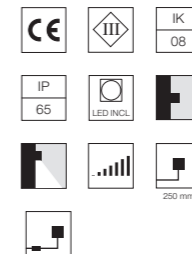
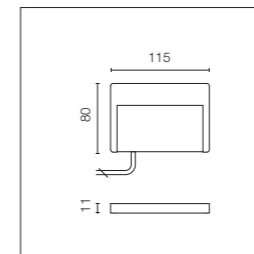
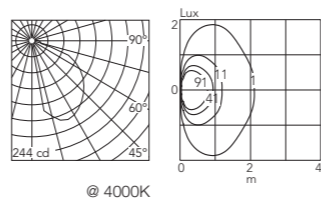

Sorgente a LED inclusa. Completo di schermo riflettente. Alimentazione elettrica remota 24V dc da ordinare separatamente. Cassaforma opzionale da ordinare separatamente (scatola elettrica 3 moduli 503). Dotato di spezzone di cavo uscente in neoprene 250 mm e kit con connettori crimp e guaina termorestringente adesiva per connessione a tenuta stagna. Dimmerabile.

LED source included. Completed with a reflective screen. Remote electrical power supply 24V dc to be ordered separately. Optional junction box to be ordered separately (3 module electrical box, model 503). Equipped with a 250 mm protruding section of neoprene cable and a kit with crimpable connectors and adhesive heat-shrinkable sleeves that guarantee the tightness of the connection. Dimmable.

Low - Power Led: 1,9W - 139 lm ≠ OUTPUT 57 lm - 2700K/CRI 80 - 24Vdc / 1,9W - 149 lm ≠ OUTPUT 61 lm - 3000K/CRI 80 - 24Vdc / 1,9W - 156 lm ≠ OUTPUT 64 lm - 4000K/CRI 80 - 24Vdc

2700K

- FA102960001
- FA102960006
- FA102960012
- FA102960018
- FA102960030
- FA102960033

3000K

- FA102950001
- FA102950006
- FA102950012
- FA102950018
- FA102950030
- FA102950033

4000K

- FA1022290001
- FA1022290006
- FA1022290012
- FA1022290018
- FA1022290030
- FA1022290033

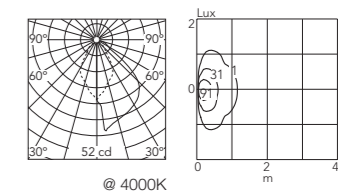

* Numero massimo di apparecchi per alimentatore / Maximum number of luminaires per power supply.

Numero massimo di apparecchi per alimentatore (Vin220÷240). Dati indicativi da verificare con le specifiche condizioni di installazione.	Maximum number of luminaires per power supply. (220÷240 V). These data must be checked taking into account the specific installation conditions.	Acc. RF25754	3	Acc. RF26387	9
		Acc. RF25748	3	Acc. RF25752	9
		Acc. RF25747	5	Acc. RF25755	25
		Acc. RF25757	5	Acc. RF25749	30
		Acc. RF25750	8	Acc. RF25756	45
		Acc. F990B21A000	8		

* Numero massimo di apparecchi per alimentatore / Maximum number of luminaires per power supply.

Numero massimo di apparecchi per alimentatore (Vin220÷240). Dati indicativi da verificare con le specifiche condizioni di installazione.	Maximum number of luminaires per power supply. (220÷240 V). These data must be checked taking into account the specific installation conditions.	Acc. RF25747	1	Acc. RF25752	2
		Acc. RF25757 <td>1 <td>Acc. RF25755 <td>6 </td></td></td>	1 <td>Acc. RF25755 <td>6 </td></td>	Acc. RF25755 <td>6 </td>	6
		Acc. RF25750 <td>2 <td>Acc. RF25749 <td>9 </td></td></td>	2 <td>Acc. RF25749 <td>9 </td></td>	Acc. RF25749 <td>9 </td>	9
		Acc. F990B21A000 <td>2 <td>Acc. RF25756 <td>12 </td></td></td>	2 <td>Acc. RF25756 <td>12 </td></td>	Acc. RF25756 <td>12 </td>	12
		Acc. RF26387 <td>2 <td></td> <td></td> </td>	2 <td></td> <td></td>		

Hyperion: Accessori / Accessories

Dispositivo di protezione per il sovraccarico. 275Vac. Corrente massima di scarica 10KA (8/29µs). Massima corrente operativa 5A. Adatto per la connessione in serie. IP66.

Surge protection device. 275Vac. Maximum discharge current 10KA (8/20µs). Maximum operating current 5A. Suitable for series connection. IP66.

Hyperion
F990E00A000

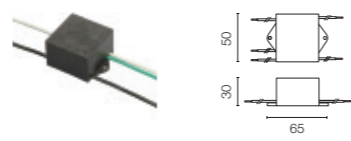

Carter in alluminio satinato spessore 0.5mm.

Satin aluminium carter Thickness 0.5mm.

Hyperion
FA160

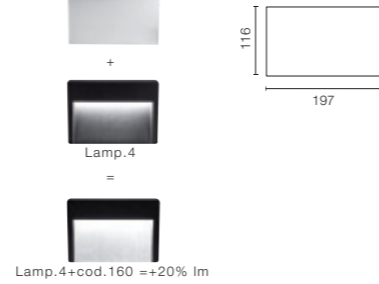

Palo estruso per utilizzo come bollard. Fissaggio diretto con tasselli o con accessorio opzionale piastra tirafondi.

Use of the extruded support as bollard. Direct fixing using studs or a base plate and fixing bolts (optional accessory).

H 500 mm
○ FA24501
● FA24506
● FA24512
● FA24518
● FA24530
● FA24533

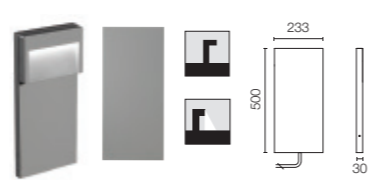

Piastra tirafondi.

Base plate with bolt.

Hyperion
FA247



Scatola di derivazione da incasso 3 moduli (modello 503)

Recessed 3-module junction box (model 503)

Hyperion_Trxie
F990H010000



Recessed installation

Opzionale:
Alimentatore art. RF25748.

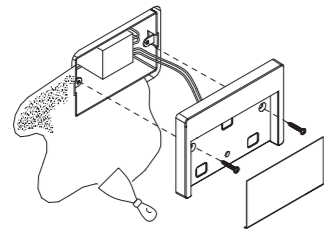

Wall installation

Optional:
Power supply code RF25748.

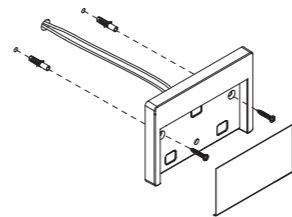

Hyperion: Driver/ Drivers

Alimentatore 24V 10W / 110-240V IP20 Classe II selv.

Power supply 24V 10W / 110-240V IP20 Class II selv.

*RF25747

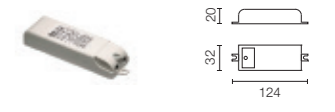

Alimentatore 24V 10W / 110-240V IP67 Classe II selv.

Power supply 24V 10W / 110-240V IP67 Class II selv.

*RF25757

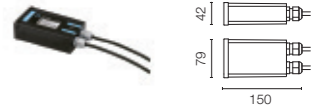

Alimentatore per installazione remota 24Vdc 17W / 110-240V (15W@110V) IP20 Classe II selv.

Power supply for remote installation 24Vdc 17W / 110-240V (15W@110V) IP20 Class II selv.

*RF25750

Dimmable Push-Dim Or 1-10V
See Wiring Diagram n.4. Page 668.

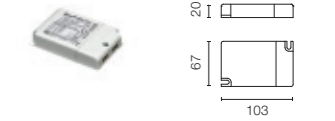

Alimentatore 17W/110÷240V - 24Vdc (15W@110V) IP67 Classe II Selv.

Power supply 17W/110÷240V - 24Vdc (15W@110V) IP67 Class II Selv.

*F990B21A000

Dimmable Push-Dim Or 1-10V
See Wiring Diagram n.4. Page 668.

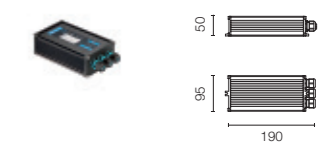

Alimentatore per installazione remota 24Vdc 20W / 110-240Vdc (15W@110V) IP67 Classe II selv.

Power supply for remote installation 24Vdc 20W / 110-240Vdc (15W@110V) IP67 Class II selv.

*RF26387

Dimmable DALI
See Wiring Diagram n.4. Page 668.

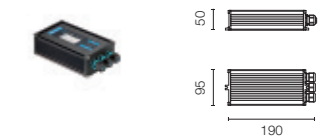

Alimentatore per installazione remota 24Vdc 20W / 220-240V IP67 Classe II selv.

Power supply for remote installation 24Vdc 20W / 220-240V IP67 Class II selv.

*RF25752

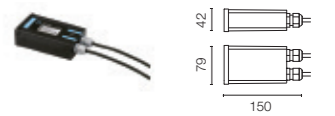

Alimentatore per installazione remota 24Vdc 50W / 120-240V IP67 Classe II selv.

Power supply for remote installation 24Vdc 50W / 120-240V IP67 Class II selv.

*RF25755



Alimentatore per installazione remota 24Vdc 70W / 220-240V IP67 Classe II selv.

Power supply for remote installation 24Vdc 70W / 220-240V IP67 Class II selv.

*RF25749



Alimentatore per installazione remota 24Vdc 96W / 120-240V IP67 Classe II selv.

Power supply for remote installation 24Vdc 96W / 120-240V IP67 Class II selv.

*RF25756

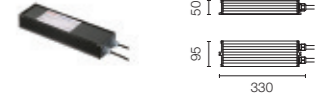

Alimentatore doppia funzione Vout 24Vdc: 8W/100÷240V Iout 350ma: 6x1W/100÷240V IP20 Classe II Selv Eq.

Power supply dual function Vout 24Vdc: 8W/100÷240V Iout 350ma: 6x1W/100÷240V IP20 Class II Selv Eq.

Hyperion Mini
*RF25754

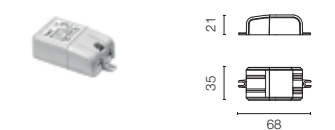

Alimentatore 24V 8W / 110-240V IP65 Classe II selv.

Power supply 24V 8W / 110-240V IP65 Class II selv.

Hyperion Mini
*RF25748



Platter

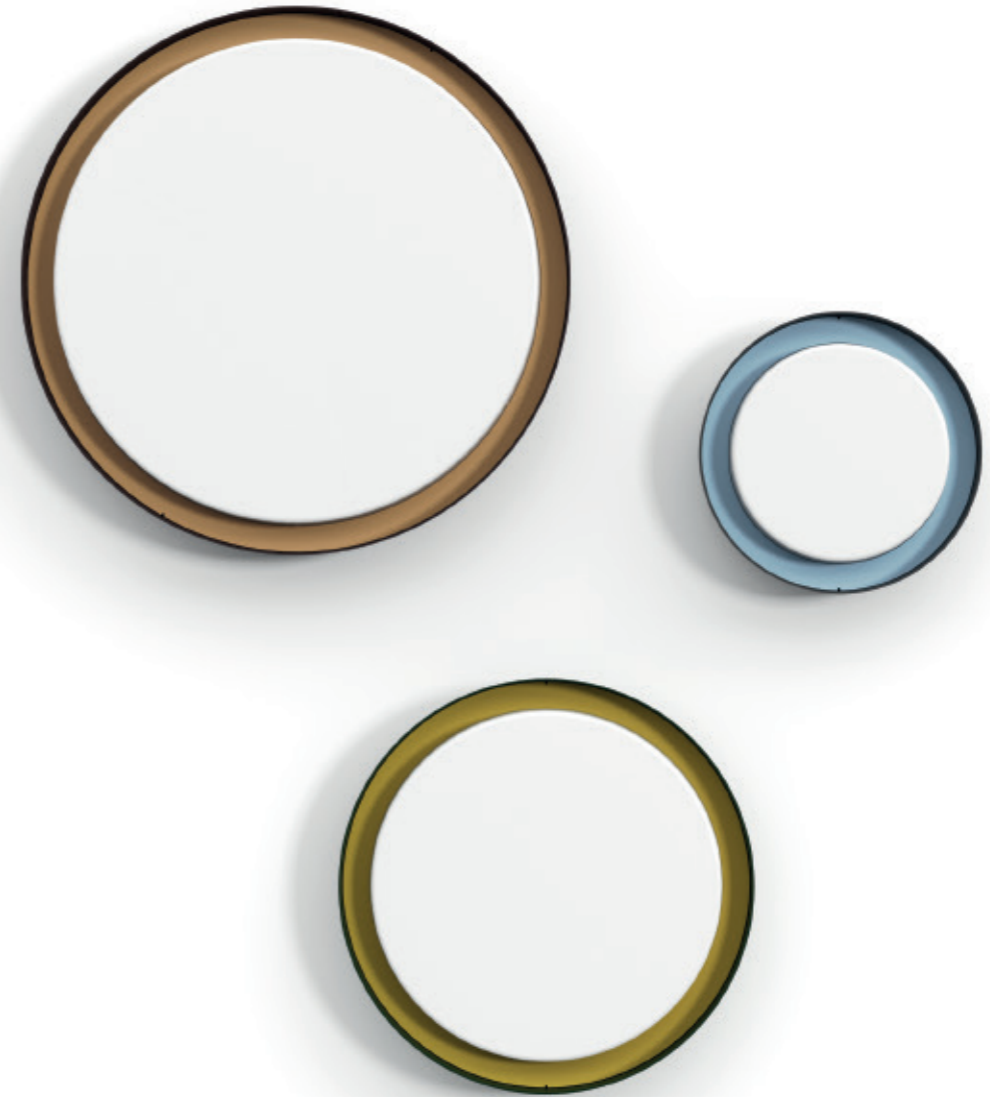

Platter



Famiglia / Family

Platter 410



Mid-Power Led

up to 34W
 up to 2345 lm - 2700K/CRI 80
 up to 2521 lm - 3000K/CRI 80
 up to 2712 lm - 4000K/CRI 80

* Net lumen output

Platter 310



Mid-Power Led

up to 18W
 up to 1150 lm - 2700K/CRI 80
 up to 1237 lm - 3000K/CRI 80
 up to 1330 lm - 4000K/CRI 80

* Net lumen output

Platter 210



Mid-Power Led

up to 11W
 up to 732 lm - 2700K/CRI 80
 up to 787 lm - 3000K/CRI 80
 up to 812 lm - 4000K/CRI 80

* Net lumen output

Descrizione / Description

Famiglia di apparecchi di illuminazione per installazione a parete e soffitto, caratterizzati dalla forma circolare declinata in tre dimensioni. Il diffusore in materiale plastico opalino garantisce una elevata uniformità di emissione luminosa. Piastra di fissaggio posteriore in alluminio pressofuso lega EN AB 47100 (a basso contenuto di rame), struttura e dissipatore del calore in alluminio tornito. Cornice estetica di chiusura magnetica per nascondere le viti di fissaggio, in acciaio inox AISI 316L. Disponibili in differenti finiture con rivestimento a doppio strato di polveri e sottoposte a trattamento di conversione chimica superficiale per una elevata resistenza alla corrosione.

Family of wall or ceiling mounted luminaires. Defined by their round shape. Available in three dimensions. Diffuser made of opal plastic material that guarantees high uniformity in light emission. EN AB-47100 die-cast mounting plate (with low copper content), turned aluminum structure and heat sinks. Magnetic closing frame to hide the AISI 316L stainless steel fixing screws. Available in different finishes, with double-layered powder coating and chemical conversion surface treatment to ensure high corrosion resistance.

Colori / Colours



01 White



06 Grey



12 Forest Green



18 Deep Brown



30 Black



33 Anthracite



Grey / Brown Brick



Anthracite / Pale Blue



Deep Brown / Pale Brown



Forest Green / Oliva Green

Platter 410

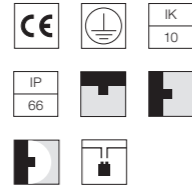
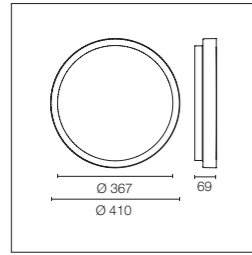

Sorgente a LED inclusa. Alimentazione elettrica 220-240V ON/ OFF e dimmerabile 1-10V o DALI integrata. Dotata di passacavo IP65, per cavi in gomma 5mm< ϕ <10mm e una morsettiere a 2 poli a connessione rapida. Per garantire la tenuta del passacavo è consigliabile utilizzare cavi elettrici flessibili idonei all'impiego in ambienti esterni.

LED source included. Integrated power supply 220-240V ON/OFF and dimmable 1-10V or DALI. With IP65 cable guide for rubber cables 5mm< ϕ <10mm and a 2-pole connection box for a fast connection. To ensure the tightness of the cable guide it's recommended to use flexible electric cables suitable for exterior use.

Mid-Power Led: 34W - 3590 lm \neq OUTPUT 2345 lm - 2700K/CRI 80 - 220 \pm 240V / 34W - 3860 lm \neq OUTPUT 2521 lm - 3000K/CRI 80 - 220 \pm 240V / 34W - 4152 lm \neq OUTPUT 2712 lm - 4000K/CRI 80 - 220 \pm 240V

- | | | |
|--|--|--|
| <p>2700K
Non Dimmable</p> <ul style="list-style-type: none"> ○ FA53305201 ● FA53305206 ● FA53305212 ● FA53305218 ● FA53305230 ● FA53305233 <p>1-10V</p> <ul style="list-style-type: none"> ○ FA53305201-310 ● FA53305206-310 ● FA53305212-310 ● FA53305218-310 ● FA53305230-310 ● FA53305233-310 <p>Dali</p> <ul style="list-style-type: none"> ○ FA53305201-300 ● FA53305206-300 ● FA53305212-300 ● FA53305218-300 ● FA53305230-300 ● FA53305233-300 | <p>3000K
Non Dimmable</p> <ul style="list-style-type: none"> ○ FA53302201 ● FA53302206 ● FA53302212 ● FA53302218 ● FA53302230 ● FA53302233 <p>1-10V</p> <ul style="list-style-type: none"> ○ FA53302201-310 ● FA53302206-310 ● FA53302212-310 ● FA53302218-310 ● FA53302230-310 ● FA53302233-310 <p>Dali</p> <ul style="list-style-type: none"> ○ FA53302201-300 ● FA53302206-300 ● FA53302212-300 ● FA53302218-300 ● FA53302230-300 ● FA53302233-300 | <p>4000K
Non Dimmable</p> <ul style="list-style-type: none"> ○ FA53302101 ● FA53302106 ● FA53302112 ● FA53302118 ● FA53302130 ● FA53302133 <p>1-10V</p> <ul style="list-style-type: none"> ○ FA53302101-310 ● FA53302106-310 ● FA53302112-310 ● FA53302118-310 ● FA53302130-310 ● FA53302133-310 <p>Dali</p> <ul style="list-style-type: none"> ○ FA53302101-300 ● FA53302106-300 ● FA53302112-300 ● FA53302118-300 ● FA53302130-300 ● FA53302133-300 |
|--|--|--|

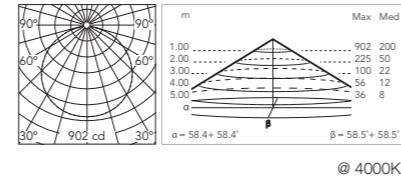

Platter 410 Grey / Brown Brick

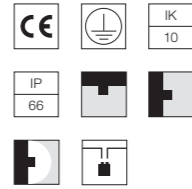
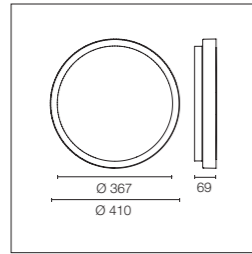

Sorgente a LED inclusa. Alimentazione elettrica 220-240V ON/ OFF e dimmerabile 1-10V o DALI integrata. Dotata di passacavo IP65, per cavi in gomma 5mm< ϕ <10mm e una morsettiere a 2 poli a connessione rapida. Per garantire la tenuta del passacavo è consigliabile utilizzare cavi elettrici flessibili idonei all'impiego in ambienti esterni.

LED source included. Integrated power supply 220-240V ON/OFF and dimmable 1-10V or DALI. With IP65 cable guide for rubber cables 5mm< ϕ <10mm and a 2-pole connection box for a fast connection. To ensure the tightness of the cable guide it's recommended to use flexible electric cables suitable for exterior use.

Mid-Power Led: 34W - 3590 lm \neq OUTPUT 2345 lm - 2700K/CRI 80 - 220 \pm 240V / 34W - 3860 lm \neq OUTPUT 2521 lm - 3000K/CRI 80 - 220 \pm 240V / 34W - 4152 lm \neq OUTPUT 2712 lm - 4000K/CRI 80 - 220 \pm 240V

- | | | |
|--|--|--|
| <p>2700K
Non Dimmable</p> <ul style="list-style-type: none"> ● FA533421 <p>1-10V</p> <ul style="list-style-type: none"> ● FA533421-310 <p>Dali</p> <ul style="list-style-type: none"> ● FA533421-300 | <p>3000K
Non Dimmable</p> <ul style="list-style-type: none"> ● FA533431 <p>1-10V</p> <ul style="list-style-type: none"> ● FA533431-310 <p>Dali</p> <ul style="list-style-type: none"> ● FA533431-300 | <p>4000K
Non Dimmable</p> <ul style="list-style-type: none"> ● FA533441 <p>1-10V</p> <ul style="list-style-type: none"> ● FA533441-310 <p>Dali</p> <ul style="list-style-type: none"> ● FA533441-300 |
|--|--|--|

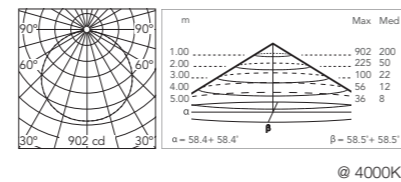

Platter 410 Anthracite / Pale Blue

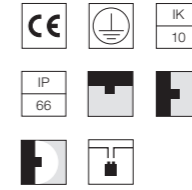
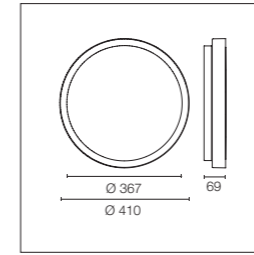

Sorgente a LED inclusa. Alimentazione elettrica 220-240V ON/ OFF e dimmerabile 1-10V o DALI integrata. Dotata di passacavo IP65, per cavi in gomma 5mm< ϕ <10mm e una morsettiere a 2 poli a connessione rapida. Per garantire la tenuta del passacavo è consigliabile utilizzare cavi elettrici flessibili idonei all'impiego in ambienti esterni.

LED source included. Integrated power supply 220-240V ON/OFF and dimmable 1-10V or DALI. With IP65 cable guide for rubber cables 5mm< ϕ <10mm and a 2-pole connection box for a fast connection. To ensure the tightness of the cable guide it's recommended to use flexible electric cables suitable for exterior use.

Mid-Power Led: 34W - 3590 lm \neq OUTPUT 2345 lm - 2700K/CRI 80 - 220 \pm 240V / 34W - 3860 lm \neq OUTPUT 2521 lm - 3000K/CRI 80 - 220 \pm 240V / 34W - 4152 lm \neq OUTPUT 2712 lm - 4000K/CRI 80 - 220 \pm 240V

- | | | |
|--|--|--|
| <p>2700K
Non Dimmable</p> <ul style="list-style-type: none"> ● FA533422 <p>1-10V</p> <ul style="list-style-type: none"> ● FA533422-310 <p>Dali</p> <ul style="list-style-type: none"> ● FA533422-300 | <p>3000K
Non Dimmable</p> <ul style="list-style-type: none"> ● FA533432 <p>1-10V</p> <ul style="list-style-type: none"> ● FA533432-310 <p>Dali</p> <ul style="list-style-type: none"> ● FA533432-300 | <p>4000K
Non Dimmable</p> <ul style="list-style-type: none"> ● FA533442 <p>1-10V</p> <ul style="list-style-type: none"> ● FA533442-310 <p>Dali</p> <ul style="list-style-type: none"> ● FA533442-300 |
|--|--|--|

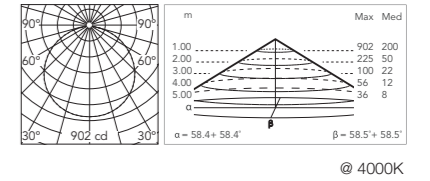

Platter 410 Deep Brown / Pale Brown

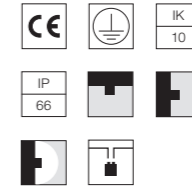
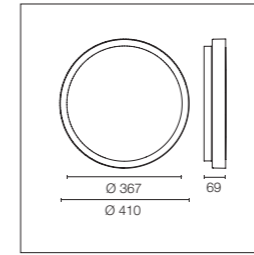

Sorgente a LED inclusa. Alimentazione elettrica 220-240V ON/ OFF e dimmerabile 1-10V o DALI integrata. Dotata di passacavo IP65, per cavi in gomma 5mm< ϕ <10mm e una morsettiere a 2 poli a connessione rapida. Per garantire la tenuta del passacavo è consigliabile utilizzare cavi elettrici flessibili idonei all'impiego in ambienti esterni.

LED source included. Integrated power supply 220-240V ON/OFF and dimmable 1-10V or DALI. With IP65 cable guide for rubber cables 5mm< ϕ <10mm and a 2-pole connection box for a fast connection. To ensure the tightness of the cable guide it's recommended to use flexible electric cables suitable for exterior use.

Mid-Power Led: 34W - 3590 lm \neq OUTPUT 2345 lm - 2700K/CRI 80 - 220 \pm 240V / 34W - 3860 lm \neq OUTPUT 2521 lm - 3000K/CRI 80 - 220 \pm 240V / 34W - 4152 lm \neq OUTPUT 2712 lm - 4000K/CRI 80 - 220 \pm 240V

- | | | |
|--|--|--|
| <p>2700K
Non Dimmable</p> <ul style="list-style-type: none"> ● FA533423 <p>1-10V</p> <ul style="list-style-type: none"> ● FA533423-310 <p>Dali</p> <ul style="list-style-type: none"> ● FA533423-300 | <p>3000K
Non Dimmable</p> <ul style="list-style-type: none"> ● FA533433 <p>1-10V</p> <ul style="list-style-type: none"> ● FA533433-310 <p>Dali</p> <ul style="list-style-type: none"> ● FA533433-300 | <p>4000K
Non Dimmable</p> <ul style="list-style-type: none"> ● FA533443 <p>1-10V</p> <ul style="list-style-type: none"> ● FA533443-310 <p>Dali</p> <ul style="list-style-type: none"> ● FA533443-300 |
|--|--|--|

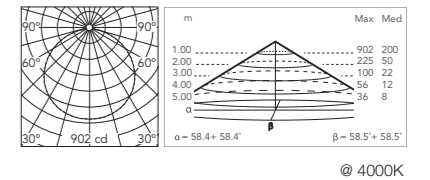

Platter 410 Forest Green / Olive Green

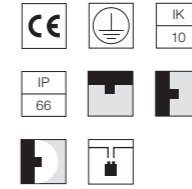
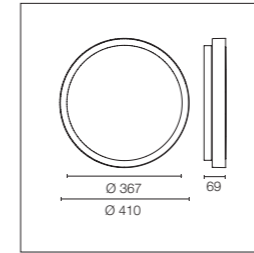

Sorgente a LED inclusa. Alimentazione elettrica 220-240V ON/ OFF e dimmerabile 1-10V o DALI integrata. Dotata di passacavo IP65, per cavi in gomma 5mm< ϕ <10mm e una morsettiere a 2 poli a connessione rapida. Per garantire la tenuta del passacavo è consigliabile utilizzare cavi elettrici flessibili idonei all'impiego in ambienti esterni.

LED source included. Integrated power supply 220-240V ON/OFF and dimmable 1-10V or DALI. With IP65 cable guide for rubber cables 5mm< ϕ <10mm and a 2-pole connection box for a fast connection. To ensure the tightness of the cable guide it's recommended to use flexible electric cables suitable for exterior use.

Mid-Power Led: 34W - 3590 lm \neq OUTPUT 2345 lm - 2700K/CRI 80 - 220 \pm 240V / 34W - 3860 lm \neq OUTPUT 2521 lm - 3000K/CRI 80 - 220 \pm 240V / 34W - 4152 lm \neq OUTPUT 2712 lm - 4000K/CRI 80 - 220 \pm 240V

- | | | |
|--|--|--|
| <p>2700K
Non Dimmable</p> <ul style="list-style-type: none"> ● FA533424 <p>1-10V</p> <ul style="list-style-type: none"> ● FA533424-310 <p>Dali</p> <ul style="list-style-type: none"> ● FA533424-300 | <p>3000K
Non Dimmable</p> <ul style="list-style-type: none"> ● FA533434 <p>1-10V</p> <ul style="list-style-type: none"> ● FA533434-310 <p>Dali</p> <ul style="list-style-type: none"> ● FA533434-300 | <p>4000K
Non Dimmable</p> <ul style="list-style-type: none"> ● FA533444 <p>1-10V</p> <ul style="list-style-type: none"> ● FA533444-310 <p>Dali</p> <ul style="list-style-type: none"> ● FA533444-300 |
|--|--|--|

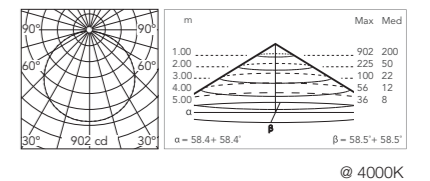

Platter 310

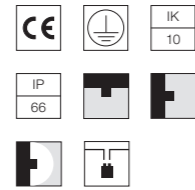
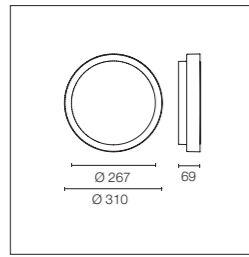

Sorgente a LED inclusa. Alimentazione elettrica 220-240V ON/ OFF e dimmerabile 1-10V o DALI integrata. Dotata di passacavo IP65, per cavi in gomma 5mmϕ<math><10\text{mm}</math> e una morsettiere a 2 poli a connessione rapida. Per garantire la tenuta del passacavo è consigliabile utilizzare cavi elettrici flessibili idonei all'impiego in ambienti esterni.

LED source included. Integrated power supply 220-240V ON/OFF and dimmable 1-10V or DALI. With IP65 cable guide for rubber cables 5mmϕ<math><10\text{mm}</math> and a 2-pole connection box for a fast connection. To ensure the tightness of the cable guide it's recommended to use flexible electric cables suitable for exterior use.

Mid-Power Led: 18W - 1874 lm \neq OUTPUT 1150 lm - 2700K/CRI 80 - 220 \pm 240V / 18W - 2015 lm \neq OUTPUT 1237 lm - 3000K/CRI 80 - 220 \pm 240V / 18W - 2168 lm \neq OUTPUT 1330 lm - 4000K/CRI 80 - 220 \pm 240V

2700K	3000K	4000K
Non Dimmable	Non Dimmable	Non Dimmable
○ FA53305101	○ FA53301201	○ FA53301101
● FA53305106	● FA53301206	● FA53301106
● FA53305112	● FA53301212	● FA53301112
● FA53305118	● FA53301218	● FA53301118
● FA53305130	● FA53301230	● FA53301130
● FA53305133	● FA53301233	● FA53301133
1-10V	1-10V	1-10V
○ FA53305101-310	○ FA53301201-310	○ FA53301101-310
● FA53305106-310	● FA53301206-310	● FA53301106-310
● FA53305112-310	● FA53301212-310	● FA53301112-310
● FA53305118-310	● FA53301218-310	● FA53301118-310
● FA53305130-310	● FA53301230-310	● FA53301130-310
● FA53305133-310	● FA53301233-310	● FA53301133-310
Dali	Dali	Dali
○ FA53305101-300	○ FA53301201-300	○ FA53301101-300
● FA53305106-300	● FA53301206-300	● FA53301106-300
● FA53305112-300	● FA53301212-300	● FA53301112-300
● FA53305118-300	● FA53301218-300	● FA53301118-300
● FA53305130-300	● FA53301230-300	● FA53301130-300
● FA53305133-300	● FA53301233-300	● FA53301133-300

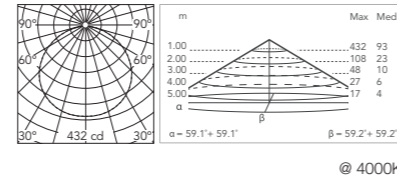

Platter 310 Grey / Brown Brick

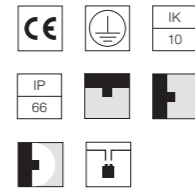
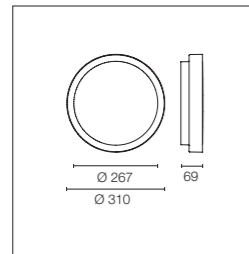

Sorgente a LED inclusa. Alimentazione elettrica 220-240V ON/ OFF e dimmerabile 1-10V o DALI integrata. Dotata di passacavo IP65, per cavi in gomma 5mmϕ<math><10\text{mm}</math> e una morsettiere a 2 poli a connessione rapida. Per garantire la tenuta del passacavo è consigliabile utilizzare cavi elettrici flessibili idonei all'impiego in ambienti esterni.

LED source included. Integrated power supply 220-240V ON/OFF and dimmable 1-10V or DALI. With IP65 cable guide for rubber cables 5mmϕ<math><10\text{mm}</math> and a 2-pole connection box for a fast connection. To ensure the tightness of the cable guide it's recommended to use flexible electric cables suitable for exterior use.

Mid-Power Led: 18W - 1874 lm \neq OUTPUT 1150 lm - 2700K/CRI 80 - 220 \pm 240V / 18W - 2015 lm \neq OUTPUT 1237 lm - 3000K/CRI 80 - 220 \pm 240V / 18W - 2168 lm \neq OUTPUT 1330 lm - 4000K/CRI 80 - 220 \pm 240V

2700K	3000K	4000K
Non Dimmable	Non Dimmable	Non Dimmable
● FA533321	● FA533331	● FA533341
1-10V	1-10V	1-10V
● FA533321-310	● FA533331-310	● FA533341-310
Dali	Dali	Dali
● FA533321-300	● FA533331-300	● FA533341-300

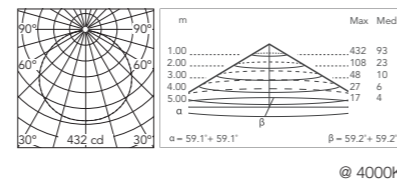

Platter 310 Anthracite / Pale Blue

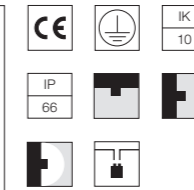
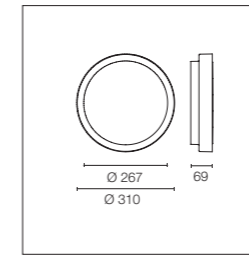

Sorgente a LED inclusa. Alimentazione elettrica 220-240V ON/ OFF e dimmerabile 1-10V o DALI integrata. Dotata di passacavo IP65, per cavi in gomma 5mmϕ<math><10\text{mm}</math> e una morsettiere a 2 poli a connessione rapida. Per garantire la tenuta del passacavo è consigliabile utilizzare cavi elettrici flessibili idonei all'impiego in ambienti esterni.

LED source included. Integrated power supply 220-240V ON/OFF and dimmable 1-10V or DALI. With IP65 cable guide for rubber cables 5mmϕ<math><10\text{mm}</math> and a 2-pole connection box for a fast connection. To ensure the tightness of the cable guide it's recommended to use flexible electric cables suitable for exterior use.

Mid-Power Led: 34W - 3590 lm \neq OUTPUT 2345 lm - 2700K/CRI 80 - 220 \pm 240V / 34W - 3860 lm \neq OUTPUT 2521 lm - 3000K/CRI 80 - 220 \pm 240V / 34W - 4152 lm \neq OUTPUT 2712 lm - 4000K/CRI 80 - 220 \pm 240V

2700K	3000K	4000K
Non Dimmable	Non Dimmable	Non Dimmable
● FA533322	● FA533332	● FA533342
1-10V	1-10V	1-10V
● FA533322-310	● FA533332-310	● FA533342-310
Dali	Dali	Dali
● FA533322-300	● FA533332-300	● FA533342-300

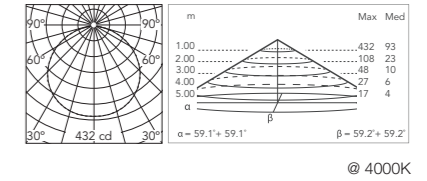

Platter 310 Deep Brown / Pale Brown

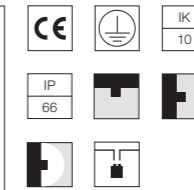
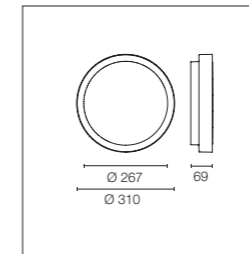

Sorgente a LED inclusa. Alimentazione elettrica 220-240V ON/ OFF e dimmerabile 1-10V o DALI integrata. Dotata di passacavo IP65, per cavi in gomma 5mmϕ<math><10\text{mm}</math> e una morsettiere a 2 poli a connessione rapida. Per garantire la tenuta del passacavo è consigliabile utilizzare cavi elettrici flessibili idonei all'impiego in ambienti esterni.

LED source included. Integrated power supply 220-240V ON/OFF and dimmable 1-10V or DALI. With IP65 cable guide for rubber cables 5mmϕ<math><10\text{mm}</math> and a 2-pole connection box for a fast connection. To ensure the tightness of the cable guide it's recommended to use flexible electric cables suitable for exterior use.

Mid-Power Led: 34W - 3590 lm \neq OUTPUT 2345 lm - 2700K/CRI 80 - 220 \pm 240V / 34W - 3860 lm \neq OUTPUT 2521 lm - 3000K/CRI 80 - 220 \pm 240V / 34W - 4152 lm \neq OUTPUT 2712 lm - 4000K/CRI 80 - 220 \pm 240V

2700K	3000K	4000K
Non Dimmable	Non Dimmable	Non Dimmable
● FA533323	● FA533333	● FA533343
1-10V	1-10V	1-10V
● FA533323-310	● FA533333-310	● FA533343-310
Dali	Dali	Dali
● FA533323-300	● FA533333-300	● FA533343-300

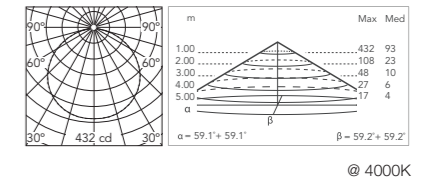

Platter 310 Forest Green / Olive Green

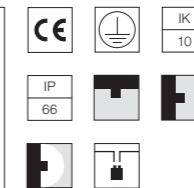
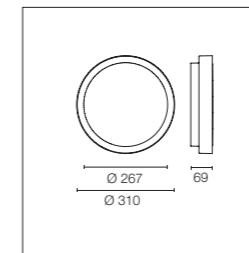

Sorgente a LED inclusa. Alimentazione elettrica 220-240V ON/ OFF e dimmerabile 1-10V o DALI integrata. Dotata di passacavo IP65, per cavi in gomma 5mmϕ<math><10\text{mm}</math> e una morsettiere a 2 poli a connessione rapida. Per garantire la tenuta del passacavo è consigliabile utilizzare cavi elettrici flessibili idonei all'impiego in ambienti esterni.

LED source included. Integrated power supply 220-240V ON/OFF and dimmable 1-10V or DALI. With IP65 cable guide for rubber cables 5mmϕ<math><10\text{mm}</math> and a 2-pole connection box for a fast connection. To ensure the tightness of the cable guide it's recommended to use flexible electric cables suitable for exterior use.

Mid-Power Led: 34W - 3590 lm \neq OUTPUT 2345 lm - 2700K/CRI 80 - 220 \pm 240V / 34W - 3860 lm \neq OUTPUT 2521 lm - 3000K/CRI 80 - 220 \pm 240V / 34W - 4152 lm \neq OUTPUT 2712 lm - 4000K/CRI 80 - 220 \pm 240V

2700K	3000K	4000K
Non Dimmable	Non Dimmable	Non Dimmable
● FA533324	● FA533334	● FA533344
1-10V	1-10V	1-10V
● FA533324-310	● FA533334-310	● FA533344-310
Dali	Dali	Dali
● FA533324-300	● FA533334-300	● FA533344-300

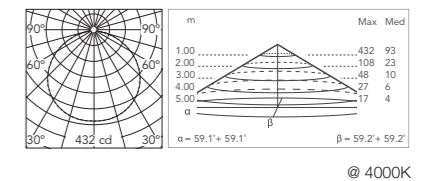

Platter 210

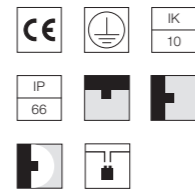
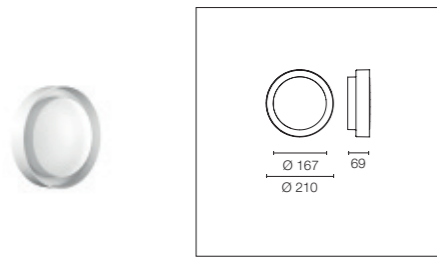

Sorgente a LED inclusa. Alimentazione elettrica 220-240V ON/ OFF integrata. Dotata di passacavo IP65, per cavi in gomma 5mm< ϕ <10mm e una morsetteria a 2 poli a connessione rapida. Per garantire la tenuta del passacavo è consigliabile utilizzare cavi elettrici flessibili idonei all'impiego in ambienti esterni.

LED source included. Integrated electrical power supply 220-240V ON/OFF. With IP65 cable guide for rubber cables 5mm< ϕ <10mm and a 2-pole connection box for a fast connection. To ensure the tightness of the cable guide it's recommended to use flexible electric cables suitable for exterior use.

Mid-Power Led: 11W - 1202 lm \neq OUTPUT 732 lm - 2700K/CRI 80 - 220 \pm 240V / 11W - 1292 lm \neq OUTPUT 787 lm - 3000K/CRI 80 - 220 \pm 240V / 11W - 1334 lm \neq OUTPUT 812 lm - 4000K/CRI 80 - 220 \pm 240V

- | | | |
|--------------|--------------|--------------|
| 2700K | 3000K | 4000K |
| ○ FA53305001 | ○ FA53300201 | ○ FA53300101 |
| ● FA53305006 | ● FA53300206 | ● FA53300106 |
| ● FA53305012 | ● FA53300212 | ● FA53300112 |
| ● FA53305018 | ● FA53300218 | ● FA53300118 |
| ● FA53305030 | ● FA53300230 | ● FA53300130 |
| ● FA53305033 | ● FA53300233 | ● FA53300133 |

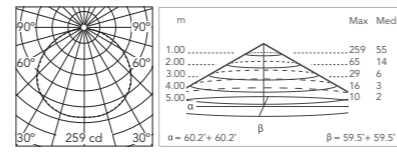

@ 4000K

Platter 210 Grey / Brown Brick

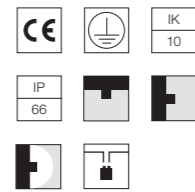
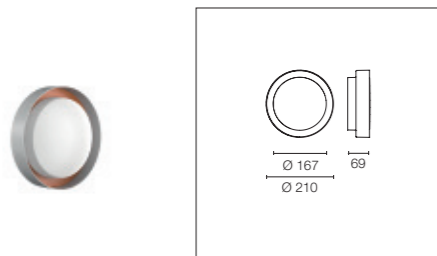

Sorgente a LED inclusa. Alimentazione elettrica 220-240V ON/ OFF integrata. Dotata di passacavo IP65, per cavi in gomma 5mm< ϕ <10mm e una morsetteria a 2 poli a connessione rapida. Per garantire la tenuta del passacavo è consigliabile utilizzare cavi elettrici flessibili idonei all'impiego in ambienti esterni.

LED source included. Integrated electrical power supply 220-240V ON/OFF. With IP65 cable guide for rubber cables 5mm< ϕ <10mm and a 2-pole connection box for a fast connection. To ensure the tightness of the cable guide it's recommended to use flexible electric cables suitable for exterior use.

Mid-Power Led: 11W - 1261 lm \neq OUTPUT 765 lm - 2700K/CRI 80 - 220 \pm 240V / 11W - 1292 lm \neq OUTPUT 787 lm - 3000K/CRI 80 - 220 \pm 240V / 11W - 1334 lm \neq OUTPUT 812 lm - 4000K/CRI 80 - 220 \pm 240V

- | | | |
|--------------|--------------|--------------|
| 2700K | 3000K | 4000K |
| ● FA533221 | ● FA533231 | ● FA533241 |

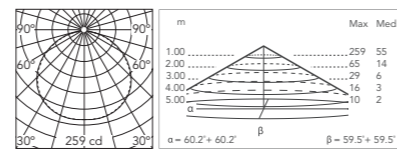

@ 4000K

Platter 210 Anthracite / Pale Blue

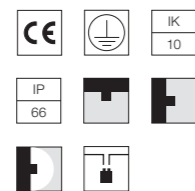
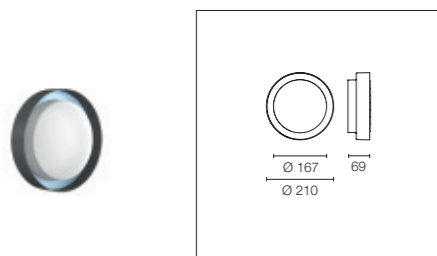

Sorgente a LED inclusa. Alimentazione elettrica 220-240V ON/ OFF integrata. Dotata di passacavo IP65, per cavi in gomma 5mm< ϕ <10mm e una morsetteria a 2 poli a connessione rapida. Per garantire la tenuta del passacavo è consigliabile utilizzare cavi elettrici flessibili idonei all'impiego in ambienti esterni.

LED source included. Integrated electrical power supply 220-240V ON/OFF. With IP65 cable guide for rubber cables 5mm< ϕ <10mm and a 2-pole connection box for a fast connection. To ensure the tightness of the cable guide it's recommended to use flexible electric cables suitable for exterior use.

Mid-Power Led: 11W - 1202 lm \neq OUTPUT 732 lm - 2700K/CRI 80 - 220 \pm 240V / 11W - 1292 lm \neq OUTPUT 787 lm - 3000K/CRI 80 - 220 \pm 240V / 11W - 1334 lm \neq OUTPUT 812 lm - 4000K/CRI 80 - 220 \pm 240V

- | | | |
|--------------|--------------|--------------|
| 2700K | 3000K | 4000K |
| ● FA533222 | ● FA533232 | ● FA533242 |

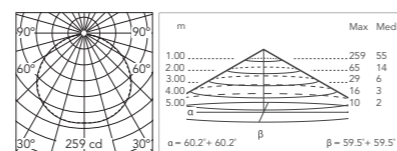

@ 4000K

Platter 210 Deep Brown / Pale Brown

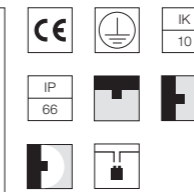
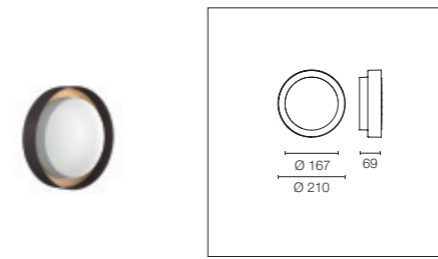

Sorgente a LED inclusa. Alimentazione elettrica 220-240V ON/ OFF integrata. Dotata di passacavo IP65, per cavi in gomma 5mm< ϕ <10mm e una morsetteria a 2 poli a connessione rapida. Per garantire la tenuta del passacavo è consigliabile utilizzare cavi elettrici flessibili idonei all'impiego in ambienti esterni.

LED source included. Integrated electrical power supply 220-240V ON/OFF. With IP65 cable guide for rubber cables 5mm< ϕ <10mm and a 2-pole connection box for a fast connection. To ensure the tightness of the cable guide it's recommended to use flexible electric cables suitable for exterior use.

Mid-Power Led: 11W - 1202 lm \neq OUTPUT 732 lm - 2700K/CRI 80 - 220 \pm 240V / 11W - 1292 lm \neq OUTPUT 787 lm - 3000K/CRI 80 - 220 \pm 240V / 11W - 1334 lm \neq OUTPUT 812 lm - 4000K/CRI 80 - 220 \pm 240V

- | | | |
|--------------|--------------|--------------|
| 2700K | 3000K | 4000K |
| ● FA533223 | ● FA533233 | ● FA533243 |

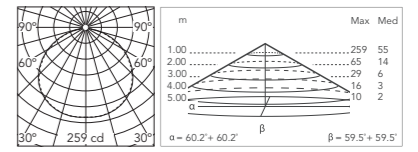

@ 4000K

Platter 210 Forest Green / Olive Green

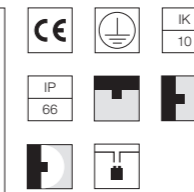
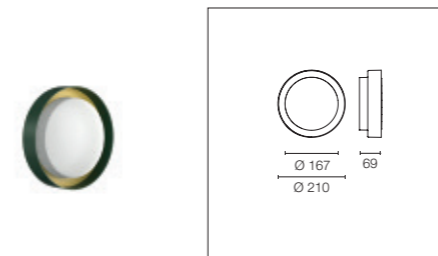

Sorgente a LED inclusa. Alimentazione elettrica 220-240V ON/ OFF integrata. Dotata di passacavo IP65, per cavi in gomma 5mm< ϕ <10mm e una morsetteria a 2 poli a connessione rapida. Per garantire la tenuta del passacavo è consigliabile utilizzare cavi elettrici flessibili idonei all'impiego in ambienti esterni.

LED source included. Integrated electrical power supply 220-240V ON/OFF. With IP65 cable guide for rubber cables 5mm< ϕ <10mm and a 2-pole connection box for a fast connection. To ensure the tightness of the cable guide it's recommended to use flexible electric cables suitable for exterior use.

Mid-Power Led: 11W - 1202 lm \neq OUTPUT 732 lm - 2700K/CRI 80 - 220 \pm 240V / 11W - 1292 lm \neq OUTPUT 787 lm - 3000K/CRI 80 - 220 \pm 240V / 11W - 1334 lm \neq OUTPUT 812 lm - 4000K/CRI 80 - 220 \pm 240V

- | | | |
|--------------|--------------|--------------|
| 2700K | 3000K | 4000K |
| ● FA533224 | ● FA533234 | ● FA533244 |

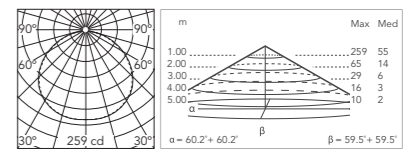

@ 4000K

Platter: Accessori / Accessories

Dispositivo di protezione per il sovraccarico. 275Vac. Corrente massima di scarica 10KA (8/29 μ s). Massima corrente operativa 5A. Adatto per la connessione in serie. IP66.

Surge protection device. 275Vac. Maximum discharge current 10KA (8/29 μ s). Maximum operating current 5A. Suitable for series connection. IP66.

F990E00A000

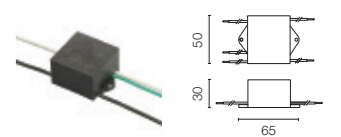

Emma





Emma Ceiling 2

Emma Wall 1



Emma Wall 3

Famiglia / Family

Emma Wall 1



Par 16
up to 35W
230V - GZ10

Power Led
up to 6W
up to 303 lm - 2700K/CRI 80
up to 328 lm - 3000K/CRI 80
up to 340 lm - 4000K/CRI 80
* Net lumen output

Emma Wall 2 Mono / Double



Power Led
up to 6,5W
up to 439 lm - 2700K/CRI 80
up to 472 lm - 3000K/CRI 80
up to 488 lm - 4000K/CRI 80
* Net lumen output

Power Led
up to 12W
up to 2x439 lm - 2700K/CRI 80
up to 2x472 lm - 3000K/CRI 80
up to 2x488 lm - 4000K/CRI 80
* Net lumen output

Emma Wall 3 Mono / Double



CoB Led
up to 14,5W
up to 1569 lm - 2700K/CRI 80
up to 1687 lm - 3000K/CRI 80
up to 1757 lm - 4000K/CRI 80
* Net lumen output

CoB Led
up to 27W
up to 2x1569 lm - 2700K/CRI 80
up to 2x1687 lm - 3000K/CRI 80
up to 2x1757 lm - 4000K/CRI 80
* Net lumen output

Emma Wall 4 Mono / Double



CoB Led
up to 20W
up to 2121 lm - 2700K/CRI 80
up to 2281 lm - 3000K/CRI 80
up to 2382 lm - 4000K/CRI 80
* Net lumen output

CoB Led
up to 39W
up to 2x2121 lm - 2700K/CRI 80
up to 2x2281 lm - 3000K/CRI 80
up to 2x2382 lm - 4000K/CRI 80
* Net lumen output

Emma Ceiling 2



Power Led
up to 6W
up to 314 lm - 2700K/CRI 80
up to 338 lm - 3000K/CRI 80
up to 363 lm - 4000K/CRI 80
* Net lumen output

Emma Ceiling 3



CoB Led
up to 12W
up to 752 lm - 3000K/CRI 80

CoB Led
up to 15W
up to 1455 lm - 2700K/CRI 80
up to 1564 lm - 3000K/CRI 80
up to 1641 lm - 4000K/CRI 80
* Net lumen output

Emma Ceiling 4



CoB Led
up to 24W
up to 1659 lm - 3000K/CRI 80

CoB Led
up to 20W
up to 1907 lm - 2700K/CRI 80
up to 2050 lm - 3000K/CRI 80
up to 2102 lm - 4000K/CRI 80
* Net lumen output

Descrizione / Description

Famiglia completa di apparecchi di illuminazione con sorgente luminosa a LED per installazione a parete e a soffitto, caratterizzati dalla forma cilindrica declinata in diversi diametri. Disponibili in differenti finiture con rivestimento a doppio strato di polveri e sottoposte a trattamento di conversione chimica superficiale per una elevata resistenza alla corrosione. Le viterie di fissaggio sono in acciaio inox AISI 316L.

Emma Wall

Apparecchio per installazione a parete disponibile in tre dimensioni di diametro. Disponibile in versione monoemissione e biemissione con differenti fasci di apertura. Corpo dell'apparecchio in alluminio estruso; basetta di fissaggio e ghiera di chiusura superiore e inferiore in alluminio pressofuso EN AB-47100 (a basso contenuto di rame). Diffusore in vetro extrachiaro con bordo serigrafato, fissato attraverso un sistema di incollaggio robotizzato a filo con il bordo lampada per evitare depositi d'acqua. Staffa di fissaggio in acciaio inox inclusa.

Emma Ceiling

Apparecchio per installazione a soffitto disponibile in tre dimensioni di diametro. Disponibile in differenti fasci di apertura. Corpo dell'apparecchio in alluminio estruso; basetta di fissaggio e ghiera di chiusura in alluminio pressofuso EN AB-47100 (a basso contenuto di rame). Diffusore in vetro extrachiaro o texturizzato con bordo serigrafato, fissato attraverso un sistema di incollaggio robotizzato a filo con il bordo lampada per evitare depositi d'acqua.

Complete luminaire family with LED source for wall and ceiling mounting. Defined by their cylinder shape. Available in different diameters and different finishes, with double-layered powder coating and chemical conversion surface treatment to ensure high corrosion resistance. The fixing screws are made of stainless steel AISI 316L.

Emma Wall

Wall luminaire, available in three different diameters. Available in mono-emission and bi-emission versions with different beam angles. Extruded aluminum body, EN AB-47100 die cast aluminum mounting plate and top and bottom lid (with low copper content). Extraclear glass diffuser with silkscreen edge, attached flush to the edge of the lamp with a robotic gluing system to avoid water deposits. Stainless steel bracket included.

Emma Ceiling

Ceiling luminaire, available in three different diameters and different beam angles. Extruded aluminum body, EN AB-47100 die cast aluminum mounting plate and top and bottom lid (with low copper content). Extraclear glass diffuser with silkscreen and textured edge, attached flush to the edge of the lamp with a robotic gluing system to avoid water deposits.

Colori / Colours



01 White



06 Grey



12 Forest Green



18 Deep Brown



30 Black



33 Anthracite

Emma Wall 1 Retrofit

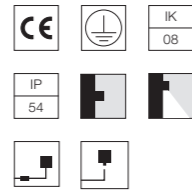
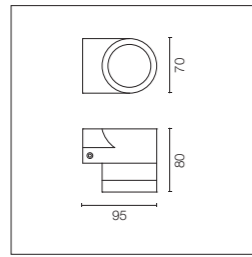

Sorgente attacco GZ10 esclusa; compatibile con lampadine LED retrofit. Alimentazione elettrica 220-230V ON/ OFF. Dotata di passacavo IP65, per cavi in gomma 5mm< ϕ <10mm e una morsettiere a 2 poli a connessione rapida. Per garantire la tenuta del passacavo è consigliabile utilizzare cavi elettrici flessibili idonei all'impiego in ambienti esterni.

GZ10 bulb holder not included, compatible with retrofit LED bulbs. Electrical power supply 220-230V ON/OFF. With IP65 cable guide for rubber cables 5mm< ϕ <10mm and a 2-pole connection box for fast connections. To ensure the tightness of the cable guide it's recommended to use flexible electric cables suitable for exterior use.

PAR 16: 35W - 230V - GZ 10 - Optional LED bulb: DR PAR 7,5W - 230V - GZ 10 - Lamp max size ϕ 50mm H. 55mm

- FA84280001
- FA84280006
- FA84280012
- FA84280018
- FA84280030
- FA84280033

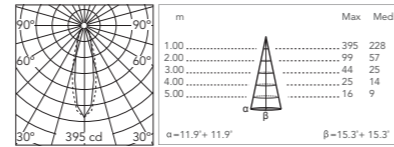

Emma Wall 2 Mono Retrofit

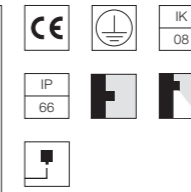
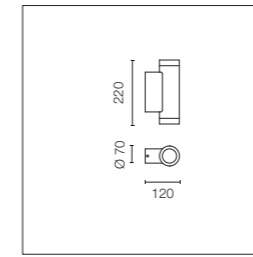

Sorgente attacco GZ10 esclusa; compatibile con lampadine LED retrofit. Alimentazione elettrica 220-230V ON/ OFF. Dotata di passacavo IP65, per cavi in gomma 5mm< ϕ <10mm e una morsettiere a connessione rapida. Per garantire la tenuta del passacavo è consigliabile utilizzare cavi elettrici flessibili idonei all'impiego in ambienti esterni.

GZ10 bulb holder not included, compatible with retrofit LED bulbs. Electrical power supply 220-230V ON/OFF. With IP65 cable guide for rubber cables 5mm< ϕ <10mm and a connection box for fast connections. To ensure the tightness of the cable guide it's recommended to use flexible electric cables suitable for exterior use.

PAR 16: 50W - 230V - GZ 10 - Lamp max size ϕ 50mm H. 55mm - Optional LED bulb: DR PAR 7,5W - 230V - GZ 10

- FA116282101
- FA116282106
- FA116282112
- FA116282118
- FA116282130
- FA116282133

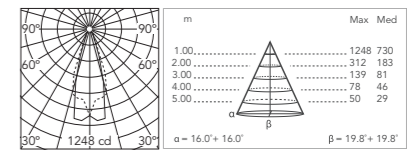

@ 4000K

Emma Wall 1

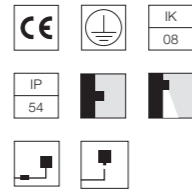
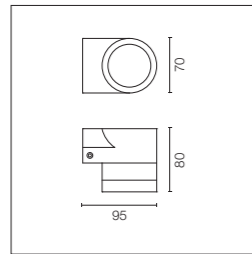

Sorgente a LED inclusa. Alimentazione 220-240 ON/ OFF integrata. Dotata di passacavo IP65, per cavi in gomma 5mm< ϕ <10mm e una morsettiere a connessione rapida. Per garantire la tenuta del passacavo è consigliabile utilizzare cavi elettrici flessibili idonei all'impiego in ambienti esterni.

LED source included. Integrated electrical power supply 220-240V ON/OFF. With IP65 cable guide for rubber cables 5mm< ϕ <10mm and a connection box for fast connections. To ensure the tightness of the cable guide it's recommended to use flexible electric cables suitable for exterior use.

Optic Spot 14°

Power Led: 6W - 417 lm \neq OUTPUT 303 lm - 2700K/CRI 80 - 220÷230V / 6W - 447 lm \neq OUTPUT 328 lm - 3000K/CRI 80 - 220÷230V / 6W - 462 lm \neq OUTPUT 340 lm - 4000K/CRI 80 - 220÷230V

- | | | |
|---------------|---------------|---------------|
| 2700K | 3000K | 4000K |
| ○ FA844281101 | ○ FA844281201 | ○ FA844281301 |
| ● FA844281106 | ● FA844281206 | ● FA844281306 |
| ● FA844281112 | ● FA844281212 | ● FA844281312 |
| ● FA844281118 | ● FA844281218 | ● FA844281318 |
| ● FA844281130 | ● FA844281230 | ● FA844281330 |
| ● FA844281133 | ● FA844281233 | ● FA844281333 |

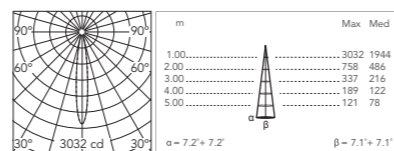

@ 3000K

Optic Medium 54°

Power Led: 6W - 417 lm \neq OUTPUT 270 lm - 2700K/CRI 80 - 220÷230V / 6W - 447 lm \neq OUTPUT 293 lm - 3000K/CRI 80 - 220÷230V / 6W - 462 lm \neq OUTPUT 304 lm - 4000K/CRI 80 - 220÷230V

- | | | |
|---------------|---------------|---------------|
| 2700K | 3000K | 4000K |
| ○ FA844282101 | ○ FA844282201 | ○ FA844282301 |
| ● FA844282106 | ● FA844282206 | ● FA844282306 |
| ● FA844282112 | ● FA844282212 | ● FA844282312 |
| ● FA844282118 | ● FA844282218 | ● FA844282318 |
| ● FA844282130 | ● FA844282230 | ● FA844282330 |
| ● FA844282133 | ● FA844282233 | ● FA844282333 |

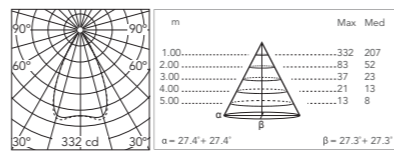

@ 3000K

Emma Wall 2 Mono Led

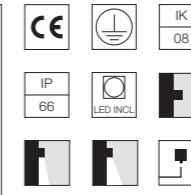
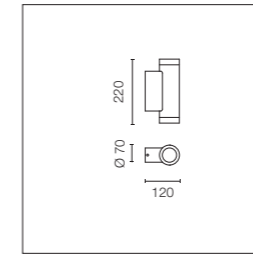

Sorgente a LED inclusa. Alimentazione elettrica 220-240V ON/ OFF integrata. Dotata di passacavo IP65, per cavi in gomma 5mm< ϕ <10mm e una morsettiere a connessione rapida. Per garantire la tenuta del passacavo è consigliabile utilizzare cavi elettrici flessibili idonei all'impiego in ambienti esterni.

LED source included. Integrated electrical power supply 220-240V ON/OFF. With IP65 cable guide for rubber cables 5mm< ϕ <10mm and a connection box for fast connections. To ensure the tightness of the cable guide it's recommended to use flexible electric cables suitable for exterior use.

Optic Spot 14°

Power Led: 6,5W - 574 lm \neq OUTPUT 439 lm - 2700K/CRI 80 - 110÷240V / 6,5W - 617 lm \neq OUTPUT 472 lm - 3000K/CRI 80 - 110÷240V / 6,5W - 649 lm \neq OUTPUT 488 lm - 4000K/CRI 80 - 110÷240V

- | | | |
|---------------|---------------|----------------|
| 2700K | 3000K | 4000K |
| ○ FA116271201 | ○ FA116561201 | ○ FA1161721201 |
| ● FA116271206 | ● FA116561206 | ● FA1161721206 |
| ● FA116271212 | ● FA116561212 | ● FA1161721212 |
| ● FA116271218 | ● FA116561218 | ● FA1161721218 |
| ● FA116271230 | ● FA116561230 | ● FA1161721230 |
| ● FA116271233 | ● FA116561233 | ● FA1161721233 |

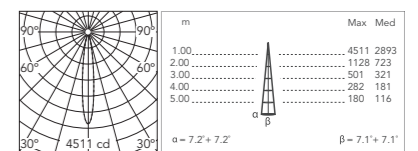

@ 4000K

Optic Medium 54°

Power Led: 6,5W - 574 lm \neq OUTPUT 392 lm - 2700K/CRI 80 - 110÷240V / 6,5W - 617 lm \neq OUTPUT 422 lm - 3000K/CRI 80 - 110÷240V / 6,5W - 649 lm \neq OUTPUT 436 lm - 4000K/CRI 80 - 110÷240V

- | | | |
|---------------|---------------|----------------|
| 2700K | 3000K | 4000K |
| ○ FA116272101 | ○ FA116562101 | ○ FA1161722101 |
| ● FA116272106 | ● FA116562106 | ● FA1161722106 |
| ● FA116272112 | ● FA116562112 | ● FA1161722112 |
| ● FA116272118 | ● FA116562118 | ● FA1161722118 |
| ● FA116272130 | ● FA116562130 | ● FA1161722130 |
| ● FA116272133 | ● FA116562133 | ● FA1161722133 |

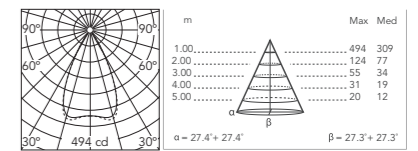

@ 4000K

Emma Wall 2 Double Retrofit

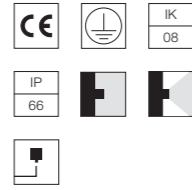
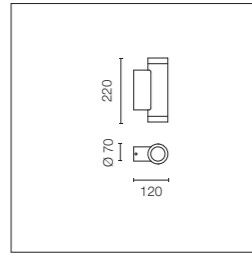

Sorgente attacco GZ10 esclusa; compatibile con lampadine LED retrofit. Alimentazione elettrica 220-230V ON/ OFF. Dotata di passacavo IP65, per cavi in gomma 5mm< ϕ <10mm e una morsettiere a 2 poli a connessione rapida. Per garantire la tenuta del passacavo è consigliabile utilizzare cavi elettrici flessibili idonei all'impiego in ambienti esterni.

GZ10 bulb holder not included, compatible with retrofit LED bulbs. Electrical power supply 220-230V ON/OFF. With IP65 cable guide for rubber cables 5mm< ϕ <10mm and a 2-pole connection box for fast connections. To ensure the tightness of the cable guide it's recommended to use flexible electric cables suitable for exterior use.

PAR 16: 2x50W - 230V - GZ 10 - Lamp max size ϕ 50mm H. 55mm - Optional LED bulb: DR PAR 7,5W - 230V - GZ 10

- FA116284201
- FA116284206
- FA116284212
- FA116284218
- FA116284230
- FA116284233

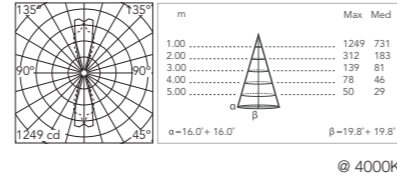

Emma Wall 2 Double Led

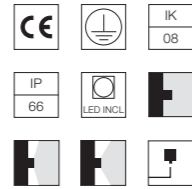
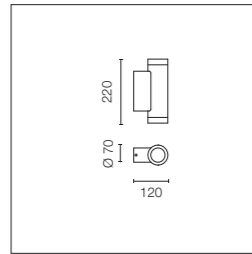

Sorgente a LED inclusa. Alimentazione elettrica 220-240V ON/ OFF integrata. Dotata di passacavo IP65, per cavi in gomma 5mm< ϕ <10mm e una morsettiere a connessione rapida. Per garantire la tenuta del passacavo è consigliabile utilizzare cavi elettrici flessibili idonei all'impiego in ambienti esterni.

LED source included. Electrical power supply 220-240V ON/ OFF. With IP65 cable guide for rubber cables 5mm< ϕ <10mm and a connection box for fast connections. To ensure the tightness of the cable guide it's recommended to use flexible electric cables suitable for exterior use.

Optic Spot 14°

Power Led: 12W - 2x574 lm \neq OUTPUT 2x439 lm - 2700K/CRI 80 - 110 \pm 240V / 12W - 2x617 lm \neq OUTPUT 2x472 lm - 3000K/CRI 80 - 110 \pm 240V / 12W - 2x649 lm \neq OUTPUT 2x488 lm - 4000K/CRI 80 - 110 \pm 240V

- | | | |
|----------------|----------------|-----------------|
| 2700K | 3000K | 4000K |
| ○ FA1162711301 | ○ FA1165611301 | ○ FA11617211301 |
| ● FA1162711306 | ● FA1165611306 | ● FA11617211306 |
| ● FA1162711312 | ● FA1165611312 | ● FA11617211312 |
| ● FA1162711318 | ● FA1165611318 | ● FA11617211318 |
| ● FA1162711330 | ● FA1165611330 | ● FA11617211330 |
| ● FA1162711333 | ● FA1165611333 | ● FA11617211333 |

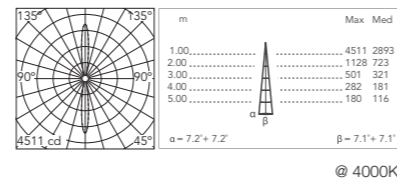

Optic Medium 54°

Power Led: 12W - 2x574 lm \neq OUTPUT 2x392 lm - 2700K/CRI 80 - 110 \pm 240V / 12W - 2x617 lm \neq OUTPUT 2x422 lm - 3000K/CRI 80 - 110 \pm 240V / 12W - 2x649 lm \neq OUTPUT 2x436 lm - 4000K/CRI 80 - 110 \pm 240V

- | | | |
|---------------|---------------|----------------|
| 2700K | 3000K | 4000K |
| ○ FA116274201 | ○ FA116564201 | ○ FA1161724201 |
| ● FA116274206 | ● FA116564206 | ● FA1161724206 |
| ● FA116274212 | ● FA116564212 | ● FA1161724212 |
| ● FA116274218 | ● FA116564218 | ● FA1161724218 |
| ● FA116274230 | ● FA116564230 | ● FA1161724230 |
| ● FA116274233 | ● FA116564233 | ● FA1161724233 |

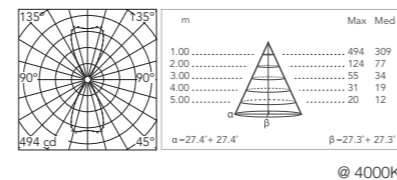

Emma Wall 3 Mono

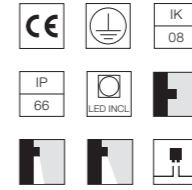
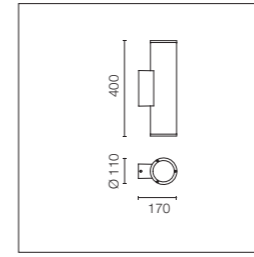

Sorgente a LED inclusa. Alimentazione elettrica 220-240V ON/ OFF integrata. Dotata di due passacavi IP65, per cavi in gomma 8mm< ϕ <12mm e una morsettiere a connessione rapida. Per garantire la tenuta del passacavo è consigliabile utilizzare cavi elettrici flessibili idonei all'impiego in ambienti esterni.

LED source included. Electrical power supply 220-240V ON/ OFF. With IP65 cable guide for rubber cables 8mm< ϕ <12mm and a connection box for fast connections. To ensure the tightness of the cable guide it's recommended to use flexible electric cables suitable for exterior use.

Optic Spot 20°

CoB Led: 14,5W - 1895 lm \neq OUTPUT 1569 lm - 2700K/CRI 80 - 220 \pm 240V / 14,5W - 2038 lm \neq OUTPUT 1687 lm - 3000K/CRI 80 - 220 \pm 240V / 14,5W - 2123 lm \neq OUTPUT 1757 lm - 4000K/CRI 80 - 220 \pm 240V

- | | | |
|-----------------|-----------------|-----------------|
| 2700K | 3000K | 4000K |
| ○ FA11727914601 | ○ FA11726914601 | ○ FA11726814601 |
| ● FA11727914606 | ● FA11726914606 | ● FA11726814606 |
| ● FA11727914612 | ● FA11726914612 | ● FA11726814612 |
| ● FA11727914618 | ● FA11726914618 | ● FA11726814618 |
| ● FA11727914630 | ● FA11726914630 | ● FA11726814630 |
| ● FA11727914633 | ● FA11726914633 | ● FA11726814633 |

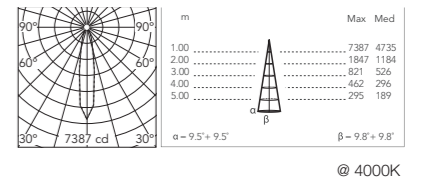

Optic Medium 38°

CoB Led: 14,5W - 1895 lm \neq OUTPUT 1526 lm - 2700K/CRI 80 - 220 \pm 240V / 14,5W - 2038 lm \neq OUTPUT 1641 lm - 3000K/CRI 80 - 220 \pm 240V / 14,5W - 2123 lm \neq OUTPUT 1709 lm - 4000K/CRI 80 - 220 \pm 240V

- | | | |
|-----------------|-----------------|-----------------|
| 2700K | 3000K | 4000K |
| ○ FA11727914701 | ○ FA11726914701 | ○ FA11726814701 |
| ● FA11727914706 | ● FA11726914706 | ● FA11726814706 |
| ● FA11727914712 | ● FA11726914712 | ● FA11726814712 |
| ● FA11727914718 | ● FA11726914718 | ● FA11726814718 |
| ● FA11727914730 | ● FA11726914730 | ● FA11726814730 |
| ● FA11727914733 | ● FA11726914733 | ● FA11726814733 |

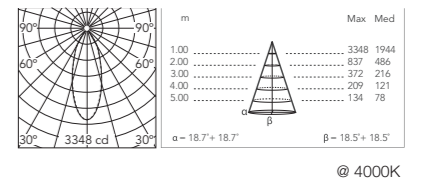

Emma Wall 3 Double

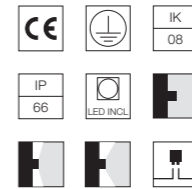
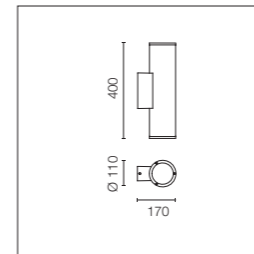

Sorgente a LED inclusa. Alimentazione elettrica 220-240V ON/ OFF integrata. Dotata di due passacavi IP65, per cavi in gomma 8mm< ϕ <12mm e una morsettiere a connessione rapida. Per garantire la tenuta del passacavo è consigliabile utilizzare cavi elettrici flessibili idonei all'impiego in ambienti esterni.

LED source included. Electrical power supply 220-240V ON/ OFF. With IP65 cable guide for rubber cables 8mm< ϕ <12mm and a connection box for fast connections. To ensure the tightness of the cable guide it's recommended to use flexible electric cables suitable for exterior use.

Optic Spot 20°

CoB Led: 27W - 2x1895 lm \neq OUTPUT 2x1569 lm - 2700K/CRI 80 - 220 \pm 240V / 27W - 2x2038 lm \neq OUTPUT 2x1687 lm - 3000K/CRI 80 - 220 \pm 240V / 27W - 2x2123 lm \neq OUTPUT 2x1757 lm - 4000K/CRI 80 - 220 \pm 240V

- | | | |
|-----------------|-----------------|-----------------|
| 2700K | 3000K | 4000K |
| ○ FA11727914801 | ○ FA11726914801 | ○ FA11726814801 |
| ● FA11727914806 | ● FA11726914806 | ● FA11726814806 |
| ● FA11727914812 | ● FA11726914812 | ● FA11726814812 |
| ● FA11727914818 | ● FA11726914818 | ● FA11726814818 |
| ● FA11727914830 | ● FA11726914830 | ● FA11726814830 |
| ● FA11727914833 | ● FA11726914833 | ● FA11726814833 |

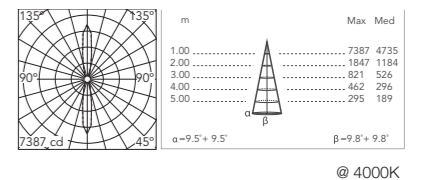

Optic Medium 38°

CoB Led: 27W - 2x1895 lm \neq OUTPUT 2x1526 lm - 2700K/CRI 80 - 220 \pm 240V / 27W - 2x2038 lm \neq OUTPUT 2x1641 lm - 3000K/CRI 80 - 220 \pm 240V / 27W - 2x2123 lm \neq OUTPUT 2x1709 lm - 4000K/CRI 80 - 220 \pm 240V

- | | | |
|-----------------|-----------------|-----------------|
| 2700K | 3000K | 4000K |
| ○ FA11727914901 | ○ FA11726914901 | ○ FA11726814901 |
| ● FA11727914906 | ● FA11726914906 | ● FA11726814906 |
| ● FA11727914912 | ● FA11726914912 | ● FA11726814912 |
| ● FA11727914918 | ● FA11726914918 | ● FA11726814918 |
| ● FA11727914930 | ● FA11726914930 | ● FA11726814930 |
| ● FA11727914933 | ● FA11726914933 | ● FA11726814933 |

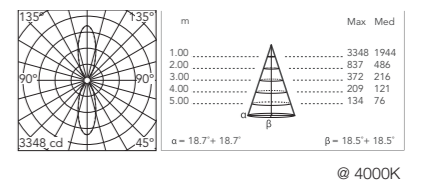

Emma Wall 4 Mono

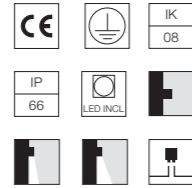
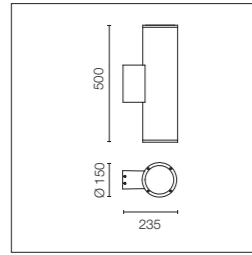

Sorgente a LED inclusa.
Alimentazione elettrica 220-240V ON/ OFF integrata. Dotata di due passacavi IP65, per cavi in gomma 8mmϕ<math><12\text{mm}</math> e una morsettiera a connessione rapida. Per garantire la tenuta del passacavo è consigliabile utilizzare cavi elettrici flessibili idonei all'impiego in ambienti esterni.

LED source included. Electrical power supply 220-240V ON/OFF. With IP65 cable guide for rubber cables 8mmϕ<math><12\text{mm}</math> and a connection box for fast connections. To ensure the tightness of the cable guide it's recommended to use flexible electric cables suitable for exterior use.

Optic Spot 18°

CoB Led: 20W - 2744 lm \neq OUTPUT 2121 lm - 2700K/CRI 80 - 220÷240V / 20W - 2950 lm \neq OUTPUT 2281 lm - 3000K/CRI 80 - 220÷240V / 20W - 3080 lm \neq OUTPUT 2382 lm - 4000K/CRI 80 - 220÷240V

2700K

- FA11828215001
- FA11828215006
- FA11828215012
- FA11828215018
- FA11828215030
- FA11828215033

3000K

- FA11827215001
- FA11827215006
- FA11827215012
- FA11827215018
- FA11827215030
- FA11827215033

4000K

- FA11827115001
- FA11827115006
- FA11827115012
- FA11827115018
- FA11827115030
- FA11827115033

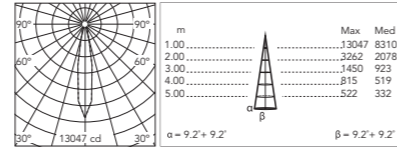

@ 4000K

Optic Medium 42°

CoB Led: 20W - 2744 lm \neq OUTPUT 2030 lm - 2700K/CRI 80 - 220÷240V / 20W - 2950 lm \neq OUTPUT 2183 lm - 3000K/CRI 80 - 220÷240V / 20W - 3080 lm \neq OUTPUT 2279 lm - 4000K/CRI 80 - 220÷240V

2700K

- FA11828215101
- FA11828215106
- FA11828215112
- FA11828215118
- FA11828215130
- FA11828215133

3000K

- FA11827215101
- FA11827215106
- FA11827215112
- FA11827215118
- FA11827215130
- FA11827215133

4000K

- FA11827115101
- FA11827115106
- FA11827115112
- FA11827115118
- FA11827115130
- FA11827115133

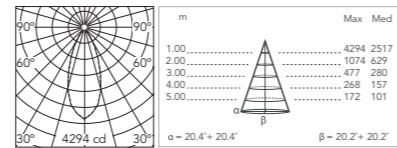

@ 4000K

Emma Wall 4 Double

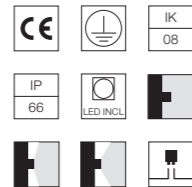
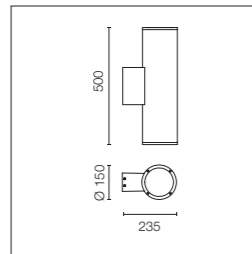

Sorgente a LED inclusa.
Alimentazione elettrica 220-240V ON/ OFF integrata. Dotata di due passacavi IP65, per cavi in gomma 8mmϕ<math><12\text{mm}</math> e una morsettiera a connessione rapida. Per garantire la tenuta del passacavo è consigliabile utilizzare cavi elettrici flessibili idonei all'impiego in ambienti esterni.

LED source included. Electrical power supply 220-240V ON/OFF. With IP65 cable guide for rubber cables 8mmϕ<math><12\text{mm}</math> and a connection box for fast connections. To ensure the tightness of the cable guide it's recommended to use flexible electric cables suitable for exterior use.

Optic Spot 18°

CoB Led: 39W - 2x2744 lm \neq OUTPUT 2x2121 lm - 2700K/CRI 80 - 220÷240V / 39W - 2x2950 lm \neq OUTPUT 2x2281 lm - 3000K/CRI 80 - 220÷240V / 39W - 2x3080 lm \neq OUTPUT 2x2382 lm - 4000K/CRI 80 - 220÷240V

2700K

- FA11828215201
- FA11828215206
- FA11828215212
- FA11828215218
- FA11828215230
- FA11828215233

3000K

- FA11827215201
- FA11827215206
- FA11827215212
- FA11827215218
- FA11827215230
- FA11827215233

4000K

- FA11827115201
- FA11827115206
- FA11827115212
- FA11827115218
- FA11827115230
- FA11827115233

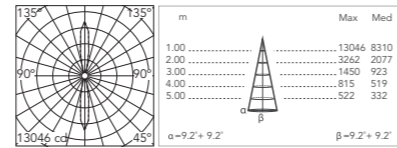

@ 4000K

Optic Medium 42°

CoB Led: 39W - 2x2744 lm \neq OUTPUT 2x2030 lm - 2700K/CRI 80 - 220÷240V / 39W - 2x2950 lm \neq OUTPUT 2x2183 lm - 3000K/CRI 80 - 220÷240V / 39W - 2x3080 lm \neq OUTPUT 2x2279 lm - 4000K/CRI 80 - 220÷240V

2700K

- FA11828215301
- FA11828215306
- FA11828215312
- FA11828215318
- FA11828215330
- FA11828215333

3000K

- FA11827215301
- FA11827215306
- FA11827215312
- FA11827215318
- FA11827215330
- FA11827215333

4000K

- FA11827115301
- FA11827115306
- FA11827115312
- FA11827115318
- FA11827115330
- FA11827115333

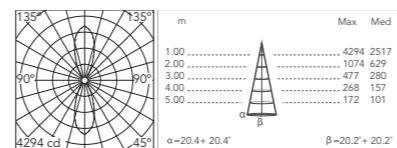

@ 4000K

Emma Wall: Accessori / Accessories

Sistema di giunzione IP68 a vie 4 poli. (ø7=12mm cavo).

2 way terminal block 4 poles IP68. (ø7=12mm cable).

F990C040000



Emma Ceiling 2

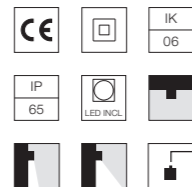
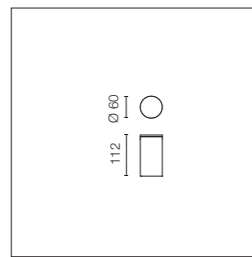

Sorgente a LED inclusa. Alimentazione elettrica 220-240V ON/ OFF integrata. Dotata di passacavo IP65, per cavi in gomma 5mmϕ<math><9\text{mm}</math> e una morsettiera a connessione rapida. Per garantire la tenuta del passacavo è consigliabile utilizzare cavi elettrici flessibili idonei all'impiego in ambienti esterni.

LED source included. Integrated electrical power supply 220-240V ON/OFF. With IP65 cable guide for rubber cables 5mmϕ<math><9\text{mm}</math> and a connection box for fast connections. To ensure the tightness of the cable guide it's recommended to use flexible electric cables suitable for exterior use.

Optic Spot 15°

Power Led: 6W - 442 lm \neq OUTPUT 396 lm - 2700K/CRI 80 - 220 \pm 240V / 6W - 475 lm \neq OUTPUT 426 lm - 2700K/CRI 80 - 220 \pm 240V / 6W - 510 lm \neq OUTPUT 458 lm - 4000K/CRI 80 - 220 \pm 240V

- | | | |
|--------------|--------------|--------------|
| 2700K | 3000K | 4000K |
| ○ FA53124201 | ○ FA53104201 | ○ FA53104101 |
| ● FA53124206 | ● FA53104206 | ● FA53104106 |
| ● FA53124212 | ● FA53104212 | ● FA53104112 |
| ● FA53124218 | ● FA53104218 | ● FA53104118 |
| ● FA53124230 | ● FA53104230 | ● FA53104130 |
| ● FA53124233 | ● FA53104233 | ● FA53104133 |

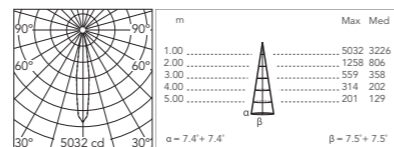

@ 4000K

Optic Flood 65°

Power Led: 6W - 442 lm \neq OUTPUT 314 lm - 2700K/CRI 80 - 220 \pm 240V / 6W - 475 lm \neq OUTPUT 338 lm - 2700K/CRI 80 - 220 \pm 240V / 6W - 510 lm \neq OUTPUT 363 lm - 4000K/CRI 80 - 220 \pm 240V

- | | | |
|--------------|--------------|--------------|
| 2700K | 3000K | 4000K |
| ○ FA53124401 | ○ FA53104401 | ○ FA53104301 |
| ● FA53124406 | ● FA53104406 | ● FA53104306 |
| ● FA53124412 | ● FA53104412 | ● FA53104312 |
| ● FA53124418 | ● FA53104418 | ● FA53104318 |
| ● FA53124430 | ● FA53104430 | ● FA53104330 |
| ● FA53124433 | ● FA53104433 | ● FA53104333 |

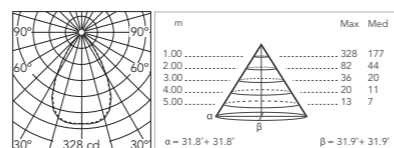

@ 4000K

Emma Ceiling 3 Direct Voltage

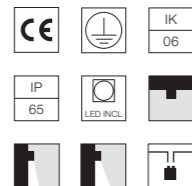
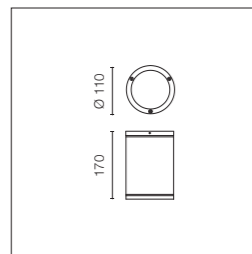

Sorgente a LED inclusa. Modulo Led configurato per lavorare direttamente alla rete elettrica 220-230V ON/ OFF. Dotata di due passacavi IP65, per cavi in gomma 5mmϕ<math><9\text{mm}</math> e una morsettiera a connessione rapida. Per garantire la tenuta del passacavo è consigliabile utilizzare cavi elettrici flessibili idonei all'impiego in ambienti esterni.

LED source included. LED module configured to work directly on the mains 220-230V ON/OFF. With IP65 cable guide for rubber cables 5mmϕ<math><9\text{mm}</math> and a connection box for fast connections. To ensure the tightness of the cable guide it's recommended to use flexible electric cables suitable for exterior use.

Optic Spot 20°

CoB Led: 12W - 951 lm \neq OUTPUT 752 lm - 3000K/CRI 80 - 220 \pm 230V

- | |
|--------------|
| 3000K |
| ○ FA53102901 |
| ● FA53102906 |
| ● FA53102912 |
| ● FA53102918 |
| ● FA53102930 |
| ● FA53102933 |

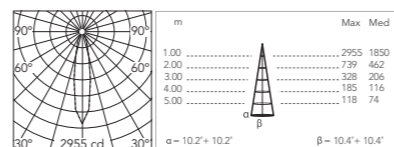

@ 3000K

Optic Medium 30°

CoB Led: 12W - 951 lm \neq OUTPUT 713 lm - 3000K/CRI 80 - 220 \pm 230V

- | |
|--------------|
| 3000K |
| ○ FA53103001 |
| ● FA53103006 |
| ● FA53103012 |
| ● FA53103018 |
| ● FA53103030 |
| ● FA53103033 |

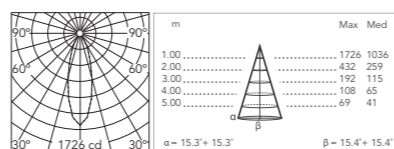

@ 3000K

Emma Ceiling 3

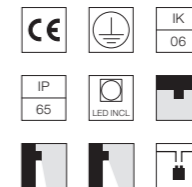
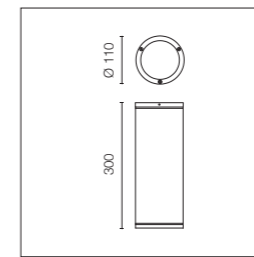

Sorgente a LED inclusa. Alimentazione elettrica 220-240V ON/ OFF e dimmerabile 1-10V o DALI integrata. Dotata di due passacavi IP65, per cavi in gomma 5mmϕ<math><9\text{mm}</math> e una morsettiera a connessione rapida. Per garantire la tenuta del passacavo è consigliabile utilizzare cavi elettrici flessibili idonei all'impiego in ambienti esterni.

LED source included. Integrated power supply 220-230V ON/OFF and dimmable 1-10V or DALI. With IP65 cable guide for rubber cables 5mmϕ<math><9\text{mm}</math> and a connection box for fast connections. To ensure the tightness of the cable guide it's recommended to use flexible electric cables suitable for exterior use.

Optic Spot 20°

CoB Led: 15W - 1622 lm \neq OUTPUT 1455 lm - 2700K/CRI 80 - 220 \pm 240V / 15W - 1744 lm \neq OUTPUT 1564 lm - 2700K/CRI 80 - 220 \pm 240V / 15W - 1829 lm \neq OUTPUT 1641 lm - 4000K/CRI 80 - 220 \pm 240V

- | | | |
|------------------|------------------|------------------|
| 2700K | 3000K | 4000K |
| Non Dimmable | Non Dimmable | Non Dimmable |
| ○ FA53121201 | ○ FA53101201 | ○ FA53101101 |
| ● FA53121206 | ● FA53101206 | ● FA53101106 |
| ● FA53121212 | ● FA53101212 | ● FA53101112 |
| ● FA53121218 | ● FA53101218 | ● FA53101118 |
| ● FA53121230 | ● FA53101230 | ● FA53101130 |
| ● FA53121233 | ● FA53101233 | ● FA53101133 |
| 1-10V | 1-10V | 1-10V |
| ○ FA53121201-310 | ○ FA53101201-310 | ○ FA53101101-310 |
| ● FA53121206-310 | ● FA53101206-310 | ● FA53101106-310 |
| ● FA53121212-310 | ● FA53101212-310 | ● FA53101112-310 |
| ● FA53121218-310 | ● FA53101218-310 | ● FA53101118-310 |
| ● FA53121230-310 | ● FA53101230-310 | ● FA53101130-310 |
| ● FA53121233-310 | ● FA53101233-310 | ● FA53101133-310 |
| Dali | Dali | Dali |
| ○ FA53121201-300 | ○ FA53101201-300 | ○ FA53101101-300 |
| ● FA53121206-300 | ● FA53101206-300 | ● FA53101106-300 |
| ● FA53121212-300 | ● FA53101212-300 | ● FA53101112-300 |
| ● FA53121218-300 | ● FA53101218-300 | ● FA53101118-300 |
| ● FA53121230-300 | ● FA53101230-300 | ● FA53101130-300 |
| ● FA53121233-300 | ● FA53101233-300 | ● FA53101133-300 |

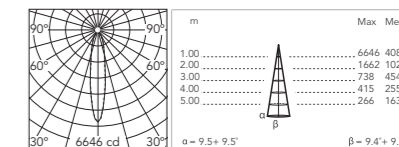

@ 4000K

Optic Medium 40°

CoB Led: 15W - 1622 lm \neq OUTPUT 1443 lm - 2700K/CRI 80 - 220 \pm 240V / 15W - 1744 lm \neq OUTPUT 1552 lm - 2700K/CRI 80 - 220 \pm 240V / 15W - 1829 lm \neq OUTPUT 1628 lm - 4000K/CRI 80 - 220 \pm 240V

- | | | |
|------------------|------------------|------------------|
| 2700K | 3000K | 4000K |
| Non Dimmable | Non Dimmable | Non Dimmable |
| ○ FA53120901 | ○ FA53100901 | ○ FA53100801 |
| ● FA53120906 | ● FA53100906 | ● FA53100806 |
| ● FA53120912 | ● FA53100912 | ● FA53100812 |
| ● FA53120918 | ● FA53100918 | ● FA53100818 |
| ● FA53120930 | ● FA53100930 | ● FA53100830 |
| ● FA53120933 | ● FA53100933 | ● FA53100833 |
| 1-10V | 1-10V | 1-10V |
| ○ FA53120901-310 | ○ FA53100901-310 | ○ FA53100801-310 |
| ● FA53120906-310 | ● FA53100906-310 | ● FA53100806-310 |
| ● FA53120912-310 | ● FA53100912-310 | ● FA53100812-310 |
| ● FA53120918-310 | ● FA53100918-310 | ● FA53100818-310 |
| ● FA53120930-310 | ● FA53100930-310 | ● FA53100830-310 |
| ● FA53120933-310 | ● FA53100933-310 | ● FA53100833-310 |
| Dali | Dali | Dali |
| ○ FA53120901-300 | ○ FA53100901-300 | ○ FA53100801-300 |
| ● FA53120906-300 | ● FA53100906-300 | ● FA53100806-300 |
| ● FA53120912-300 | ● FA53100912-300 | ● FA53100812-300 |
| ● FA53120918-300 | ● FA53100918-300 | ● FA53100818-300 |
| ● FA53120930-300 | ● FA53100930-300 | ● FA53100830-300 |
| ● FA53120933-300 | ● FA53100933-300 | ● FA53100833-300 |

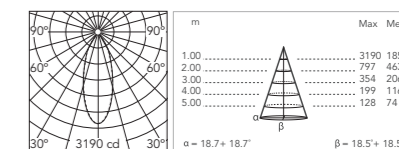

@ 4000K

Emma Ceiling 4 Direct Voltage

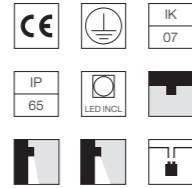
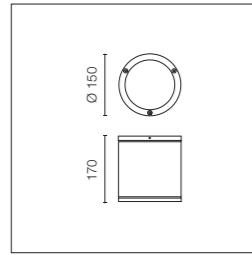

Sorgente a LED inclusa. Modulo Led configurato per lavorare direttamente alla rete elettrica 220-230V ON/ OFF. Dotata di due passacavi IP65, per cavi in gomma 5mm< ϕ <9mm e una morsettiera a connessione rapida. Per garantire la tenuta del passacavo è consigliabile utilizzare cavi elettrici flessibili idonei all'impiego in ambienti esterni.

LED source included. LED module configured to work directly on the mains 220-230V ON/OFF. With IP65 cable guide for rubber cables 5mm< ϕ <9mm and a connection box for fast connections. To ensure the tightness of the cable guide it's recommended to use flexible electric cables suitable for exterior use.

Optic Spot 20°

CoB Led: 24W - 2303 lm \neq OUTPUT 1659 lm - 3000K/CRI 80 - 220 \pm 230V

3000K

- FA53103101
- FA53103106
- FA53103112
- FA53103118
- FA53103130
- FA53103133

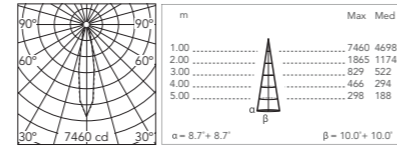

Optic Medium 40°

CoB Led: 24W - 2303 lm \neq OUTPUT 1610 lm - 3000K/CRI 80 - 220 \pm 230V

3000K

- FA53103201
- FA53103206
- FA53103212
- FA53103218
- FA53103230
- FA53103233

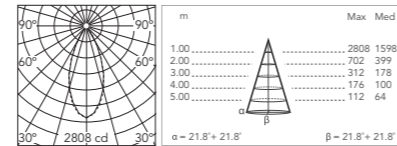

Emma Ceiling 4

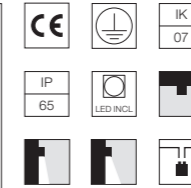
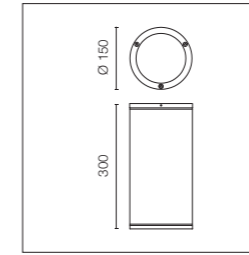

Sorgente a LED inclusa. Alimentazione elettrica 220-240V ON/ OFF e dimmerabile 1-10V o DALI integrata. Dotata di due passacavi IP65, per cavi in gomma 5mm< ϕ <9mm e una morsettiera a connessione rapida. Per garantire la tenuta del passacavo è consigliabile utilizzare cavi elettrici flessibili idonei all'impiego in ambienti esterni.

LED source included. Integrated power supply 220-230V ON/OFF and dimmable 1-10V or DALI. With IP65 cable guide for rubber cables 5mm< ϕ <9mm and a connection box for fast connections. To ensure the tightness of the cable guide it's recommended to use flexible electric cables suitable for exterior use.

Optic Spot 20°

CoB Led: 20W - 2387 lm \neq OUTPUT 1907 lm - 2700K/CRI 80 - 220 \pm 240V / 20W - 2567 lm \neq OUTPUT 2050 lm - 2700K/CRI 80 - 220 \pm 240V / 20W - 2632 lm \neq OUTPUT 2102 lm - 4000K/CRI 80 - 220 \pm 240V

2700K

Non Dimmable

- FA53122401
- FA53122406
- FA53122412
- FA53122418
- FA53122430
- FA53122433

1-10V

- FA53122401-310
- FA53122406-310
- FA53122412-310
- FA53122418-310
- FA53122430-310
- FA53122433-310

Dali

- FA53122401-300
- FA53122406-300
- FA53122412-300
- FA53122418-300
- FA53122430-300
- FA53122433-300

3000K

Non Dimmable

- FA53102401
- FA53102406
- FA53102412
- FA53102418
- FA53102430
- FA53102433

1-10V

- FA53102401-310
- FA53102406-310
- FA53102412-310
- FA53102418-310
- FA53102430-310
- FA53102433-310

Dali

- FA53102401-300
- FA53102406-300
- FA53102412-300
- FA53102418-300
- FA53102430-300
- FA53102433-300

4000K

Non Dimmable

- FA53102501
- FA53102506
- FA53102512
- FA53102518
- FA53102530
- FA53102533

1-10V

- FA53102501-310
- FA53102506-310
- FA53102512-310
- FA53102518-310
- FA53102530-310
- FA53102533-310

Dali

- FA53102501-300
- FA53102506-300
- FA53102512-300
- FA53102518-300
- FA53102530-300
- FA53102533-300

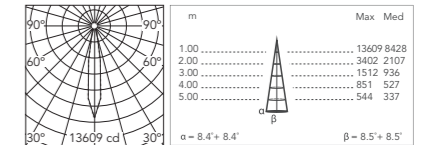

@ 4000K

Optic Medium 40°

CoB Led: 20W - 2387 lm \neq OUTPUT 1923 lm - 2700K/CRI 80 - 220 \pm 240V / 20W - 2567 lm \neq OUTPUT 2068 lm - 2700K/CRI 80 - 220 \pm 240V / 20W - 2632 lm \neq OUTPUT 2121 lm - 4000K/CRI 80 - 220 \pm 240V

2700K

Non Dimmable

- FA53122101
- FA53122106
- FA53122112
- FA53122118
- FA53122130
- FA53122133

1-10V

- FA53122101-310
- FA53122106-310
- FA53122112-310
- FA53122118-310
- FA53122130-310
- FA53122133-310

Dali

- FA53122101-300
- FA53122106-300
- FA53122112-300
- FA53122118-300
- FA53122130-300
- FA53122133-300

3000K

Non Dimmable

- FA53102101
- FA53102106
- FA53102112
- FA53102118
- FA53102130
- FA53102133

1-10V

- FA53102101-310
- FA53102106-310
- FA53102112-310
- FA53102118-310
- FA53102130-310
- FA53102133-310

Dali

- FA53102101-300
- FA53102106-300
- FA53102112-300
- FA53102118-300
- FA53102130-300
- FA53102133-300

4000K

Non Dimmable

- FA53102001
- FA53102006
- FA53102012
- FA53102018
- FA53102030
- FA53102033

1-10V

- FA53102001-310
- FA53102006-310
- FA53102012-310
- FA53102018-310
- FA53102030-310
- FA53102033-310

Dali

- FA53102001-300
- FA53102006-300
- FA53102012-300
- FA53102018-300
- FA53102030-300
- FA53102033-300

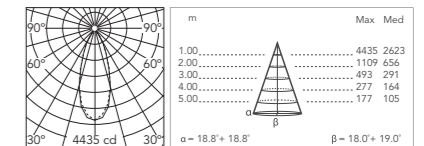

@ 4000K

Emma: Accessori / Accessories

Dispositivo di protezione per il sovraccarico. 275Vac. Corrente massima di scarica 10KA (8/29 μ s). Massima corrente operativa 5A. Adatto per la connessione in serie. IP66.

Surge protection device. 275Vac. Maximum discharge current 10KA (8/20 μ s). Maximum operating current 5A. Suitable for series connection. IP66.

LED Lamps
F990E00A000

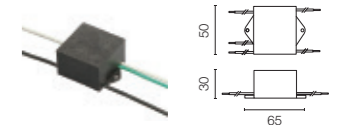

Leila





Famiglia / Family

Leila 1



CoB Led

up to 12W
up to 646 lm - 2700K/CRI 80
up to 695 lm - 3000K/CRI 80
up to 723 lm - 4000K/CRI 80

* Net lumen output

Leila 2



CoB Led

up to 16W
up to 1072 lm - 2700K/CRI 80
up to 1153 lm - 3000K/CRI 80
up to 1210 lm - 4000K/CRI 80

* Net lumen output

Leila 3



CoB Led

up to 30W
up to 2566 lm - 2700K/CRI 80
up to 2759 lm - 3000K/CRI 80
up to 2894 lm - 4000K/CRI 80

* Net lumen output

Leila 4



CoB Led

up to 43W
up to 3076 lm - 2700K/CRI 80
up to 3302 lm - 3000K/CRI 80
up to 3392 lm - 4000K/CRI 80

* Net lumen output

Descrizione / Description

Famiglia di apparecchi di illuminazione con sorgente luminosa a LED per installazione a incasso a soffitto e controsoffitto in cartongesso, caratterizzati dalla forma circolare declinata in quattro dimensioni. Disponibile in diverse aperture di fascio per dimensioni. Corpo dell'apparecchio in alluminio pressofuso lega EN AB 47100 (a basso contenuto di rame), ghiera esterna in acciaio inox AISI 316L pallinato o verniciato in colore bianco opaco. Diffusore in vetro testurizzato con bordo serigrafato, fissato all'apparecchio tramite incollaggio robotizzato. Le viterie di fissaggio sono in acciaio inox AISI 316L. L'apparecchio è dotato di un connettore a vite M12 a tenuta stagna che fornisce isolamento ottimale contro la penetrazione di acqua e rapido collegamento con l'unità di cablaggio. L'alimentatore è in dotazione con l'apparecchio come un kit IP67 remoto da alloggiare nella cassaforma da incasso in caso di soffitto in muratura o direttamente appoggiato in prossimità dell'apparecchio in caso di controsoffitto. Disponibile come accessorio opzionale la cassaforma in metallo da murare in caso di soffitto in muratura o cemento armato.

Luminaire family with LED source for recessed ceiling and plaster-board false ceiling mounting. Defined by their round shape. Available in four dimensions and different beam angles per dimension. EN AB-47100 die cast aluminum body (with low copper content), AISI 316L stainless steel outer lid, shot-blasted and varnished in matte white. Textured glass diffuser with silkscreen edge, attached to the luminaire with a robotic gluing system. The fixing screws are made of stainless steel AISI 316L. Equipped with a watertight M12 threaded connector that prevents water infiltration and facilitates quick connection to the wiring unit. The power supply is supplied together with a remote IP67 kit to be housed in the junction box in case of recessed installation in a masonry ceiling, or supported directly near the luminaire, in case of recessed installation in a false ceiling. The metal junction box to be recessed in case of installation in masonry or reinforced concrete ceilings is available as an accessory.

Colori / Colours



01 White



56 Matt Stainless Steel

Leila 1

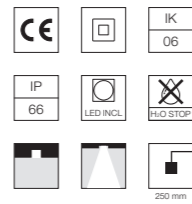
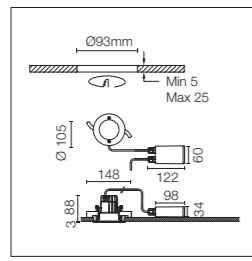

Sorgente a LED inclusa. Alimentazione elettrica 220-240V ON/OFF: kit remoto dotato di spezzone di cavo 400mm con connettore a vite M12 a tenuta stagna all'apparecchio e di uno spezzone di cavo 250mm per il collegamento alla linea elettrica, da alloggiare in cassaforma da ordinare separatamente per soffitto in muratura, o da appoggiare in prossimità per controsoffitto in cartongesso. Versione dimmerabile a richiesta.

LED source included. Electrical power supply 220-240V ON/OFF: remote kit with a 400mm cable section with watertight threaded M12 connector on the luminaire and a 250mm cable section for connection on the mains. This needs to be housed in the junction box for masonry ceilings (it needs to be ordered separately) or set next to the luminaire in case of plasterboard false ceilings. Dimmable version available upon request.

Optic Spot 20°

CoB Led: 12W - 1143 lm ≠ OUTPUT 646 lm - 2700K/CRI 80 - 220÷240V / 12W - 1229 lm ≠ OUTPUT 695 lm - 3000K/CRI 80 - 220÷240V / 12W - 1278 lm ≠ OUTPUT 723 lm - 4000K/CRI 80 - 220÷240V

- | | | |
|--------------|--------------|--------------|
| 2700K | 3000K | 4000K |
| ○ FA53610901 | ○ FA53600901 | ○ FA53600801 |
| ● FA53610356 | ● FA53600356 | ● FA53600256 |

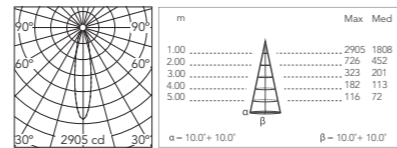

@ 4000K

Optic Medium 45°

CoB Led: 12W - 1143 lm ≠ OUTPUT 802 lm - 2700K/CRI 80 - 220÷240V / 12W - 1229 lm ≠ OUTPUT 862 lm - 3000K/CRI 80 - 220÷240V / 12W - 1278 lm ≠ OUTPUT 896 lm - 4000K/CRI 80 - 220÷240V

- | | | |
|--------------|--------------|--------------|
| 2700K | 3000K | 4000K |
| ○ FA53611201 | ○ FA53601201 | ○ FA53601101 |
| ● FA53610656 | ● FA53600656 | ● FA53600556 |

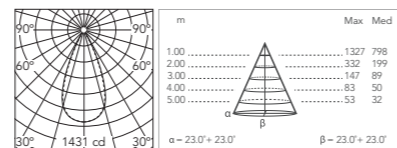

@ 4000K

Leila 2

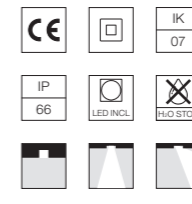
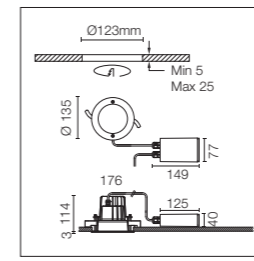

Sorgente a LED inclusa. Alimentazione elettrica 220-240V ON/OFF e dimmerabile 1-10V o DALI integrata: kit remoto dotato di spezzone di cavo 400mm con connettore a vite M12 a tenuta stagna all'apparecchio e di uno spezzone di cavo 250mm per il collegamento alla linea elettrica, da alloggiare in cassaforma da ordinare separatamente per soffitto in muratura, o da appoggiare in prossimità per controsoffitto in cartongesso.

LED source included. Integrated power supply 220-240V ON/OFF and dimmable 1-10V or DALI: remote kit with a 400mm cable section with watertight threaded M12 connector on the luminaire and a 250mm cable section for connection on the mains. This needs to be housed in the junction box for masonry ceilings (it needs to be ordered separately) or set next to the luminaire in case of plasterboard false ceilings. Dimmable version available upon request.

Optic Spot 20°

CoB Led: 16W - 1622 lm ≠ OUTPUT 1072 lm - 2700K/CRI 80 - 220÷240V / 16W - 1744 lm ≠ OUTPUT 1153 lm - 3000K/CRI 80 - 220÷240V / 16W - 1829 lm ≠ OUTPUT 1210 lm - 4000K/CRI 80 - 220÷240V

- | | | |
|------------------|------------------|------------------|
| 2700K | 3000K | 4000K |
| Non Dimmable | Non Dimmable | Non Dimmable |
| ○ FA53612201 | ○ FA53602201 | ○ FA53602101 |
| ● FA53611456 | ● FA53601456 | ● FA53601356 |
| 1-10V | 1-10V | 1-10V |
| ○ FA53612201-310 | ○ FA53602201-310 | ○ FA53602101-310 |
| ● FA53611456-310 | ● FA53601456-310 | ● FA53601356-310 |
| Dali | Dali | Dali |
| ○ FA53612201-300 | ○ FA53602201-300 | ○ FA53602101-300 |
| ● FA53611456-300 | ● FA53601456-300 | ● FA53601356-300 |

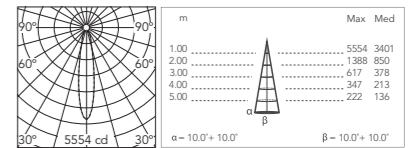

@ 4000K

Optic Medium 40°

CoB Led: 16W - 1622 lm ≠ OUTPUT 1093 lm - 2700K/CRI 80 - 220÷240V / 16W - 1744 lm ≠ OUTPUT 1175 lm - 3000K/CRI 80 - 220÷240V / 16W - 1829 lm ≠ OUTPUT 1232 lm - 4000K/CRI 80 - 220÷240V

- | | | |
|------------------|------------------|------------------|
| 2700K | 3000K | 4000K |
| Non Dimmable | Non Dimmable | Non Dimmable |
| ○ FA53612401 | ○ FA53602401 | ○ FA53602301 |
| ● FA53611656 | ● FA53601656 | ● FA53601556 |
| 1-10V | 1-10V | 1-10V |
| ○ FA53612401-310 | ○ FA53602401-310 | ○ FA53602301-310 |
| ● FA53611656-310 | ● FA53601656-310 | ● FA53601556-310 |
| Dali | Dali | Dali |
| ○ FA53612401-300 | ○ FA53602401-300 | ○ FA53602301-300 |
| ● FA53611656-300 | ● FA53601656-300 | ● FA53601556-300 |

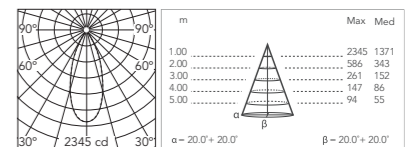

@ 4000K

Asymmetric Optic 12° - 20°

CoB Led: 16W - 1535 lm ≠ OUTPUT 908 lm - 2700K/CRI 80 - 220÷240V / 16W - 1650 lm ≠ OUTPUT 976 lm - 3000K/CRI 80 - 220÷240V / 16W - 1716 lm ≠ OUTPUT 1015 lm - 4000K/CRI 80 - 220÷240V

- | | | |
|------------------|------------------|------------------|
| 2700K | 3000K | 4000K |
| Non Dimmable | Non Dimmable | Non Dimmable |
| ○ FA53612601 | ○ FA53602601 | ○ FA53602501 |
| ● FA53611856 | ● FA53601856 | ● FA53601756 |
| 1-10V | 1-10V | 1-10V |
| ○ FA53612601-310 | ○ FA53602601-310 | ○ FA53602501-310 |
| ● FA53611856-310 | ● FA53601856-310 | ● FA53601756-310 |
| Dali | Dali | Dali |
| ○ FA53612601-300 | ○ FA53602601-300 | ○ FA53602501-300 |
| ● FA53611856-300 | ● FA53601856-300 | ● FA53601756-300 |

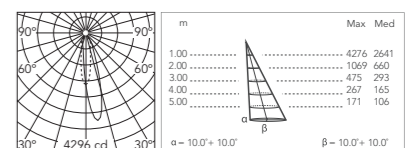

@ 4000K

Asymmetric Optic 12° - 45°

CoB Led: 16W - 1535 lm ≠ OUTPUT 1126 lm - 2700K/CRI 80 - 220÷240V / 16W - 1650 lm ≠ OUTPUT 1211 lm - 3000K/CRI 80 - 220÷240V / 16W - 1716 lm ≠ OUTPUT 1259 lm - 4000K/CRI 80 - 220÷240V

- | | | |
|------------------|------------------|------------------|
| 2700K | 3000K | 4000K |
| Non Dimmable | Non Dimmable | Non Dimmable |
| ○ FA53612801 | ○ FA53602801 | ○ FA53602701 |
| ● FA53612056 | ● FA53602056 | ● FA53601956 |
| 1-10V | 1-10V | 1-10V |
| ○ FA53612801-310 | ○ FA53602801-310 | ○ FA53602701-310 |
| ● FA53612056-310 | ● FA53602056-310 | ● FA53601956-310 |
| Dali | Dali | Dali |
| ○ FA53612801-300 | ○ FA53602801-300 | ○ FA53602701-300 |
| ● FA53612056-300 | ● FA53602056-300 | ● FA53601956-300 |

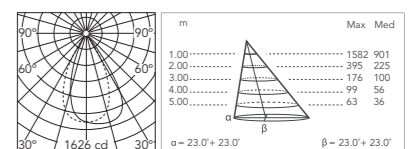

@ 4000K

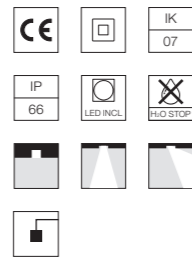
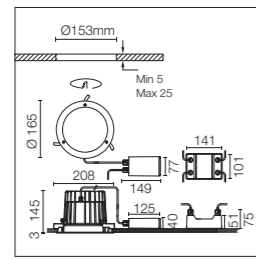

Sorgente a LED inclusa. Alimentazione elettrica 220-240V ON/OFF e dimmerabile 1-10V o DALI integrata: kit remoto dotato di spezzone di cavo 400mm con connettore a vite M12 a tenuta stagna all'apparecchio e di uno spezzone di cavo 250mm per il collegamento alla linea elettrica, da alloggiare in cassaforma da ordinare separatamente per soffitto in muratura, o da appoggiare in prossimità per controsoffitto in cartongesso.

LED source included. Integrated power supply 220-240V ON/OFF and dimmable 1-10V or DALI: remote kit with a 400mm cable section with watertight threaded M12 connector on the luminaire and a 250mm cable section for connection on the mains. This needs to be housed in the junction box for masonry ceilings (it needs to be ordered separately) or set next to the luminaire in case of plasterboard false ceilings. Dimmable version available upon request.

Optic Spot 20°

CoB Led: 30W - 3022 lm ≠ OUTPUT 2566 lm - 2700K/CRI 80 - 220÷240V / 30W - 3249 lm ≠ OUTPUT 2759 lm - 3000K/CRI 80 - 220÷240V / 30W - 3408 lm ≠ OUTPUT 2894 lm - 4000K/CRI 80 - 220÷240V

- | | | |
|------------------------------|------------------------------|------------------------------|
| 2700K
Non Dimmable | 3000K
Non Dimmable | 4000K
Non Dimmable |
| ○ FA53613801 | ○ FA53603801 | ○ FA53603701 |
| ● FA53613056 | ● FA53603056 | ● FA53602956 |
| 1-10V | 1-10V | 1-10V |
| ○ FA53613801-310 | ○ FA53603801-310 | ○ FA53603701-310 |
| ● FA53613056-310 | ● FA53603056-310 | ● FA53602956-310 |
| Dali | Dali | Dali |
| ○ FA53613801-300 | ○ FA53603801-300 | ○ FA53603701-300 |
| ● FA53613056-300 | ● FA53603056-300 | ● FA53602956-300 |

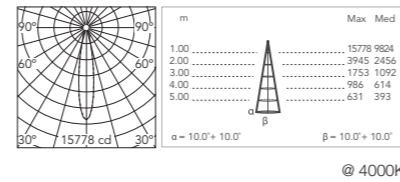

Optic Medium 40°

CoB Led: 30W - 3022 lm ≠ OUTPUT 2509 lm - 2700K/CRI 80 - 220÷240V / 30W - 3249 lm ≠ OUTPUT 2698 lm - 3000K/CRI 80 - 220÷240V / 30W - 3408 lm ≠ OUTPUT 2830 lm - 4000K/CRI 80 - 220÷240V

- | | | |
|------------------------------|------------------------------|------------------------------|
| 2700K
Non Dimmable | 3000K
Non Dimmable | 4000K
Non Dimmable |
| ○ FA53614001 | ○ FA53604001 | ○ FA53603901 |
| ● FA53613256 | ● FA53603256 | ● FA53603156 |
| 1-10V | 1-10V | 1-10V |
| ○ FA53614001-310 | ○ FA53604001-310 | ○ FA53603901-310 |
| ● FA53613256-310 | ● FA53603256-310 | ● FA53603156-310 |
| Dali | Dali | Dali |
| ○ FA53614001-300 | ○ FA53604001-300 | ○ FA53603901-300 |
| ● FA53613256-300 | ● FA53603256-300 | ● FA53603156-300 |

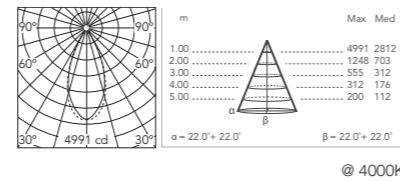

Asymmetric Optic 12° - 20°

CoB Led: 30W - 3022 lm ≠ OUTPUT 2096 lm - 2700K/CRI 80 - 220÷240V / 30W - 3249 lm ≠ OUTPUT 2254 lm - 3000K/CRI 80 - 220÷240V / 30W - 3408 lm ≠ OUTPUT 2364 lm - 4000K/CRI 80 - 220÷240V

- | | | |
|------------------------------|------------------------------|------------------------------|
| 2700K
Non Dimmable | 3000K
Non Dimmable | 4000K
Non Dimmable |
| ○ FA53614201 | ○ FA53604201 | ○ FA53604101 |
| ● FA53613456 | ● FA53603456 | ● FA53603356 |
| 1-10V | 1-10V | 1-10V |
| ○ FA53614201-310 | ○ FA53604201-310 | ○ FA53604101-310 |
| ● FA53613456-310 | ● FA53603456-310 | ● FA53603356-310 |
| Dali | Dali | Dali |
| ○ FA53614201-300 | ○ FA53604201-300 | ○ FA53604101-300 |
| ● FA53613456-300 | ● FA53603456-300 | ● FA53603356-300 |

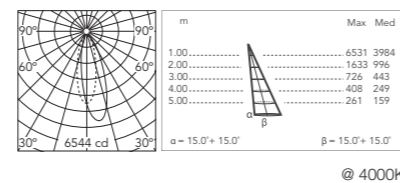

Asymmetric Optic 12° - 45°

CoB Led: 30W - 3022 lm ≠ OUTPUT 2007 lm - 2700K/CRI 80 - 220÷240V / 30W - 3249 lm ≠ OUTPUT 2158 lm - 3000K/CRI 80 - 220÷240V / 30W - 3408 lm ≠ OUTPUT 2263 lm - 4000K/CRI 80 - 220÷240V

- | | | |
|------------------------------|------------------------------|------------------------------|
| 2700K
Non Dimmable | 3000K
Non Dimmable | 4000K
Non Dimmable |
| ○ FA53614401 | ○ FA53604401 | ○ FA53604301 |
| ● FA53613656 | ● FA53603656 | ● FA53603556 |
| 1-10V | 1-10V | 1-10V |
| ○ FA53614401-310 | ○ FA53604401-310 | ○ FA53604301-310 |
| ● FA53613656-310 | ● FA53603656-310 | ● FA53603556-310 |
| Dali | Dali | Dali |
| ○ FA53614401-300 | ○ FA53604401-300 | ○ FA53604301-300 |
| ● FA53613656-300 | ● FA53603656-300 | ● FA53603556-300 |

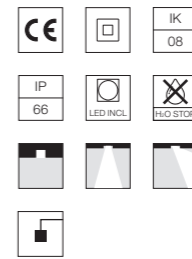
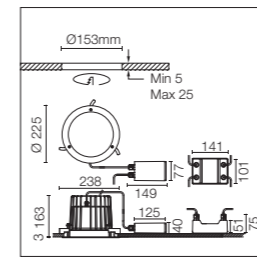
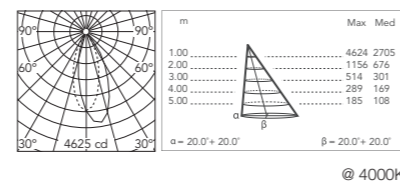

Sorgente a LED inclusa. Alimentazione elettrica 220-240V ON/OFF e dimmerabile 1-10V o DALI integrata: kit remoto dotato di spezzone di cavo 400mm con connettore a vite M12 a tenuta stagna all'apparecchio e di uno spezzone di cavo 250mm per il collegamento alla linea elettrica, da alloggiare in cassaforma da ordinare separatamente per soffitto in muratura, o da appoggiare in prossimità per controsoffitto in cartongesso.

LED source included. Integrated power supply 220-240V ON/OFF and dimmable 1-10V or DALI: remote kit with a 400mm cable section with watertight threaded M12 connector on the luminaire and a 250mm cable section for connection on the mains. This needs to be housed in the junction box for masonry ceilings (it needs to be ordered separately) or set next to the luminaire in case of plasterboard false ceilings. Dimmable version available upon request.

Optic Medium 45°

CoB Led: 43W - 4665 lm ≠ OUTPUT 3076 lm - 2700K/CRI 80 - 220÷240V / 43W - 5016 lm ≠ OUTPUT 3308 lm - 3000K/CRI 80 - 220÷240V / 43W - 5143 lm ≠ OUTPUT 3392 lm - 4000K/CRI 80 - 220÷240V

- | | | |
|------------------------------|------------------------------|------------------------------|
| 2700K
Non Dimmable | 3000K
Non Dimmable | 4000K
Non Dimmable |
| ○ FA53615601 | ○ FA53605601 | ○ FA53605501 |
| ● FA53614856 | ● FA53604856 | ● FA53604756 |
| 1-10V | 1-10V | 1-10V |
| ○ FA53615601-310 | ○ FA53605601-310 | ○ FA53605501-310 |
| ● FA53614856-310 | ● FA53604856-310 | ● FA53604756-310 |
| Dali | Dali | Dali |
| ○ FA53615601-300 | ○ FA53605601-300 | ○ FA53605501-300 |
| ● FA53614856-300 | ● FA53604856-300 | ● FA53604756-300 |

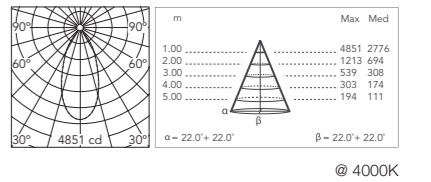

Asymmetric Optic 12° - 20°

CoB Led: 43W - 4665 lm ≠ OUTPUT 3028 lm - 2700K/CRI 80 - 220÷240V / 43W - 5016 lm ≠ OUTPUT 3256 lm - 3000K/CRI 80 - 220÷240V / 43W - 5143 lm ≠ OUTPUT 3338 lm - 4000K/CRI 80 - 220÷240V

- | | | |
|------------------------------|------------------------------|------------------------------|
| 2700K
Non Dimmable | 3000K
Non Dimmable | 4000K
Non Dimmable |
| ○ FA53615801 | ○ FA53605801 | ○ FA53605701 |
| ● FA53615056 | ● FA53605056 | ● FA53604956 |
| 1-10V | 1-10V | 1-10V |
| ○ FA53615801-310 | ○ FA53605801-310 | ○ FA53605701-310 |
| ● FA53615056-310 | ● FA53605056-310 | ● FA53604956-310 |
| Dali | Dali | Dali |
| ○ FA53615801-300 | ○ FA53605801-300 | ○ FA53605701-300 |
| ● FA53615056-300 | ● FA53605056-300 | ● FA53604956-300 |

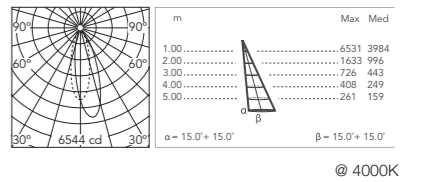







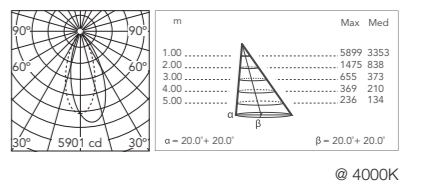



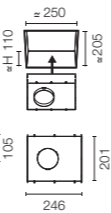

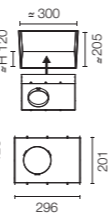
Asymmetric Optic 12° - 45°

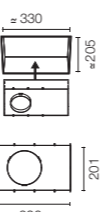
CoB Led: 43W - 4665 lm ≠ OUTPUT 2990 lm - 2700K/CRI 80 - 220÷240V / 43W - 5016 lm ≠ OUTPUT 3215 lm - 3000K/CRI 80 - 220÷240V / 43W - 5143 lm ≠ OUTPUT 3297 lm - 4000K/CRI 80 - 220÷240V

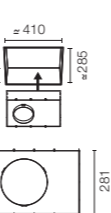
- | | | |
|------------------------------|------------------------------|------------------------------|
| 2700K
Non Dimmable | 3000K
Non Dimmable | 4000K
Non Dimmable |
| ○ FA53616001 | ○ FA53606001 | ○ FA53605901 |
| ● FA53615256 | ● FA53605256 | ● FA53605156 |
| 1-10V | 1-10V | 1-10V |
| ○ FA53616001-310 | ○ FA53606001-310 | ○ FA53605901-310 |
| ● FA53615256-310 | ● FA53605256-310 | ● FA53605156-310 |
| Dali | Dali | Dali |
| ○ FA53616001-300 | ○ FA53606001-300 | ○ FA53605901-300 |
| ● FA53615256-300 | ● FA53605256-300 | ● FA53605156-300 |

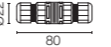

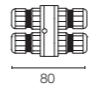
Leila: Accessori / Accessories

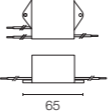
Scatola in metallo per installazione soffitti in cemento.	Metal installation box for concrete ceiling.	Leila 1 FA196		
Scatola in metallo per installazione soffitti in cemento.	Metal installation box for concrete ceiling.	Leila 2 FA197		
Scatola in metallo per installazione soffitti in cemento.	Metal installation box for concrete ceiling.	Leila 3 FA198		
Scatola in metallo per installazione soffitti in cemento.	Metal installation box for concrete ceiling.	Leila 4 FA199		
Sistema di giunzione IP68 H ₂ O Stop anti-condensa a 2 vie 4 poli. (ø5,5÷12mm cavo).	2 way terminal block 4 poles IP68 H ₂ O Stop. (ø5,5÷12mm cable).	F990C00A000		
Sistema di giunzione IP68 H ₂ O Stop anti-condensa a 3/4 vie 4 poli (ø5,5÷12mm cavo)	3/4 way terminal block 4 poles IP68 H ₂ O Stop. (ø5,5÷12mm cable).	F990C010000		
Dispositivo di protezione per il sovraccarico. 275Vac. Corrente massima di scarica 10KA (8/29µs). Massima corrente operativa 5A. Adatto per la connessione in serie. IP66.	Surge protection device. 275Vac. Maximum discharge current 10KA (8/20µs). Maximum operating current 5A. Suitable for series connection. IP66.	F990E00A000		

Kirk





Kirk



Famiglia / Family

Kirk 1



CoB Led
up to 6W
up to 244 lm - 3000K/CRI 80
* Net lumen output

Kirk 2



CoB Led
up to 12W
up to 713 lm - 3000K/CRI 80
* Net lumen output

Kirk 3



CoB Led
up to 24W
up to 1610 lm - 3000K/CRI 80
* Net lumen output

Descrizione / Description

Famiglia di apparecchi di illuminazione con sorgente luminosa a LED orientabili a proiezione, predisposti per installazione a soffitto, a parete e a terra con picchetto da ordinare separatamente. Disponibile in tre tagli dimensionali. Corpo in alluminio tornito lega EN AW 6060 e staffa di fissaggio in acciaio inox AISI 316L. Diffusore in vetro extrachiaro con bordo serigrafato, fissato attraverso un sistema di incollaggio robotizzato. Disponibile in differenti finiture con rivestimento a doppio strato di polveri e sottoposte a trattamento di conversione chimica superficiale per una elevata resistenza alla corrosione. L'unità di cablaggio è equipaggiata con connettore IP68 ed è collegata all'unità di emissione da una giunzione regolabile che permette una orientabilità di 130° circa sull'asse verticale. La staffa di fissaggio a sua volta permette una orientabilità di 90° sull'asse orizzontale per direzionare il fascio in base alle esigenze.

Family of tiltable projection luminaires with LED source, designed for ceiling, wall and ground mounting with a metal nail that needs to be ordered separately. Available in three dimensions. Turned aluminum body, EN AW6060 alloy and AISI 316L stainless steel bracket. Extraclear glass diffuser with silkscreen edge, attached with a robotic gluing system. Available in different finishes, with double-layered powder coating and chemical conversion surface treatment to ensure high corrosion resistance. The cable unit has a IP68 connector, connected to the emission unit by means of an adjustable joint so it can be tilted approx. 130° on the vertical axis. The fixing bracket allows for a tilting of 90° on the horizontal axis, so the light beam can be directed according to your needs.

Colori / Colours



01 White



06 Grey



12 Forest Green



18 Deep Brown



30 Black

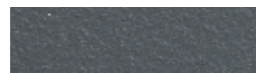

33 Anthracite

Kirk 1

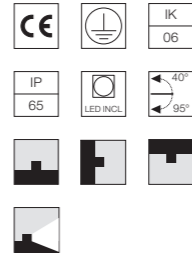
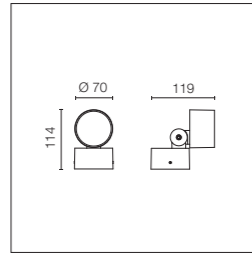

Sorgente a LED inclusa. Modulo Led configurato per lavorare direttamente alla rete elettrica 220-230V ON/ OFF. Staffa di fissaggio inclusa. Dotato di connettore IP68, per cavi in gomma 6mmϕ<math><8\text{mm}</math>. Per garantire la tenuta del passacavo è consigliabile utilizzare cavi elettrici flessibili idonei all'impiego in ambienti esterni. Picchetto per installazione a terra da ordinare separatamente.

LED source included. LED module configured to work directly on the mains 220-230V ON/OFF. Fixing bracket included. IP68 connector for 6mmϕ<math><8\text{mm}</math> rubber cable. To ensure the tightness of the cable guide it's recommended to use flexible electric cables suitable for exterior use. Ground spike to be ordered separately.

Optic Medium 50°

CoB Led: 6W - 350 lm \neq OUTPUT 244 lm - 3000K/CRI 80 - 220-230V

3000K

- FA54000101
- FA54000106
- FA54000112
- FA54000118
- FA54000130
- FA54000133

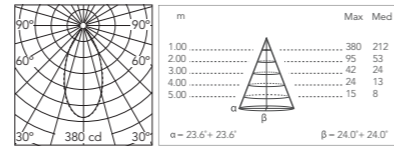

Kirk 2

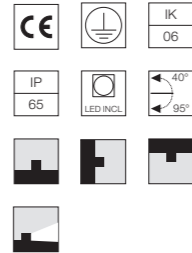
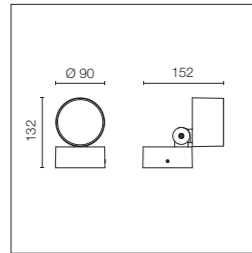

Sorgente a LED inclusa. Modulo Led configurato per lavorare direttamente alla rete elettrica 220-230V ON/ OFF. Staffa di fissaggio inclusa. Dotato di connettore IP68, per cavi in gomma 6mmϕ<math><8\text{mm}</math>. Per garantire la tenuta del passacavo è consigliabile utilizzare cavi elettrici flessibili idonei all'impiego in ambienti esterni. Picchetto per installazione a terra da ordinare separatamente.

LED source included. LED module configured to work directly on the mains 220-230V ON/OFF. Fixing bracket included. IP68 connector for 6mmϕ<math><8\text{mm}</math> rubber cable. To ensure the tightness of the cable guide it's recommended to use flexible electric cables suitable for exterior use. Ground spike to be ordered separately.

Optic Medium 30°

CoB Led: 12W - 951 lm \neq OUTPUT 713 lm - 3000K/CRI 80 - 220-230V

3000K

- FA54000201
- FA54000206
- FA54000212
- FA54000218
- FA54000230
- FA54000233

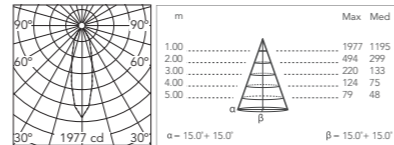

Kirk 3

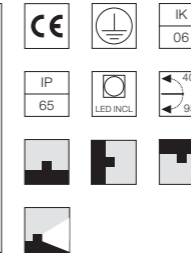
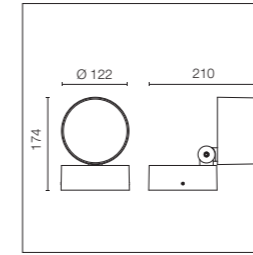

Sorgente a LED inclusa. Modulo Led configurato per lavorare direttamente alla rete elettrica 220-230V ON/ OFF. Staffa di fissaggio inclusa. Dotato di connettore IP68, per cavi in gomma 6mmϕ<math><8\text{mm}</math>. Per garantire la tenuta del passacavo è consigliabile utilizzare cavi elettrici flessibili idonei all'impiego in ambienti esterni. Picchetto per installazione a terra da ordinare separatamente.

LED source included. LED module configured to work directly on the mains 220-230V ON/OFF. Fixing bracket included. IP68 connector for 6mmϕ<math><8\text{mm}</math> rubber cable. To ensure the tightness of the cable guide it's recommended to use flexible electric cables suitable for exterior use. Ground spike to be ordered separately.

Optic Medium 40°

CoB Led: 24W - 2303 lm \neq OUTPUT 1610 lm - 3000K/CRI 80 - 220-230V

3000K

- FA54000301
- FA54000306
- FA54000312
- FA54000318
- FA54000330
- FA54000333

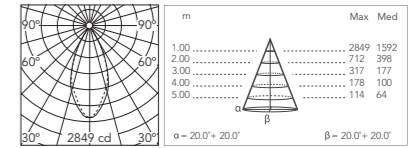

Kirk: Accessori / Accessories

Picchetto per installazione a terra.

Ground spike.

FA264

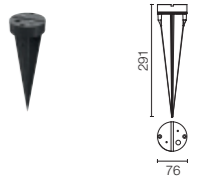

Picchetto per installazione a terra.

Ground spike.

FA266

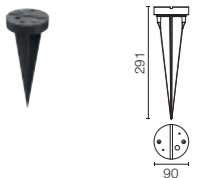

Picchetto per installazione a terra.

Ground spike.

FA268

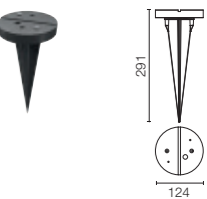

Dispositivo di protezione per il sovraccarico. 275Vac. Corrente massima di scarica 10KA (8/29 μ s). Massima corrente operativa 5A. Adatto per la connessione in serie. IP66.

Surge protection device. 275Vac. Maximum discharge current 10KA (8/20 μ s). Maximum operating current 5A. Suitable for series connection. IP66.

F990E00A000

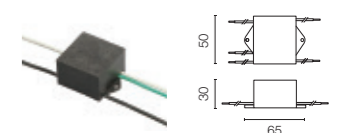

Spock

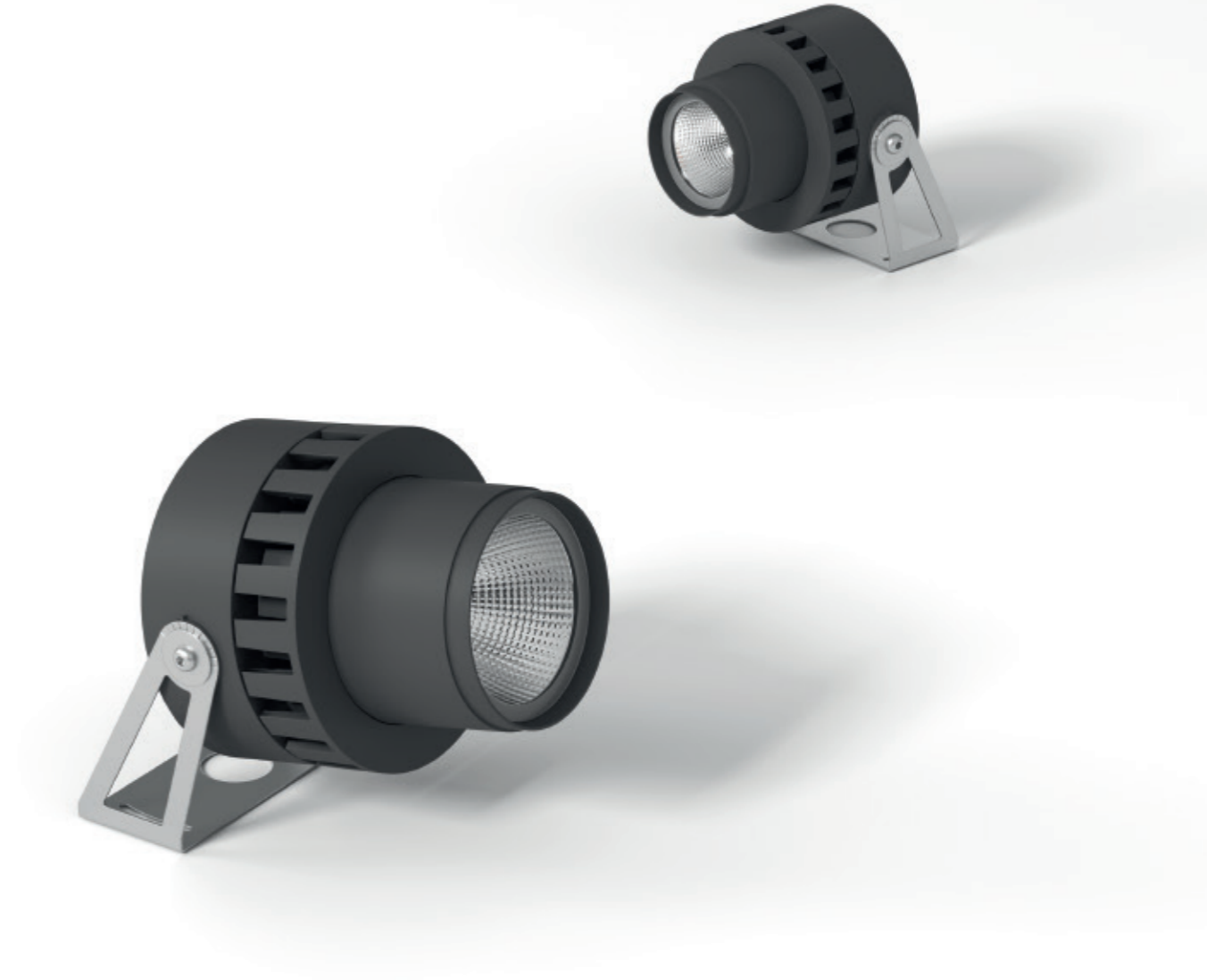



Spock



Famiglia / Family

Spock 1



CoB Led

up to 12W
up to 725 lm - 2700K/CRI 80
up to 780 lm - 3000K/CRI 80
up to 811 lm - 4000K/CRI 80

* Net lumen output

Spock 2



CoB Led

up to 29W
up to 2153 lm - 2700K/CRI 80
up to 2315 lm - 3000K/CRI 80
up to 2128 lm - 4000K/CRI 80

* Net lumen output

Spock 3



CoB Led

up to 52W
up to 4059 lm - 2700K/CRI 80
up to 4385 lm - 3000K/CRI 80
up to 4477 lm - 4000K/CRI 80

* Net lumen output

Tunable White

CoB Led

up to 38W
up to 2200 lm - 2700K/CRI 80

* Net lumen output

Descrizione / Description

Famiglia di apparecchi di illuminazione con sorgente luminosa a LED orientabili a proiezione, predisposti per installazione a soffitto, a parete e a terra con picchetto da ordinare separatamente. Disponibile in tre tagli dimensionali e in due aperture di fascio per dimensione. Corpo e dissipatore di calore in alluminio tornito lega EN AW 6060. Diffusore in vetro extrachiaro per le versioni standard e albarino per la versione Tunable White, con bordo serigrafato fissato attraverso un sistema di incollaggio robotizzato. Disponibile in differenti finiture con rivestimento a doppio strato di polveri e sottoposte a trattamento di conversione chimica superficiale per una elevata resistenza alla corrosione. Staffa di fissaggio in acciaio inox AISI 316L graduata per garantire una regolazione precisa della unità emittente e una orientabilità di 180° circa sull'asse verticale. La staffa di fissaggio a sua volta permette una orientabilità minima di 30° sull'asse orizzontale per direzionare il fascio in base alle esigenze. L'apparecchio è dotato di uno spezzone di cavo in uscita per una facile connessione. Completano la gamma una serie di visori ottici opzionali per calibrare il fascio luminoso emesso.

Family of tiltable projection luminaires with LED source, designed for ceiling, wall and ground mounting with a metal nail that needs to be ordered separately. Available in three dimensions and two beam angles per dimension. Body and heat sink made of turned aluminum, alloy EN AW 6060. Diffuser in extraclear glass for the standard version and in amber glass for the Tunable White version, with silkscreen edge and fixed with a robotic gluing system. Available in different finishes, with double-layered powder coating and chemical conversion surface treatment to ensure high corrosion resistance. AISI 316L stainless steel fixing bracket, graduated to guarantee precision in the adjustment of the emission unit and a tilting of approx. 180° in the vertical axis. The fixing bracket allows also for a tilting of 30° on the horizontal axis, so the light beam can be directed according to your needs. With a neoprene cable section to ease the connection. The series is completed with optional optical visors to graduate the emitted light beam.

Colori / Colours



01 White



06 Grey



12 Forest Green

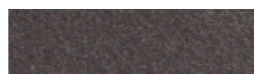

18 Deep Brown



30 Black

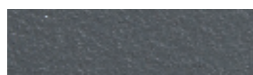

33 Anthracite

Spock 1

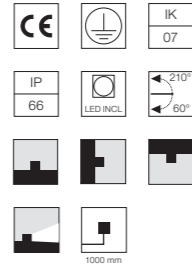
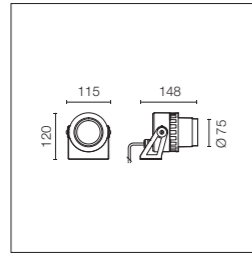

Sorgente a LED inclusa. Alimentazione elettrica 220-240V ON/OFF integrata. Staffa di fissaggio inclusa. Dotato di spezzone di cavo uscente in neoprene 1000 mm e kit con connettori crimp e guaina termorestringente adesiva per connessione a tenuta stagna; disponibili connettori IP68 opzionali. Picchetto per installazione a terra da ordinare separatamente. Accessori opzionali per la regolazione del fascio luminoso. Versione dimmerabile a richiesta.

LED source included. Integrated electrical power supply 220-240V ON/OFF. Fixing bracket included. Equipped with a 1000 mm protruding section of neoprene cable and a kit with crimpable connectors and adhesive heat-shrinkable sleeves that guarantee the tightness of the connection. Optional IP68 connectors available. The metal nail for ground installation needs to be ordered separately. Optional accessories to regulate the light beam. Dimmable version available upon request.

Optic Spot 20°

CoB Led: 12W - 1005 lm ≠ OUTPUT 725 lm - 2700K/CRI 80 - 220-240V / 12W - 1081 lm ≠ OUTPUT 780 lm - 3000K/CRI 80 - 220-240V / 12W - 1124 lm ≠ OUTPUT 811 lm - 4000K/CRI 80 - 220-240V

- | | | |
|--------------|--------------|--------------|
| 2700K | 3000K | 4000K |
| ○ FA54102301 | ○ FA54100301 | ○ FA54100201 |
| ● FA54102306 | ● FA54100306 | ● FA54100206 |
| ● FA54102312 | ● FA54100312 | ● FA54100212 |
| ● FA54102318 | ● FA54100318 | ● FA54100218 |
| ● FA54102330 | ● FA54100330 | ● FA54100230 |
| ● FA54102333 | ● FA54100333 | ● FA54100233 |

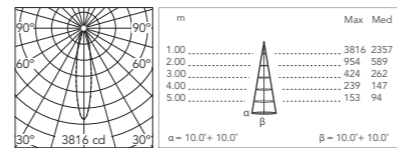

@ 4000K

Optic Medium 50°

CoB Led: 12W - 1005 lm ≠ OUTPUT 697 lm - 2700K/CRI 80 - 220-240V / 12W - 1081 lm ≠ OUTPUT 749 lm - 3000K/CRI 80 - 220-240V / 12W - 1124 lm ≠ OUTPUT 778 lm - 4000K/CRI 80 - 220-240V

- | | | |
|--------------|--------------|--------------|
| 2700K | 3000K | 4000K |
| ○ FA54102601 | ○ FA54100601 | ○ FA54100501 |
| ● FA54102606 | ● FA54100606 | ● FA54100506 |
| ● FA54102612 | ● FA54100612 | ● FA54100512 |
| ● FA54102618 | ● FA54100618 | ● FA54100518 |
| ● FA54102630 | ● FA54100630 | ● FA54100530 |
| ● FA54102633 | ● FA54100633 | ● FA54100533 |

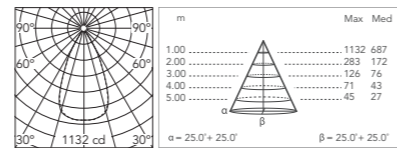

@ 4000K

Spock 2

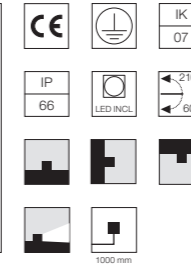
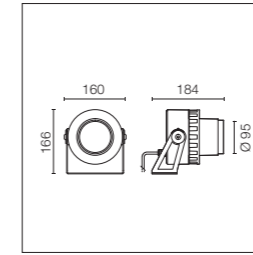

Sorgente a LED inclusa. Alimentazione elettrica 220-240V ON/OFF integrata. Staffa di fissaggio inclusa. Dotato di spezzone di cavo uscente in neoprene 1000 mm e kit con connettori crimp e guaina termorestringente adesiva per connessione a tenuta stagna; disponibili connettori IP68 opzionali. Picchetto per installazione a terra da ordinare separatamente. Accessori opzionali per la regolazione del fascio luminoso. Versione dimmerabile a richiesta.

LED source included. Integrated electrical power supply 220-240V ON/OFF. Fixing bracket included. Equipped with a 1000 mm protruding section of neoprene cable and a kit with crimpable connectors and adhesive heat-shrinkable sleeves that guarantee the tightness of the connection. Optional IP68 connectors available. The metal nail for ground installation needs to be ordered separately. Optional accessories to regulate the light beam. Dimmable version available upon request.

Optic Spot 20°

CoB Led: 29W - 3022 lm ≠ OUTPUT 2141 lm - 2700K/CRI 80 - 220-240V / 29W - 3249 lm ≠ OUTPUT 2302 lm - 3000K/CRI 80 - 220-240V / 29W - 3408 lm ≠ OUTPUT 2415 lm - 4000K/CRI 80 - 220-240V

- | | | |
|--------------|--------------|--------------|
| 2700K | 3000K | 4000K |
| ○ FA54102801 | ○ FA54100801 | ○ FA54100701 |
| ● FA54102806 | ● FA54100806 | ● FA54100706 |
| ● FA54102812 | ● FA54100812 | ● FA54100712 |
| ● FA54102818 | ● FA54100818 | ● FA54100718 |
| ● FA54102830 | ● FA54100830 | ● FA54100730 |
| ● FA54102833 | ● FA54100833 | ● FA54100733 |

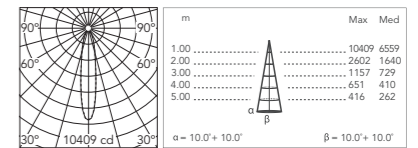

@ 4000K

Optic Medium 40°

CoB Led: 29W - 3022 lm ≠ OUTPUT 2153 lm - 2700K/CRI 80 - 220-240V / 29W - 3249 lm ≠ OUTPUT 2315 lm - 3000K/CRI 80 - 220-240V / 29W - 3408 lm ≠ OUTPUT 2428 lm - 4000K/CRI 80 - 220-240V

- | | | |
|--------------|--------------|--------------|
| 2700K | 3000K | 4000K |
| ○ FA54103001 | ○ FA54101001 | ○ FA54100901 |
| ● FA54103006 | ● FA54101006 | ● FA54100906 |
| ● FA54103012 | ● FA54101012 | ● FA54100912 |
| ● FA54103018 | ● FA54101018 | ● FA54100918 |
| ● FA54103030 | ● FA54101030 | ● FA54100930 |
| ● FA54103033 | ● FA54101033 | ● FA54100933 |

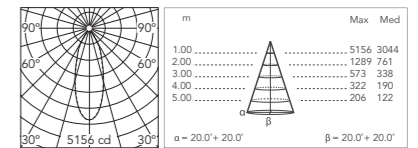

@ 4000K

Spock 3

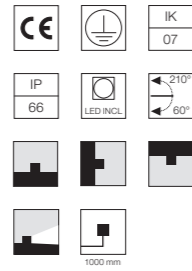
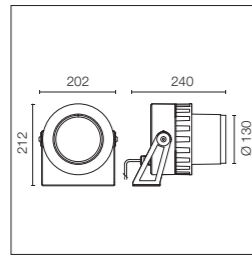

Sorgente a LED inclusa. Alimentazione elettrica 220-240V ON/OFF integrata. Staffa di fissaggio inclusa. Dotato di spezzone di cavo uscente in neoprene 1000 mm e kit con connettori crimp e guaina termorestringente adesiva per connessione a tenuta stagna; disponibili connettori IP68 opzionali. Picchetto per installazione a terra da ordinare separatamente. Accessori opzionali per la regolazione del fascio luminoso. Versione dimmerabile a richiesta.

LED source included. Integrated electrical power supply 220-240V ON/OFF. Fixing bracket included. Equipped with a 1000 mm protruding section of neoprene cable and a kit with crimpable connectors and adhesive heat-shrinkable sleeves that guarantee the tightness of the connection. Optional IP68 connectors available. The metal nail for ground installation needs to be ordered separately. Optional accessories to regulate the light beam. Dimmable version available upon request.

Optic Spot 20°

CoB Led: 52W - 5408 lm ≠ OUTPUT 4059 lm - 2700K/CRI 80 - 220-240V / 52W - 5815 lm ≠ OUTPUT 4365 lm - 3000K/CRI 80 - 220-240V / 52W - 5963 lm ≠ OUTPUT 4477 lm - 4000K/CRI 80 - 220-240V

2700K

- FA54103201
- FA54103206
- FA54103212
- FA54103218
- FA54103230
- FA54103233

3000K

- FA54101201
- FA54101206
- FA54101212
- FA54101218
- FA54101230
- FA54101233

4000K

- FA54101101
- FA54101106
- FA54101112
- FA54101118
- FA54101130
- FA54101133

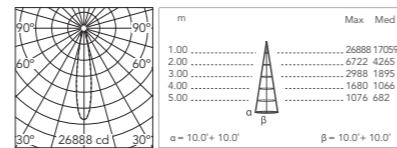

@ 4000K

Optic Medium 45°

CoB Led: 52W - 5408 lm ≠ OUTPUT 3981 lm - 2700K/CRI 80 - 220-240V / 52W - 5815 lm ≠ OUTPUT 4281 lm - 3000K/CRI 80 - 220-240V / 52W - 5963 lm ≠ OUTPUT 4390 lm - 4000K/CRI 80 - 220-240V

2700K

- FA54103401
- FA54103406
- FA54103412
- FA54103418
- FA54103430
- FA54103433

3000K

- FA54101401
- FA54101406
- FA54101412
- FA54101418
- FA54101430
- FA54101433

4000K

- FA54101301
- FA54101306
- FA54101312
- FA54101318
- FA54101330
- FA54101333

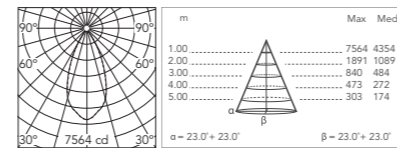

@ 4000K

Spock 3 Tunable White

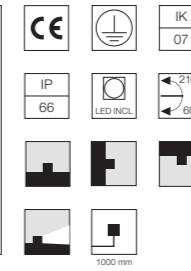
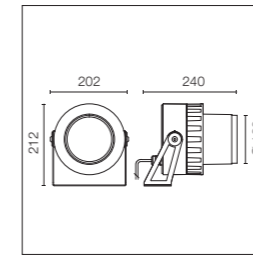

Sorgente a LED Tunable White inclusa. Alimentazione elettrica 120-240V DALI integrata. Staffa di fissaggio inclusa. Dotato di spezzone di cavo uscente in neoprene 1000 mm e kit con connettori crimp e guaina termorestringente adesiva per connessione a tenuta stagna; disponibili connettori IP68 opzionali. Picchetto per installazione a terra da ordinare separatamente. Accessori opzionali per la regolazione del fascio luminoso.

LED Tunable White source included. Integrated electrical power supply 120-240V DALI. Fixing bracket included. Equipped with a 1000 mm protruding section of neoprene cable and a kit with crimpable connectors and adhesive heat-shrinkable sleeves that guarantee the tightness of the connection. Optional IP68 connectors available. The metal nail for ground installation needs to be ordered separately. Optional accessories to regulate the light beam. Dimmable version available upon request.

Optic Spot 20°

CoB Led Tunable White: 38W - 2840 lm ≠ OUTPUT 2200 lm - 2700K ÷ 5700K/CRI>80 - 220-240V

2700K

- FA54110001
- FA54110006
- FA54110012
- FA54110018
- FA54110030
- FA54110033

Optic Medium 40°

CoB Led Tunable White: 38W - 2840 lm ≠ OUTPUT 2250 lm - 2700K ÷ 5700K/CRI>80 - 220-240V







2700K

- FA54110201
- FA54110206
- FA54110212
- FA54110218
- FA54110230
- FA54110233

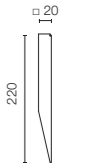
Spock: Accessori / Accessories

Visiera Ø75	Visor Ø75	FA20530		
Visiera Ø95	Visor Ø95	FA20630		
Visiera Ø130	Visor Ø130	FA20730		
Lente diffondente Ø75	Flood diffuser Ø75	FA20830		
Lente diffondente Ø95	Flood diffuser Ø95	FA20930		
Lente diffondente Ø130	Flood diffuser Ø130	FA21030		
Lente anti abbagliamento Ø75	Anti-glare louvre Ø75	FA21130		
Lente anti abbagliamento Ø95	Anti-glare louvre Ø95	FA21230		
Lente anti abbagliamento Ø130	Anti-glare louvre Ø130	FA21330		
Lente ellittica Ø75	Elliptical lens Ø75	FA26130		
Lente ellittica Ø95	Elliptical lens Ø95	FA26230		
Lente ellittica Ø130	Elliptical lens Ø130	FA26330		

Spock: Accessori / Accessories

Kit con 2 picchetti per fissaggio a terra.	Kit of 2 ground spikes.	FA203		
Sistema di giunzione IP68 H2O Stop anti-condensa a 3/4 vie 4 poli. (Ø5,5±12mm cavo).	3/4 way terminal block 4 poles IP68 H2O Stop. (ø5,5±12mm cable).	F990C010000		
Sistema di giunzione IP68 H2O Stop anti-condensa a 2 vie 4 poli. (Ø5,5±12mm cavo).	2 way terminal block 4 poles IP68 H2O Stop. (ø5,5±12mm cable).	F990C00A000		
Dispositivo di protezione per il sovraccarico. 275Vac. Corrente massima di scarica 10KA (8/29µs). Massima corrente operativa 5A. Adatto per la connessione in serie. IP66.	Surge protection device. 275Vac. Maximum discharge current 10KA (8/20µs). Maximum operating current 5A. Suitable for series connection. IP66.	F990E00A000		



Aimer



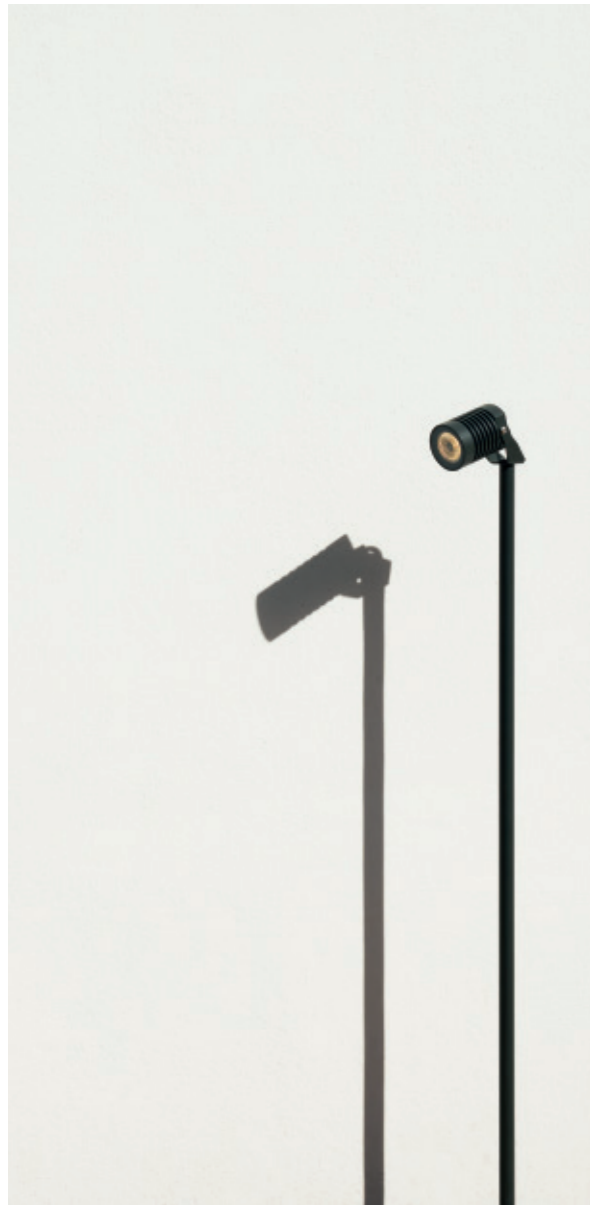

Aimer 2 Pole

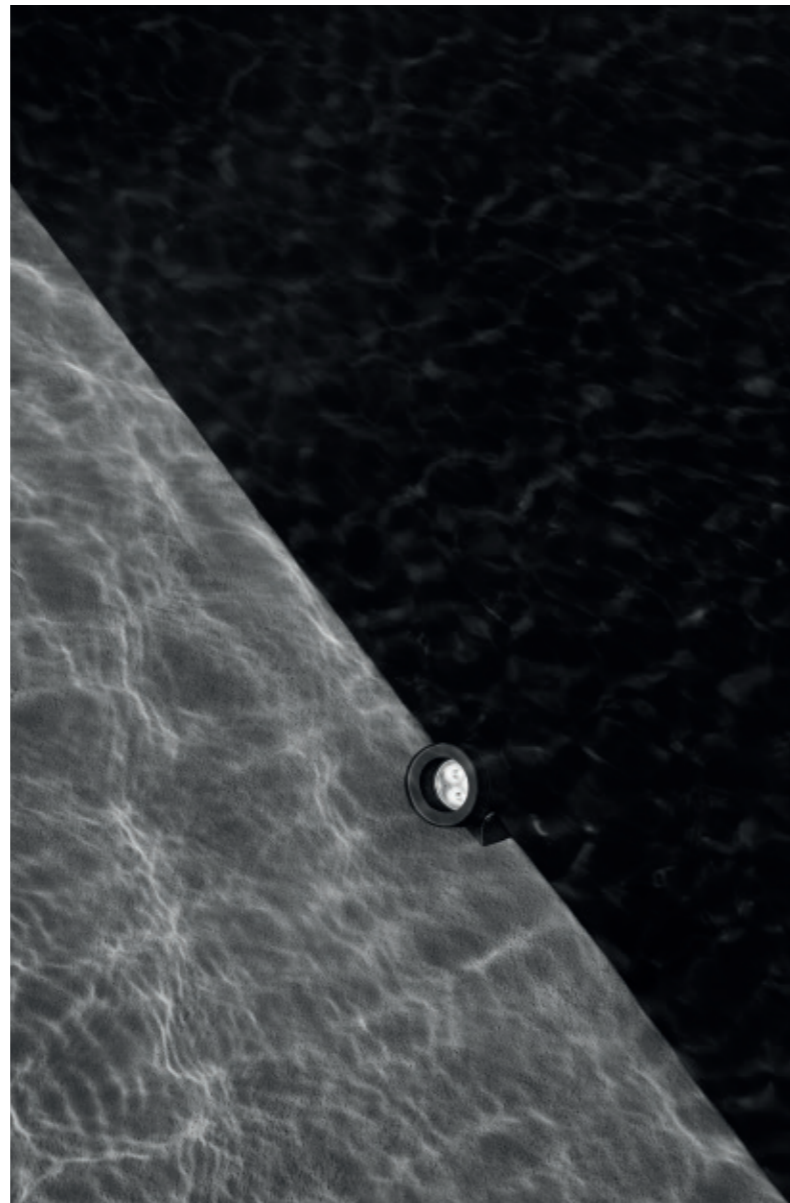

Aimer 1 Agua



Aimer 1

Famiglia / Family

Aimer 1



Power Led

up to 1,1W@350mA / 1,6W@500mA
up to 98@350mA lm / 111@500mA lm - 2700K/CRI 80
up to 106@350mA lm / 121@500mA lm - 3000K/CRI 80
up to 110@350mA lm / 125@500mA lm - 4000K/CRI 80
* Net lumen output

Aimer 1 RGB



Power Led

up to 3,4W
up to 3CH x 350mA
* Net lumen output

Famiglia / Family

Aimer 3



Power Led

up to 4,5W
up to 359 lm - 2700K/CRI 80
up to 395 lm - 3000K/CRI 80
up to 410 lm - 4000K/CRI 80
* Net lumen output

Power Led

up to 3,3W@350mA / 5,1W@500mA
up to 364@350mA lm / 364@500mA lm - 2700K/CRI 80
up to 297@350mA lm / 395@500mA lm - 3000K/CRI 80
up to 308@350mA lm / 410@500mA lm - 4000K/CRI 80
* Net lumen output

Aimer 3 RGB



Power Led

up to 3,4W
up to 3CH x 350mA
* Net lumen output

Aimer 2



Power Led

up to 3,4W
up to 138 lm - 2700K/CRI 80
up to 149 lm - 3000K/CRI 80
up to 155 lm - 4000K/CRI 80
* Net lumen output

Power Led

up to 4,5W
up to 246 lm - 2700K/CRI 80
up to 267 lm - 3000K/CRI 80
up to 277 lm - 4000K/CRI 80
* Net lumen output

Aimer 2 Pole



Power Led

up to 3,4W
up to 138 lm - 2700K/CRI 80
up to 149 lm - 3000K/CRI 80
up to 155 lm - 4000K/CRI 80
* Net lumen output

Aimer 2 Wall



Power Led

up to 3,4W
up to 138 lm - 2700K/CRI 80
up to 149 lm - 3000K/CRI 80
up to 155 lm - 4000K/CRI 80
* Net lumen output

Aimer 4



Power Led

up to 11,8W
up to 498 lm - 2700K/CRI 80
up to 535 lm - 3000K/CRI 80
up to 570 lm - 4000K/CRI 80
* Net lumen output

Aimer 5



Power Led

up to 17W
up to 747 lm - 2700K/CRI 80
up to 803 lm - 3000K/CRI 80
up to 855 lm - 4000K/CRI 80
* Net lumen output

Aimer 5 RGB



Power Led

up to 13,6W
up to 3CH x 350mA
* Net lumen output

Famiglia / Family

Aimer 1 Aqua



Power Led

up to 1,1W
up to 395 lm - 3000K/CRI 80
up to 410 lm - 4000K/CRI 80
* Net lumen output

Aimer 1 Aqua RGB



Power Led

up to 3,4W
up to 3CH x 350mA
* Net lumen output

Aimer 3 Aqua



Power Led

up to 4,5W
up to 267 lm - 3000K/CRI 80
up to 278 lm - 4000K/CRI 80
* Net lumen output

Aimer 3 Aqua RGB



Power Led

up to 3,4W
up to 3CH x 350mA
* Net lumen output

Aimer 4 Aqua



Power Led

up to 9W
up to 409 lm - 3000K/CRI 80
up to 435 lm - 4000K/CRI 80
* Net lumen output

Aimer 5 Aqua



Power Led

up to 14,7W
up to 680 lm - 3000K/CRI 80
up to 723 lm - 4000K/CRI 80
* Net lumen output

Aimer 5 Aqua RGB



Power Led

up to 13,6W
up to 3CH x 350mA
* Net lumen output

Descrizione / Description

Famiglia completa di apparecchi di illuminazione con sorgente luminosa a LED orientabili a proiezione, predisposti per installazione a soffitto, a parete e a terra. Caratterizzati dalla forma cilindrica compatta declinata in diverse dimensioni e da varie aperture di fascio per dimensione; completano la gamma le versioni RGB per la creazione di scenografie luminose colorate. Disponibili in differenti finiture con rivestimento a doppio strato di polveri e sottoposte a trattamento di conversione chimica superficiale per una elevata resistenza alla corrosione. Le viterie di fissaggio sono in acciaio inox AISI 316L.

Aimer

Apparecchi proiettori per installazione a soffitto, a parete e a terra con picchetto da ordinare separatamente. Disponibili in tre dimensioni di diametro con differenti fasci di apertura. Corpo dell'apparecchio in alluminio tornito (EN AW 6060) e anodizzato. Diffusore in vetro trasparente o sabbiato con bordo serigrafato, fissato attraverso un sistema di incollaggio robotizzato a filo con il bordo lampada per evitare depositi d'acqua. Staffa di fissaggio in acciaio inox AISI 316L inclusa. Dotati di uno spezzone di cavo in uscita per una facile connessione. Apparecchi disponibili in versione 24V dc (connessione in parallelo) o in versione 350/500 mA (connessione in serie): l'installazione necessita di alimentatore remoto da ordinare separatamente. Completano la gamma una serie di visori opzionali per ridurre l'abbagliamento diretto.

Aqua Aimer

Apparecchi proiettori per installazione a soffitto, a parete e a terra con picchetto da ordinare separatamente, adatti per l'immersione continua in acqua a 1 metro di profondità (grado di protezione IP68). Disponibili in tre dimensioni di diametro con differenti fasci di apertura. Corpo dell'apparecchio in acciaio inox AISI 316L. Diffusore in vetro trasparente o sabbiato con bordo serigrafato, fissato attraverso un sistema di incollaggio robotizzato a filo con il bordo lampada per evitare depositi d'acqua. Staffa di fissaggio in acciaio inox AISI 316L inclusa. Dotati di uno spezzone di cavo in uscita per una facile connessione. Apparecchi disponibili in versione 24V dc (connessione in parallelo) o in versione 350/500 mA (connessione in serie): l'installazione necessita di alimentatore remoto da ordinare separatamente.

Complete family of tiltable projection luminaires with LED source for wall, ceiling, and ground mounting. Defined by their compact cylinder shape. Available in different dimensions with different beam angles. Completed with the RGB versions to create sceneries with colored light. Available in different finishes, with double-layered powder coating and chemical conversion surface treatment to ensure high corrosion resistance. The fixing screws are made of stainless steel AISI 316L.

Aimer

Light projectors designed for ceiling, wall and ground mounting with a metal nail that needs to be ordered separately. Available in three different diameters and different beam angles. Turned (EN AW 6060) and anodized aluminum body. Transparent or frosted glass diffuser with silkscreen edge, attached flush to the edge with a robotic gluing system to avoid water deposits. AISI 316L Stainless steel bracket included. With a protruding cable section to ease the connection. Available in 24V dc version (parallel connection) or 350/500 mA version (serial connection). A remote power supply is needed and must be ordered separately. The series is completed with optional optical visors to reduce direct dazzling.

Aqua Aimer

Light projectors designed for ceiling, wall and ground mounting with a metal nail that needs to be ordered separately. Suitable for submersion to a depth of 1 meter (IP68 protection degree). Available in three different diameters and different beam angles. AISI 316L stainless steel body. Transparent or frosted glass diffuser with silkscreen edge, attached flush to the edge of the lamp with a robotic gluing system to avoid water deposits. AISI 316L Stainless steel bracket included. With a protruding cable section to ease the connection. Available in 24V version.

Colori / Colours



01 White



06 Grey



12 Forest Green

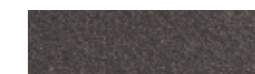

18 Deep Brown



30 Black

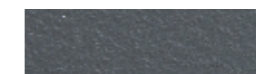

33 Anthracite



57 Polished Stainless Steel*



70 Anodized Aluminium

* Solo per versione Aimer Aqua. / Only for Aimer Aqua version.

Aimer 1 Constant Current

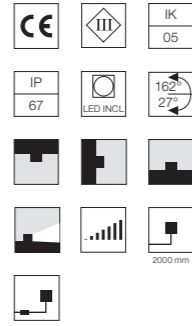
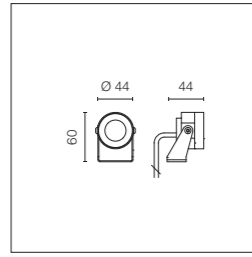

Sorgente a LED inclusa. Alimentazione elettrica remota 350/500 mA ON/OFF e dimmerabile 1-10V o DALI da ordinare separatamente. Connessione in serie. Dotato di spezzone di cavo uscente in neoprene di 2000 mm e kit con connettori crimp e guaina termorestringente adesiva per connessione a tenuta stagna. Staffa di fissaggio inclusa. Vetro trasparente extrachiaro. Picchetto per installazione a terra da ordinare separatamente.

LED source included. Remote power supply 350/500 mA ON/OFF and dimmable 1-10V or DALI. Must be ordered separately. Serial connection. Equipped with a 2000 mm protruding section of neoprene cable and a kit with crimpable connectors and adhesive heat-shrinkable sleeves that guarantee the tightness of the connection. Extraclear transparent glass. The metal nail for ground installation needs to be ordered separately.

Optic Spot 10°

Power Led: 1,1W@350mA - 110@350mA lm ≠ OUTPUT 98@350mA lm - 1,6W@500mA 144@500mA lm ≠ OUTPUT 111@500mA lm - 2700K/CRI 80
 1,1W@350mA - 120@350mA lm ≠ OUTPUT 106@350mA lm - 1,6W@500mA 155@500mA lm ≠ OUTPUT 121@500mA lm - 3000K/CRI 80
 1,1W@350mA - 124@350mA lm ≠ OUTPUT 110@350mA lm - 1,6W@500mA 161@500mA lm ≠ OUTPUT 125@500mA lm - 4000K/CRI 80

- | | | |
|----------------|----------------|----------------|
| 2700K | 3000K | 4000K |
| ○ FA1051442201 | ○ FA1051441201 | ○ FA1051711201 |
| ● FA1051442206 | ● FA1051441206 | ● FA1051711206 |
| ● FA1051442212 | ● FA1051441212 | ● FA1051711212 |
| ● FA1051442218 | ● FA1051441218 | ● FA1051711218 |
| ● FA1051442230 | ● FA1051441230 | ● FA1051711230 |
| ● FA1051442233 | ● FA1051441233 | ● FA1051711233 |
| ● FA1051442270 | ● FA1051441270 | ● FA1051711270 |

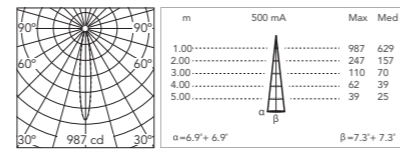
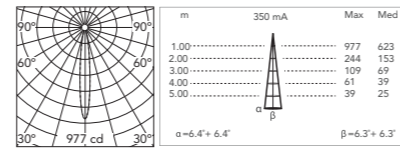

Optic Medium 30°

Power Led: 1,1W@350mA - 110@350mA lm ≠ OUTPUT 91@350mA lm - 1,6W@500mA 144@500mA lm ≠ OUTPUT 102@500mA lm - 2700K/CRI 80
 1,1W@350mA - 120@350mA lm ≠ OUTPUT 99@350mA lm - 1,6W@500mA 155@500mA lm ≠ OUTPUT 110@500mA lm - 3000K/CRI 80
 1,1W@350mA - 124@350mA lm ≠ OUTPUT 103@350mA lm - 1,6W@500mA 161@500mA lm ≠ OUTPUT 114@500mA lm - 4000K/CRI 80

- | | | |
|----------------|----------------|----------------|
| 2700K | 3000K | 4000K |
| ○ FA1051442001 | ○ FA1051440001 | ○ FA1051710001 |
| ● FA1051442006 | ● FA1051440006 | ● FA1051710006 |
| ● FA1051442012 | ● FA1051440012 | ● FA1051710012 |
| ● FA1051442018 | ● FA1051440018 | ● FA1051710018 |
| ● FA1051442030 | ● FA1051440030 | ● FA1051710030 |
| ● FA1051442033 | ● FA1051440033 | ● FA1051710033 |
| ● FA1051442070 | ● FA1051440070 | ● FA1051710070 |

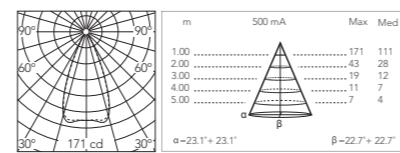
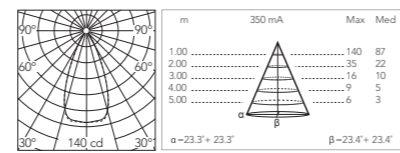

* Numero massimo di apparecchi per alimentatore / Maximum number of luminaires per power supply.

Numero massimo di apparecchi per alimentatore (Vin220÷240). Dati indicativi da verificare con le specifiche condizioni di installazione.	Maximum number of luminaires per power supply. (220÷240 V). These data must be checked taking into account the specific installation conditions.	Acc. RF25754 6	Acc. FA129 **16	**La tensione ai capi del sistema è in funzione del numero di apparecchi collegati in serie, attenersi alle norme CEI 64-8.	**The voltage at the end of the system depends on the number of fixtures connected in series, please comply with CEI 64-8 standards.
		Acc. RF25748 6	Acc. FA184 **16		
		Acc. FA68 10	Acc. FA135 **12		
			Acc. FA218 **12		
			Acc. FA238 **9		
			Acc. FA239 **9		

Aimer 1 RGB

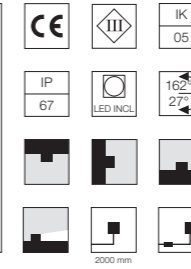
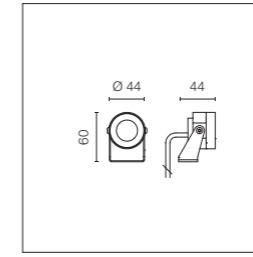

Sorgente RGB a LED inclusa. Alimentazione elettrica remota con interfaccia DMX 3chx350mA da ordinare separatamente. Connessione in serie. Dotato di spezzone di cavo uscente in neoprene di 2000 mm e kit con connettori crimp e guaina termorestringente adesiva per connessione a tenuta stagna. Staffa di fissaggio inclusa. Vetro sabbaiato. Picchetto per installazione a terra da ordinare separatamente.

RGB LED source included. Remote electrical power supply with DMX 3chx350mA interface to be ordered separately. Serial connection. Equipped with a 2000 mm protruding section of neoprene cable and a kit with crimpable connectors and adhesive heat-shrinkable sleeves that guarantee the tightness of the connection. Frosted glass. The metal nail for ground installation needs to be ordered separately.

Schema elettrico e installazione sistema RGB.

Massimo 10 apparecchi Aimer 1 RGB per ogni codice F990B22A000.

Vedere Schema Elettrico n.5 Pagina 670.

Wiring diagram and installation scheme RGB.

Max 10 luminaires Aimer 1 RGB for each code F990B22A000.

See Wiring Diagram n.5 Page 670.

RGB Power Led: 3, 4W - 3CH x 350mA

RGB

- FA1051730001
- FA1051730006
- FA1051730012
- FA1051730018
- FA1051730030
- FA1051730033
- FA1051730070

Photometric data on request.

* Numero massimo di apparecchi per alimentatore / Maximum number of luminaires per power supply.

Numero massimo di apparecchi per alimentatore (Vin220÷240). Dati indicativi da verificare con le specifiche condizioni di installazione.	Maximum number of luminaires per power supply. (220÷240 V). These data must be checked taking into account the specific installation conditions.	Acc. F990B22A000 **10	**La tensione ai capi del sistema è in funzione del numero di apparecchi collegati in serie, attenersi alle norme CEI 64-8.	**The voltage at the end of the system depends on the number of fixtures connected in series, please comply with CEI 64-8 standards.
--	--	-----------------------	---	--

Aimer 3 Constant Voltage

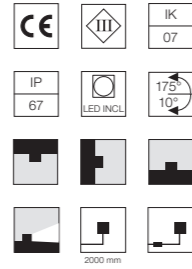
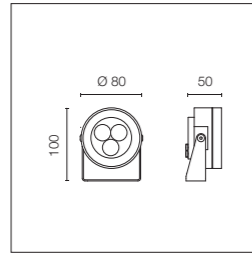

Sorgente a LED inclusa. Alimentazione elettrica remota 24 Vdc ON/OFF da ordinare separatamente. Connessione in parallelo. Dotato di spezzone di cavo uscente in neoprene di 2000 mm e kit con connettori crimp e guaina termorestringente adesiva per connessione a tenuta stagna. Staffa di fissaggio inclusa. Vetro trasparente extrachiario. Picchetto per installazione a terra da ordinare separatamente.

LED source included. Remote electrical power supply 24V dc ON/OFF to be ordered separately. Parallel connection. Equipped with a 2000 mm protruding section of neoprene cable and a kit with crimpable connectors and adhesive heat-shrinkable sleeves that guarantee the tightness of the connection. Fixing bracket included. Extraclear transparent glass. The metal nail for ground installation needs to be ordered separately.

Optic Spot 10°

Power Led: 4,5W - 431 lm ≠ OUTPUT 359 lm - 2700K/CRI 80 - 24Vdc / 4,5W - 466 lm ≠ OUTPUT 389 lm - 3000K/CRI 80 - 24Vdc / 4,5W - 484 lm ≠ OUTPUT 404 lm - 4000K/CRI 80 - 24Vdc

- | | | |
|---------------|---------------|----------------|
| 2700K | 3000K | 4000K |
| ○ FA105562201 | ○ FA105561201 | ○ FA1051721201 |
| ● FA105562206 | ● FA105561206 | ● FA1051721206 |
| ● FA105562212 | ● FA105561212 | ● FA1051721212 |
| ● FA105562218 | ● FA105561218 | ● FA1051721218 |
| ● FA105562230 | ● FA105561230 | ● FA1051721230 |
| ● FA105562233 | ● FA105561233 | ● FA1051721233 |
| ● FA105562270 | ● FA105561270 | ● FA1051721270 |

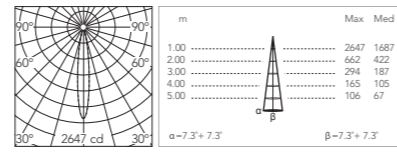

@ 3000K

Optic Medium 30°

Power Led: 4,5W - 431 lm ≠ OUTPUT 364 lm - 2700K/CRI 80 - 24Vdc / 4,5W - 466 lm ≠ OUTPUT 395 lm - 3000K/CRI 80 - 24Vdc / 4,5W - 484 lm ≠ OUTPUT 410 lm - 4000K/CRI 80 - 24Vdc

- | | | |
|---------------|---------------|----------------|
| 2700K | 3000K | 4000K |
| ○ FA105562101 | ○ FA105561101 | ○ FA1051721101 |
| ● FA105562106 | ● FA105561106 | ● FA1051721106 |
| ● FA105562112 | ● FA105561112 | ● FA1051721112 |
| ● FA105562118 | ● FA105561118 | ● FA1051721118 |
| ● FA105562130 | ● FA105561130 | ● FA1051721130 |
| ● FA105562133 | ● FA105561133 | ● FA1051721133 |
| ● FA105562170 | ● FA105561170 | ● FA1051721170 |

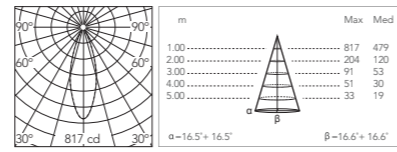

@ 3000K

Optic Flood 50°

Power Led: 4,5W - 431 lm ≠ OUTPUT 329 lm - 2700K/CRI 80 - 24Vdc / 4,5W - 466 lm ≠ OUTPUT 357 lm - 3000K/CRI 80 - 24Vdc / 4,5W - 484 lm ≠ OUTPUT 371 lm - 4000K/CRI 80 - 24Vdc

- | | | |
|---------------|---------------|----------------|
| 2700K | 3000K | 4000K |
| ○ FA105562001 | ○ FA105560001 | ○ FA1051720001 |
| ● FA105562006 | ● FA105560006 | ● FA1051720006 |
| ● FA105562012 | ● FA105560012 | ● FA1051720012 |
| ● FA105562018 | ● FA105560018 | ● FA1051720018 |
| ● FA105562030 | ● FA105560030 | ● FA1051720030 |
| ● FA105562033 | ● FA105560033 | ● FA1051720033 |
| ● FA105562070 | ● FA105560070 | ● FA1051720070 |

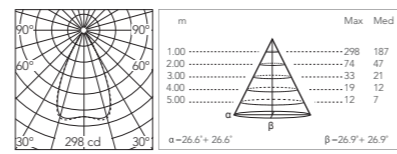

@ 3000K

* Numero massimo di apparecchi per alimentatore / Maximum number of luminaires per power supply.

Numero massimo di apparecchi per alimentatore (Vin220÷240). Dati indicativi da verificare con le specifiche condizioni di installazione.	Maximum number of luminaires per power supply. (220÷240 V). These data must be checked taking into account the specific installation conditions.	Acc. RF25754	1	Acc. RF25752	3
		Acc. RF25748	1	Acc. RF25755	7
		Acc. RF25747	2	Acc. RF25749	14
		Acc. RF25757	2		

Aimer 3 Constant Current

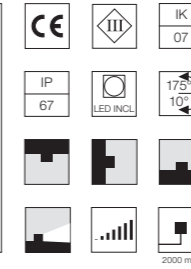
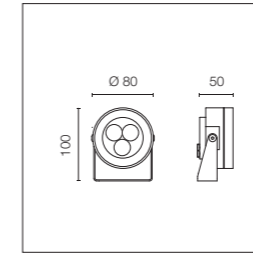

Sorgente a LED inclusa. Alimentazione elettrica remota 350/500 mA ON/OFF e dimmerabile 1-10V o DALI da ordinare separatamente. Connessione in serie. Dotato di spezzone di cavo uscente in neoprene di 2000 mm e kit con connettori crimp e guaina termorestringente adesiva per connessione a tenuta stagna. Staffa di fissaggio inclusa. Vetro trasparente extrachiario. Picchetto per installazione a terra da ordinare separatamente.

LED source included. Remote power supply 350/500 mA ON/OFF and dimmable 1-10V or DALI. Must be ordered separately. Serial connection. Equipped with a 2000 mm protruding section of neoprene cable and a kit with crimpable connectors and adhesive heat-shrinkable sleeves that guarantee the tightness of the connection. Extraclear transparent glass. The metal nail for ground installation needs to be ordered separately.

Optic Spot 10°

Power Led: 3,3W@350mA - 331@350mA lm ≠ OUTPUT 270@350mA lm / 5,1W@500mA - 431@500mA lm ≠ OUTPUT 359@500mA lm - 2700K/CRI 80 3,3W@350mA - 359@350mA lm ≠ OUTPUT 293@350mA lm - 5,1W@500mA - 466@500mA lm ≠ OUTPUT 389@500mA lm - 3000K/CRI 80 3,3W@350mA - 373@350mA lm ≠ OUTPUT 304@350mA lm - 5,1W@500mA - 484@500mA lm ≠ OUTPUT 404@500mA lm - 4000K/CRI 80

- | | | |
|----------------|----------------|----------------|
| 2700K | 3000K | 4000K |
| ○ FA1051072201 | ○ FA1051071201 | ○ FA1051901201 |
| ● FA1051072206 | ● FA1051071206 | ● FA1051901206 |
| ● FA1051072212 | ● FA1051071212 | ● FA1051901212 |
| ● FA1051072218 | ● FA1051071218 | ● FA1051901218 |
| ● FA1051072230 | ● FA1051071230 | ● FA1051901230 |
| ● FA1051072233 | ● FA1051071233 | ● FA1051901233 |
| ● FA1051072270 | ● FA1051071270 | ● FA1051901270 |

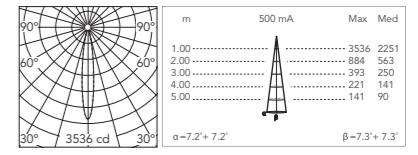

@ 3000K

Optic Medium 30°

Power Led: 3,3W@350mA - 331@350mA lm ≠ OUTPUT 274@350mA lm / 5,1W@500mA - 431@500mA lm ≠ OUTPUT 364@500mA lm - 2700K/CRI 80 3,3W@350mA - 359@350mA lm ≠ OUTPUT 297@350mA lm - 5,1W@500mA - 466@500mA lm ≠ OUTPUT 395@500mA lm - 3000K/CRI 80 3,3W@350mA - 373@350mA lm ≠ OUTPUT 308@350mA lm - 5,1W@500mA - 484@500mA lm ≠ OUTPUT 410@500mA lm - 4000K/CRI 80

- | | | |
|----------------|----------------|----------------|
| 2700K | 3000K | 4000K |
| ○ FA1051072101 | ○ FA1051071101 | ○ FA1051901101 |
| ● FA1051072106 | ● FA1051071106 | ● FA1051901106 |
| ● FA1051072112 | ● FA1051071112 | ● FA1051901112 |
| ● FA1051072118 | ● FA1051071118 | ● FA1051901118 |
| ● FA1051072130 | ● FA1051071130 | ● FA1051901130 |
| ● FA1051072133 | ● FA1051071133 | ● FA1051901133 |
| ● FA1051072170 | ● FA1051071170 | ● FA1051901170 |

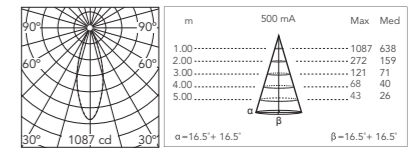

@ 3000K

Optic Flood 50°

Power Led: 3,3W@350mA - 331@350mA lm ≠ OUTPUT 247@350mA lm / 5,1W@500mA - 431@500mA lm ≠ OUTPUT 329@500mA lm - 2700K/CRI 80 3,3W@350mA - 359@350mA lm ≠ OUTPUT 267@350mA lm - 5,1W@500mA - 466@500mA lm ≠ OUTPUT 357@500mA lm - 3000K/CRI 80 3,3W@350mA - 373@350mA lm ≠ OUTPUT 278@350mA lm - 5,1W@500mA - 484@500mA lm ≠ OUTPUT 371@500mA lm - 4000K/CRI 80

- | | | |
|----------------|----------------|----------------|
| 2700K | 3000K | 4000K |
| ○ FA1051072001 | ○ FA1051070001 | ○ FA1051900001 |
| ● FA1051072006 | ● FA1051070006 | ● FA1051900006 |
| ● FA1051072012 | ● FA1051070012 | ● FA1051900012 |
| ● FA1051072018 | ● FA1051070018 | ● FA1051900018 |
| ● FA1051072030 | ● FA1051070030 | ● FA1051900030 |
| ● FA1051072033 | ● FA1051070033 | ● FA1051900033 |
| ● FA1051072070 | ● FA1051070070 | ● FA1051900070 |

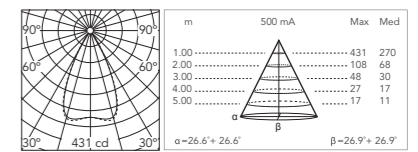

@ 3000K

* Numero massimo di apparecchi per alimentatore / Maximum number of luminaires per power supply.

Numero massimo di apparecchi per alimentatore (Vin220÷240). Dati indicativi da verificare con le specifiche condizioni di installazione.	Maximum number of luminaires per power supply. (220÷240 V). These data must be checked taking into account the specific installation conditions.	Acc. RF25754	2	Acc. FA135	**2	**La tensione ai capi del sistema è in funzione del numero di apparecchi collegati in serie, attenersi alle norme CEI 64-8.	**The voltage at the end of the system depends on the number of fixtures connected in series, please comply with CEI 64-8 standards.
		Acc. RF25748	2	Acc. FA218	**2		
		Acc. FA68	3	Acc. FA238	**3		
		Acc. FA129	**5	Acc. FA239	**3		
		Acc. FA184	**5				

Aimer 3 RGB

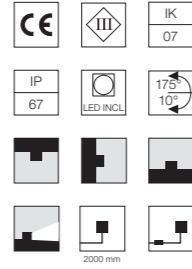
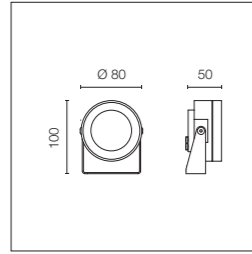

Sorgente RGB a LED inclusa. Alimentazione elettrica remota con interfaccia DMX 3chx350mA da ordinare separatamente. Connessione in serie. Dotato di spezzone di cavo uscente in neoprene di 2000 mm e kit con connettori crimp e guaina termorestringente adesiva per connessione a tenuta stagna. Staffa di fissaggio inclusa. Vetro sabbato. Picchetto per installazione a terra da ordinare separatamente.

Schema elettrico e installazione sistema RGB.

Massimo 10 apparecchi Aimer 3 RGB per ogni codice F990B22A000.

Vedere Schema Elettrico n.5 Pagina 670.

RGB LED source included. Remote electrical power supply with DMX 3chx350mA interface to be ordered separately. Serial connection. Equipped with a 2000 mm protruding section of neoprene cable and a kit with crimpable connectors and adhesive heat-shrinkable sleeves that guarantee the tightness of the connection. Frosted glass. The metal nail for ground installation needs to be ordered separately.

Wiring diagram and installation scheme RGB.

Max 10 luminaires Aimer 3 RGB for each code F990B22A000.

See Wiring Diagram n.5 Page 670.

Optic Spot 10°

Power Led: 3,4W - 3CH x 350mA

RGB

- FA1051741201
- FA1051741206
- FA1051741212
- FA1051741218
- FA1051741230
- FA1051741233
- FA1051741270

Optic Medium 35°

Power Led: 3,4W - 3CH x 350mA

RGB

- FA1051740001
- FA1051740006
- FA1051740012
- FA1051740018
- FA1051740030
- FA1051740033
- FA1051740070

Photometric data on request.

* Numero massimo di apparecchi per alimentatore / Maximum number of luminaires per power supply.

Numero massimo di apparecchi per alimentatore (Vin220+240). Dati indicativi da verificare con le specifiche condizioni di installazione.

Maximum number of luminaires per power supply. (220+240 V). These data must be checked taking into account the specific installation conditions.

Acc. F990B22A000 **10

**La tensione ai capi del sistema è in funzione del numero di apparecchi collegati in serie, attenersi alle norme CEI 64-8.

**The voltage at the end of the system depends on the number of fixtures connected in series, please comply with CEI 64-8 standards.

Aimer 4 Constant Voltage

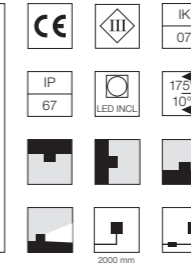
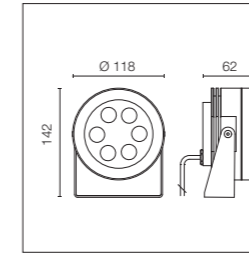

Sorgente a LED inclusa. Alimentazione elettrica remota 24 Vdc ON/OFF da ordinare separatamente. Connessione in parallelo. Dotato di spezzone di cavo uscente in neoprene di 2000 mm e kit con connettori crimp e guaina termorestringente adesiva per connessione a tenuta stagna. Staffa di fissaggio inclusa. Vetro trasparente extrachiario. Picchetto per installazione a terra da ordinare separatamente.

LED source included. Remote electrical power supply 24V dc ON/OFF to be ordered separately. Parallel connection. Equipped with a 2000 mm protruding section of neoprene cable and a kit with crimpable connectors and adhesive heat-shrinkable sleeves that guarantee the tightness of the connection. Fixing bracket included. Extraclear transparent glass. The metal nail for ground installation needs to be ordered separately.

Optic Spot 10°

Power Led: 11,8W - 776 lm ≠ OUTPUT 498 lm - 2700K/CRI 80 - 24Vdc / 11,8W - 834 lm ≠ OUTPUT 535 lm - 3000K/CRI 80 - 24Vdc / 11,8W - 889 lm ≠ OUTPUT 570 lm - 4000K/CRI 80 - 24Vdc

2700K

- FA1052552201
- FA1052552206
- FA1052552212
- FA1052552218
- FA1052552230
- FA1052552233
- FA1052552270

3000K

- FA1052551201
- FA1052551206
- FA1052551212
- FA1052551218
- FA1052551230
- FA1052551233
- FA1052551270

4000K

- FA1052541201
- FA1052541206
- FA1052541212
- FA1052541218
- FA1052541230
- FA1052541233
- FA1052541270

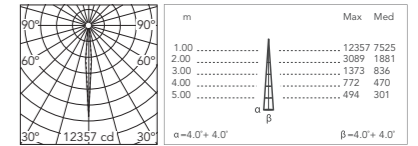

@ 4000K

Optic Medium 30°

Power Led: 11,8W - 776 lm ≠ OUTPUT 486 lm - 2700K/CRI 80 - 24Vdc / 11,8W - 834 lm ≠ OUTPUT 523 lm - 3000K/CRI 80 - 24Vdc / 11,8W - 889 lm ≠ OUTPUT 558 lm - 4000K/CRI 80 - 24Vdc

2700K

- FA1052552001
- FA1052552006
- FA1052552012
- FA1052552018
- FA1052552030
- FA1052552033
- FA1052552070

3000K

- FA1052550001
- FA1052550006
- FA1052550012
- FA1052550018
- FA1052550030
- FA1052550033
- FA1052550070

4000K

- FA1052540001
- FA1052540006
- FA1052540012
- FA1052540018
- FA1052540030
- FA1052540033
- FA1052540070

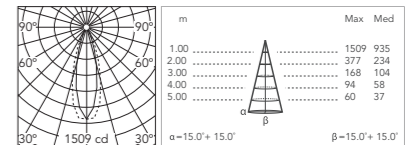

@ 4000K

* Numero massimo di apparecchi per alimentatore / Maximum number of luminaires per power supply.

Numero massimo di apparecchi per alimentatore (Vin220+240). Dati indicativi da verificare con le specifiche condizioni di installazione.

Maximum number of luminaires per power supply. (220+240 V). These data must be checked taking into account the specific installation conditions.

Acc. RF25752 1
Acc. RF25755 2
Acc. RF25749 5

Aimer 5 Constant Voltage

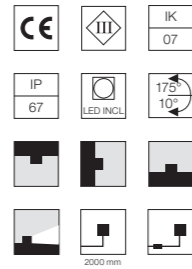
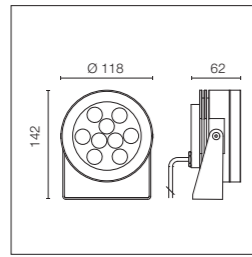

Sorgente a LED inclusa. Alimentazione elettrica remota 24 Vdc ON/OFF da ordinare separatamente. Connessione in parallelo. Dotato di spezzone di cavo uscente in neoprene di 2000 mm e kit con connettori crimp e guaina termorestringente adesiva per connessione a tenuta stagna. Staffa di fissaggio inclusa. Vetro trasparente extrachiario. Picchetto per installazione a terra da ordinare separatamente.

LED source included. Remote electrical power supply 24V dc ON/OFF to be ordered separately. Parallel connection. Equipped with a 2000 mm protruding section of neoprene cable and a kit with crimpable connectors and adhesive heat-shrinkable sleeves that guarantee the tightness of the connection. Fixing bracket included. Extraclear transparent glass. The metal nail for ground installation needs to be ordered separately.

Optic Spot 10°

Power Led: 17W - 1164 lm ≠ OUTPUT 747 lm - 2700K/CRI 80 - 24Vdc / 17W - 1252 lm ≠ OUTPUT 803 lm - 3000K/CRI 80 - 24Vdc / 17W - 1333 lm ≠ OUTPUT 855 lm - 4000K/CRI 80 - 24Vdc

- | | | |
|----------------|----------------|----------------|
| 2700K | 3000K | 4000K |
| ○ FA1052522201 | ○ FA1052521201 | ○ FA1052511201 |
| ● FA1052522206 | ● FA1052521206 | ● FA1052511206 |
| ● FA1052522212 | ● FA1052521212 | ● FA1052511212 |
| ● FA1052522218 | ● FA1052521218 | ● FA1052511218 |
| ● FA1052522230 | ● FA1052521230 | ● FA1052511230 |
| ● FA1052522233 | ● FA1052521233 | ● FA1052511233 |
| ● FA1052522270 | ● FA1052521270 | ● FA1052511270 |

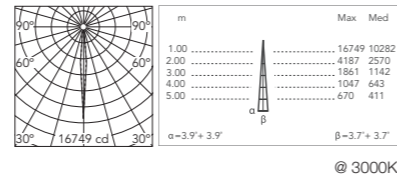

Optic Medium 30°

Power Led: 17W - 1164 lm ≠ OUTPUT 730 lm - 2700K/CRI 80 - 24Vdc / 17W - 1252 lm ≠ OUTPUT 785 lm - 3000K/CRI 80 - 24Vdc / 17W - 1333 lm ≠ OUTPUT 836 lm - 4000K/CRI 80 - 24Vdc

- | | | |
|----------------|----------------|----------------|
| 2700K | 3000K | 4000K |
| ○ FA1052522001 | ○ FA1052520001 | ○ FA1052510001 |
| ● FA1052522006 | ● FA1052520006 | ● FA1052510006 |
| ● FA1052522012 | ● FA1052520012 | ● FA1052510012 |
| ● FA1052522018 | ● FA1052520018 | ● FA1052510018 |
| ● FA1052522030 | ● FA1052520030 | ● FA1052510030 |
| ● FA1052522033 | ● FA1052520033 | ● FA1052510033 |
| ● FA1052522070 | ● FA1052520070 | ● FA1052510070 |

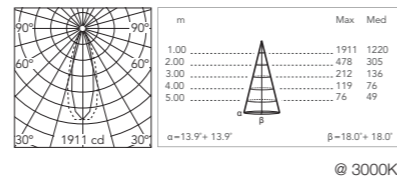

* Numero massimo di apparecchi per alimentatore / Maximum number of luminaires per power supply.

Numero massimo di apparecchi per alimentatore (Vin220±240). Dati indicativi da verificare con le specifiche condizioni di installazione.	Maximum number of luminaires per power supply. (220±240 V). These data must be checked taking into account the specific installation conditions.	Acc. RF25755	1
		Acc. RF25749	3

Aimer 5 RGB

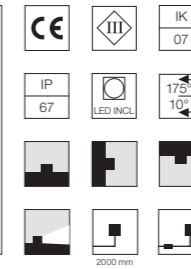
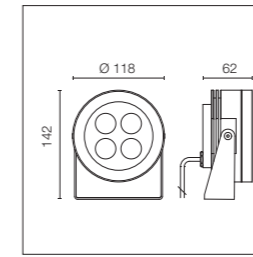

Sorgente RGB a LED inclusa. Alimentazione elettrica remota con interfaccia DMX 3chx350mA da ordinare separatamente. Connessione in serie. Dotato di spezzone di cavo uscente in neoprene di 2000 mm e kit con connettori crimp e guaina termorestringente adesiva per connessione a tenuta stagna. Staffa di fissaggio inclusa. Vetro sabbato. Picchetto per installazione a terra da ordinare separatamente.

RGB LED source included. Remote electrical power supply with DMX 3chx350mA interface to be ordered separately. Serial connection. Equipped with a 2000 mm protruding section of neoprene cable and a kit with crimpable connectors and adhesive heat-shrinkable sleeves that guarantee the tightness of the connection. Frosted glass. The metal nail for ground installation needs to be ordered separately.

Optic Spot 10°

RGB Power Led: 13,6W - 3CH x 350mA

- RGB**
- FA1052561201
 - FA1052561206
 - FA1052561212
 - FA1052561218
 - FA1052561230
 - FA1052561233
 - FA1052561270

Schema elettrico e installazione sistema RGB.

Massimo 2 apparecchi Aimer 5 RGB per ogni codice F990B22A000.

Vedere Schema Elettrico n.5 Pagina 670.

Wiring diagram and installation scheme RGB.

Max 2 luminaires Aimer 5 RGB for each code F990B22A000.

See Wiring Diagram n.5 Page 670.

Optic Medium 35°

RGB Power Led: 13,6W - 3CH x 350mA

- RGB**
- FA1052560001
 - FA1052560006
 - FA1052560012
 - FA1052560018
 - FA1052560030
 - FA1052560033
 - FA1052560070

Photometric data on request.





* Numero massimo di apparecchi per alimentatore / Maximum number of luminaires per power supply.

Numero massimo di apparecchi per alimentatore (Vin220±240). Dati indicativi da verificare con le specifiche condizioni di installazione.	Maximum number of luminaires per power supply. (220±240 V). These data must be checked taking into account the specific installation conditions.	Acc. F990B22A000	**2
--	--	------------------	-----

**La tensione ai capi del sistema è in funzione del numero di apparecchi collegati in serie, attenersi alle norme CEI 64-8.

**The voltage at the end of the system depends on the number of fixtures connected in series, please comply with CEI 64-8 standards.











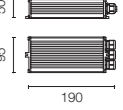

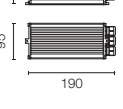

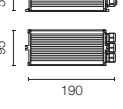

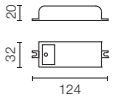
Aimer: Accessori / Accessories

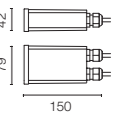
Visera Aimer 1.	Visor Aimer 1.	Aimer 1 FA5230		
Visera Aimer 3.	Visor Aimer 3.	Aimer 3 FA5130		
Picchetto per fissaggio a terra.	Ground spike.	Aimer 1 / 3 / 4 / 5 FA136		
Sistema di giunzione IP68 H2O Stop anti-condensa a 3/4 vie 4 poli. (Ø5,5÷12mm cavo).	3/4 way terminal block 4 poles IP68 H2O Stop. (Ø5,5÷12mm cable).	Aimer 3 / 4 / 5 F990C010000		
Sistema di giunzione IP68 H2O Stop anti-condensa a 2 vie 4 poli. (Ø5,5÷12mm cavo).	2 way terminal block 4 poles IP68 H2O Stop. (Ø5,5÷12mm cable).	Aimer 3 / 4 / 5 F990C00A000		

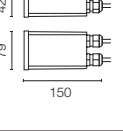

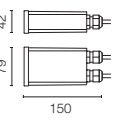

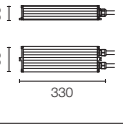

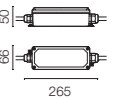



Aimer: Driver / Drivers

Alimentatore doppia funzione Vout 24Vdc: 8W/100÷240V Iout 350ma: 6x1W/100÷240V IP20 Classe II Selv Eq.	Power supply dual function Vout 24Vdc: 8W/100÷240V Iout 350ma: 6x1W/100÷240V IP20 Class II Selv Eq.	Aimer 1 / 3 *RF25754		
Alimentatore 24V 8W / 110-240V IP65 Classe II selv.	Power supply 24V 8W / 110-240V IP65 Class II selv.	Aimer 1 / 3 *RF25748		
Alimentatore 10 x 1W/ 100÷265V - Iout 350mA (7x1W/110V) IP40 Class II Selv Eq.	Power supply 10 x 1W/ 100÷265V - Iout 350mA (7x1W/110V) IP40 Class II Selv Eq.	Aimer 1 / 3 *FA68		
Alimentatore 16 x 1W/ 110÷240V - Iout 350mA (12x1W@110V) IP20 Class II Selv Eq.	Power supply 16 x 1W/ 110÷240V - Iout 350mA (12x1W@110V) IP20 Class II Selv Eq.	Aimer 1 / 3 *FA129 Dimmable Push-Dim Or 1-10V See Wiring Diagram n.3. Page 668		
Alimentatore 16 x 1W/ 110÷240V - Iout 350mA (12x1W@110V) IP67 Class II Selv.	Power supply 16 x 1W/ 110÷240V - Iout 350mA (12x1W@110V) IP67 Class II Selv.	Aimer 1 / 3 *FA184 Dimmable Push-Dim Or 1-10V See Wiring Diagram n.3. Page 668		
Alimentatore 13 x 2W/ 110÷240V - Iout 500mA (7x2W@110V) IP20 Class II Selv. Eq.	Power supply 13 x 2W/ 110÷240V - Iout 500mA (7x2W@110V) IP20 Class II Selv. Eq.	Aimer 1 / 3 *FA135 Dimmable DALI See Wiring Diagram n.3. Page 668		

Aimer: Driver / Drivers

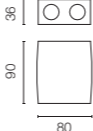
Alimentatore 13 x 2W/ 110÷240V - Iout 500mA (7x2W@110V) IP67 Class II Selv.	Power supply 13 x 2W/ 110÷240V - Iout 500mA (7x2W@110V) IP67 Class II Selv.	Aimer 1 / 3 *FA218 Dimmable Push-Dim Or 1-10V See Wiring Diagram n.3. Page 668		
Alimentatore 18W/ 110÷240V - Iout 350mA (15W@110V) IP67 Class II Selv. C	Power supply 18W/ 110÷240V - Iout 350mA (15W@110V) IP67 Class II Selv. C.	Aimer 1 / 3 *FA238 Dimmable DALI See Wiring Diagram n.3. Page 668		
Alimentatore 25W/ 110÷240V - Iout 350mA (15W@110V) IP67 Class II Selv.	Power supply 25W/ 110÷240V - Iout 350mA (15W@110V) IP67 Class II Selv.	Aimer 1 / 3 *FA239 Dimmable DALI See Wiring Diagram n.3. Page 668		
Alimentatore 24V 10W / 110-240V IP20 Classe II selv.	Power supply 24V 10W / 110-240V IP20 Class II selv.	Aimer 3 *RF25747		
Alimentatore 24V 10W / 110-240V IP67 Classe II selv.	Power supply 24V 10W / 110-240V IP67 Class II selv.	Aimer 3 *RF25757		
Alimentatore per installazione remota 24Vdc 20W / 220-240V IP67 Classe II selv.	Power supply for remote installation 24Vdc 20W / 220-240V IP67 Class II selv.	Aimer 3 / 4 / 5 *RF25752		
Alimentatore 24Vdc 35W / 120-270V IP67 Classe II selv.	Power supply 24Vdc 35W / 120-270V IP67 Class II selv.	F990B23AZ00		
Alimentatore per installazione remota 24Vdc 50W / 120-240V IP67 Classe II selv.	Power supply for remote installation 24Vdc 50W / 120-240V IP67 Class II selv.	Aimer 3 / 4 / 5 *RF25755		
Alimentatore per installazione remota 24Vdc 70W / 220-240V IP67 Classe II selv.	Power supply for remote installation 24Vdc 70W / 220-240V IP67 Class II selv.	Aimer 3 / 4 / 5 *RF25749		

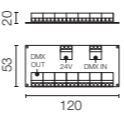
Aimer RGB: Accessori / Accessories

Visera Aimer 1.	Visor Aimer 1.	Aimer 1 RGB FA5230		
Visera Aimer 3.	Visor Martina.	Aimer 3 RGB FA5130		
Picchetto per installazione a terra.	Ground spike.	Aimer 1 / 3 / 4 / 5 RGB FA136		
Controller DMX a parete per scatole ad incasso (60mm interasse fori).	DMX controller; dimmer switch for recessed box (60mm hole centres).	F990B10A000		
Controller DMX stand-alone/interfaccia PC.	DMX controller; stand-alone/PC interface.	F990B11A000		
DMX splitter 512 - dispositivo elettronico per rigenerare segnale DMX monodirezionale 1 Input e 7 output, 12-24 Vdc.	DMX splitter 512 - electronic device to regenerate the monidirectional DMX signal 1 Input and 7 output, 12-24Vdc.	F990B13A000		
Cavo DMX schermato con impedenza costante 110 Ohm.	DMX cable - shielded twisted pair with 110 Ohm constant impedance.	F990B12A000		

Aimer 3 RGB: Driver / Drivers

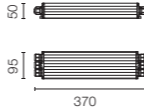
Alimentatore con interfaccia DMX per apparecchi RGB 36W/220÷240V-3CH x 350mA (3CH x 10 x 1W) predisposizione DMX IP67 Classe I Selv Eq.	Power supply with DMX interface for RGB fixtures 36W/220÷240V-3CH x 350mA (3CH x 10 x 1W) DMX control allowed IP67 Class I Selv Eq.	*F990B22A000		
---	---	--------------	---	---

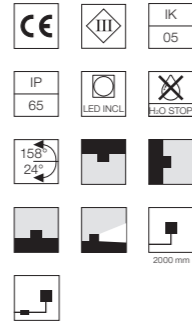
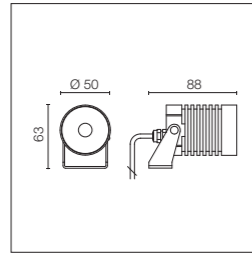

Sorgente a LED inclusa. Alimentazione elettrica remota 24V dc ON/OFF da ordinare separatamente. Dotato di spezzone di cavo uscente in neoprene di 2000 mm e kit con connettori crimp e guaina termorestringente adesiva per connessione a tenuta stagna. Staffa di fissaggio inclusa. Vetro trasparente extrachiario. Picchetto per installazione a terra da ordinare separatamente. Versione dimmerabile a richiesta.

LED source included. Remote electrical power supply 24V dc ON/OFF to be ordered separately. Equipped with a 2000 mm protruding section of neoprene cable and a kit with crimpable connectors and adhesive heat-shrinkable sleeves that guarantee the tightness of the connection. Fixing bracket included. Extraclear transparent glass. The metal nail for ground installation needs to be ordered separately. Dimmable version available upon request.

Optic Spot 10°

Power Led: 3,4W - 199 lm ≠ OUTPUT 138 lm - 2700K/CRI 80 - 24Vdc / 3,4W - 215 lm ≠ OUTPUT 149 lm - 3000K/CRI 80 - 24Vdc / 3,4W - 224 lm ≠ OUTPUT 155 lm - 4000K/CRI 80 - 24Vdc

- | | | |
|--------------|--------------|--------------|
| 2700K | 3000K | 4000K |
| ○ FA51308001 | ○ FA51300301 | ○ FA51300201 |
| ● FA51308006 | ● FA51300306 | ● FA51300206 |
| ● FA51308012 | ● FA51300312 | ● FA51300212 |
| ● FA51308018 | ● FA51300318 | ● FA51300218 |
| ● FA51308030 | ● FA51300330 | ● FA51300230 |
| ● FA51308033 | ● FA51300333 | ● FA51300233 |

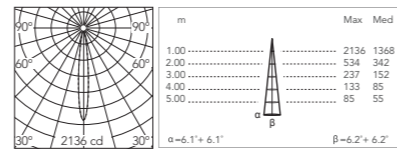

@3000K

Optic Medium 30°

Power Led: 3,4W - 199 lm ≠ OUTPUT 121 lm - 2700K/CRI 80 - 24Vdc / 3,4W - 215 lm ≠ OUTPUT 131 lm - 3000K/CRI 80 - 24Vdc / 3,4W - 224 lm ≠ OUTPUT 136 lm - 4000K/CRI 80 - 24Vdc

- | | | |
|--------------|--------------|--------------|
| 2700K | 3000K | 4000K |
| ○ FA51308201 | ○ FA51301301 | ○ FA51301201 |
| ● FA51308206 | ● FA51301306 | ● FA51301206 |
| ● FA51308212 | ● FA51301312 | ● FA51301212 |
| ● FA51308218 | ● FA51301318 | ● FA51301218 |
| ● FA51308230 | ● FA51301330 | ● FA51301230 |
| ● FA51308233 | ● FA51301333 | ● FA51301233 |

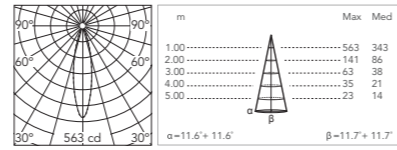

@3000K

* Numero massimo di apparecchi per alimentatore / Maximum number of luminaires per power supply.

Numero massimo di apparecchi per alimentatore (Vin220+240). Dati indicativi da verificare con le specifiche condizioni di installazione.	Maximum number of luminaires per power supply. (220+240 V). These data must be checked taking into account the specific installation conditions.	Acc. RF25754	1	Acc. RF25752	3
		Acc. RF25748	1	Acc. RF25755	9
		Acc. RF25747	2	Acc. RF25749	17
		Acc. RF25757	2		

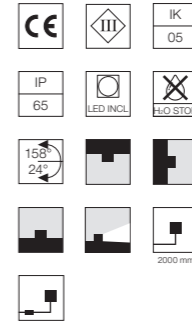
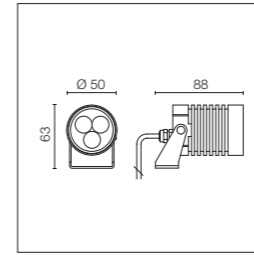

Sorgente a LED inclusa. Alimentazione elettrica remota 24V dc ON/OFF da ordinare separatamente. Dotato di spezzone di cavo uscente in neoprene di 2000 mm e kit con connettori crimp e guaina termorestringente adesiva per connessione a tenuta stagna. Staffa di fissaggio inclusa. Vetro trasparente extrachiario. Picchetto per installazione a terra da ordinare separatamente. Versione dimmerabile a richiesta.

LED source included. Remote electrical power supply 24V dc ON/OFF to be ordered separately. Equipped with a 2000 mm protruding section of neoprene cable and a kit with crimpable connectors and adhesive heat-shrinkable sleeves that guarantee the tightness of the connection. Fixing bracket included. Extraclear transparent glass. The metal nail for ground installation needs to be ordered separately. Dimmable version available upon request.

Optic Spot 10°

Power Led: 4,5W - 331 lm ≠ OUTPUT 246 lm - 2700K/CRI 80 - 24Vdc / 4,5W - 359 lm ≠ OUTPUT 267 lm - 3000K/CRI 80 - 24Vdc / 4,5W - 373 lm ≠ OUTPUT 277 lm - 4000K/CRI 80 - 24Vdc

- | | | |
|--------------|--------------|--------------|
| 2700K | 3000K | 4000K |
| ○ FA51308401 | ○ FA51302301 | ○ FA51302201 |
| ● FA51308406 | ● FA51302306 | ● FA51302206 |
| ● FA51308412 | ● FA51302312 | ● FA51302212 |
| ● FA51308418 | ● FA51302318 | ● FA51302218 |
| ● FA51308430 | ● FA51302330 | ● FA51302230 |
| ● FA51308433 | ● FA51302333 | ● FA51302233 |

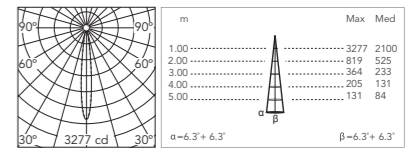

@3000K

Optic Medium 30°

Power Led: 4,5W - 331 lm ≠ OUTPUT 218 lm - 2700K/CRI 80 - 24Vdc / 4,5W - 359 lm ≠ OUTPUT 236 lm - 3000K/CRI 80 - 24Vdc / 4,5W - 373 lm ≠ OUTPUT 245 lm - 4000K/CRI 80 - 24Vdc

- | | | |
|--------------|--------------|--------------|
| 2700K | 3000K | 4000K |
| ○ FA51308601 | ○ FA51303301 | ○ FA51303201 |
| ● FA51308606 | ● FA51303306 | ● FA51303206 |
| ● FA51308612 | ● FA51303312 | ● FA51303212 |
| ● FA51308618 | ● FA51303318 | ● FA51303218 |
| ● FA51308630 | ● FA51303330 | ● FA51303230 |
| ● FA51308633 | ● FA51303333 | ● FA51303233 |

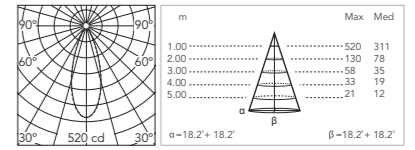

@3000K

* Numero massimo di apparecchi per alimentatore / Maximum number of luminaires per power supply.

Numero massimo di apparecchi per alimentatore (Vin220+240). Dati indicativi da verificare con le specifiche condizioni di installazione.	Maximum number of luminaires per power supply. (220+240 V). These data must be checked taking into account the specific installation conditions.	Acc. RF25754	1	Acc. RF25757	2
		Acc. RF25748	1	Acc. RF25755	9
		Acc. RF25747	2	Acc. RF25749	17

Aimer 2 Pole 500

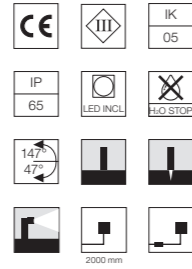
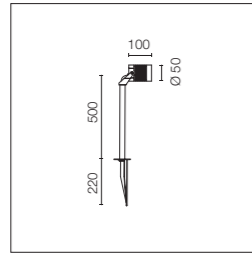

Sorgente a LED inclusa. Alimentazione elettrica remota 24V dc ON/OFF da ordinare separatamente. Dotato di spezzone di cavo uscente in neoprene di 2000 mm e morsettiera a 2 poli e 3 vie con sistema H2O STOP per connessione a tenuta stagna. Vetro trasparente extrachiario. Picchetto per installazione a terra incluso. Versione dimmerabile a richiesta.

LED source included. Remote electrical power supply 24V dc ON/OFF to be ordered separately. Equipped with a 2000 mm protruding section of neoprene cable and a 2-pole and 3-way connection box with H2O STOP system that guarantee the tightness of the connection. Extraclear transparent glass. Metal nail for ground installation included. Dimmable version available upon request.

Optic Spot 10°

Power Led: 3,4W - 199 lm ≠ OUTPUT 138 lm - 2700K/CRI 80 - 24Vdc / 3,4W - 215 lm ≠ OUTPUT 149 lm - 3000K/CRI 80 - 24Vdc / 3,4W - 224 lm ≠ OUTPUT 155 lm - 4000K/CRI 80 - 24Vdc

- | | | |
|--------------|--------------|--------------|
| 2700K | 3000K | 4000K |
| ○ FA51308801 | ○ FA51303601 | ○ FA51303501 |
| ● FA51308806 | ● FA51303606 | ● FA51303506 |
| ● FA51308812 | ● FA51303612 | ● FA51303512 |
| ● FA51308818 | ● FA51303618 | ● FA51303518 |
| ● FA51308830 | ● FA51303630 | ● FA51303530 |
| ● FA51308833 | ● FA51303633 | ● FA51303533 |

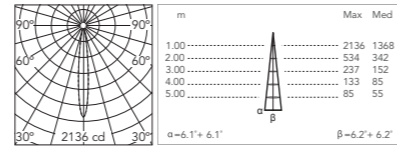

@3000K

Optic Medium 30°

Power Led: 3,4W - 199 lm ≠ OUTPUT 121 lm - 2700K/CRI 80 - 24Vdc / 3,4W - 215 lm ≠ OUTPUT 131 lm - 3000K/CRI 80 - 24Vdc / 3,4W - 224 lm ≠ OUTPUT 136 lm - 4000K/CRI 80 - 24Vdc

- | | | |
|--------------|--------------|--------------|
| 2700K | 3000K | 4000K |
| ○ FA51309001 | ○ FA51303901 | ○ FA51303801 |
| ● FA51309006 | ● FA51303906 | ● FA51303806 |
| ● FA51309012 | ● FA51303912 | ● FA51303812 |
| ● FA51309018 | ● FA51303918 | ● FA51303818 |
| ● FA51309030 | ● FA51303930 | ● FA51303830 |
| ● FA51309033 | ● FA51303933 | ● FA51303833 |

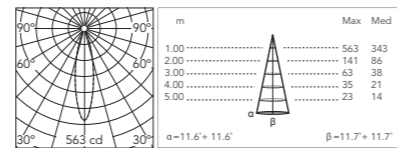

@3000K

* Numero massimo di apparecchi per alimentatore / Maximum number of luminaires per power supply.

Numero massimo di apparecchi per alimentatore (Vin220÷240). Dati indicativi da verificare con le specifiche condizioni di installazione.	Maximum number of luminaires per power supply. (220÷240 V). These data must be checked taking into account the specific installation conditions.	Acc. RF25754	1	Acc. RF25757	2
		Acc. RF25748	1	Acc. RF25752	3
		Acc. FA235	1	Acc. RF25755	9
		Acc. RF25747	2	Acc. RF25749	17

Aimer 2 Pole 900

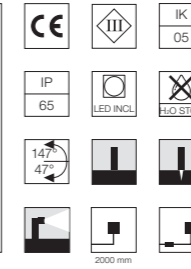
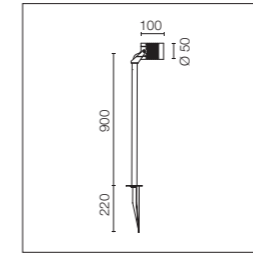

Sorgente a LED inclusa. Alimentazione elettrica remota 24V dc ON/OFF da ordinare separatamente. Dotato di spezzone di cavo uscente in neoprene di 2000 mm e morsettiera a 2 poli e 3 vie con sistema H2O STOP per connessione a tenuta stagna. Vetro trasparente extrachiario. Picchetto per installazione a terra incluso. Versione dimmerabile a richiesta.

LED source included. Remote electrical power supply 24V dc ON/OFF to be ordered separately. Equipped with a 2000 mm protruding section of neoprene cable and a 2-pole and 3-way connection box with H2O STOP system that guarantee the tightness of the connection. Extraclear transparent glass. Metal nail for ground installation included. Dimmable version available upon request.

Optic Spot 10°

Power Led: 3,4W - 199 lm ≠ OUTPUT 138 lm - 2700K/CRI 80 - 24Vdc / 3,4W - 215 lm ≠ OUTPUT 149 lm - 3000K/CRI 80 - 24Vdc / 3,4W - 224 lm ≠ OUTPUT 155 lm - 4000K/CRI 80 - 24Vdc

- | | | |
|--------------|--------------|--------------|
| 2700K | 3000K | 4000K |
| ○ FA51309201 | ○ FA51304801 | ○ FA51304701 |
| ● FA51309206 | ● FA51304806 | ● FA51304706 |
| ● FA51309212 | ● FA51304812 | ● FA51304712 |
| ● FA51309218 | ● FA51304818 | ● FA51304718 |
| ● FA51309230 | ● FA51304830 | ● FA51304730 |
| ● FA51309233 | ● FA51304833 | ● FA51304733 |

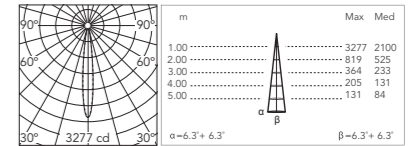

@3000K

Optic Medium 30°

Power Led: 3,4W - 199 lm ≠ OUTPUT 121 lm - 2700K/CRI 80 - 24Vdc / 3,4W - 215 lm ≠ OUTPUT 131 lm - 3000K/CRI 80 - 24Vdc / 3,4W - 224 lm ≠ OUTPUT 136 lm - 4000K/CRI 80 - 24Vdc

- | | | |
|--------------|--------------|--------------|
| 2700K | 3000K | 4000K |
| ○ FA51309401 | ○ FA51305101 | ○ FA51305001 |
| ● FA51309406 | ● FA51305106 | ● FA51305006 |
| ● FA51309412 | ● FA51305112 | ● FA51305012 |
| ● FA51309418 | ● FA51305118 | ● FA51305018 |
| ● FA51309430 | ● FA51305130 | ● FA51305030 |
| ● FA51309433 | ● FA51305133 | ● FA51305033 |

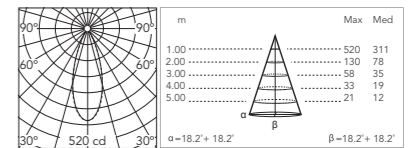

@3000K

* Numero massimo di apparecchi per alimentatore / Maximum number of luminaires per power supply.

Numero massimo di apparecchi per alimentatore (Vin220÷240). Dati indicativi da verificare con le specifiche condizioni di installazione.	Maximum number of luminaires per power supply. (220÷240 V). These data must be checked taking into account the specific installation conditions.	Acc. RF25754	1	Acc. RF25757	2
		Acc. RF25748	1	Acc. RF25752	3
		Acc. FA235	1	Acc. RF25755	9
		Acc. RF25747	2	Acc. RF25749	17

Aimer 2 Wall 500

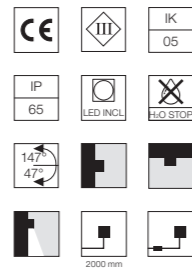
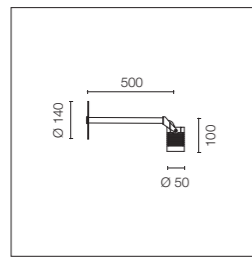

Sorgente a LED inclusa. Alimentazione elettrica remota 24V dc ON/OFF da ordinare separatamente. Dotato di spezzone di cavo uscente in neoprene di 2000 mm e morsettiera a 2 poli e 3 vie con sistema H2O STOP per connessione a tenuta stagna. Vetro trasparente extrachiaro. Picchetto per installazione a terra incluso. Versione dimmerabile a richiesta.

LED source included. Remote electrical power supply 24V dc ON/OFF to be ordered separately. Equipped with a 2000 mm protruding section of neoprene cable and a 2-pole and 3-way connection box with H2O STOP system that guarantee the tightness of the connection. Extraclear transparent glass. Metal nail for ground installation included. Dimmable version available upon request.

Optic Spot 10°

Power Led: 3,4W - 199 lm ≠ OUTPUT 138 lm - 2700K/CRI 80 - 24Vdc / 3,4W - 215 lm ≠ OUTPUT 149 lm - 3000K/CRI 80 - 24Vdc / 3,4W - 224 lm ≠ OUTPUT 155 lm - 4000K/CRI 80 - 24Vdc

- | | | |
|--------------|--------------|--------------|
| 2700K | 3000K | 4000K |
| ○ FA51309601 | ○ FA51306001 | ○ FA51305901 |
| ● FA51309606 | ● FA51306006 | ● FA51305906 |
| ● FA51309612 | ● FA51306012 | ● FA51305912 |
| ● FA51309618 | ● FA51306018 | ● FA51305918 |
| ● FA51309630 | ● FA51306030 | ● FA51305930 |
| ● FA51309633 | ● FA51306033 | ● FA51305933 |

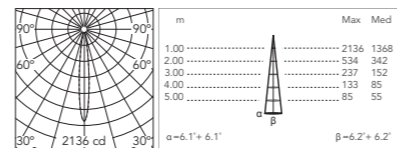

@3000K

Optic Medium 30°

Power Led: 3,4W - 199 lm ≠ OUTPUT 121 lm - 2700K/CRI 80 - 24Vdc / 3,4W - 215 lm ≠ OUTPUT 131 lm - 3000K/CRI 80 - 24Vdc / 3,4W - 224 lm ≠ OUTPUT 136 lm - 4000K/CRI 80 - 24Vdc

- | | | |
|--------------|--------------|--------------|
| 2700K | 3000K | 4000K |
| ○ FA51309801 | ○ FA51306301 | ○ FA51306201 |
| ● FA51309806 | ● FA51306306 | ● FA51306206 |
| ● FA51309812 | ● FA51306312 | ● FA51306212 |
| ● FA51309818 | ● FA51306318 | ● FA51306218 |
| ● FA51309830 | ● FA51306330 | ● FA51306230 |
| ● FA51309833 | ● FA51306333 | ● FA51306233 |

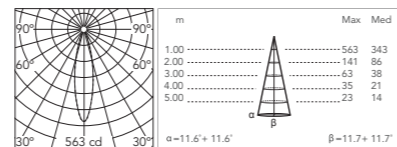

@3000K

* Numero massimo di apparecchi per alimentatore / Maximum number of luminaires per power supply.

Numero massimo di apparecchi per alimentatore (Vin220+240). Dati indicativi da verificare con le specifiche condizioni di installazione.	Maximum number of luminaires per power supply. (220+240 V). These data must be checked taking into account the specific installation conditions.	Acc. RF25754	1	Acc. RF25755	9
		Acc. RF25748	1	Acc. RF25749	17
		Acc. RF25752	3		

Aimer 2 Wall 900

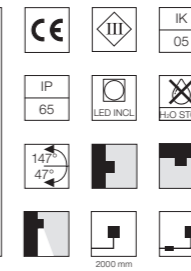
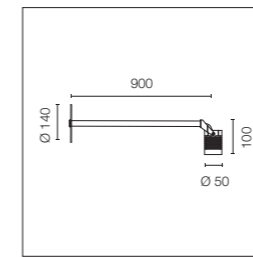

Sorgente a LED inclusa. Alimentazione elettrica remota 24V dc ON/OFF da ordinare separatamente. Dotato di spezzone di cavo uscente in neoprene di 2000 mm e morsettiera a 2 poli e 3 vie con sistema H2O STOP per connessione a tenuta stagna. Vetro trasparente extrachiaro. Picchetto per installazione a terra incluso. Versione dimmerabile a richiesta.

LED source included. Remote electrical power supply 24V dc ON/OFF to be ordered separately. Equipped with a 2000 mm protruding section of neoprene cable and a 2-pole and 3-way connection box with H2O STOP system that guarantee the tightness of the connection. Extraclear transparent glass. Metal nail for ground installation included. Dimmable version available upon request.

Optic Spot 10°

Power Led: 3,4W - 199 lm ≠ OUTPUT 138 lm - 2700K/CRI 80 - 24Vdc / 3,4W - 215 lm ≠ OUTPUT 149 lm - 3000K/CRI 80 - 24Vdc / 3,4W - 224 lm ≠ OUTPUT 155 lm - 4000K/CRI 80 - 24Vdc

- | | | |
|--------------|--------------|--------------|
| 2700K | 3000K | 4000K |
| ○ FA51310001 | ○ FA51306601 | ○ FA51306501 |
| ● FA51310006 | ● FA51306606 | ● FA51306506 |
| ● FA51310012 | ● FA51306612 | ● FA51306512 |
| ● FA51310018 | ● FA51306618 | ● FA51306518 |
| ● FA51310030 | ● FA51306630 | ● FA51306530 |
| ● FA51310033 | ● FA51306633 | ● FA51306533 |

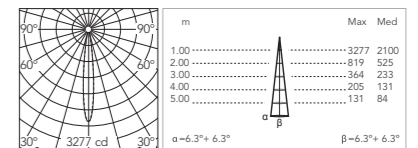

@3000K

Optic Medium 30°

Power Led: 3,4W - 199 lm ≠ OUTPUT 121 lm - 2700K/CRI 80 - 24Vdc / 3,4W - 215 lm ≠ OUTPUT 131 lm - 3000K/CRI 80 - 24Vdc / 3,4W - 224 lm ≠ OUTPUT 136 lm - 4000K/CRI 80 - 24Vdc

- | | | |
|--------------|--------------|--------------|
| 2700K | 3000K | 4000K |
| ○ FA51310201 | ○ FA51306901 | ○ FA51306801 |
| ● FA51310206 | ● FA51306906 | ● FA51306806 |
| ● FA51310212 | ● FA51306912 | ● FA51306812 |
| ● FA51310218 | ● FA51306918 | ● FA51306818 |
| ● FA51310230 | ● FA51306930 | ● FA51306830 |
| ● FA51310233 | ● FA51306933 | ● FA51306833 |

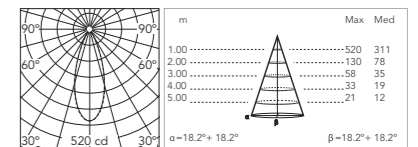





@3000K

* Numero massimo di apparecchi per alimentatore / Maximum number of luminaires per power supply.

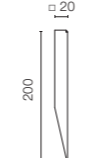
Numero massimo di apparecchi per alimentatore (Vin220+240). Dati indicativi da verificare con le specifiche condizioni di installazione.	Maximum number of luminaires per power supply. (220+240 V). These data must be checked taking into account the specific installation conditions.	Acc. RF25754	1	Acc. RF25755	9
		Acc. RF25748	1	Acc. RF25749	17
		Acc. RF25752	3		

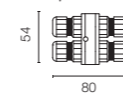
Aimer 2: Accessori / Accessories

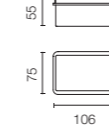
Picchetto per installazione a terra.	Ground spike.	Spot / Pole FA136		
Sistema di giunzione IP68 H2O Stop anti-condensa a 3/4 vie 4 poli. (Ø5,5÷12mm cavo).	3/4 way terminal block 4 poles IP68 H2O Stop. (ø5,5÷12mm cable).	Pole F990C010000		
Scatola di derivazione da incasso 3 moduli (modello 503)	Recessed 3-module junction box (model 503)	Wall F990H010000		

Aimer 2 Wall Bracket with box cod. F990H010000

Opzionale: alimentatore art. F990H010000 in scatola da incasso.
Optional: power supply code F990H010000 in recessed box.

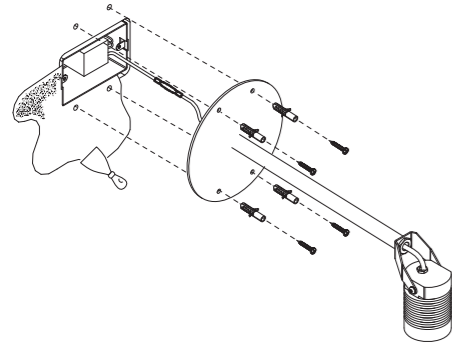

Aimer 2: Driver/ Drivers

Alimentatore doppia funzione Vout 24Vdc: 8W/100÷240V Iout 350ma: 6x1W/100÷240V IP20 Classe II Selv Eq.	Power supply dual function Vout 24Vdc: 8W/100÷240V Iout 350ma: 6x1W/100÷240V IP20 Class II Selv Eq.	*RF25754		
Alimentatore 24V 8W / 110-240V IP65 Classe II selv.	Power supply 24V 8W / 110-240V IP65 Class II selv.	*RF25748		
Alimentatore 8W/110÷240V - 24Vdc IP67 Classe II Selv Eq.	Power supply 8W/110÷240V - 24Vdc IP67 Class II selv. Eq.	Pole *FA235		
Alimentatore 24V 10W / 110-240V IP20 Classe II selv.	Power supply 24V 10W / 110-240V IP20 Class II selv.	Spot / Pole *RF25747		
Alimentatore 24V 10W / 110-240V IP67 Classe II selv.	Power supply 24V 10W / 110-240V IP67 Class II selv.	Spot / Pole *RF25757		
Alimentatore per installazione remota 24Vdc 20W / 220-240V IP67 Classe II selv.	Power supply for remote installation 24Vdc 20W / 220-240V IP67 Class II selv.	Pole / Wall *RF25752		
Alimentatore 24Vdc 35W / 120-270V IP67 Classe II selv.	Power supply 24Vdc 35W / 120-270V IP67 Class II selv.	F990B23AZ00		
Alimentatore per installazione remota 24Vdc 50W / 120-240V IP67 Classe II selv.	Power supply for remote installation 24Vdc 50W / 120-240V IP67 Class II selv.	*RF25755		
Alimentatore per installazione remota 24Vdc 70W / 220-240V IP67 Classe II selv.	Power supply for remote installation 24Vdc 70W / 220-240V IP67 Class II selv.	*RF25749		

Aimer 1 Aqua

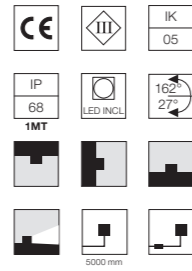
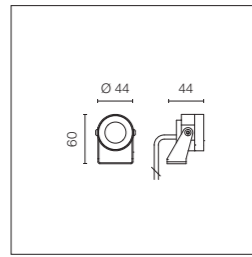

Sorgente a LED inclusa. Corpo e staffa in acciaio inox 316L adatti per l'immersione. Alimentazione elettrica remota 350mA ON/OFF e dimmerabile 1-10V o DALI da ordinare separatamente. Connessione in serie. Dotato di spezzone di cavo uscente in neoprene di 5000 mm e kit con connettori crimp e guaina termorestringente adesiva per connessione a tenuta stagna. Staffa di fissaggio inclusa. Vetro trasparente extrachiaro. Picchetto per installazione a terra da ordinare separatamente. 2700K e 3000K a richiesta.

LED source. 316L stainless steel body and bracket, suitable for submersion. Remote power supply 350 mA ON/OFF and dimmable 1-10V or DALI. Must be ordered separately. Serial connection. Equipped with a 5000 mm protruding section of neoprene cable and a kit with crimpable connectors and adhesive heat-shrinkable sleeves that guarantee the tightness of the connection. Extraclear transparent glass. The metal nail for ground installation needs to be ordered separately. 2700K and 3000K models available upon request.

Optic Medium 30°

Power Led: 1,1W - LED 120 lm ≠ OUTPUT 99 lm - 3000K/CRI 80 - 350 mA / 1,1W - 124 lm ≠ OUTPUT 103 lm - 4000K/CRI 80 - 350 mA

3000K

● FA10517114557

4000K

● FA10517114357

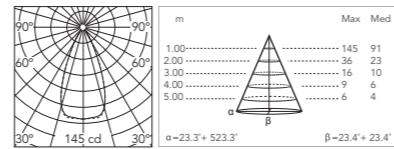

@ 4000K

* Numero massimo di apparecchi per alimentatore / Maximum number of luminaires per power supply.

Numero massimo di apparecchi per alimentatore (Vin220÷240). Dati indicativi da verificare con le specifiche condizioni di installazione.

Maximum number of luminaires per power supply. (220÷240 V). These data must be checked taking into account the specific installation conditions.

Acc. RF25748 6
Acc. FA184 **16
Acc. FA238 **9

**La tensione ai capi del sistema è in funzione del numero di apparecchi collegati in serie, attenersi alle norme CEI 64-8.

**The voltage at the end of the system depends on the number of fixtures connected in series, please comply with CEI 64-8 standards.

Aimer 1 Aqua RGB

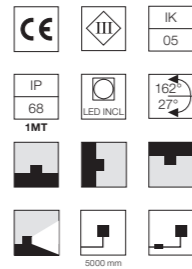
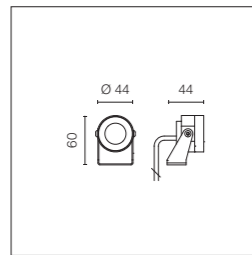

Sorgente RGB a LED inclusa. Corpo e staffa in acciaio inox 316L adatti per l'immersione. Alimentazione elettrica remota con interfaccia DMX 3CHx350mA da ordinare separatamente. Connessione in serie. Dotato di spezzone di cavo uscente in neoprene di 5000 mm e kit con connettori crimp e guaina termorestringente adesiva per connessione a tenuta stagna. Staffa di fissaggio inclusa. Picchetto per installazione a terra da ordinare separatamente. Vetro sabbiato.

RGB LED source included. 316L stainless steel body and bracket, suitable for submersion. Remote electrical power supply with DMX 3CHx350mA interface to be ordered separately. Serial connection. Equipped with a 5000 mm protruding section of neoprene cable and a kit with crimpable connectors and adhesive heat-shrinkable sleeves that guarantee the tightness of the connection. Frosted glass. Fixing bracket included. The metal nail for ground installation needs to be ordered separately.

Schema elettrico e installazione sistema RGB.

Massimo 10 apparecchi Aimer 1 Aqua RGB per ogni codice F990B22A000.

Vedere Schema Elettrico n.5 Pagina 670.

Wiring diagram and installation scheme RGB.

Max 10 luminaires Aimer 1 Aqua RGB per each code F990B22A000.

See Wiring Diagram n.5 Page 670.

RGB Power Led: 3,4W - 3CH x 350mA

RGB

● FA10517314357

Photometric data on request.

* Numero massimo di apparecchi per alimentatore / Maximum number of luminaires per power supply.

Numero massimo di apparecchi per alimentatore (Vin220÷240). Dati indicativi da verificare con le specifiche condizioni di installazione.

Maximum number of luminaires per power supply. (220÷240 V). These data must be checked taking into account the specific installation conditions.

Acc. F990B22A000 **10

**La tensione ai capi del sistema è in funzione del numero di apparecchi collegati in serie, attenersi alle norme CEI 64-8.

**The voltage at the end of the system depends on the number of fixtures connected in series, please comply with CEI 64-8 standards.

Aimer 3 Aqua

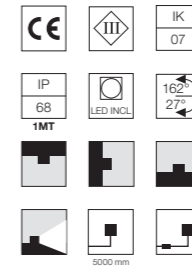
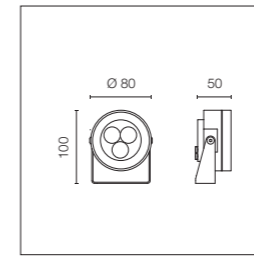

Sorgente a LED inclusa. Corpo e staffa in acciaio inox 316L adatti per l'immersione. Alimentazione elettrica remota 24V dc ON/OFF da ordinare separatamente. Connessione in parallelo. Dotato di spezzone di cavo uscente in neoprene di 5000 mm e kit con connettori crimp e guaina termorestringente adesiva per connessione a tenuta stagna. Staffa di fissaggio inclusa. Vetro trasparente extrachiaro. Picchetto per installazione a terra da ordinare separatamente. 2700K e 3000K a richiesta.

LED source included. 316L stainless steel body and bracket, suitable for submersion. Remote electrical power supply 24V dc ON/OFF to be ordered separately. Parallel connection. Equipped with a 5000 mm protruding section of neoprene cable and a kit with crimpable connectors and adhesive heat-shrinkable sleeves that guarantee the tightness of the connection. Fixing bracket included. Extraclear transparent glass. The metal nail for ground installation needs to be ordered separately. 2700K and 3000K models available upon request.

Optic Medium 50°

Power Led: 3,3W - 359 lm ≠ OUTPUT 267 lm - 3000K/CRI 80 - 24Vdc / 3,3W - 373 lm ≠ OUTPUT 278 lm - 4000K/CRI 80 - 24Vdc

3000K

● FA10517214657

4000K

● FA10517214457

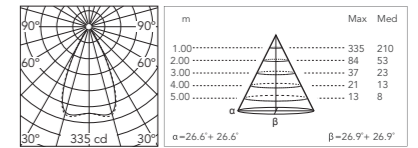

@ 4000K

* Numero massimo di apparecchi per alimentatore / Maximum number of luminaires per power supply.

Numero massimo di apparecchi per alimentatore (Vin220÷240). Dati indicativi da verificare con le specifiche condizioni di installazione.

Maximum number of luminaires per power supply. (220÷240 V). These data must be checked taking into account the specific installation conditions.

Acc. RF25748 1
Acc. RF25757 2
Acc. RF25752 3

Acc. RF25755 7
Acc. RF25749 14

Aimer 3 Aqua RGB

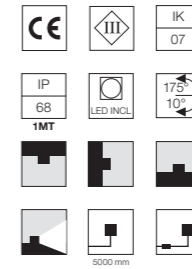
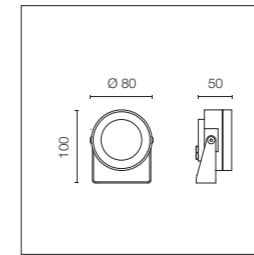

Sorgente RGB a LED inclusa. Corpo e staffa in acciaio inox 316L adatti per l'immersione. Alimentazione elettrica remota con interfaccia DMX 3CHx350mA da ordinare separatamente. Connessione in serie. Dotato di spezzone di cavo uscente in neoprene di 5000 mm e kit con connettori crimp e guaina termorestringente adesiva per connessione a tenuta stagna. Staffa di fissaggio inclusa. Picchetto per installazione a terra da ordinare separatamente. Vetro sabbiato.

RGB LED source included. 316L stainless steel body and bracket, suitable for submersion. Remote electrical power supply with DMX 3CHx350mA interface to be ordered separately. Serial connection. Equipped with a 5000 mm protruding section of neoprene cable and a kit with crimpable connectors and adhesive heat-shrinkable sleeves that guarantee the tightness of the connection. Frosted glass. Fixing bracket included. The metal nail for ground installation needs to be ordered separately.

Schema elettrico e installazione sistema RGB.

Massimo 10 apparecchi Aimer 3 Aqua RGB per ogni codice F990B22A000.

Vedere Schema Elettrico n.5 Pagina 670.

Wiring diagram and installation scheme RGB.

Max 10 luminaires Aimer 3 Aqua RGB per each code F990B22A000.

See Wiring Diagram n.5 Page 670.

Optic Medium 35°

RGB Power Led: 3,4W - 3CH x 350mA

RGB

● FA10517414457

Photometric data on request.

* Numero massimo di apparecchi per alimentatore / Maximum number of luminaires per power supply.

Numero massimo di apparecchi per alimentatore (Vin220÷240). Dati indicativi da verificare con le specifiche condizioni di installazione.

Maximum number of luminaires per power supply. (220÷240 V). These data must be checked taking into account the specific installation conditions.

Acc. F990B22A000 **10

**La tensione ai capi del sistema è in funzione del numero di apparecchi collegati in serie, attenersi alle norme CEI 64-8.

**The voltage at the end of the system depends on the number of fixtures connected in series, please comply with CEI 64-8 standards.

Aimer 4 Aqua

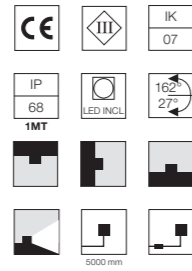
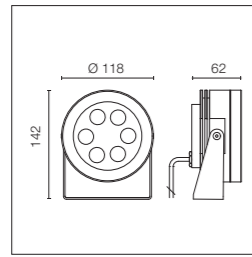

Sorgente a LED inclusa. Corpo e staffa in acciaio inox 316L adatti per l'immersione. Alimentazione elettrica remota 24V dc ON/OFF da ordinare separatamente. Connessione in parallelo. Dotato di spezzone di cavo uscente in neoprene di 5000 mm e kit con connettori crimp e guaina termorestringente adesiva per connessione a tenuta stagna. Staffa di fissaggio inclusa. Vetro trasparente extrachiario. Picchetto per installazione a terra da ordinare separatamente. 2700K e 3000K a richiesta.

LED source included. 316L stainless steel body and bracket, suitable for submersion. Remote electrical power supply 24V dc ON/OFF to be ordered separately. Parallel connection. Equipped with a 5000 mm protruding section of neoprene cable and a kit with crimpable connectors and adhesive heat-shrinkable sleeves that guarantee the tightness of the connection. Fixing bracket included. Extraclear transparent glass. The metal nail for ground installation needs to be ordered separately. 2700K and 3000K models available upon request.

Optic Medium 30°

Power Led: 9W - 646 lm ≠ OUTPUT 409 lm - 3000K/CRI 80 - 24Vdc / 9W - 687 lm ≠ OUTPUT 435 lm - 4000K/CRI 80 - 24Vdc

3000K

FA10526614757

4000K

FA10526614557

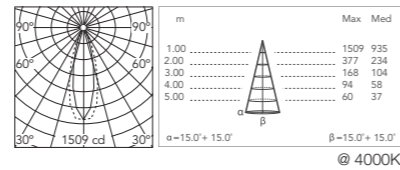

* Numero massimo di apparecchi per alimentatore / Maximum number of luminaires per power supply.

Numero massimo di apparecchi per alimentatore (Vin220±240). Dati indicativi da verificare con le specifiche condizioni di installazione.	Maximum number of luminaires per power supply. (220±240 V). These data must be checked taking into account the specific installation conditions.	Acc. RF25755	3
		Acc. RF25749	6

Aimer 5 Aqua

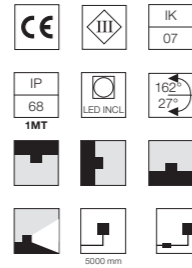
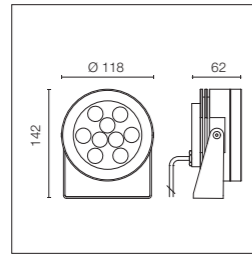

Sorgente a LED inclusa. Corpo e staffa in acciaio inox 316L adatti per l'immersione. Alimentazione elettrica remota 24V dc ON/OFF da ordinare separatamente. Connessione in parallelo. Dotato di spezzone di cavo uscente in neoprene di 5000 mm e kit con connettori crimp e guaina termorestringente adesiva per connessione a tenuta stagna. Staffa di fissaggio inclusa. Vetro trasparente extrachiario. Picchetto per installazione a terra da ordinare separatamente. 2700K e 3000K a richiesta.

LED source included. 316L stainless steel body and bracket, suitable for submersion. Remote electrical power supply 24V dc ON/OFF to be ordered separately. Parallel connection. Equipped with a 5000 mm protruding section of neoprene cable and a kit with crimpable connectors and adhesive heat-shrinkable sleeves that guarantee the tightness of the connection. Fixing bracket included. Extraclear transparent glass. The metal nail for ground installation needs to be ordered separately. 2700K and 3000K models available upon request.

Optic Medium 30°

Power Led: 14,7W - 969 lm ≠ OUTPUT 680 lm - 3000K/CRI 80 - 24Vdc / 14,7W - 1031 lm ≠ OUTPUT 723 lm - 4000K/CRI 80 - 24Vdc

3000K

FA10521114757

4000K

FA10521114557

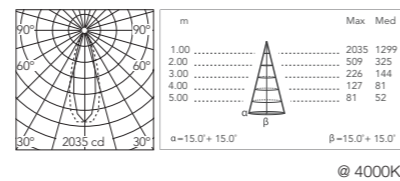

* Numero massimo di apparecchi per alimentatore / Maximum number of luminaires per power supply.

Numero massimo di apparecchi per alimentatore (Vin220±240). Dati indicativi da verificare con le specifiche condizioni di installazione.	Maximum number of luminaires per power supply. (220±240 V). These data must be checked taking into account the specific installation conditions.	Acc. RF25755	3
		Acc. RF25749	7
		Acc. FA184	1

Aimer 5 Aqua RGB

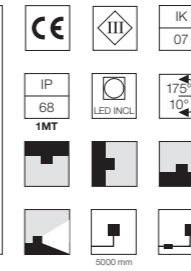
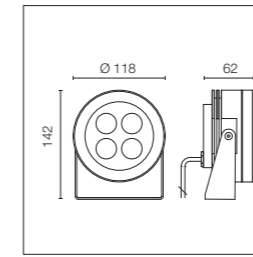

Sorgente RGB a LED inclusa. Corpo e staffa in acciaio inox 316L adatti per l'immersione. Alimentazione elettrica remota con interfaccia DMX 3CHx350mA da ordinare separatamente. Connessione in serie. Dotato di spezzone di cavo uscente in neoprene di 5000 mm e kit con connettori crimp e guaina termorestringente adesiva per connessione a tenuta stagna. Staffa di fissaggio inclusa. Picchetto per installazione a terra da ordinare separatamente. Vetro sabbato.

RGB LED source included. 316L stainless steel body and bracket, suitable for submersion. Remote electrical power supply with DMX 3CHx350mA interface to be ordered separately. Serial connection. Equipped with a 5000 mm protruding section of neoprene cable and a kit with crimpable connectors and adhesive heat-shrinkable sleeves that guarantee the tightness of the connection. Frosted glass. Fixing bracket included. The metal nail for ground installation needs to be ordered separately.

Schema elettrico e installazione sistema RGB.

Massimo 2 apparecchi Aimer 5 Aqua RGB per ogni codice F990B22A000.

Vedere Schema Elettrico n.5 Pagina 670.

Wiring diagram and installation scheme RGB.

Max 2 luminaires Aimer 5 Aqua RGB for each code F990B22A000.

See Wiring Diagram n.5 Page 670.

Optic Medium 50°

RGB Power Led: 13,6W - 3CH x 350mA

RGB





FA10525614557

Photometric data on request.

* Numero massimo di apparecchi per alimentatore / Maximum number of luminaires per power supply.

Numero massimo di apparecchi per alimentatore (Vin220±240). Dati indicativi da verificare con le specifiche condizioni di installazione.	Maximum number of luminaires per power supply. (220±240 V). These data must be checked taking into account the specific installation conditions.	Acc. *F990B22A000 **2	**La tensione ai capi del sistema è in funzione del numero di apparecchi collegati in serie, attenersi alle norme CEI 64-8.	**The voltage at the end of the system depends on the number of fixtures connected in series, please comply with CEI 64-8 standards.

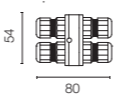
Aimer Aqua: Accessori / Accessories

Picchetto per installazione a terra.	Ground spike.	Aqua Aimer 1 / 3 / 4 / 5 FA136		
Sistema di giunzione IP68 H2O Stop anti-condensa a 3/4 vie 4 poli. (Ø5,5÷12mm cavo).	3/4 way terminal block 4 poles IP68 H2O Stop. (Ø5,5÷12mm cable).	Aqua Aimer 3 / 4 / 5 F990C010000		
Sistema di giunzione IP68 H2O Stop anti-condensa a 2 vie 4 poli. (Ø5,5÷12mm cavo).	2 way terminal block 4 poles IP68 H2O Stop. (Ø5,5÷12mm cable).	Aqua Aimer 3 / 4 / 5 F990C00A000		

Aimer Aqua: Driver / Drivers

Alimentatore 24V 8W / 110-240V IP65 Classe II selv.	Power supply 24V 8W / 110-240V IP65 Class II selv.	Aqua Aimer 1 / 3 *RF25748		
Alimentatore 16 x 1W/ 110÷240V - Iout 350mA (12x1W@110V) IP67 Class II Selv.	Power supply 16 x 1W/ 110÷240V - Iout 350mA (12x1W@110V) IP67 Class II Selv.	Aqua Aimer 1 / 5 *FA184 Dimmable Push-Dim Or 1-10V See Wiring Diagram n.3. Page 668		
Alimentatore 18W/ 110÷240V - Iout 350mA (15W@110V) IP67 Class II Selv. C	Power supply 18W/ 110÷240V - Iout 350mA (15W@110V) IP67 Class II Selv. C.	Aqua Aimer 1 / 3 *FA238 Dimmable DALI See Wiring Diagram n.3. Page 668		
Alimentatore 24V 10W / 110-240V IP67 Classe II selv.	Power supply 24V 10W / 110-240V IP67 Class II selv.	Aqua Aimer 3 / 4 / 5 *RF25757		
Alimentatore per installazione remota 24Vdc 20W / 220-240V IP67 Classe II selv.	Power supply for remote installation 24Vdc 20W / 220-240V IP67 Class II selv.	Aqua Aimer 3 / 4 / 5 *RF25752		
Alimentatore 24Vdc 35W / 120-270V IP67 Classe II selv.	Power supply 24Vdc 35W / 120-270V IP67 Class II selv.	F990B23AZ00		
Alimentatore per installazione remota 24Vdc 50W / 120-240V IP67 Classe II selv.	Power supply for remote installation 24Vdc 50W / 120-240V IP67 Class II selv.	Aqua Aimer 3 / 4 / 5 *RF25755		
Alimentatore per installazione remota 24Vdc 70W / 220-240V IP67 Classe II selv.	Power supply for remote installation 24Vdc 70W / 220-240V IP67 Class II selv.	Aqua Aimer 3 / 4 / 5 *RF25749		

Aimer Aqua RGB: Accessori / Accessories

Picchetto per installazione a terra.	Ground spike.	Aqua Aimer 1 / 3 / 4 / 5 RGB FA136		
Controller DMX a parete per scatole ad incasso (60mm interasse fori).	DMX controller; dimmer switch for recessed box (60mm hole centres).	F990B10A000		
Controller DMX stand-alone/interfaccia PC.	DMX controller; stand-alone/PC interface.	F990B11A000		
DMX splitter 512 - dispositivo elettronico per rigenerare segnale DMX monodirezionale 1 Input e 7 output, 12-24 Vdc.	DMX splitter 512 - electronic device to regenerate the monodirectional DMX signal 1 Input and 7 output, 12-24Vdc.	F990B13A000		
Cavo DMX schermato con impedenza costante 110 Ohm.	DMX cable - shielded twisted pair with 110 Ohm constant impedance.	F990B12A000		
Alimentatore con interfaccia DMX per apparecchi RGB 36W/220÷240V-3CH x 350mA (3CH x 10 x 1W) predisposizione DMX IP67 Classe I Selv Eq.	Power supply with DMX interface for RGB fixtures 36W/220÷240V-3CH x 350mA (3CH x 10 x 1W) DMX control allowed IP67 Class I Selv Eq.	*F990B22A000		

Aimer Aqua RGB: Driver / Drivers

Franco





Franco



Famiglia / Family

Franco 1



CoB Led

up to 24W
up to 1920 lm - 2700K/CRI 80
up to 2065 lm - 3000K/CRI 80
up to 2166 lm - 4000K/CRI 80

Power Led

up to 20W
up to 1506 lm - 2700K/CRI 80
up to 1619 lm - 3000K/CRI 80
up to 1698 lm - 4000K/CRI 80

Franco 2



CoB Led

up to 43W
up to 3143 lm - 2700K/CRI 80
up to 3380 lm - 3000K/CRI 80
up to 3465 lm - 4000K/CRI 80

Franco 3



CoB Led

up to 52W
up to 3757 lm - 2700K/CRI 80
up to 4040 lm - 3000K/CRI 80
up to 4142 lm - 4000K/CRI 80

Power Led

up to 43W
up to 3676 lm - 2700K/CRI 80
up to 3939 lm - 3000K/CRI 80
up to 4070 lm - 4000K/CRI 80

Descrizione / Description

Famiglia di apparecchi di illuminazione con sorgente luminosa a LED orientabili a proiezione, predisposti per installazione a parete e a palo come testapalo. Disponibile in tre tagli dimensionali e in varie ottiche per dimensione, comprese ottiche stradali per applicazioni in contesto urbano. Corpo in alluminio pressofuso lega EN AB 47100 (a basso contenuto di rame) e riflettore in alluminio superpuro. Diffusore in vetro extrachiaro con bordo serigrafato fissato alla cornice attraverso un sistema di incollaggio robotizzato. Disponibile in differenti finiture con rivestimento a doppio strato di polveri e sottoposte a trattamento di conversione chimica superficiale per una elevata resistenza alla corrosione. Staffa di fissaggio in acciaio inox AISI 316L graduata per garantire una regolazione precisa della unità emittente e una orientabilità di 120° circa sull'asse verticale. L'apparecchio è dotato di un pressacavo in metallo. Per garantire la tenuta del pressacavo è consigliabile utilizzare cavi elettrici flessibili idonei all'impiego in ambienti esterni. Completano la gamma una serie completa di pali cilindrici di diverso diametro ed altezza da interrare o con base di fissaggio e tirafondi; nella versione Franco 1 braccio a parete dedicato per l'illuminazione in oggetto di insegne.

Family of tiltable projection luminaires with LED source for wall and post mounting. Available in three dimensions and with different light beams for every dimension, including optics for urban uses. Die cast aluminum body EN AB-47100 (with low copper content) and super pure aluminum reflector. Extraclear glass diffuser with silkscreen edge, attached to the frame with a robotic gluing system. Available in different finishes, with double-layered powder coating and chemical conversion surface treatment to ensure high corrosion resistance. AISI 316L stainless steel fixing bracket, graduated to guarantee precision in the adjustment of the emission unit and a tilting of approx. 120° on the vertical axis. Completed with a metal cable guide. To ensure the tightness of the cable guide it's recommended to use flexible electric cables suitable for exterior use. Completed with a series of cylinder posts in different diameters and heights that can be ground recessed or fixed with an anchor plate and lag screws. The MiniFranco version is equipped with a protruding arm for wall mounting and sign lighting.

Colori / Colours



01 White



06 Grey



12 Forest Green

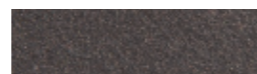

18 Deep Brown



30 Black

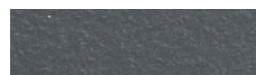

33 Anthracite

Franco 1 CoB Led

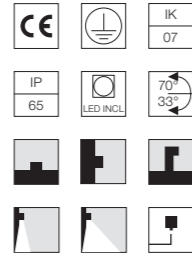
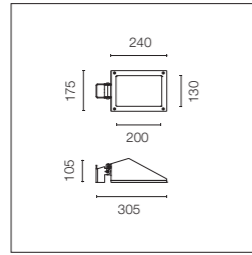

Sorgente a LED inclusa. Alimentazione elettrica 220-240V ON/OFF integrata. Staffa di fissaggio inclusa. Dotato di pressacavo in metallo M16x1,5 (per cavi 4,5mmϕ<math><10\text{mm}</math>) e connettore IP68. Per garantire la tenuta del pressacavo è consigliabile utilizzare cavi elettrici flessibili idonei all'impiego in ambienti esterni. Accessori opzionali: paletti; pali e relativi bracci per installazione come testapalo; braccio in oggetto a parete.

LED source included. Integrated electrical power supply 220-240V ON/OFF. Fixing bracket included. Equipped with a M16x1.5 cable guide (for 4.5mmϕ<math><10\text{mm}</math> cables) and IP68 connector. To ensure the tightness of the cable guide it's recommended to use flexible electric cables suitable for exterior use. Optional accessories: posts; mounts and arms to install as a mast; protruding arm for wall mounting.

Symmetric Optic

CoB Led: 24W - 2856 lm \neq OUTPUT 1920 lm - 2700K/CRI 80 - 24Vdc / 24W - 3071 lm \neq OUTPUT 2065 lm - 3000K/CRI 80 - 24Vdc / 24W - 3221 lm \neq OUTPUT 2166 lm - 4000K/CRI 80 - 24Vdc

- | | | |
|---------------|---------------|---------------|
| 2700K | 3000K | 4000K |
| ○ FA162812301 | ○ FA162811301 | ○ FA162801301 |
| ● FA162812306 | ● FA162811306 | ● FA162801306 |
| ● FA162812312 | ● FA162811312 | ● FA162801312 |
| ● FA162812318 | ● FA162811318 | ● FA162801318 |
| ● FA162812330 | ● FA162811330 | ● FA162801330 |
| ● FA162812333 | ● FA162811333 | ● FA162801333 |

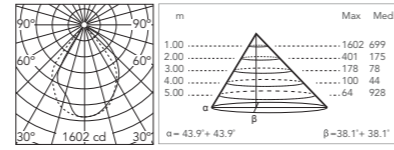

@ 3000K

Asymmetric Optic

CoB Led: 24W - 2856 lm \neq OUTPUT 1506 lm - 2700K/CRI 80 - 24Vdc / 24W - 3071 lm \neq OUTPUT 1619 lm - 3000K/CRI 80 - 24Vdc / 24W - 3221 lm \neq OUTPUT 1698 lm - 4000K/CRI 80 - 24Vdc

- | | | |
|---------------|---------------|---------------|
| 2700K | 3000K | 4000K |
| ○ FA162812401 | ○ FA162811401 | ○ FA162801401 |
| ● FA162812406 | ● FA162811406 | ● FA162801406 |
| ● FA162812412 | ● FA162811412 | ● FA162801412 |
| ● FA162812418 | ● FA162811418 | ● FA162801418 |
| ● FA162812430 | ● FA162811430 | ● FA162801430 |
| ● FA162812433 | ● FA162811433 | ● FA162801433 |

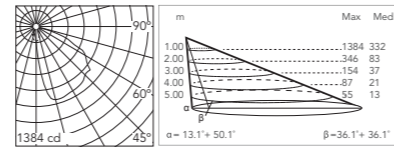

@ 3000K

Franco 1 Power Led

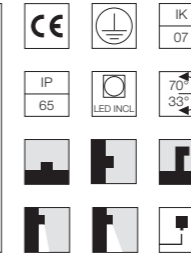
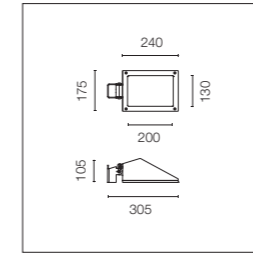

Sorgente a LED inclusa. Alimentazione elettrica 220-240V ON/OFF integrata. Staffa di fissaggio inclusa. Dotato di pressacavo in metallo M16x1,5 (per cavi 4,5mmϕ<math><10\text{mm}</math>) e connettore IP68. Per garantire la tenuta del pressacavo è consigliabile utilizzare cavi elettrici flessibili idonei all'impiego in ambienti esterni. Accessori opzionali: paletti; pali e relativi bracci per installazione come testapalo; braccio in oggetto a parete.

LED source included. Integrated electrical power supply 220-240V ON- OFF. Fixing bracket included. Equipped with a M16x1.5 cable guide (for 4.5mmϕ<math><10\text{mm}</math> cables) and IP68 connector. To ensure the tightness of the cable guide it's recommended to use flexible electric cables suitable for exterior use. Optional accessories: posts; mounts and arms to install as a mast; protruding arm for wall mounting.

Optic Spot 10°

Power Led: 20W - 1776 lm \neq OUTPUT 1371 lm - 2700K/CRI 80 - 220÷240V / 20W - 1914 lm \neq OUTPUT 1486 lm - 3000K/CRI 80 - 220÷240V / 20W - 1987 lm \neq OUTPUT 1543 lm - 4000K/CRI 80 - 220÷240V

- | | | |
|---------------|---------------|---------------|
| 2700K | 3000K | 4000K |
| ○ FA161012201 | ○ FA161011201 | ○ FA162241201 |
| ● FA161012206 | ● FA161011206 | ● FA162241206 |
| ● FA161012212 | ● FA161011212 | ● FA162241212 |
| ● FA161012218 | ● FA161011218 | ● FA162241218 |
| ● FA161012230 | ● FA161011230 | ● FA162241230 |
| ● FA161012233 | ● FA161011233 | ● FA162241233 |

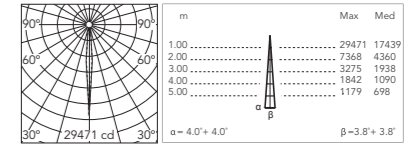

@ 3000K

Optic Medium 40°

Power Led: 20W - 1776 lm \neq OUTPUT 1281 lm - 2700K/CRI 80 - 220÷240V / 20W - 1914 lm \neq OUTPUT 1388 lm - 3000K/CRI 80 - 220÷240V / 20W - 1987 lm \neq OUTPUT 1442 lm - 4000K/CRI 80 - 220÷240V

- | | | |
|---------------|---------------|---------------|
| 2700K | 3000K | 4000K |
| ○ FA161012301 | ○ FA161011301 | ○ FA162241301 |
| ● FA161012306 | ● FA161011306 | ● FA162241306 |
| ● FA161012312 | ● FA161011312 | ● FA162241312 |
| ● FA161012318 | ● FA161011318 | ● FA162241318 |
| ● FA161012330 | ● FA161011330 | ● FA162241330 |
| ● FA161012333 | ● FA161011333 | ● FA162241333 |

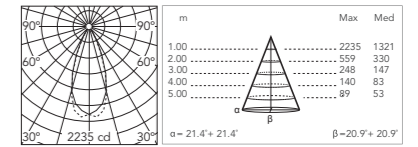

@ 3000K

Franco 1 / Ø 60mm - Poles

Con Base
Completo di aggancio testa palo fisso. Proiettore non orientabile

With Base
With fixed pole head hooking. Non-adjustable projector



H 500mm

- FA100501
- FA100506
- FA100512
- FA100518
- FA100530
- FA100533

H 900mm

- FA100901
- FA100906
- FA100912
- FA100918
- FA100930
- FA100933

H 2000mm

- FA11701
- FA11706
- FA11712
- FA11718
- FA11730
- FA11733

Da Interrare (+300 mm Interrati)

In-Ground (+300 mm Root)



H 500mm

- FA110501
- FA110506
- FA110512
- FA110518
- FA110530
- FA110533

H 900mm

- FA110901
- FA110906
- FA110912
- FA110918
- FA110930
- FA110933

Franco 1 / Ø 76mm - Poles

Con Base e Portella con Morsettiera.

With Base and Access Door.
With Terminal Block 4x1,5-16mmq.



H 3500mm

- FA24806
- FA24833

H 4500mm

- FA24906
- FA24933

Da Interrare (+500 mm Interrati) e Portella con Morsettiera

In-Ground (+500 mm Root) With Access Door
With Terminal Block 4x1,5-16mmq

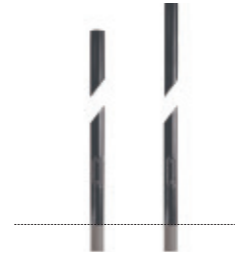

H 3500mm

- FA25006
- FA25033

H 4500mm

- FA25106
- FA25133

Franco 1 / Ø 102mm - Poles

Con Base e Portella con Morsettiera.

With Base and Access Door .
With Terminal Block 4x1,5-16mmq.



H 4000mm

- FA414006
- FA414033

H 5000mm

- FA415006
- FA415033

Da Interrare (+500 mm Interrati) e Portella con Morsettiera

In-Ground (+500 mm Root) With Access Door
With Terminal Block 4x1,5-16mmq

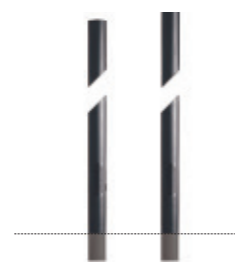

H 4000mm

- FA414506
- FA414533

H 5000mm

- FA415506
- FA415533

Installation scheme: Franco 1

Proiettore a Parete Orientabile / Adjustable Projector on Wall





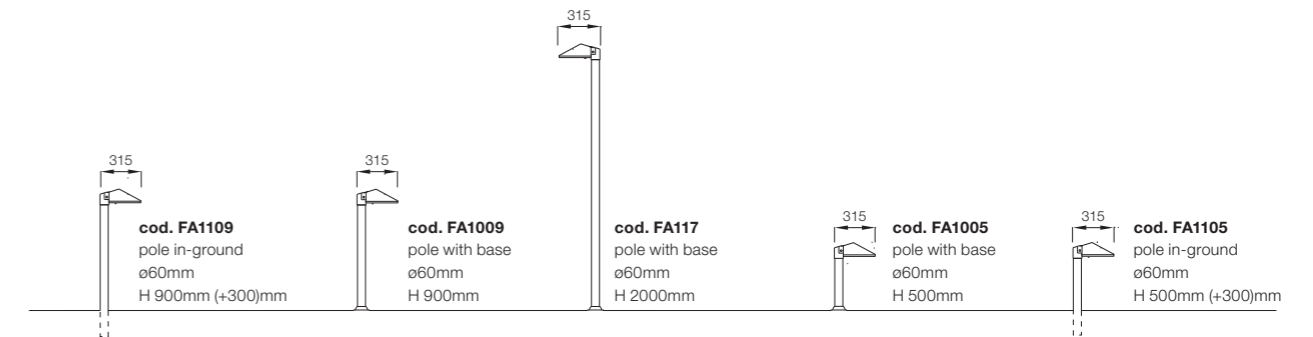

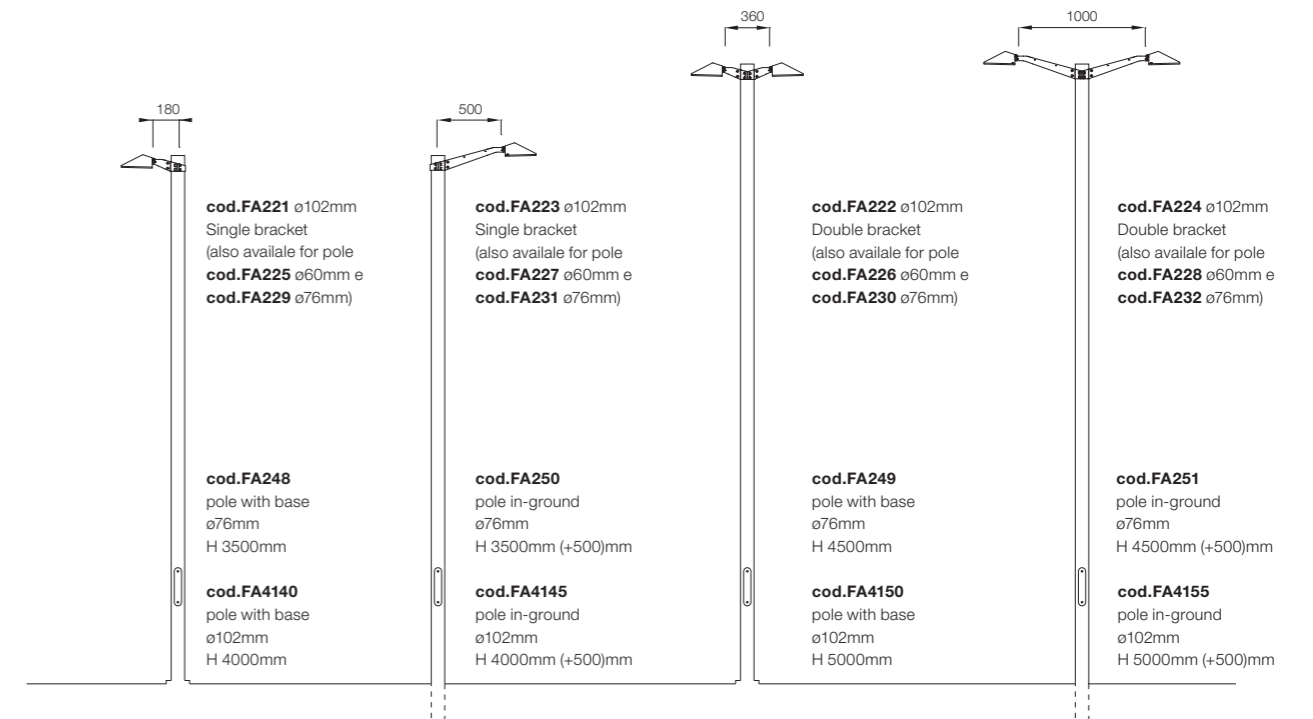

Proiettore a Palo Non Orientabile / Non-Adjustable Projector on Pole



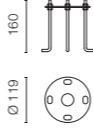

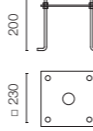

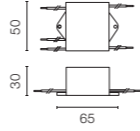

Proiettore a Palo Orientabile / Adjustable Projector on Pole

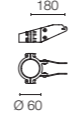

Franco 1: Accessori / Accessories

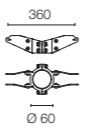
Piastra tirafondi.	Base plate with bolt.	H: 500 / 900 / 2000mm FA243		
Piastra tirafondi.	Base plate with bolt.	H: 3500 / 4500mm with base FA116		
Braccio 620mm.	Wall bracket 620mm.	○ FA8801 ● FA8806 ● FA8812 ● FA8818 ● FA8830 ● FA8833		
Dispositivo di protezione per il sovraccarico. 275Vac. Corrente massima di scarica 10KA (8/29µs). Massima corrente operativa 5A. Adatto per la connessione in serie. IP66.	Surge protection device. 275Vac. Maximum discharge current 10KA (8/20µs). Maximum operating current 5A. Suitable for series connection. IP66.	F990E00A000		

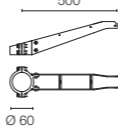
Franco 1 Ø 60mm

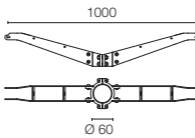
Braccio singolo 180mm. Per palo Ø 60mm.	Single bracket 180mm. For pole Ø 60mm.	● FA22506 ● FA22533		
Braccio doppio 180mm. Per palo Ø 60mm.	Double bracket 180mm. For pole Ø 60mm.	● FA22606 ● FA22633		
Braccio singolo 500mm. Per palo Ø 60mm.	Single bracket 500mm. For pole Ø 60mm.	● FA22706 ● FA22733		
Braccio doppio 500mm. Per palo Ø 60mm.	Double bracket 500mm. For pole Ø 60mm.	● FA22806 ● FA22833		

Franco 1 Ø 76mm

Braccio singolo 180mm. Per palo Ø 76mm.	Single bracket 180mm. For pole Ø 76mm.	● FA22906 ● FA22933		
Braccio doppio 180mm. Per palo Ø 76mm.	Double bracket 180mm. For pole Ø 76mm.	● FA23006 ● FA23033		
Braccio singolo 500mm. Per palo Ø 76mm.	Single bracket 500mm. For pole Ø 76mm.	● FA23106 ● FA23133		
Braccio doppio 500mm. Per palo Ø 76mm.	Double bracket 500mm. For pole Ø 76mm.	● FA23206 ● FA23233		

Franco 1 Ø 102mm

Braccio singolo 180mm. Per palo Ø 102mm.	Single bracket 180mm. For pole Ø 102mm.	● FA22106 ● FA22133		
Braccio doppio 180mm. Per palo Ø 102mm.	Double bracket 180mm. For pole Ø 102mm.	● FA22206 ● FA22233		
Braccio singolo 500mm. Per palo Ø 102mm.	Single bracket 500mm. For pole Ø 102mm.	● FA22306 ● FA22333		
Braccio doppio 500mm. Per palo Ø 102mm.	Double bracket 500mm. For pole Ø 102mm.	● FA22406 ● FA22433		

Franco 2 CoB Led

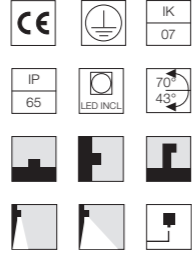
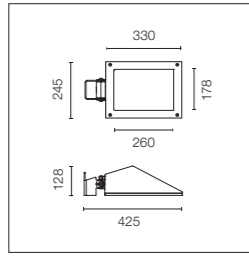

Sorgente a LED inclusa. Alimentazione elettrica 220-240V ON/OFF integrata. Staffa di fissaggio inclusa. Dotato di pressacavo in metallo M16x1,5 (per cavi 4,5mmϕ<math><10\text{mm}</math>). Per garantire la tenuta del pressacavo è consigliabile utilizzare cavi elettrici flessibili idonei all'impiego in ambienti esterni. Accessori opzionali: paletti; pali e relativi bracci per installazione come testapalo; braccio in oggetto a parete.

LED source included. Integrated electrical power supply 220-240V ON/OFF. Graduated fixing bracket included. Equipped with a M20x1.5 cable guide (for 7mmϕ<math><13\text{mm}</math> cables) and IP68 connector. To ensure the tightness of the cable guide it's recommended to use flexible electric cables suitable for exterior use. Optional accessories: posts and arms for mast mounting.

Symmetric Optic

CoB Led: 43W - 5043 lm \neq OUTPUT 3143 lm - 2700K/CRI 80 - 220 \pm 240V / 43W - 5423 lm \neq OUTPUT 3380 lm - 3000K/CRI 80 - 220 \pm 240V / 43W - 5560 lm \neq OUTPUT 3465 lm - 4000K/CRI 80 - 220 \pm 240V

2700K

- FA962832301
- FA962832306
- FA962832312
- FA962832318
- FA962832330
- FA962832333

3000K

- FA962831301
- FA962831306
- FA962831312
- FA962831318
- FA962831330
- FA962831333

4000K

- FA962821301
- FA962821306
- FA962821312
- FA962821318
- FA962821330
- FA962821333

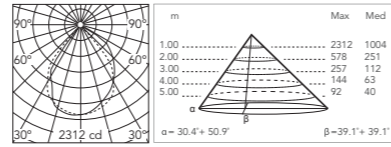

@ 3000K

Asymmetric Optic

CoB Led: 43W - 5043 lm \neq OUTPUT 2648 lm - 2700K/CRI 80 - 220 \pm 240V / 43W - 5423 lm \neq OUTPUT 2847 lm - 3000K/CRI 80 - 220 \pm 240V / 43W - 5560 lm \neq OUTPUT 2919 lm - 4000K/CRI 80 - 220 \pm 240V

2700K

- FA962832401
- FA962832406
- FA962832412
- FA962832418
- FA962832430
- FA962832433

3000K

- FA962831401
- FA962831406
- FA962831412
- FA962831418
- FA962831430
- FA962831433

4000K

- FA962821401
- FA962821406
- FA962821412
- FA962821418
- FA962821430
- FA962821433

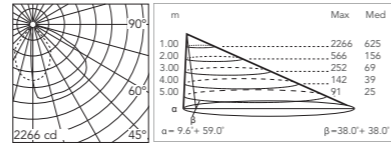

@ 3000K

Franco 2 / Ø 76mm - Poles

Con Base e Portella con Morsettieria.

With Base and Access Door .
With Terminal Block 4x1,5-16mmq.



H 3500mm

- FA24806
- FA24833

H 4500mm

- FA24906
- FA24933

Da Interrare (+500 mm Interrati) e Portella con Morsettieria

In-Ground (+500 mm Root) With Access Door
With Terminal Block 4x1,5-16mmq



H 3500mm

- FA25006
- FA25033

H 4500mm

- FA25106
- FA25133

Franco 2 / Ø 102mm - Poles

Con Base e Portella con Morsettieria.

With Base and Access Door .
With Terminal Block 4x1,5-16mmq.



H 4000mm

- FA414006
- FA414033

H 5000mm

- FA415006
- FA415033

Da Interrare (+500 mm Interrati) e Portella con Morsettieria

In-Ground (+500 mm Root) With Access Door
With Terminal Block 4x1,5-16mmq



H 4000mm

- FA414506
- FA414533



H 5000mm

- FA415506
- FA415533

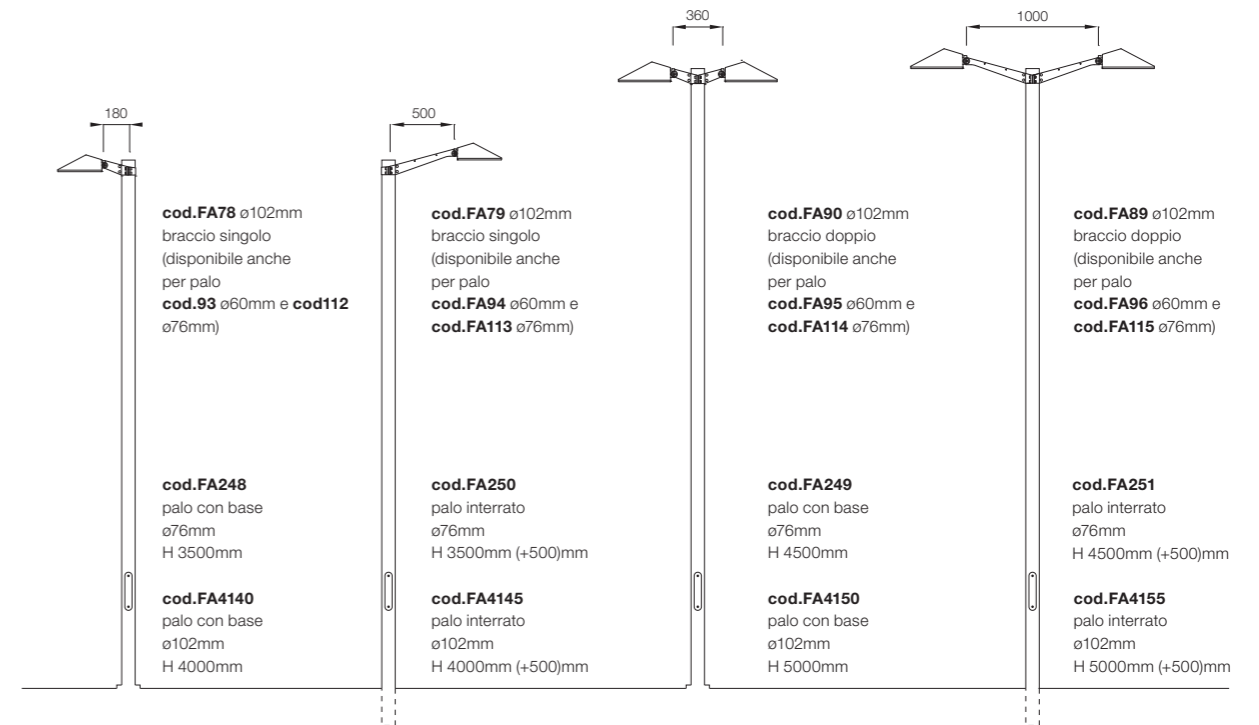
Installation scheme: Franco 2

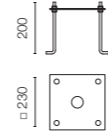

Franco 2: Accessori / Accessories

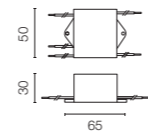
Piastra tirafondi.	Base plate with bolt.	FA116		
Dispositivo di protezione per il sovraccarico. 275Vac. Corrente massima di scarica 10KA (8/29µs). Massima corrente operativa 5A. Adatto per la connessione in serie. IP66.	Surge protection device. 275Vac. Maximum discharge current 10KA (8/20µs). Maximum operating current 5A. Suitable for series connection. IP66.	CoB LED F990E00A000		

Franco 2 Ø 60mm

Braccio singolo 180mm. Per palo Ø 60mm.	Single bracket 180mm. For pole Ø 60mm.	● FA9306 ● FA9333		
Braccio doppio 180mm Per palo Ø 60mm.	Double bracket 180mm. For pole Ø 60mm.	● FA9506 ● FA9533		
Braccio singolo 500mm. Per palo Ø 60mm.	Single bracket 500mm. For pole Ø 60mm.	● FA9406 ● FA9433		
Braccio doppio 500mm Per palo Ø 60mm.	Double bracket 500mm. For pole Ø 60mm.	● FA9606 ● FA9633		

Franco 2 Ø 76mm

Braccio singolo 180mm. Per palo Ø 76mm.	Single bracket 180mm. For pole Ø 76mm.	● FA11206 ● FA11233		
Braccio doppio 180mm Per palo Ø 76mm.	Double bracket 180mm. For pole Ø 76mm.	● FA11406 ● FA11433		
Braccio singolo 500mm. Per palo Ø 76mm.	Single bracket 500mm. For pole Ø 76mm.	● FA11306 ● FA11333		
Braccio doppio 500mm Per palo Ø 76mm.	Double bracket 500mm. For pole Ø 76mm.	● FA11506 ● FA11533		

Franco 2 Ø 102mm

Braccio singolo 180mm. Per palo Ø 102mm.	Single bracket 180mm. For pole Ø 102mm.	● FA7806 ● FA7833		
Braccio doppio 180mm Per palo Ø 102mm.	Double bracket 180mm. For pole Ø 102mm.	● FA9006 ● FA9033		
Braccio singolo 500mm. Per palo Ø 102mm.	Single bracket 500mm. For pole Ø 102mm.	● FA7906 ● FA7933		
Braccio doppio 500mm Per palo Ø 102mm.	Double bracket 500mm. For pole Ø 102mm.	● FA8906 ● FA8933		

Franco 3 CoB Led

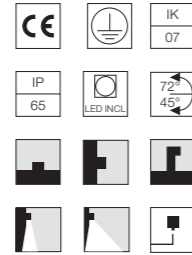
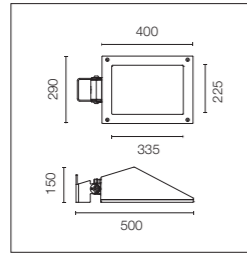
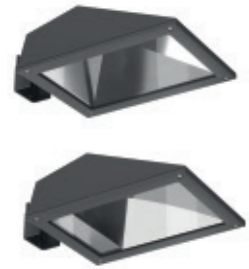

Sorgente a LED inclusa. Alimentazione elettrica 220-240V ON/OFF integrata. Staffa di fissaggio inclusa. Dotato di pressacavo in metallo M16x1,5 (per cavi 4,5mmϕ<math><10\text{mm}</math>). Per garantire la tenuta del pressacavo è consigliabile utilizzare cavi elettrici flessibili idonei all'impiego in ambienti esterni. Accessori opzionali: paletti; pali e relativi bracci per installazione come testapalo; braccio in oggetto a parete.

LED source included. Integrated electrical power supply 220-240V ON/OFF. Graduated fixing bracket included. Equipped with a M20x1.5 cable guide (for 7mmϕ<math><13\text{mm}</math> cables) and IP68 connector. To ensure the tightness of the cable guide it's recommended to use flexible electric cables suitable for exterior use. Optional accessories: posts and arms for mast mounting.

Symmetric Optic

CoB Led: 52W - 5847 lm \neq OUTPUT 3757 lm - 2700K/CRI 80 - 220÷240V / 52W - 6287 lm \neq OUTPUT 4040 lm - 3000K/CRI 80 - 220÷240V / 52W - 6446 lm \neq OUTPUT 4142 lm - 4000K/CRI 80 - 220÷240V

2700K

- FA972842301
- FA972842306
- FA972842312
- FA972842318
- FA972842330
- FA972842333

3000K

- FA972851301
- FA972851306
- FA972851312
- FA972851318
- FA972851330
- FA972851333

4000K

- FA972841301
- FA972841306
- FA972841312
- FA972841318
- FA972841330
- FA972841333

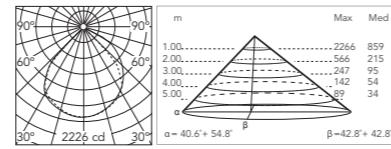

@ 3000K

Asymmetric Optic

CoB Led: 52W - 5847 lm \neq OUTPUT 3072 lm - 2700K/CRI 80 - 220÷240V / 52W - 6287 lm \neq OUTPUT 3303 lm - 3000K/CRI 80 - 220÷240V / 52W - 6446 lm \neq OUTPUT 3386 lm - 4000K/CRI 80 - 220÷240V

2700K

- FA942842401
- FA942842406
- FA942842412
- FA942842418
- FA942842430
- FA942842433

3000K

- FA942851401
- FA942851406
- FA942851412
- FA942851418
- FA942851430
- FA942851433

4000K

- FA972841401
- FA972841406
- FA972841412
- FA972841418
- FA972841430
- FA972841433

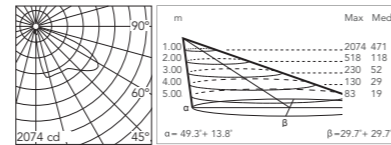

@ 3000K

Franco 3 Power Led

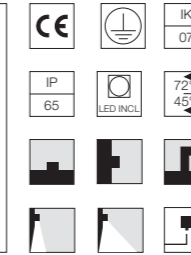
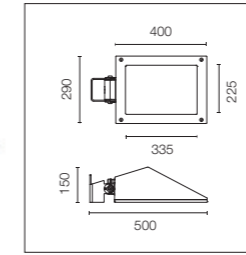

Sorgente a LED inclusa. Alimentazione elettrica 220-240V ON/OFF integrata. Staffa di fissaggio inclusa. Dotato di pressacavo in metallo M16x1,5 (per cavi 4,5mmϕ<math><10\text{mm}</math>). Per garantire la tenuta del pressacavo è consigliabile utilizzare cavi elettrici flessibili idonei all'impiego in ambienti esterni. Accessori opzionali: paletti; pali e relativi bracci per installazione come testapalo; braccio in oggetto a parete.

LED source included. Integrated electrical power supply 220-240V ON/OFF. Graduated fixing bracket included. Equipped with a M20x1.5 cable guide (for 7mmϕ<math><13\text{mm}</math> cables) and IP68 connector. To ensure the tightness of the cable guide it's recommended to use flexible electric cables suitable for exterior use. Optional accessories: posts and arms for mast mounting.

Asymmetric Optic

Power Led: 43W - 5775 lm \neq OUTPUT 3676 lm - 2700K/CRI 80 - 220÷240V / 43W - 5589 lm \neq OUTPUT 3939 lm - 3000K/CRI 80 - 220÷240V / 43W - 5216 lm \neq OUTPUT 4070 lm - 4000K/CRI 80 - 220÷240V

2700K

- Non Dimmable
- FA972472301
 - FA972472306
 - FA972472312
 - FA972472318
 - FA972472330
 - FA972472333
- 1-10V
- FA972472301-310
 - FA972472306-310
 - FA972472312-310
 - FA972472318-310
 - FA972472330-310
 - FA972472333-310
- Dali
- FA972472301-300
 - FA972472306-300
 - FA972472312-300
 - FA972472318-300
 - FA972472330-300
 - FA972472333-300

3000K

- Non Dimmable
- FA972481301
 - FA972481306
 - FA972481312
 - FA972481318
 - FA972481330
 - FA972481333
- 1-10V
- FA972481301-310
 - FA972481306-310
 - FA972481312-310
 - FA972481318-310
 - FA972481330-310
 - FA972481333-310
- Dali
- FA972481301-300
 - FA972481306-300
 - FA972481312-300
 - FA972481318-300
 - FA972481330-300
 - FA972481333-300

4000K

- Non Dimmable
- FA972471301
 - FA972471306
 - FA972471312
 - FA972471318
 - FA972471330
 - FA972471333
- 1-10V
- FA972471301-310
 - FA972471306-310
 - FA972471312-310
 - FA972471318-310
 - FA972471330-310
 - FA972471333-310
- Dali
- FA972471301-300
 - FA972471306-300
 - FA972471312-300
 - FA972471318-300
 - FA972471330-300
 - FA972471333-300

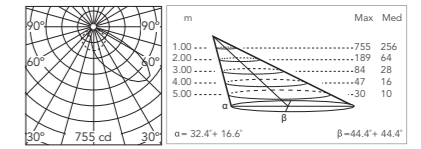

@ 3000K

Street Light Optic

Power Led: 43W - 5775 lm \neq OUTPUT 3130 lm - 2700K/CRI 80 - 220÷240V / 43W - 5589 lm \neq OUTPUT 3354 lm - 3000K/CRI 80 - 220÷240V / 43W - 5216 lm \neq OUTPUT 3466 lm - 4000K/CRI 80 - 220÷240V

2700K

- Non Dimmable
- FA972472401
 - FA972472406
 - FA972472412
 - FA972472418
 - FA972472430
 - FA972472433
- 1-10V
- FA972472401-310
 - FA972472406-310
 - FA972472412-310
 - FA972472418-310
 - FA972472430-310
 - FA972472433-310
- Dali
- FA972472401-300
 - FA972472406-300
 - FA972472412-300
 - FA972472418-300
 - FA972472430-300
 - FA972472433-300

3000K

- Non Dimmable
- FA972481401
 - FA972481406
 - FA972481412
 - FA972481418
 - FA972481430
 - FA972481433
- 1-10V
- FA972481401-310
 - FA972481406-310
 - FA972481412-310
 - FA972481418-310
 - FA972481430-310
 - FA972481433-310
- Dali
- FA972481401-300
 - FA972481406-300
 - FA972481412-300
 - FA972481418-300
 - FA972481430-300
 - FA972481433-300

4000K

- Non Dimmable
- FA972471401
 - FA972471406
 - FA972471412
 - FA972471418
 - FA972471430
 - FA972471433
- 1-10V
- FA972471401-310
 - FA972471406-310
 - FA972471412-310
 - FA972471418-310
 - FA972471430-310
 - FA972471433-310
- Dali
- FA972471401-300
 - FA972471406-300
 - FA972471412-300
 - FA972471418-300
 - FA972471430-300
 - FA972471433-300

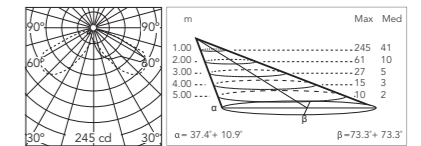

@ 3000K

Franco 3 / Ø 76mm - Poles

Con Base e Portella con Morsettiera.

With Base and Access Door .
With Terminal Block 4x1,5-16mmq.



H 3500mm

- FA24806
- FA24833

H 4500mm

- FA24906
- FA24933

Da Interrare (+500 mm Interrati) e Portella con Morsettiera

In-Ground (+500 mm Root) With Access Door
With Terminal Block 4x1,5-16mmq

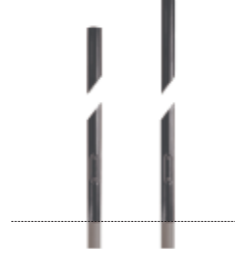

H 3500mm

- FA25006
- FA25033

H 4500mm

- FA25106
- FA25133

Franco 3 / Ø 102mm - Poles

Con Base e Portella con Morsettiera.

With Base and Access Door .
With Terminal Block 4x1,5-16mmq.



H 4000mm

- FA414006
- FA414033

H 5000mm

- FA415006
- FA415033

Da Interrare (+500 mm Interrati) e Portella con Morsettiera

In-Ground (+500 mm Root) With Access Door
With Terminal Block 4x1,5-16mmq

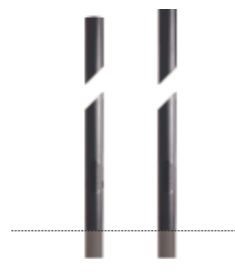

H 4000mm

- FA414506
- FA414533



H 5000mm

- FA415506
- FA415533

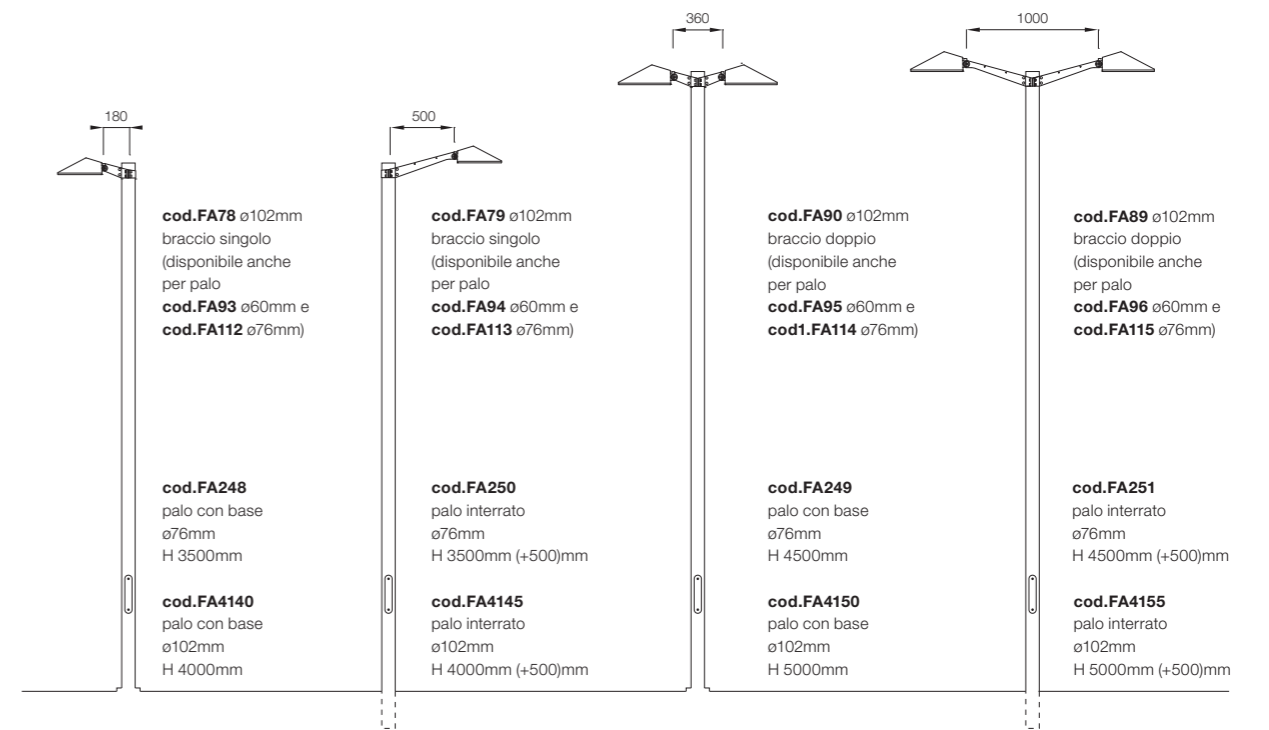
Installation scheme: Franco 3

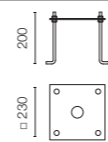

Franco 3: Accessori / Accessories

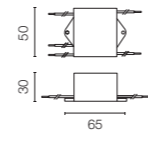
Piastra tirafondi.	Base plate with bolt.	FA116		
Dispositivo di protezione per il sovraccarico. 275Vac. Corrente massima di scarica 10KA (8/29µs). Massima corrente operativa 5A. Adatto per la connessione in serie. IP66.	Surge protection device. 275Vac. Maximum discharge current 10KA (8/20µs). Maximum operating current 5A. Suitable for series connection. IP66.	CoB LED / Power LED F990E00A000		

Franco 3 Ø 60mm

Braccio singolo 180mm. Per palo Ø 60mm.	Single bracket 180mm. For pole Ø 60mm.	● FA9306 ● FA9333		
Braccio doppio 180mm. Per palo Ø 60mm.	Double bracket 180mm. For pole Ø 60mm.	● FA9506 ● FA9533		
Braccio singolo 500mm. Per palo Ø 60mm.	Single bracket 500mm. For pole Ø 60mm.	● FA9406 ● FA9433		
Braccio doppio 500mm. Per palo Ø 60mm.	Double bracket 500mm. For pole Ø 60mm.	● FA9606 ● FA9633		

Franco 3 Ø 76mm

Braccio singolo 180mm. Per palo Ø 76mm.	Single bracket 180mm. For pole Ø 76mm.	● FA11206 ● FA11233		
Braccio doppio 180mm. Per palo Ø 76mm.	Double bracket 180mm. For pole Ø 76mm.	● FA11406 ● FA11433		
Braccio singolo 500mm. Per palo Ø 76mm.	Single bracket 500mm. For pole Ø 76mm.	● FA11306 ● FA11333		
Braccio doppio 500mm. Per palo Ø 76mm.	Double bracket 500mm. For pole Ø 76mm.	● FA11506 ● FA11533		

Franco 3 Ø 102mm

Braccio singolo 180mm. Per palo Ø 102mm.	Single bracket 180mm. For pole Ø 102mm.	● FA7806 ● FA7833		
Braccio doppio 180mm. Per palo Ø 102mm.	Double bracket 180mm. For pole Ø 102mm.	● FA9006 ● FA9033		
Braccio singolo 500mm. Per palo Ø 102mm.	Single bracket 500mm. For pole Ø 102mm.	● FA7906 ● FA7933		
Braccio doppio 500mm. Per palo Ø 102mm.	Double bracket 500mm. For pole Ø 102mm.	● FA8906 ● FA8933		

Perseo





Perseo



Famiglia / Family

Perseo 1



Power Led

up to 7W
up to 373 lm - 2700K/CRI 80
up to 401 lm - 3000K/CRI 80
up to 427 lm - 4000K/CRI 80

Mid-Power Led

up to 9W
up to 435 lm - 2700K/CRI 80
up to 468 lm - 3000K/CRI 80
up to 491 lm - 4000K/CRI 80

Perseo 2



Power Led

up to 12W
up to 866 lm - 2700K/CRI 80
up to 963 lm - 3000K/CRI 80
up to 984 lm - 4000K/CRI 80

Mid-Power Led

up to 11W
up to 580 lm - 2700K/CRI 80
up to 624 lm - 3000K/CRI 80
up to 655 lm - 4000K/CRI 80

Perseo 3



Power Led

up to 20W
up to 1559 lm - 2700K/CRI 80
up to 1732 lm - 3000K/CRI 80
up to 1771 lm - 4000K/CRI 80

Perseo 4



Power Led

up to 48W
up to 3989 lm - 2700K/CRI 80
up to 4332 lm - 3000K/CRI 80
up to 4533 lm - 4000K/CRI 80

RGB - Power Led

up to 40W + 220-240V
DMX interface.

Colori / Colours



01 White



06 Grey



12 Forest Green

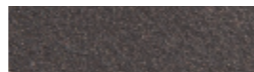

18 Deep Brown



30 Black



33 Anthracite

Descrizione / Description

Famiglia completa di apparecchi di illuminazione con sorgente luminosa a LED orientabili a proiezione, predisposti per installazione a parete, a palo come testapalo, a soffitto e a terra con picchetto da ordinare separatamente. Disponibile in quattro tagli dimensionali e in varie ottiche per dimensione, comprese ottiche stradali per applicazioni in contesto urbano. Corpo in alluminio pressofuso lega EN AB 47100 (a basso contenuto di rame) e riflettore in alluminio superpuro. Diffusore in vetro extrachiaro o sabbiato con bordo serigrafato fissato alla cornice attraverso un sistema di incollaggio robotizzato. Disponibile in differenti finiture con rivestimento a doppio strato di polveri e sottoposte a trattamento di conversione chimica superficiale per una elevata resistenza alla corrosione. Staffa di fissaggio in acciaio inox AISI 316L verniciata della stessa finitura del corpo apparecchio.

Perseo 1 / Perseo 2

Apparecchi orientabili a proiezione, predisposti per installazione a parete, a soffitto e a terra, disponibili in tre fasci di apertura: spot, medium (vetro trasparente) e diffuso (vetro sabbiato). L'apparecchio è dotato di uno spezzone di cavo uscente in neoprene e kit con connettori crimp e guaina termorestringente adesiva per connessione a tenuta stagna. La staffa di fissaggio in acciaio inox AISI 316L permette una orientabilità di 180° circa sull'asse verticale. Completano la gamma gli accessori opzionali picchetto per installazione a terra, paletti per installazione come bollard e bracci a parete dedicati per l'illuminazione in oggetto di insegne. Nei paletti e nei bracci sono inclusi i connettori IP68 per il cablaggio facile e sicuro.

Perseo 3 / Perseo 4

Apparecchi orientabili a proiezione, predisposti per installazione a parete, a palo come testapalo, a soffitto e a terra, disponibili in quattro fasci di apertura: spot, medium, asimmetrico e ottica stradale per inserimento in contesto urbano. L'apparecchio è dotato di un pressacavo in metallo. Per garantire la tenuta del pressacavo è consigliabile utilizzare cavi elettrici flessibili idonei all'impiego in ambienti esterni. La staffa di fissaggio in acciaio inox AISI 316L è graduata per garantire una regolazione precisa della unità emittente e una orientabilità di 150° circa sull'asse verticale. Completano la gamma gli accessori opzionali: paletti per installazione come bollard; bracci a parete dedicati per l'illuminazione in oggetto di insegne (nei paletti e nei bracci sono inclusi i connettori IP68 per il cablaggio facile e sicuro); una serie completa di pali cilindrici di diverso diametro ed altezza da interrare o con base di fissaggio e tirafondi; bracci singoli e doppi di due lunghezze per pali di differenti diametri; visiera wall-washer e ghiera anti-vandalo.

Disponibile per Perseo 4 la versione RGB per la creazione di scenografie luminose colorate.

Complete family of tiltable projection luminaires with LED source, designed for wall, post, ceiling and ground mounting with a metal nail that needs to be ordered separately. Available in four dimensions and with different light beams for every dimension, including optics for urban uses. Die cast aluminum body EN AB-47100 (with low copper content) and super pure aluminum reflector. Extraclear or frosted glass diffuser with silkscreen edge, attached to the frame with a robotic gluing system. Available in different finishes, with double-layered powder coating and chemical conversion surface treatment to ensure high corrosion resistance. AISI 316L stainless steel fixing bracket with the same finish as the luminaire body.

Perseo 1 / Perseo 2

Tiltable projection luminaires for wall, ceiling, and ground mounting. Three beam angles available: slim, medium (transparent glass) and diffused (frosted glass). Equipped with a protruding section of neoprene cable and a kit with crimpable connectors and adhesive heat-shrinkable sleeves that guarantee the tightness of the connection. The AISI 316L stainless steel fixing bracket allows for a tilting of approx. 180° on the vertical axis. The range is completed with the following optional accessories: ground spike; feet to install the luminaire as a bollard; and protruding arms for sign lighting. The feet and arms include IP68 connectors to guarantee an easy and safe cabling.

Perseo 3 / Perseo 4

Tiltable projection luminaires for wall, post, ceiling, and ground mounting. Four beam angles available: slim, medium, asymmetrical, and urban optics. Equipped with a metal cable guide. To ensure the tightness of the cable guide it's recommended to use flexible electric cables suitable for exterior use. AISI316L stainless steel fixing bracket, graduated to guarantee precision in the adjustment of the emission unit and a tilting of approx. 150° on the vertical axis. The range is completed with the following optional accessories: feet to install the luminaire as a bollard; arms for wall mounting, suitable for sign lighting at a distance (the feet and arms include IP68 connectors for an easy and safe cabling); a complete series of cylinder feet in different diameters and heights to be ground recessed or fixed with anchor plates and lag screws; single and double arms in two lengths for posts with different diameters, wall-washer visor and anti-vandalism protection lid. The Perseo 30 model is completed with the RGB version to create sceneries with colored light.

Perseo 1

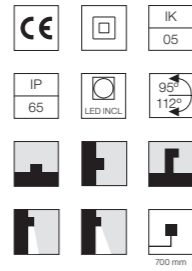
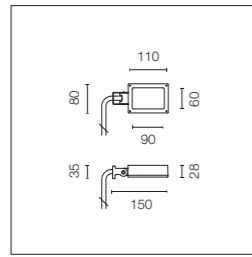

Sorgente a LED inclusa. Alimentazione elettrica 100-240V ON/OFF integrata. Staffa di fissaggio inclusa. Dotato di spezzone di cavo uscente in neoprene 700 mm e kit con connettori crimp e guaina termorestringente adesiva per connessione a tenuta stagna. Accessori opzionali: picchetto per installazione a terra; paletti per installazione a terra e bracci per installazione a parete (incluso connettore IP68). Vetro trasparente extrachiaro.

LED source included. Integrated electrical power supply 100-240V ON- OFF. Fixing bracket included. Equipped with a 700 mm protruding section of neoprene cable and a kit with crimpable connectors and adhesive heat-shrinkable sleeves that guarantee the tightness of the connection. Optional accessories: ground spike; feet for ground mounting and arms for wall mounting (IP68 connector included). Extraclear transparent glass.

Optic Narrow Spot 8°

Power Led: 7W - 398 lm ≠ OUTPUT 373 lm - 2700K/CRI 80 - 100-240V / 7 W - 428 lm ≠ OUTPUT 401 lm - 3000K/CRI 80 - 100-240V / 7 W - 456 lm ≠ OUTPUT 427 lm - 4000K/CRI 80 - 100-240V

- | | | |
|--------------|--------------|--------------|
| 2700K | 3000K | 4000K |
| ○ FA52514001 | ○ FA52501301 | ○ FA52501201 |
| ● FA52514006 | ● FA52501306 | ● FA52501206 |
| ● FA52514012 | ● FA52501312 | ● FA52501212 |
| ● FA52514018 | ● FA52501318 | ● FA52501218 |
| ● FA52514030 | ● FA52501330 | ● FA52501230 |
| ● FA52514033 | ● FA52501333 | ● FA52501233 |

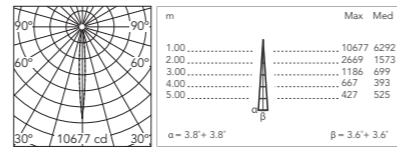

@ 4000K

Optic Medium 40°

Power Led: 7W - 398 lm ≠ OUTPUT 332 lm - 2700K/CRI 80 - 100-240V / 7W - 428 lm ≠ OUTPUT 357 lm - 3000K/CRI 80 - 100-240V / 7W - 456 lm ≠ OUTPUT 381 lm - 4000K/CRI 80 - 100-240V

- | | | |
|--------------|--------------|--------------|
| 2700K | 3000K | 4000K |
| ○ FA52514201 | ○ FA52502301 | ○ FA52502201 |
| ● FA52514206 | ● FA52502306 | ● FA52502206 |
| ● FA52514212 | ● FA52502312 | ● FA52502212 |
| ● FA52514218 | ● FA52502318 | ● FA52502218 |
| ● FA52514230 | ● FA52502330 | ● FA52502230 |
| ● FA52514233 | ● FA52502333 | ● FA52502233 |

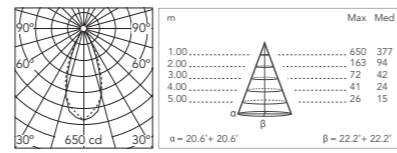

@ 4000K

Perseo 1 Opal

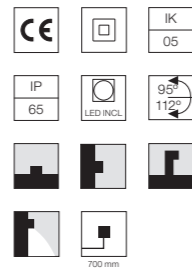
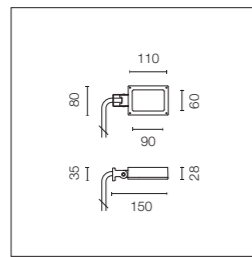

Sorgente a LED inclusa. Alimentazione elettrica 100-240V ON/OFF integrata. Staffa di fissaggio inclusa. Dotato di spezzone di cavo uscente in neoprene 700 mm e kit con connettori crimp e guaina termorestringente adesiva per connessione a tenuta stagna. Accessori opzionali: picchetto per installazione a terra; paletti per installazione a terra e bracci per installazione a parete (incluso connettore IP68). Vetro sabbato.

LED source included. Integrated electrical power supply 100-240V ON- OFF. Fixing bracket included. Equipped with a 700 mm protruding section of neoprene cable and a kit with crimpable connectors and adhesive heat-shrinkable sleeves that guarantee the tightness of the connection. Optional accessories: ground spike; feet for ground mounting and arms for wall mounting (IP68 connector included). Frosted glass.

Diffused Light

Mid-Power Led: 9W - 836 lm ≠ OUTPUT 435 lm - 2700K/CRI 80 - 100-240V / 9 W - 899 lm ≠ OUTPUT 468 lm - 3000K/CRI 80 - 100-240V / 9 W - 943 lm ≠ OUTPUT 491 lm - 4000K/CRI 80 - 100-240V

- | | | |
|--------------|--------------|--------------|
| 2700K | 3000K | 4000K |
| ○ FA52514401 | ○ FA52500301 | ○ FA52500201 |
| ● FA52514406 | ● FA52500306 | ● FA52500206 |
| ● FA52514412 | ● FA52500312 | ● FA52500212 |
| ● FA52514418 | ● FA52500318 | ● FA52500218 |
| ● FA52514430 | ● FA52500330 | ● FA52500230 |
| ● FA52514433 | ● FA52500333 | ● FA52500233 |

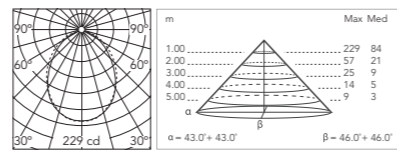

@ 4000K

Perseo 1: Accessori / Accessories

Picchetto per installazione a terra.

Ground spike.

FA136

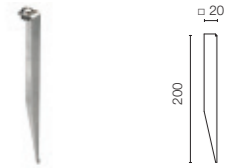

Braccio / Palo 300mm.

Wall bracket / Pole 300mm.

- FA15701
- FA15706
- FA15712
- FA15718
- FA15730
- FA15733



Braccio / Palo 600mm.

Wall bracket / Pole 600mm.

- FA15801
- FA15806
- FA15812
- FA15818
- FA15830
- FA15833

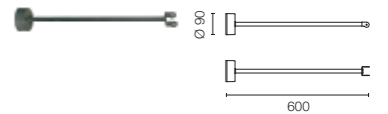

Dispositivo di protezione per il sovraccarico. 275Vac. Corrente massima di scarica 10KA (8/29µs). Massima corrente operativa 5A. Adatto per la connessione in serie. IP66.

Surge protection device. 275Vac. Maximum discharge current 10KA (8/20µs). Maximum operating current 5A. Suitable for series connection. IP66.

F990E00A000

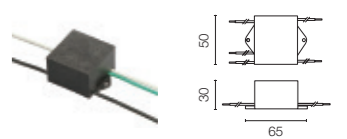

Installation scheme: Perseo 1

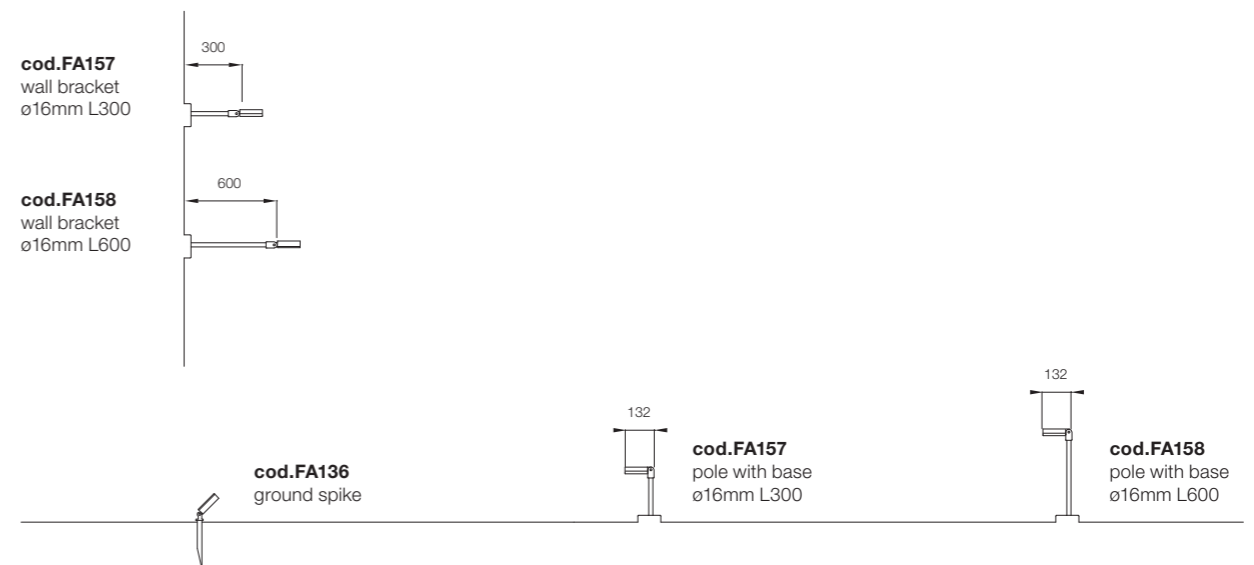

Perseo 2

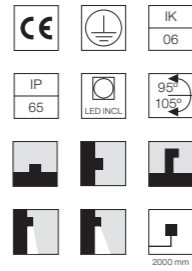
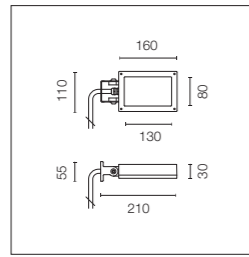

Sorgente a LED inclusa. Alimentazione elettrica 220-240V ON/OFF integrata. Staffa di fissaggio inclusa. Dotato di spezzone di cavo uscente in neoprene 700 mm e kit con connettori crimp e guaina termorestringente adesiva per connessione a tenuta stagna. Accessori opzionali: picchetto per installazione a terra; paletti per installazione a terra e bracci per installazione a parete (incluso connettore IP68). Vetro trasparente extrachiario.

LED source included. Integrated electrical power supply 220-240V ON- OFF. Fixing bracket included. Equipped with a 700 mm protruding section of neoprene cable and a kit with crimpable connectors and adhesive heat-shrinkable sleeves that guarantee the tightness of the connection. Optional accessories: ground spike; feet for ground mounting and arms for wall mounting (IP68 connector included). Extraclear transparent glass.

Optic Spot 13°

Power Led: 12W - 1256 lm ≠ OUTPUT 866 lm - 2700K/CRI 80 - 220-240V / 2W - 1395 lm ≠ OUTPUT 963 lm - 3000K/CRI 80 - 220-240V / 2W - 1465 lm ≠ OUTPUT 984 lm - 4000K/CRI 80 - 220-240V

- | | | |
|--------------|--------------|--------------|
| 2700K | 3000K | 4000K |
| ○ FA52514601 | ○ FA52504301 | ○ FA52504201 |
| ● FA52514606 | ● FA52504306 | ● FA52504206 |
| ● FA52514612 | ● FA52504312 | ● FA52504212 |
| ● FA52514618 | ● FA52504318 | ● FA52504218 |
| ● FA52514630 | ● FA52504330 | ● FA52504230 |
| ● FA52514633 | ● FA52504333 | ● FA52504233 |

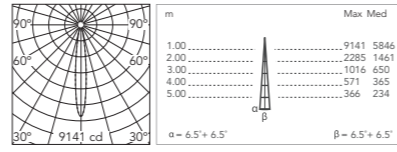

@ 4000K

Optic Medium 42°

Power Led: 12W - 1256 lm ≠ OUTPUT 745 lm - 2700K/CRI 80 - 220-240V / 12W - 1395 lm ≠ OUTPUT 828 lm - 3000K/CRI 80 - 220-240V / 2W - 1465 lm ≠ OUTPUT 846 lm - 4000K/CRI 80 - 220-240V

- | | | |
|--------------|--------------|--------------|
| 2700K | 3000K | 4000K |
| ○ FA52514801 | ○ FA52505301 | ○ FA52505201 |
| ● FA52514806 | ● FA52505306 | ● FA52505206 |
| ● FA52514812 | ● FA52505312 | ● FA52505212 |
| ● FA52514818 | ● FA52505318 | ● FA52505218 |
| ● FA52514830 | ● FA52505330 | ● FA52505230 |
| ● FA52514833 | ● FA52505333 | ● FA52505233 |

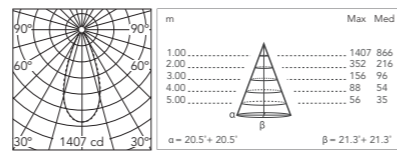

@ 4000K

Perseo 2 Opal

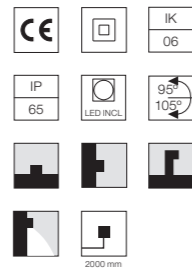
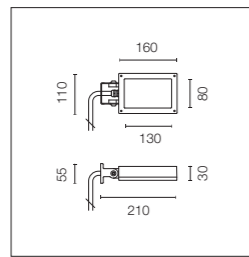

Sorgente a LED inclusa. Alimentazione elettrica 220-240V ON/OFF integrata. Staffa di fissaggio inclusa. Dotato di spezzone di cavo uscente in neoprene 700 mm e kit con connettori crimp e guaina termorestringente adesiva per connessione a tenuta stagna. Accessori opzionali: picchetto per installazione a terra; paletti per installazione a terra e bracci per installazione a parete (incluso connettore IP68). Vetro sabbato.

LED source included. Integrated electrical power supply 220-240V ON- OFF. Fixing bracket included. Equipped with a 700 mm protruding section of neoprene cable and a kit with crimpable connectors and adhesive heat-shrinkable sleeves that guarantee the tightness of the connection. Optional accessories: ground spike; feet for ground mounting and arms for wall mounting (IP68 connector included). Frosted glass.

Diffused Light

Mid-Power Led: 11W - 1114 lm ≠ OUTPUT 580 lm - 2700K/CRI 80 - 220-240V / 1W - 1198 lm ≠ OUTPUT 624 lm - 3000K/CRI 80 - 220-240V / 1W - 1258 lm ≠ OUTPUT 655 lm - 4000K/CRI 80 - 220-240V

- | | | |
|--------------|--------------|--------------|
| 2700K | 3000K | 4000K |
| ○ FA52515001 | ○ FA52503301 | ○ FA52503201 |
| ● FA52515006 | ● FA52503306 | ● FA52503206 |
| ● FA52515012 | ● FA52503312 | ● FA52503212 |
| ● FA52515018 | ● FA52503318 | ● FA52503218 |
| ● FA52515030 | ● FA52503330 | ● FA52503230 |
| ● FA52515033 | ● FA52503333 | ● FA52503233 |

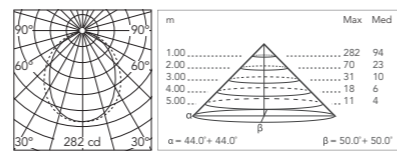

@ 4000K

Perseo 2 / Ø 48mm - Poles With Base



H 500mm

- FA17701
- FA17706
- FA17712
- FA17718
- FA17730
- FA17733

H 800mm

- FA17801
- FA17806
- FA17812
- FA17818
- FA17830
- FA17833

Perseo 2: Accessori / Accessories

Picchetto per installazione a terra.

Ground spike.

FA136

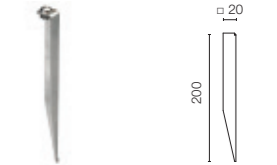

Braccio / Palo 300mm.

Wall bracket / Pole 300mm.

- FA16101
- FA16106
- FA16112
- FA16118
- FA16130
- FA16133



Braccio / Palo 600mm.

Wall bracket / Pole 600mm.

- FA16201
- FA16206
- FA16212
- FA16218
- FA16230
- FA16233



Piastra tirafondi.

Base plate with bolt.

FA182



Dispositivo di protezione per il sovraccarico. 275Vac. Corrente massima di scarica 10KA (8/29µs). Massima corrente operativa 5A. Adatto per la connessione in serie. IP66.

Surge protection device. 275Vac. Maximum discharge current 10KA (8/20µs). Maximum operating current 5A. Suitable for series connection. IP66.

F990E00A000

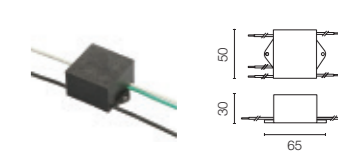

Installation scheme: Perseo 2

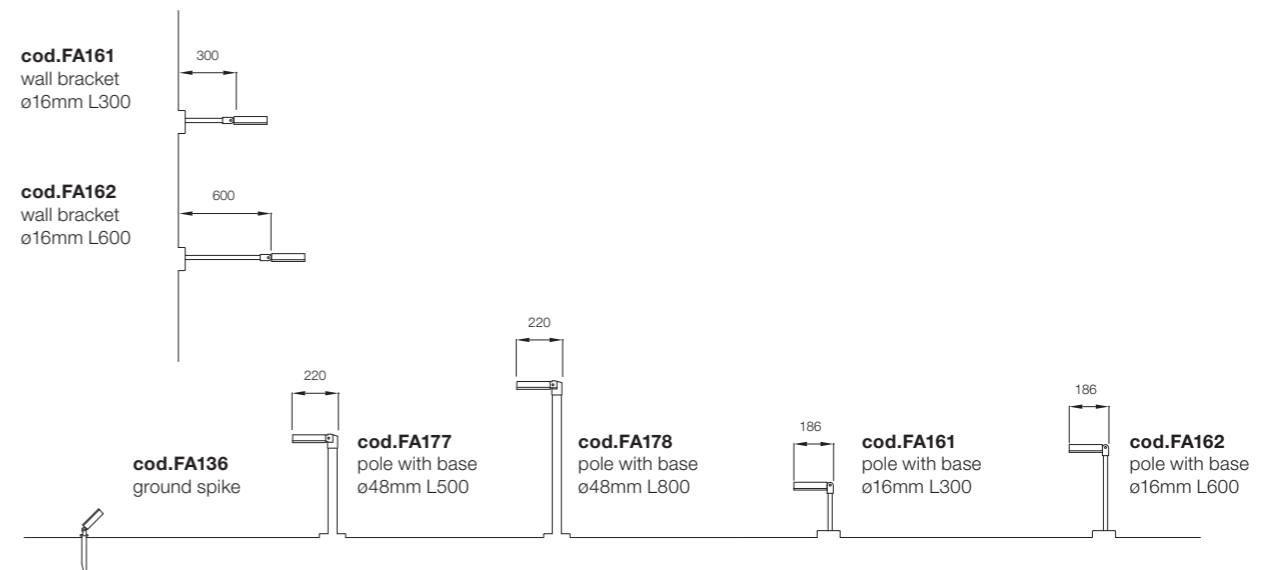

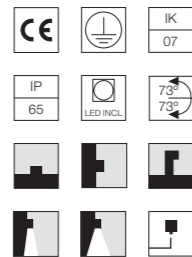
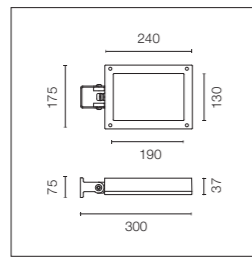

Sorgente a LED inclusa. Alimentazione elettrica 220-240V ON/OFF e dimmerabile 1-10V o DALI integrata. Staffa di fissaggio inclusa. Dotato di pressacavo in metallo M16x1,5 (per cavi 4,5mmϕ<math><10\text{mm}</math>). Per garantire la tenuta del pressacavo è consigliabile utilizzare cavi elettrici flessibili idonei all'impiego in ambienti esterni. Accessori opzionali: braccio in oggetto a parete; paletti; pali e relativi bracci per installazione come testapalo; visiera wall-washer e ghiera anti-vandalo. Vetro trasparente extrachiaro.

LED source included. Integrated power supply 220-240V ON/OFF and dimmable 1-10V or DALI. Fixing bracket included. Equipped with a M16x1.5 cable guide (for 4.5mmϕ<math><10\text{mm}</math> cables) and IP68 connector. To ensure the tightness of the cable guide it's recommended to use flexible electric cables suitable for exterior use. Optional accessories: protruding arm for walls; feet and arms to install the luminaire on a mast; wall-washer visor and anti-vandalism protection lid. Extraclear transparent glass.

Optic Spot 11°

Power Led: 20W - 2232 lm \neq OUTPUT 1559 lm - 2700K/CRI 80 - 220-240V / 20W - 2424 lm \neq OUTPUT 1732 lm - 3000K/CRI 80 - 220-240V / 20W - 2536 lm \neq OUTPUT 1771 lm - 4000K/CRI 80 - 220-240V

- | | | |
|------------------------------|------------------------------|------------------------------|
| 2700K
Non Dimmable | 3000K
Non Dimmable | 4000K
Non Dimmable |
| ○ FA52515201 | ○ FA52509301 | ○ FA52509201 |
| ● FA52515206 | ● FA52509306 | ● FA52509206 |
| ● FA52515212 | ● FA52509312 | ● FA52509212 |
| ● FA52515218 | ● FA52509318 | ● FA52509218 |
| ● FA52515230 | ● FA52509330 | ● FA52509230 |
| ● FA52515233 | ● FA52509333 | ● FA52509233 |
| 1-10V | 1-10V | 1-10V |
| ○ FA52515201-310 | ○ FA52509301-310 | ○ FA52509201-310 |
| ● FA52515206-310 | ● FA52509306-310 | ● FA52509206-310 |
| ● FA52515212-310 | ● FA52509312-310 | ● FA52509212-310 |
| ● FA52515218-310 | ● FA52509318-310 | ● FA52509218-310 |
| ● FA52515230-310 | ● FA52509330-310 | ● FA52509230-310 |
| ● FA52515233-310 | ● FA52509333-310 | ● FA52509233-310 |
| Dali | Dali | Dali |
| ○ FA52515201-300 | ○ FA52509301-300 | ○ FA52509201-300 |
| ● FA52515206-300 | ● FA52509306-300 | ● FA52509206-300 |
| ● FA52515212-300 | ● FA52509312-300 | ● FA52509212-300 |
| ● FA52515218-300 | ● FA52509318-300 | ● FA52509218-300 |
| ● FA52515230-300 | ● FA52509330-300 | ● FA52509230-300 |
| ● FA52515233-300 | ● FA52509333-300 | ● FA52509233-300 |

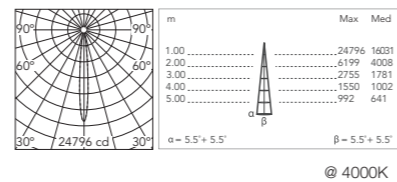

Optic Medium 34°

Power Led: 20W - 2232 lm \neq OUTPUT 1582 lm - 2700K/CRI 80 - 220-240V / 20W - 2424 lm \neq OUTPUT 1757 lm - 3000K/CRI 80 - 220-240V / 20W - 2536 lm \neq OUTPUT 1797 lm - 4000K/CRI 80 - 220-240V

- | | | |
|------------------------------|------------------------------|------------------------------|
| 2700K
Non Dimmable | 3000K
Non Dimmable | 4000K
Non Dimmable |
| ○ FA52515401 | ○ FA52508301 | ○ FA52508201 |
| ● FA52515406 | ● FA52508306 | ● FA52508206 |
| ● FA52515412 | ● FA52508312 | ● FA52508212 |
| ● FA52515418 | ● FA52508318 | ● FA52508218 |
| ● FA52515430 | ● FA52508330 | ● FA52508230 |
| ● FA52515433 | ● FA52508333 | ● FA52508233 |
| 1-10V | 1-10V | 1-10V |
| ○ FA52515401-310 | ○ FA52508301-310 | ○ FA52508201-310 |
| ● FA52515406-310 | ● FA52508306-310 | ● FA52508206-310 |
| ● FA52515412-310 | ● FA52508312-310 | ● FA52508212-310 |
| ● FA52515418-310 | ● FA52508318-310 | ● FA52508218-310 |
| ● FA52515430-310 | ● FA52508330-310 | ● FA52508230-310 |
| ● FA52515433-310 | ● FA52508333-310 | ● FA52508233-310 |
| Dali | Dali | Dali |
| ○ FA52515401-300 | ○ FA52508301-300 | ○ FA52508201-300 |
| ● FA52515406-300 | ● FA52508306-300 | ● FA52508206-300 |
| ● FA52515412-300 | ● FA52508312-300 | ● FA52508212-300 |
| ● FA52515418-300 | ● FA52508318-300 | ● FA52508218-300 |
| ● FA52515430-300 | ● FA52508330-300 | ● FA52508230-300 |
| ● FA52515433-300 | ● FA52508333-300 | ● FA52508233-300 |

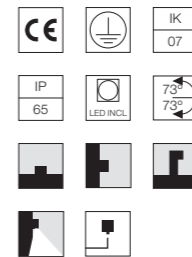
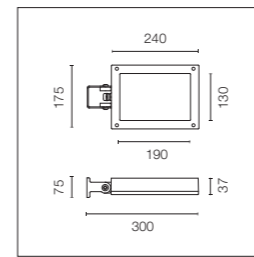
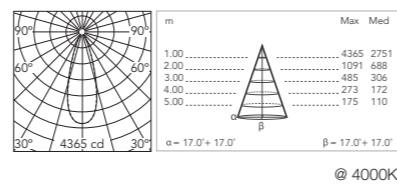

Sorgente a LED inclusa. Alimentazione elettrica 220-240V ON/OFF e dimmerabile 1-10V o DALI integrata. Staffa di fissaggio inclusa. Dotato di pressacavo in metallo M16x1,5 (per cavi 4,5mmϕ<math><10\text{mm}</math>). Per garantire la tenuta del pressacavo è consigliabile utilizzare cavi elettrici flessibili idonei all'impiego in ambienti esterni. Accessori opzionali: braccio in oggetto a parete; paletti; pali e relativi bracci per installazione come testapalo; visiera wall-washer e ghiera anti-vandalo.

LED source included. Integrated power supply 220-240V ON/OFF and dimmable 1-10V or DALI. Fixing bracket included. Equipped with a M16x1.5 cable guide (for 4.5mmϕ<math><10\text{mm}</math> cables) and IP68 connector. To ensure the tightness of the cable guide it's recommended to use flexible electric cables suitable for exterior use. Optional accessories: protruding arm for walls; feet and arms to install the luminaire on a mast; wall-washer visor and anti-vandalism protection lid. Extraclear transparent glass.

Asymmetric Optic

Power Led: 20W - 2232 lm \neq OUTPUT 1168 lm - 2700K/CRI 80 - 220-240V / 20W - 2424 lm \neq OUTPUT 1298 lm - 3000K/CRI 80 - 220-240V / 20W - 2536 lm \neq OUTPUT 1327 lm - 4000K/CRI 80 - 220-240V

- | | | |
|------------------------------|------------------------------|------------------------------|
| 2700K
Non Dimmable | 3000K
Non Dimmable | 4000K
Non Dimmable |
| ○ FA52515601 | ○ FA52506301 | ○ FA52506201 |
| ● FA52515606 | ● FA52506306 | ● FA52506206 |
| ● FA52515612 | ● FA52506312 | ● FA52506212 |
| ● FA52515618 | ● FA52506318 | ● FA52506218 |
| ● FA52515630 | ● FA52506330 | ● FA52506230 |
| ● FA52515633 | ● FA52506333 | ● FA52506233 |
| 1-10V | 1-10V | 1-10V |
| ○ FA52515601-310 | ○ FA52506301-310 | ○ FA52506201-310 |
| ● FA52515606-310 | ● FA52506306-310 | ● FA52506206-310 |
| ● FA52515612-310 | ● FA52506312-310 | ● FA52506212-310 |
| ● FA52515618-310 | ● FA52506318-310 | ● FA52506218-310 |
| ● FA52515630-310 | ● FA52506330-310 | ● FA52506230-310 |
| ● FA52515633-310 | ● FA52506333-310 | ● FA52506233-310 |
| Dali | Dali | Dali |
| ○ FA52515601-300 | ○ FA52506301-300 | ○ FA52506201-300 |
| ● FA52515606-300 | ● FA52506306-300 | ● FA52506206-300 |
| ● FA52515612-300 | ● FA52506312-300 | ● FA52506212-300 |
| ● FA52515618-300 | ● FA52506318-300 | ● FA52506218-300 |
| ● FA52515630-300 | ● FA52506330-300 | ● FA52506230-300 |
| ● FA52515633-300 | ● FA52506333-300 | ● FA52506233-300 |

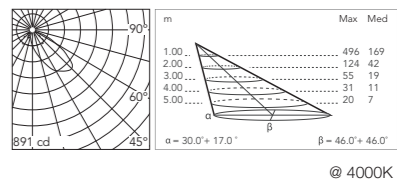

Street Light 120°

Power Led: 20W - 2232 lm \neq OUTPUT 972 lm - 2700K/CRI 80 - 220-240V / 20W - 2424 lm \neq OUTPUT 1080 lm - 3000K/CRI 80 - 220-240V / 20W - 2536 lm \neq OUTPUT 1105 lm - 4000K/CRI 80 - 220-240V

- | | | |
|------------------------------|------------------------------|------------------------------|
| 2700K
Non Dimmable | 3000K
Non Dimmable | 4000K
Non Dimmable |
| ○ FA52515801 | ○ FA52507301 | ○ FA52507201 |
| ● FA52515806 | ● FA52507306 | ● FA52507206 |
| ● FA52515812 | ● FA52507312 | ● FA52507212 |
| ● FA52515818 | ● FA52507318 | ● FA52507218 |
| ● FA52515830 | ● FA52507330 | ● FA52507230 |
| ● FA52515833 | ● FA52507333 | ● FA52507233 |
| 1-10V | 1-10V | 1-10V |
| ○ FA52515801-310 | ○ FA52507301-310 | ○ FA52507201-310 |
| ● FA52515806-310 | ● FA52507306-310 | ● FA52507206-310 |
| ● FA52515812-310 | ● FA52507312-310 | ● FA52507212-310 |
| ● FA52515818-310 | ● FA52507318-310 | ● FA52507218-310 |
| ● FA52515830-310 | ● FA52507330-310 | ● FA52507230-310 |
| ● FA52515833-310 | ● FA52507333-310 | ● FA52507233-310 |
| Dali | Dali | Dali |
| ○ FA52515801-300 | ○ FA52507301-300 | ○ FA52507201-300 |
| ● FA52515806-300 | ● FA52507306-300 | ● FA52507206-300 |
| ● FA52515812-300 | ● FA52507312-300 | ● FA52507212-300 |
| ● FA52515818-300 | ● FA52507318-300 | ● FA52507218-300 |
| ● FA52515830-300 | ● FA52507330-300 | ● FA52507230-300 |
| ● FA52515833-300 | ● FA52507333-300 | ● FA52507233-300 |

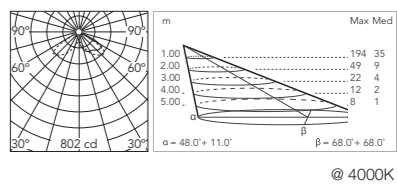

Perseso 3 LED / Ø 48mm - Poles

Con Base / With Base



H 800mm

- FA17901
- FA17906
- FA17912
- FA17918
- FA17930
- FA17933

Da Interrare (+300 mm Interrati)

In-Ground (+300 mm Root)



H 2000mm

- FA18001
- FA18006
- FA18012
- FA18018
- FA18030
- FA18033

Perseso 3 LED / Ø 76mm - Poles

Con Base e Portella con Morsettiera.

With Base and Access Door.
With Terminal Block 4x1,5-16mmq.



H 3500mm

- FA24806
- FA24833

H 4500mm

- FA24906
- FA24933

Da Interrare (+500 mm Interrati) e Portella con Morsettiera

In-Ground (+500 mm Root) With Access Door
With Terminal Block 4x1,5-16mmq



H 3500mm

- FA25006
- FA25033

H 4500mm

- FA25106
- FA25133

Perseso 3 LED / Ø 102mm - Poles

Con Base e Portella con Morsettiera.

With Base and Access Door .
With Terminal Block 4x1,5-16mmq.



H 4000mm

- FA414006
- FA414033

H 5000mm

- FA415006
- FA415033

Da Interrare (+500 mm Interrati) e Portella con Morsettiera

In-Ground (+500 mm Root) With Access Door
With Terminal Block 4x1,5-16mmq



H 4000mm

- FA414506
- FA414533

H 5000mm

- FA415506
- FA415533

Installation scheme: Perseso 3

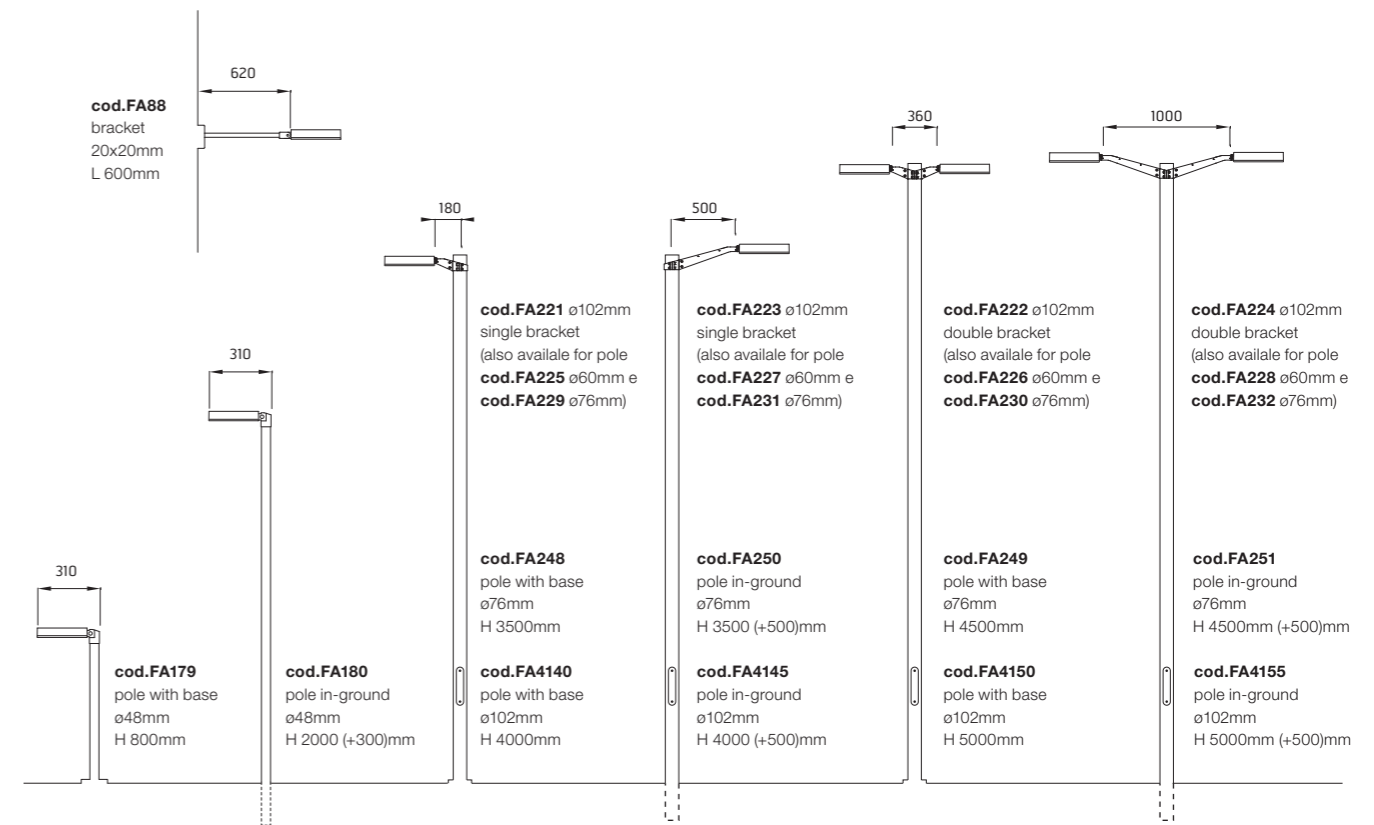

Perseo 3: Accessori / Accessories

Visiera Wall-Washer

Wall Washer Visor

FA16530

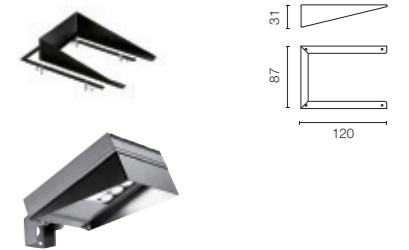





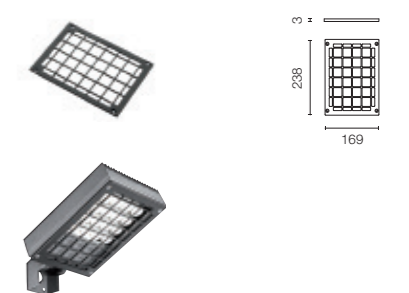

Ghiera anti vandali

Anti vandal louvre

FA16630

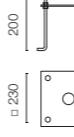



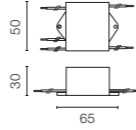



Perseo 3: Accessori / Accessories

Piastra tirafondi.	Base plate with bolt.	H: 500 / 800mm FA182	 
Piastra tirafondi.	Base plate with bolt.	H: 3500 / 4500mm with base FA116	 
Braccio 620mm.	Wall bracket 620mm.	○ FA8801 ● FA8806 ● FA8812 ● FA8818 ● FA8830 ● FA8833	 
Dispositivo di protezione per il sovraccarico. 275Vac. Corrente massima di scarica 10KA (8/29µs). Massima corrente operativa 5A. Adatto per la connessione in serie. IP66.	Surge protection device. 275Vac. Maximum discharge current 10KA (8/20µs). Maximum operating current 5A. Suitable for series connection. IP66.	F990E00A000	 

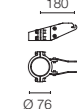
Perseo 3 Ø 60mm

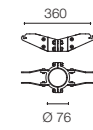
Braccio singolo 180mm. Per palo Ø 60mm.	Single bracket 180mm. For pole Ø 60mm.	● FA22506 ● FA22533	 
Braccio doppio 180mm. Per palo Ø 60mm.	Double bracket 180mm. For pole Ø 60mm.	● FA22606 ● FA22633	 
Braccio singolo 500mm. Per palo Ø 60mm.	Single bracket 500mm. For pole Ø 60mm.	● FA22706 ● FA22733	 
Braccio doppio 500mm. Per palo Ø 60mm.	Double bracket 500mm. For pole Ø 60mm.	● FA22806 ● FA22833	 

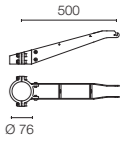
Perseo 3 Ø 76mm

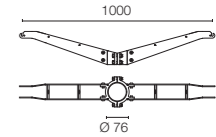
Braccio singolo 180mm. Per palo Ø 76mm.	Single bracket 180mm. For pole Ø 76mm.	● FA22906 ● FA22933	 
Braccio doppio 180mm. Per palo Ø 76mm.	Double bracket 180mm. For pole Ø 76mm.	● FA23006 ● FA23033	 
Braccio singolo 500mm. Per palo Ø 76mm.	Single bracket 500mm. For pole Ø 76mm.	● FA23106 ● FA23133	 
Braccio doppio 500mm. Per palo Ø 76mm.	Double bracket 500mm. For pole Ø 76mm.	● FA23206 ● FA23233	 

Perseo 3 Ø 102mm

Braccio singolo 180mm. Per palo Ø 102mm.	Single bracket 180mm. For pole Ø 102mm.	● FA22106 ● FA22133	 
Braccio doppio 180mm. Per palo Ø 102mm.	Double bracket 180mm. For pole Ø 102mm.	● FA22206 ● FA22233	 
Braccio singolo 500mm. Per palo Ø 102mm.	Single bracket 500mm. For pole Ø 102mm.	● FA22306 ● FA22333	 
Braccio doppio 500mm. Per palo Ø 102mm.	Double bracket 500mm. For pole Ø 102mm.	● FA22406 ● FA22433	 

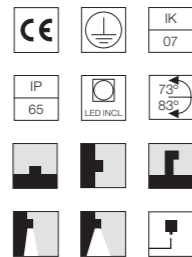
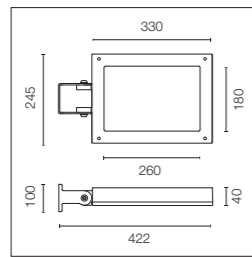

Sorgente a LED inclusa. Alimentazione elettrica 220-240V ON/OFF e dimmerabile 1-10V o DALI integrata. Staffa di fissaggio graduata inclusa. Dotato di pressacavo in metallo M20x1,5 (per cavi 7mmϕ<math><13\text{mm}</math>). Per garantire la tenuta del pressacavo è consigliabile utilizzare cavi elettrici flessibili idonei all'impiego in ambienti esterni. Accessori opzionali: braccio in oggetto a parete; pali e relativi bracci per installazione come testapalo; visiera wall-washer e ghiera anti-vandalo. Vetro trasparente extrachiaro.

LED source included. Integrated power supply 220-240V ON-OFF and dimmable 1-10V or DALI. Graduated fixing bracket included. Equipped with a M20x1.5 cable guide (for 7mmϕ<math><13\text{mm}</math> cables) and IP68 connector. To ensure the tightness of the cable guide it's recommended to use flexible electric cables suitable for exterior use. Optional accessories: protruding arm for walls; feet and arms to install the luminaire on a mast; wall-washer visor and anti-vandalism protection lid. Extraclear transparent glass.

Optic Spot 11°

Power Led: 48W - 5859 lm \neq OUTPUT 3989 lm - 2700K/CRI 80 - 220-240V / 48W - 6363 lm \neq OUTPUT 4332 lm - 3000K/CRI 80 - 220-240V / 48W - 6657 lm \neq OUTPUT 4533 lm - 4000K/CRI 80 - 220-240V

- | | | |
|--|--|--|
| 2700K
Non Dimmable | 3000K
Non Dimmable | 4000K
Non Dimmable |
| ○ FA52516001
● FA52516006
● FA52516012
● FA52516018
● FA52516030
● FA52516033 | ○ FA52513301
● FA52513306
● FA52513312
● FA52513318
● FA52513330
● FA52513333 | ○ FA52513201
● FA52513206
● FA52513212
● FA52513218
● FA52513230
● FA52513233 |
| 1-10V | 1-10V | 1-10V |
| ○ FA52516001-310
● FA52516006-310
● FA52516012-310
● FA52516018-310
● FA52516030-310
● FA52516033-310 | ○ FA52513301-310
● FA52513306-310
● FA52513312-310
● FA52513318-310
● FA52513330-310
● FA52513333-310 | ○ FA52513201-310
● FA52513206-310
● FA52513212-310
● FA52513218-310
● FA52513230-310
● FA52513233-310 |
| Dali | Dali | Dali |
| ○ FA52516001-300
● FA52516006-300
● FA52516012-300
● FA52516018-300
● FA52516030-300
● FA52516033-300 | ○ FA52513301-300
● FA52513306-300
● FA52513312-300
● FA52513318-300
● FA52513330-300
● FA52513333-300 | ○ FA52513201-300
● FA52513206-300
● FA52513212-300
● FA52513218-300
● FA52513230-300
● FA52513233-300 |

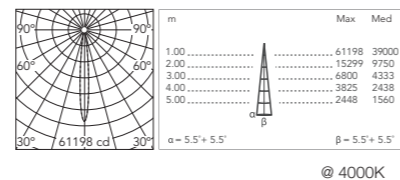

Optic Medium 34°

Power Led: 48W - 5859 lm \neq OUTPUT 4056 lm - 2700K/CRI 80 - 220-240V / 48W - 6363 lm \neq OUTPUT 4405 lm - 3000K/CRI 80 - 220-240V / 48W - 6657 lm \neq OUTPUT 4609 lm - 4000K/CRI 80 - 220-240V

- | | | |
|--|--|--|
| 2700K
Non Dimmable | 3000K
Non Dimmable | 4000K
Non Dimmable |
| ○ FA52516201
● FA52516206
● FA52516212
● FA52516218
● FA52516230
● FA52516233 | ○ FA52512301
● FA52512306
● FA52512312
● FA52512318
● FA52512330
● FA52512333 | ○ FA52512201
● FA52512206
● FA52512212
● FA52512218
● FA52512230
● FA52512233 |
| 1-10V | 1-10V | 1-10V |
| ○ FA52516201-310
● FA52516206-310
● FA52516212-310
● FA52516218-310
● FA52516230-310
● FA52516233-310 | ○ FA52512301-310
● FA52512306-310
● FA52512312-310
● FA52512318-310
● FA52512330-310
● FA52512333-310 | ○ FA52512201-310
● FA52512206-310
● FA52512212-310
● FA52512218-310
● FA52512230-310
● FA52512233-310 |
| Dali | Dali | Dali |
| ○ FA52516201-300
● FA52516206-300
● FA52516212-300
● FA52516218-300
● FA52516230-300
● FA52516233-300 | ○ FA52512301-300
● FA52512306-300
● FA52512312-300
● FA52512318-300
● FA52512330-300
● FA52512333-300 | ○ FA52512201-300
● FA52512206-300
● FA52512212-300
● FA52512218-300
● FA52512230-300
● FA52512233-300 |

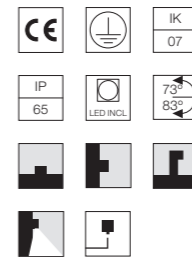
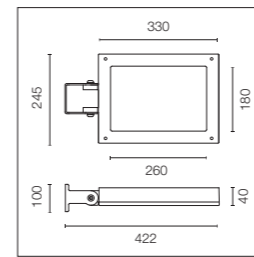
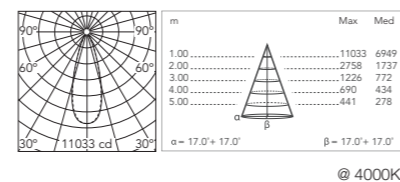

Sorgente a LED inclusa. Alimentazione elettrica 220-240V ON/OFF e dimmerabile 1-10V o DALI integrata. Staffa di fissaggio graduata inclusa. Dotato di pressacavo in metallo M20x1,5 (per cavi 7mmϕ<math><13\text{mm}</math>). Per garantire la tenuta del pressacavo è consigliabile utilizzare cavi elettrici flessibili idonei all'impiego in ambienti esterni. Accessori opzionali: braccio in oggetto a parete; pali e relativi bracci per installazione come testapalo; visiera wall-washer e ghiera anti-vandalo. Vetro trasparente extrachiaro.

LED source included. Integrated power supply 220-240V ON-OFF and dimmable 1-10V or DALI. Graduated fixing bracket included. Equipped with a M20x1.5 cable guide (for 7mmϕ<math><13\text{mm}</math> cables) and IP68 connector. To ensure the tightness of the cable guide it's recommended to use flexible electric cables suitable for exterior use. Optional accessories: protruding arm for walls; feet and arms to install the luminaire on a mast; wall-washer visor and anti-vandalism protection lid. Extraclear transparent glass.

Asymmetric Optic

Power Led: 53W - 5859 lm \neq OUTPUT 3085 lm - 2700K/CRI 80 - 220-240V / 53W - 6363 lm \neq OUTPUT 3350 lm - 3000K/CRI 80 - 220-240V / 53W - 6657 lm \neq OUTPUT 3505 lm - 4000K/CRI 80 - 220-240V

- | | | |
|--|--|--|
| 2700K
Non Dimmable | 3000K
Non Dimmable | 4000K
Non Dimmable |
| ○ FA52516401
● FA52516406
● FA52516412
● FA52516418
● FA52516430
● FA52516433 | ○ FA52510301
● FA52510306
● FA52510312
● FA52510318
● FA52510330
● FA52510333 | ○ FA52510201
● FA52510206
● FA52510212
● FA52510218
● FA52510230
● FA52510233 |
| 1-10V | 1-10V | 1-10V |
| ○ FA52516401-310
● FA52516406-310
● FA52516412-310
● FA52516418-310
● FA52516430-310
● FA52516433-310 | ○ FA52510301-310
● FA52510306-310
● FA52510312-310
● FA52510318-310
● FA52510330-310
● FA52510333-310 | ○ FA52510201-310
● FA52510206-310
● FA52510212-310
● FA52510218-310
● FA52510230-310
● FA52510233-310 |
| Dali | Dali | Dali |
| ○ FA52516401-300
● FA52516406-300
● FA52516412-300
● FA52516418-300
● FA52516430-300
● FA52516433-300 | ○ FA52510301-300
● FA52510306-300
● FA52510312-300
● FA52510318-300
● FA52510330-300
● FA52510333-300 | ○ FA52510201-300
● FA52510206-300
● FA52510212-300
● FA52510218-300
● FA52510230-300
● FA52510233-300 |

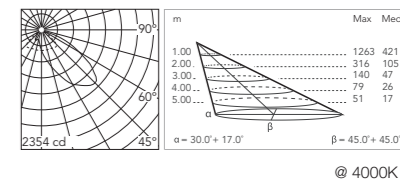

Street Light 120°

Power Led: 53W - 5859 lm \neq OUTPUT 2609 lm - 2700K/CRI 80 - 220-240V / 53W - 6363 lm \neq OUTPUT 2834 lm - 3000K/CRI 80 - 220-240V / 53W - 6657 lm \neq OUTPUT 2965 lm - 4000K/CRI 80 - 220-240V

- | | | |
|--|--|--|
| 2700K
Non Dimmable | 3000K
Non Dimmable | 4000K
Non Dimmable |
| ○ FA52516601
● FA52516606
● FA52516612
● FA52516618
● FA52516630
● FA52516633 | ○ FA52511301
● FA52511306
● FA52511312
● FA52511318
● FA52511330
● FA52511333 | ○ FA52511201
● FA52511206
● FA52511212
● FA52511218
● FA52511230
● FA52511233 |
| 1-10V | 1-10V | 1-10V |
| ○ FA52516601-310
● FA52516606-310
● FA52516612-310
● FA52516618-310
● FA52516630-310
● FA52516633-310 | ○ FA52511301-310
● FA52511306-310
● FA52511312-310
● FA52511318-310
● FA52511330-310
● FA52511333-310 | ○ FA52511201-310
● FA52511206-310
● FA52511212-310
● FA52511218-310
● FA52511230-310
● FA52511233-310 |
| Dali | Dali | Dali |
| ○ FA52516601-300
● FA52516606-300
● FA52516612-300
● FA52516618-300
● FA52516630-300
● FA52516633-300 | ○ FA52511301-300
● FA52511306-300
● FA52511312-300
● FA52511318-300
● FA52511330-300
● FA52511333-300 | ○ FA52511201-300
● FA52511206-300
● FA52511212-300
● FA52511218-300
● FA52511230-300
● FA52511233-300 |

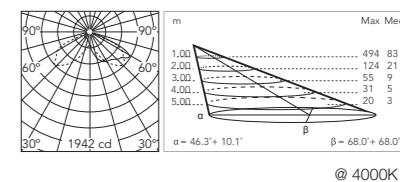

Perseo 4 RGB

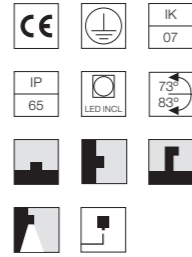
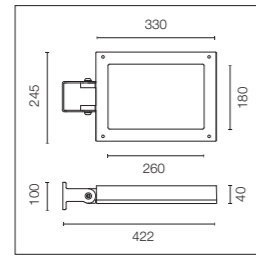
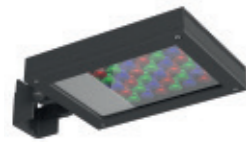

Sorgente a LED inclusa. Alimentazione elettrica 220-240V. Staffa di fissaggio graduata inclusa. Dotato di pressacavo in metallo M20x1,5 (per cavi 7mmϕ<math><13\text{mm}</math>). Per garantire la tenuta del pressacavo è consigliabile utilizzare cavi elettrici flessibili idonei all'impiego in ambienti esterni. Accessori opzionali: braccio in aggetto a parete; pali e relativi bracci per installazione come testapalo; visiera wall-washer e ghiera anti-vandalò. Vetro trasparente extrachiaro.

LED source included. Integrated power supply 220-240V. Graduated fixing bracket included. Equipped with a M20x1.5 cable guide (for 7mmϕ<math><13\text{mm}</math> cables) and IP68 connector. To ensure the tightness of the cable guide it's recommended to use flexible electric cables suitable for exterior use. Optional accessories: protruding arm for walls; feet and arms to install the luminaire on a mast; wall-washer visor and anti-vandalism protection lid. Extraclear transparent glass.

Schema elettrico e installazione sistema RGB.

Vedere Schema Elettrico n.8 Page 671.

Wiring diagram and installation scheme RGB.

See Wiring Diagram n.8 Page 671.

Optic Medium 40°

RGB Power Led: 40W - 220-240V with DMX interface.

RGB

- FA52512401
- FA52512406
- FA52512412
- FA52512418
- FA52512430
- FA52512433

Perseo 4 LED / Ø 76mm - Poles

Con Base e Portella con Morsettieria.

With Base and Access Door .
With Terminal Block 4x1,5-16mmq.



H 3500mm

- FA24806
- FA24833

H 4500mm

- FA24906
- FA24933

Da Interrare (+500 mm Interrati) e Portella con Morsettieria

In-Ground (+500 mm Root) With Access Door
With Terminal Block 4x1,5-16mmq



H 3500mm

- FA25006
- FA25033

H 4500mm

- FA25106
- FA25133

Perseo 4 LED / Ø 102mm - Poles

Con Base e Portella con Morsettieria.

With Base and Access Door .
With Terminal Block 4x1,5-16mmq.



H 4000mm

- FA414006
- FA414033

H 5000mm

- FA415006
- FA415033

Da Interrare (+500 mm Interrati) e Portella con Morsettieria

In-Ground (+500 mm Root) With Access Door
With Terminal Block 4x1,5-16mmq



H 4000mm

- FA414506
- FA414533







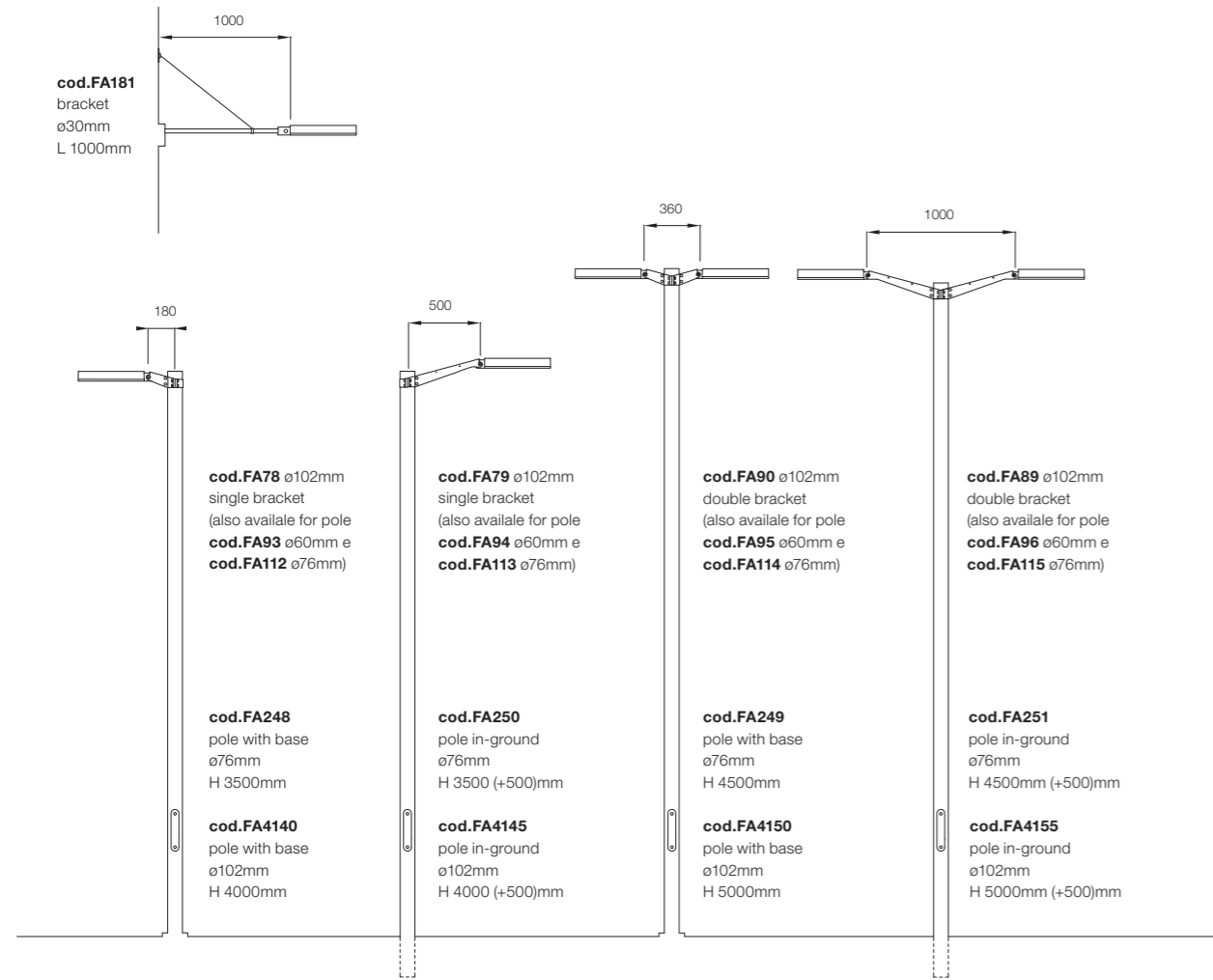



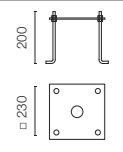

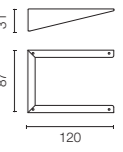

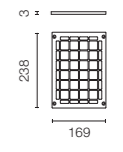
H 5000mm

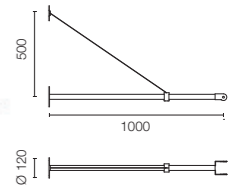
- FA415506
- FA415533

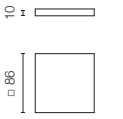
Installation scheme: Perseo 4

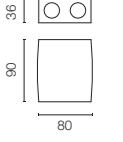

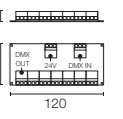

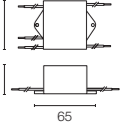



Perseo 4: Accessori / Accessories

Piastra tirafondi.	Base plate with bolt.	FA116		
Visiera Wall-Washer	Wall Washer Visor	FA16730		
Ghiera anti vandali	Anti vandal louvre	FA16830		
Braccio 1000mm.	Wall Bracket 1000mm.	○ FA18101 ● FA18106 ● FA18112 ● FA18118 ● FA18130 ● FA18133		
Controller DMX a parete per scatole ad incasso (60mm interasse fori).	DMX controller; dimmer switch for recessed box (60mm hole centres).	RGB version F990B10A000		
Controller DMX stand-alone/interfaccia PC.	DMX controller; stand-alone/PC interface.	RGB version F990B11A000		
DMX splitter 512 - dispositivo elettronico per rigenerare segnale DMX monodirezionale 1 Input e 7 output, 12-24 Vdc. Alimentatore non incluso.	DMX splitter 512 - electronic device to regenerate the monodirectional DMX signal 1 Input and 7 output, 12-24Vdc. Power supply not included.	RGB version F990B13A000		
Cavo DMX schermato con impedenza costante 110 Ohm.	DMX cable - shielded twisted pair with 110 Ohm constant impedance.	RGB version F990B12A000		
Dispositivo di protezione per il sovraccarico. 275Vac. Corrente massima di scarica 10KA (8/29µs). Massima corrente operativa 5A. Adatto per la connessione in serie. IP66.	Surge protection device. 275Vac. Maximum discharge current 10KA (8/20µs). Maximum operating current 5A. Suitable for series connection. IP66.	F990E00A000		

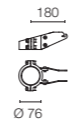
Perseo 4 Ø 60mm

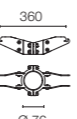
Braccio singolo 180mm. Per palo Ø 60mm.	Single bracket 180mm. For pole Ø 60mm.	● FA9306 ● FA9333		
Braccio doppio 180mm Per palo Ø 60mm.	Double bracket 180mm. For pole Ø 60mm.	● FA9506 ● FA9533		
Braccio singolo 500mm. Per palo Ø 60mm.	Single bracket 500mm. For pole Ø 60mm.	● FA9406 ● FA9433		
Braccio doppio 500mm Per palo Ø 60mm.	Double bracket 500mm. For pole Ø 60mm.	● FA9606 ● FA9633		

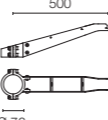
Perseo 4 Ø 76mm

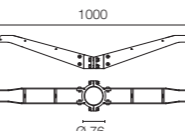
Braccio singolo 180mm. Per palo Ø 76mm.	Single bracket 180mm. For pole Ø 76mm.	● FA11206 ● FA11233		
Braccio doppio 180mm Per palo Ø 76mm.	Double bracket 180mm. For pole Ø 76mm.	● FA11406 ● FA11433		
Braccio singolo 500mm. Per palo Ø 76mm.	Single bracket 500mm. For pole Ø 76mm.	● FA11306 ● FA11333		
Braccio doppio 500mm Per palo Ø 76mm.	Double bracket 500mm. For pole Ø 76mm.	● FA11506 ● FA11533		

Perseo 4 Ø 102mm

Braccio singolo 180mm. Per palo Ø 102mm.	Single bracket 180mm. For pole Ø 102mm.	● FA7806 ● FA7833		
Braccio doppio 180mm Per palo Ø 102mm.	Double bracket 180mm. For pole Ø 102mm.	● FA9006 ● FA9033		
Braccio singolo 500mm. Per palo Ø 102mm.	Single bracket 500mm. For pole Ø 102mm.	● FA7906 ● FA7933		
Braccio doppio 500mm Per palo Ø 102mm.	Double bracket 500mm. For pole Ø 102mm.	● FA8906 ● FA8933		

Dooku



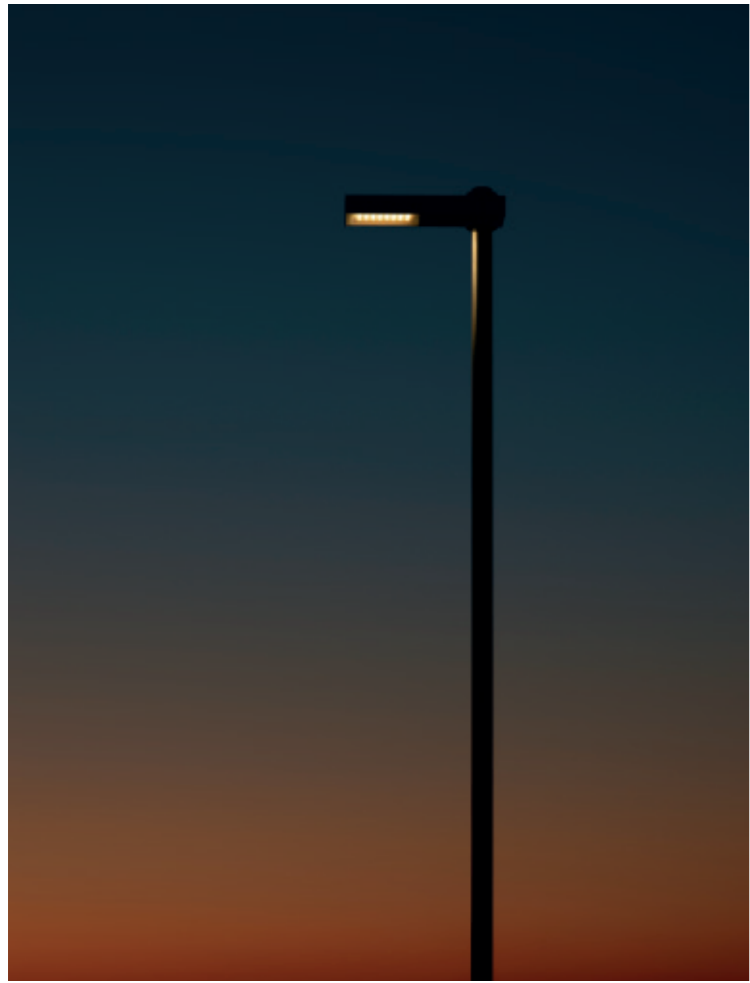

Famiglia / Family

Dooku 400 Wall



Power Led
up to 39W
up to 2946 lm - 2700K/CRI 80
up to 3168 lm - 3000K/CRI 80
up to 3374 lm - 4000K/CRI 80
* Net lumen output

Dooku 400 Pole/Double Pole Ø76



Power Led
up to 39W
up to 3389 lm - 2700K/CRI 80
up to 3631 lm - 3000K/CRI 80
up to 3752 lm - 4000K/CRI 80
* Net lumen output

Power Led
up to 2x39W
up to 2x3389 lm - 2700K/CRI 80
up to 2x3631 lm - 3000K/CRI 80
up to 2x3752 lm - 4000K/CRI 80
* Net lumen output

Dooku 400 Pole/Double Pole Ø102



Power Led
up to 39W
up to 3389 lm - 2700K/CRI 80
up to 3631 lm - 3000K/CRI 80
up to 3752 lm - 4000K/CRI 80
* Net lumen output

Power Led
up to 2x39W
up to 2x3389 lm - 2700K/CRI 80
up to 2x3631 lm - 3000K/CRI 80
up to 2x3752 lm - 4000K/CRI 80
* Net lumen output

Dooku 600 Pole/Double Pole Ø76



Power Led
up to 78W
up to 6779 lm - 2700K/CRI 80
up to 7263 lm - 3000K/CRI 80
up to 7505 lm - 4000K/CRI 80
* Net lumen output

Power Led
up to 2x78W
up to 2x6779 lm - 2700K/CRI 80
up to 2x7263 lm - 3000K/CRI 80
up to 2x7505 lm - 4000K/CRI 80
* Net lumen output

Dooku 600 Pole/Double Pole Ø102



Power Led
up to 78W
up to 6779 lm - 2700K/CRI 80
up to 7263 lm - 3000K/CRI 80
up to 7505 lm - 4000K/CRI 80
* Net lumen output

Power Led
up to 2x78W
up to 2x6779 lm - 2700K/CRI 80
up to 2x7263 lm - 3000K/CRI 80
up to 2x7505 lm - 4000K/CRI 80
* Net lumen output

Colori / Colours

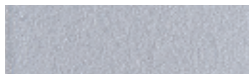

06 Grey



33 Anthracite

Descrizione / Description

Famiglia completa di apparecchi di illuminazione con sorgente luminosa a LED a proiezione, predisposti per installazione a parete e a palo come testapalo. Disponibile in due lunghezze e in varie ottiche per dimensione, comprese ottiche stradali per applicazioni in contesto urbano. Corpo in estruso di alluminio con parti di chiusura in alluminio pressofuso lega EN AB 47100 (a basso contenuto di rame). Diffusore in vetro extrachiaro con bordo se-grigrafato, fissato attraverso un sistema di incollaggio robotizzato. Disponibile in differenti finiture con rivestimento a doppio strato di polveri e sottoposte a trattamento di conversione chimica superficiale per una elevata resistenza alla corrosione. L'apparecchio è dotato di uno spezzone di cavo uscente in neoprene e connettore IP68 per il cablaggio facile e sicuro a tenuta stagna.

Dooku 400 Wall

Apparecchi orientabili a proiezione, predisposti per installazione a parete, disponibili in due fasci di apertura: simmetrica e asimmetrica per aree pubbliche e private urbane, spazi ampi, parcheggi. L'apparecchio è dotato di uno spezzone di cavo uscente in neoprene e connettori IP68 per il cablaggio facile e sicuro a tenuta stagna. La staffa di fissaggio zincata permette una orientabilità di 90° circa sull'asse verticale.

Dooku 400 / 600 Top Pole

Apparecchi testapalo predisposti per installazione a palo, disponibili in due lunghezze con differenze potenze e quattro fasci di apertura: simmetrico, asimmetrico, ottica stradale standard e ottica stradale dedicata per percorsi ciclo-pedonali per inserimento in contesto urbano. L'apparecchio è dotato di uno spezzone di cavo uscente in neoprene e connettori IP68 per il cablaggio facile e sicuro a tenuta stagna. Completano la gamma una serie completa di pali cilindrici di diverso diametro ed altezza da interrare o con base di fissaggio e tirafondi.

Complete family of tiltable projection luminaires with LED source for wall mounting and installation on masts. Available in two lengths and with different optics for every dimension, including optics for urban uses. Extruded EN AB-47100 die cast aluminum body and closing parts (with low copper content). Extraclear glass diffuser with silkscreen edge, attached with a robotic gluing system. Available in different finishes, with double-layered powder coating and chemical conversion surface treatment to ensure high corrosion resistance. Equipped with a neoprene cable section and IP68 connector to guarantee an easy, safe, and watertight connection.

Dooku 400 Wall

Tiltable projection luminaires for wall mounting. Available with two beam angles: symmetrical and asymmetrical for public, private, and urban areas, open spaces, or parking lots. Equipped with a neoprene cable section and IP68 connector to guarantee an easy, safe, and watertight connection. The zinc fixing bracket allows for a tilting of approx. 90° on the vertical axis.

Dooku 400 / 600 Top Pole

Mast luminaires for mounting on poles. Available in two lengths, with different output and four beam angles: symmetrical, asymmetrical, urban standard beam and a specific urban beam for pedestrian and bicycle lanes in urban contexts. Equipped with a neoprene cable section and IP68 connectors to guarantee an easy, safe, and watertight connection. Completed with a series of cylinder posts in different diameters and heights that can be ground recessed or fixed with an anchor plate and lag screws.

Dooku 400 – Wall

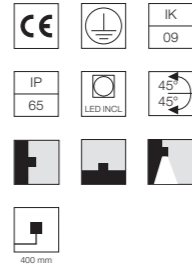
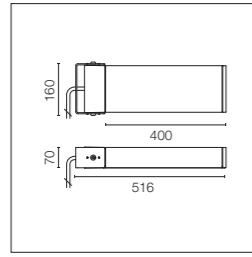

Sorgente a LED inclusa. Alimentazione elettrica 220-240V ON/OFF e dimmerabile 1-10V o DALI integrata. Staffa di fissaggio inclusa. Dotato di spezzone di cavo uscente in neoprene 400 mm e connettore IP68. Versione Smart- City a richiesta.

LED source included. Integrated power supply 220-240V ON/OFF and dimmable 1-10V or DALI. Fixing bracket included. Equipped with a 400mm protruding neoprene cable section and IP68 connectors. Smart-City version available upon request.

Optic 120° (Wide Spaces - Public Areas - Parking Areas)

Power Led: 39W - 4122 lm ≠ OUTPUT 3389 lm - 2700K/CRI 80 - 220÷240V / 39W - 4416 lm ≠ OUTPUT 3631 lm - 3000K/CRI 80 - 220÷240V / 39W - 4563 lm ≠ OUTPUT 3752 lm - 4000K/CRI 80 - 220÷240V

- | | | |
|---|---|---|
| 2700K
Non Dimmable
● FA53907606
● FA53907633
1-10V
● FA53907606-310
● FA53907633-310
Dali
● FA53907606-300
● FA53907633-300 | 3000K
Non Dimmable
● FA53907506
● FA53907533
1-10V
● FA53907506-310
● FA53907533-310
Dali
● FA53907506-300
● FA53907533-300 | 4000K
Non Dimmable
● FA53907406
● FA53907433
1-10V
● FA53907406-310
● FA53907433-310
Dali
● FA53907406-300
● FA53907433-300 |
|---|---|---|

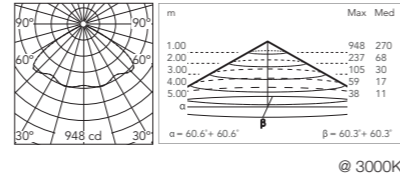

Asymmetric Optic

Power Led: 39W - 4122 lm ≠ OUTPUT 3173 lm - 2700K/CRI 80 - 220÷240V / 39W - 4416 lm ≠ OUTPUT 3400 lm - 3000K/CRI 80 - 220÷240V / 39W - 4563 lm ≠ OUTPUT 3513 lm - 4000K/CRI 80 - 220÷240V

- | | | |
|---|---|---|
| 2700K
Non Dimmable
● FA53913006
● FA53913033
1-10V
● FA53913006-310
● FA53913033-310
Dali
● FA53913006-300
● FA53913033-300 | 3000K
Non Dimmable
● FA53914806
● FA53914833
1-10V
● FA53914806-310
● FA53914833-310
Dali
● FA53914806-300
● FA53914833-300 | 4000K
Non Dimmable
● FA53916606
● FA53916633
1-10V
● FA53916606-310
● FA53916633-310
Dali
● FA53916606-300
● FA53916633-300 |
|---|---|---|

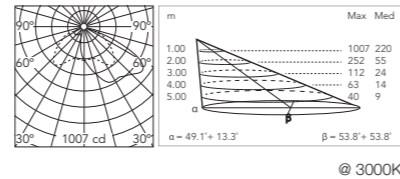

Dooku 400 - Single Top Pole ø76

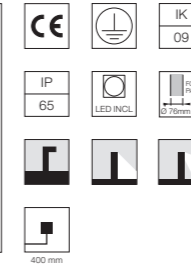
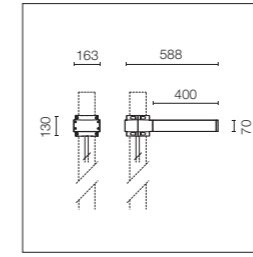

Sorgente a LED inclusa. Alimentazione elettrica 220-240V ON/OFF e dimmerabile 1-10V o DALI integrata. Staffa di fissaggio inclusa. Dotato di spezzone di cavo uscente in neoprene 400 mm e connettore IP68. Attacco singolo per pali diametro 76 mm, palo da ordinare separatamente. Versione Smart- City a richiesta.

LED source included. Integrated power supply 220-240V ON/OFF and dimmable 1-10V or DALI. Fixing bracket included. Equipped with a 400mm protruding neoprene cable section and IP68 connectors. Smart-City version available upon request. Single socket for 76mm diameter post. The post must be ordered separately. Smart-City version available upon request.

Optic 120° (Wide Spaces - Public Areas - Parking Areas)

Power Led: 39W - 4122 lm ≠ OUTPUT 3389 lm - 2700K/CRI 80 - 220÷240V / 39W - 4416 lm ≠ OUTPUT 3631 lm - 3000K/CRI 80 - 220÷240V / 39W - 4563 lm ≠ OUTPUT 3752 lm - 4000K/CRI 80 - 220÷240V

- | | | |
|---|---|---|
| 2700K
Non Dimmable
● FA53907806
● FA53907833
1-10V
● FA53907806-310
● FA53907833-310
Dali
● FA53907806-300
● FA53907833-300 | 3000K
Non Dimmable
● FA53903906
● FA53903933
1-10V
● FA53903906-310
● FA53903933-310
Dali
● FA53903906-300
● FA53903933-300 | 4000K
Non Dimmable
● FA53903806
● FA53903833
1-10V
● FA53903806-310
● FA53903833-310
Dali
● FA53903806-300
● FA53903833-300 |
|---|---|---|

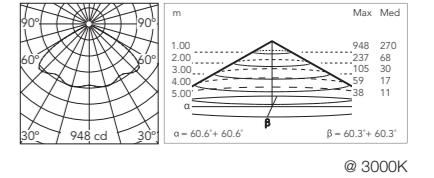

Asymmetric Optic

Power Led: 39W - 4122 lm ≠ OUTPUT 3173 lm - 2700K/CRI 80 - 220÷240V / 39W - 4416 lm ≠ OUTPUT 3400 lm - 3000K/CRI 80 - 220÷240V / 39W - 4563 lm ≠ OUTPUT 3513 lm - 4000K/CRI 80 - 220÷240V

- | | | |
|---|---|---|
| 2700K
Non Dimmable
● FA53913206
● FA53913233
1-10V
● FA53913206-310
● FA53913233-310
Dali
● FA53913206-300
● FA53913233-300 | 3000K
Non Dimmable
● FA53915006
● FA53915033
1-10V
● FA53915006-310
● FA53915033-310
Dali
● FA53915006-300
● FA53915033-300 | 4000K
Non Dimmable
● FA53916806
● FA53916833
1-10V
● FA53916806-310
● FA53916833-310
Dali
● FA53916806-300
● FA53916833-300 |
|---|---|---|

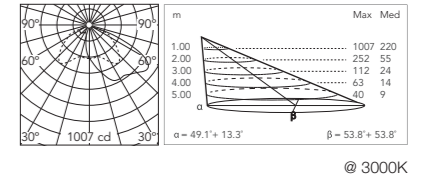

Street Light Optic

Power Led: 39W - 4122 lm ≠ OUTPUT 3102 lm - 2700K/CRI 80 - 220÷240V / 39W - 4416 lm ≠ OUTPUT 3323 lm - 3000K/CRI 80 - 220÷240V / 39W - 4563 lm ≠ OUTPUT 3434 lm - 4000K/CRI 80 - 220÷240V

- | | | |
|---|---|---|
| 2700K
Non Dimmable
● FA53908006
● FA53908033
1-10V
● FA53908006-310
● FA53908033-310
Dali
● FA53908006-300
● FA53908033-300 | 3000K
Non Dimmable
● FA53904206
● FA53904233
1-10V
● FA53904206-310
● FA53904233-310
Dali
● FA53904206-300
● FA53904233-300 | 4000K
Non Dimmable
● FA53904106
● FA53904133
1-10V
● FA53904106-310
● FA53904133-310
Dali
● FA53904106-300
● FA53904133-300 |
|---|---|---|

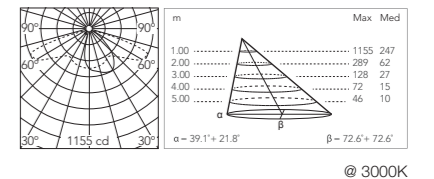

Street Light Optic (Foot and Cycle Paths)

Power Led: 39W - 4122 lm ≠ OUTPUT 3130 lm - 2700K/CRI 80 - 220÷240V / 39W - 4416 lm ≠ OUTPUT 3354 lm - 3000K/CRI 80 - 220÷240V / 39W - 4563 lm ≠ OUTPUT 3466 lm - 4000K/CRI 80 - 220÷240V

- | | | |
|---|---|---|
| 2700K
Non Dimmable
● FA53908206
● FA53908233
1-10V
● FA53908206-310
● FA53908233-310
Dali
● FA53908206-300
● FA53908233-300 | 3000K
Non Dimmable
● FA53904506
● FA53904533
1-10V
● FA53904506-310
● FA53904533-310
Dali
● FA53904506-300
● FA53904533-300 | 4000K
Non Dimmable
● FA53904406
● FA53904433
1-10V
● FA53904406-310
● FA53904433-310
Dali
● FA53904406-300
● FA53904433-300 |
|---|---|---|

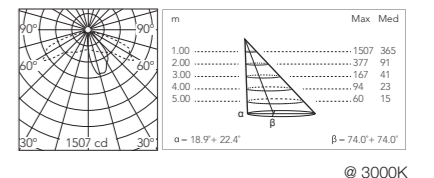

Dooku 400 - Double Top Pole ø76

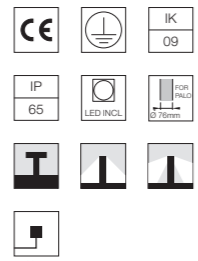
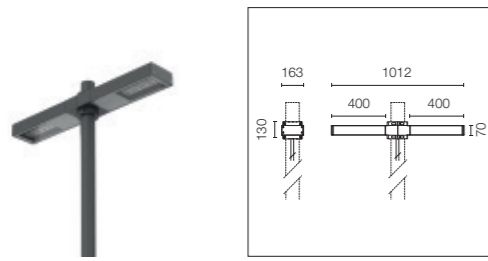

Sorgente a LED inclusa. Alimentazione elettrica 220-240V ON/OFF e dimmerabile 1-10V o DALI integrata. Staffa di fissaggio inclusa. Dotato di spezzone di cavo uscente in neoprene 400 mm e connettore IP68. Attacco doppio per pali diametro 76 mm, palo da ordinare separatamente. Versione Smart- City a richiesta.

LED source included. Integrated power supply 220-240V ON/OFF and dimmable 1-10V or DALI. Fixing bracket included. Equipped with a 400mm protruding neoprene cable section and IP68 connectors. Double socket for 76mm diameter post. The post must be ordered separately. Smart-City version available upon request.

400 mm

Optic 120° (Wide Spaces - Public Areas - Parking Areas)

Power Led: 39W - 2x4122 lm ≠ OUTPUT 2x3389 lm - 2700K/CRI 80 - 220÷240V / 39W - 2x4416 lm ≠ OUTPUT 2x3631 lm - 3000K/CRI 80 - 220÷240V / 39W - 2x4563 lm ≠ OUTPUT 2x3752 lm - 4000K/CRI 80 - 220÷240V

2700K	3000K	4000K
Non Dimmable	Non Dimmable	Non Dimmable
● FA53908406	● FA53904806	● FA53904706
● FA53908433	● FA53904833	● FA53904733
1-10V	1-10V	1-10V
● FA53908406-310	● FA53904806-310	● FA53904706-310
● FA53908433-310	● FA53904833-310	● FA53904733-310
Dali	Dali	Dali
● FA53908406-300	● FA53904806-300	● FA53904706-300
● FA53908433-300	● FA53904833-300	● FA53904733-300

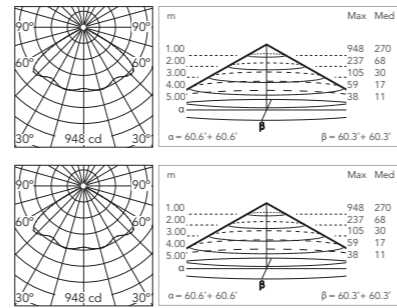

@ 3000K

Asymmetric Optic

Power Led: 39W - 2x4122 lm ≠ OUTPUT 2x3173 lm - 2700K/CRI 80 - 220÷240V / 39W - 2x4416 lm ≠ OUTPUT 2x3400 lm - 3000K/CRI 80 - 220÷240V / 39W - 2x4563 lm ≠ OUTPUT 2x3513 lm - 4000K/CRI 80 - 220÷240V

2700K	3000K	4000K
Non Dimmable	Non Dimmable	Non Dimmable
● FA53913406	● FA53915206	● FA53917006
● FA53913433	● FA53915233	● FA53917033
1-10V	1-10V	1-10V
● FA53913406-310	● FA53915206-310	● FA53917006-310
● FA53913433-310	● FA53915233-310	● FA53917033-310
Dali	Dali	Dali
● FA53913406-300	● FA53915206-300	● FA53917006-300
● FA53913433-300	● FA53915233-300	● FA53917033-300

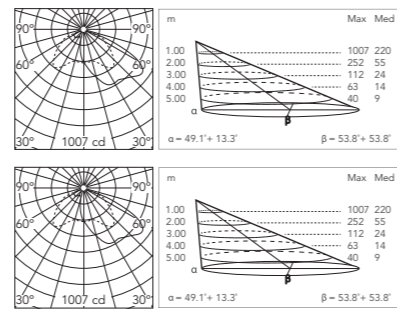

@ 3000K

Street Light Optic

Power Led: 39W - 2x4122 lm ≠ OUTPUT 2x3102 lm - 2700K/CRI 80 - 220÷240V / 39W - 2x4416 lm ≠ OUTPUT 2x3323 lm - 3000K/CRI 80 - 220÷240V / 39W - 2x4563 lm ≠ OUTPUT 2x3434 lm - 4000K/CRI 80 - 220÷240V

2700K	3000K	4000K
Non Dimmable	Non Dimmable	Non Dimmable
● FA53908606	● FA53905106	● FA53905006
● FA53908633	● FA53905133	● FA53905033
1-10V	1-10V	1-10V
● FA53908606-310	● FA53905106-310	● FA53905006-310
● FA53908633-310	● FA53905133-310	● FA53905033-310
Dali	Dali	Dali
● FA53908606-300	● FA53905106-300	● FA53905006-300
● FA53908633-300	● FA53905133-300	● FA53905033-300

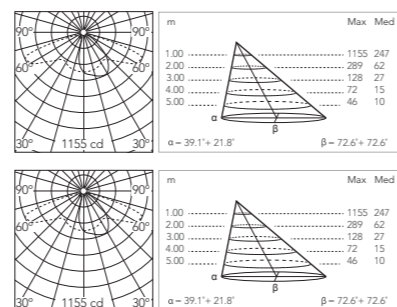

@ 3000K

Street Light Optic (Foot and Cycle Paths)

Power Led: 39W - 2x4122 lm ≠ OUTPUT 2x3130 lm - 2700K/CRI 80 - 220÷240V / 39W - 2x4416 lm ≠ OUTPUT 2x3354 lm - 3000K/CRI 80 - 220÷240V / 39W - 2x4563 lm ≠ OUTPUT 2x3466 lm - 4000K/CRI 80 - 220÷240V

2700K	3000K	4000K
Non Dimmable	Non Dimmable	Non Dimmable
● FA53908806	● FA53905406	● FA53905306
● FA53908833	● FA53905433	● FA53905333
1-10V	1-10V	1-10V
● FA53908806-310	● FA53905406-310	● FA53905306-310
● FA53908833-310	● FA53905433-310	● FA53905333-310
Dali	Dali	Dali
● FA53908806-300	● FA53905406-300	● FA53905306-300
● FA53908833-300	● FA53905433-300	● FA53905333-300

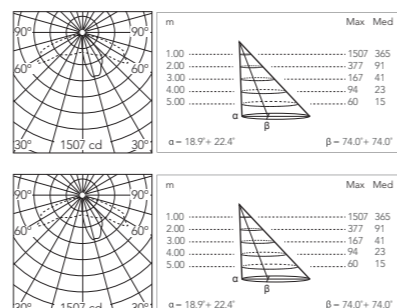

@ 3000K

Dooku

656

Dooku 400 - Single Top Pole ø102

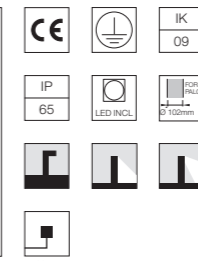
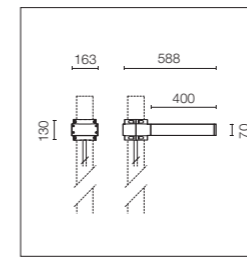

Sorgente a LED inclusa. Alimentazione elettrica 220-240V ON/OFF e dimmerabile 1-10V o DALI integrata. Staffa di fissaggio inclusa. Dotato di spezzone di cavo uscente in neoprene 400 mm e connettore IP68. Attacco singolo per pali diametro 102mm, palo da ordinare separatamente. Versione Smart- City a richiesta.

LED source included. Integrated power supply 220-240V ON/OFF and dimmable 1-10V or DALI. Fixing bracket included. Equipped with a 400mm protruding neoprene cable section and IP68 connectors. Smart-City version available upon request. Single socket for 102mm diameter post. The post must be ordered separately. Smart-City version available upon request.

400 mm

Optic 120° (Wide Spaces - Public Areas - Parking Areas)

Power Led: 39W - 4122 lm ≠ OUTPUT 3389 lm - 2700K/CRI 80 - 220÷240V / 39W - 4416 lm ≠ OUTPUT 3631 lm - 3000K/CRI 80 - 220÷240V / 39W - 4563 lm ≠ OUTPUT 3752 lm - 4000K/CRI 80 - 220÷240V

2700K	3000K	4000K
Non Dimmable	Non Dimmable	Non Dimmable
● FA53909006	● FA53905706	● FA53905606
● FA53909033	● FA53905733	● FA53905633
1-10V	1-10V	1-10V
● FA53909006-310	● FA53905706-310	● FA53905606-310
● FA53909033-310	● FA53905733-310	● FA53905633-310
Dali	Dali	Dali
● FA53909006-300	● FA53905706-300	● FA53905606-300
● FA53909033-300	● FA53905733-300	● FA53905633-300

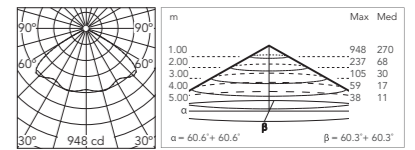

@ 3000K

Asymmetric Optic

Power Led: 39W - 4122 lm ≠ OUTPUT 3173 lm - 2700K/CRI 80 - 220÷240V / 39W - 4416 lm ≠ OUTPUT 3400 lm - 3000K/CRI 80 - 220÷240V / 39W - 4563 lm ≠ OUTPUT 3513 lm - 4000K/CRI 80 - 220÷240V

2700K	3000K	4000K
Non Dimmable	Non Dimmable	Non Dimmable
● FA53913606	● FA53915406	● FA53917206
● FA53913633	● FA53915433	● FA53917233
1-10V	1-10V	1-10V
● FA53913606-310	● FA53915406-310	● FA53917206-310
● FA53913633-310	● FA53915433-310	● FA53917233-310
Dali	Dali	Dali
● FA53913606-300	● FA53915406-300	● FA53917206-300
● FA53913633-300	● FA53915433-300	● FA53917233-300

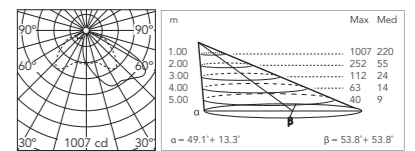

@ 3000K

Street Light Optic

Power Led: 39W - 4122 lm ≠ OUTPUT 3102 lm - 2700K/CRI 80 - 220÷240V / 39W - 4416 lm ≠ OUTPUT 3323 lm - 3000K/CRI 80 - 220÷240V / 39W - 4563 lm ≠ OUTPUT 3434 lm - 4000K/CRI 80 - 220÷240V

2700K	3000K	4000K
Non Dimmable	Non Dimmable	Non Dimmable
● FA53909206	● FA53906006	● FA53905906
● FA53909233	● FA53906033	● FA53905933
1-10V	1-10V	1-10V
● FA53909206-310	● FA53906006-310	● FA53905906-310
● FA53909233-310	● FA53906033-310	● FA53905933-310
Dali	Dali	Dali
● FA53909206-300	● FA53906006-300	● FA53905906-300
● FA53909233-300	● FA53906033-300	● FA53905933-300

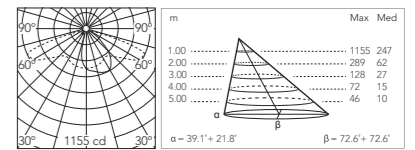

@ 3000K

Street Light Optic (Foot and Cycle Paths)

Power Led: 39W - 4122 lm ≠ OUTPUT 3130 lm - 2700K/CRI 80 - 220÷240V / 39W - 4416 lm ≠ OUTPUT 3354 lm - 3000K/CRI 80 - 220÷240V / 39W - 4563 lm ≠ OUTPUT 3466 lm - 4000K/CRI 80 - 220÷240V

2700K	3000K	4000K
Non Dimmable	Non Dimmable	Non Dimmable
● FA53909406	● FA53906306	● FA53906206
● FA53909433	● FA53906333	● FA53906233
1-10V	1-10V	1-10V
● FA53909406-310	● FA53906306-310	● FA53906206-310
● FA53909433-310	● FA53906333-310	● FA53906233-310
Dali	Dali	Dali
● FA53909406-300	● FA53906306-300	● FA53906206-300
● FA53909433-300	● FA53906333-300	● FA53906233-300

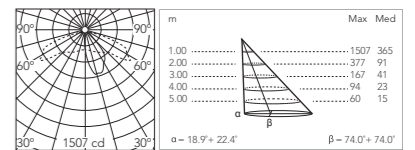

@ 3000K

657

Dooku

Dooku 400 - Double Top Pole ø102

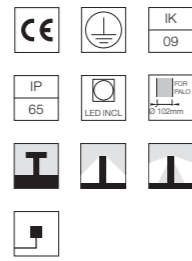
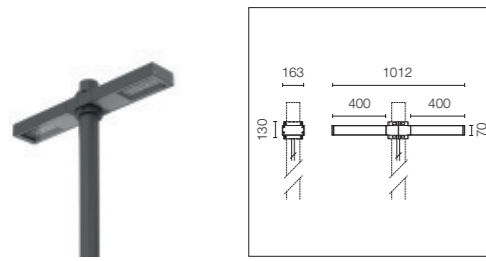

Sorgente a LED inclusa. Alimentazione elettrica 220-240V ON/OFF e dimmerabile 1-10V o DALI integrata. Staffa di fissaggio inclusa. Dotato di spezzone di cavo uscente in neoprene 400 mm e connettore IP68. Attacco doppio per pali diametro 102 mm, palo da ordinare separatamente. Versione Smart- City a richiesta.

LED source included. Integrated power supply 220-240V ON/OFF and dimmable 1-10V or DALI. Fixing bracket included. Equipped with a 400mm protruding neoprene cable section and IP68 connectors. Double socket for 102mm diameter post. The post must be ordered separately. Smart-City version available upon request.

Optic 120° (Wide Spaces - Public Areas - Parking Areas)

Power Led: 39W - 2x4122 lm ≠ OUTPUT 2x3389 lm - 2700K/CRI 80 - 220÷240V / 39W - 2x4416 lm ≠ OUTPUT 2x3631 lm - 3000K/CRI 80 - 220÷240V / 39W - 2x4563 lm ≠ OUTPUT 2x3752 lm - 4000K/CRI 80 - 220÷240V

2700K	3000K	4000K
Non Dimmable	Non Dimmable	Non Dimmable
● FA53909606	● FA53906606	● FA53906506
● FA53909633	● FA53906633	● FA53906533
1-10V	1-10V	1-10V
● FA53909606-310	● FA53906606-310	● FA53906506-310
● FA53909633-310	● FA53906633-310	● FA53906533-310
Dali	Dali	Dali
● FA53909606-300	● FA53906606-300	● FA53906506-300
● FA53909633-300	● FA53906633-300	● FA53906533-300

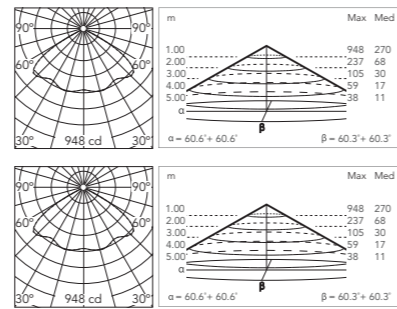

@ 3000K

Asymmetric Optic

Power Led: 39W - 2x4122 lm ≠ OUTPUT 2x3173 lm - 2700K/CRI 80 - 220÷240V / 39W - 2x4416 lm ≠ OUTPUT 2x3400 lm - 3000K/CRI 80 - 220÷240V / 39W - 2x4563 lm ≠ OUTPUT 2x3513 lm - 4000K/CRI 80 - 220÷240V

2700K	3000K	4000K
Non Dimmable	Non Dimmable	Non Dimmable
● FA53913806	● FA53915606	● FA53917406
● FA53913833	● FA53915633	● FA53917433
1-10V	1-10V	1-10V
● FA53913806-310	● FA53915606-310	● FA53917406-310
● FA53913833-310	● FA53915633-310	● FA53917433-310
Dali	Dali	Dali
● FA53913806-300	● FA53915606-300	● FA53917406-300
● FA53913833-300	● FA53915633-300	● FA53917433-300

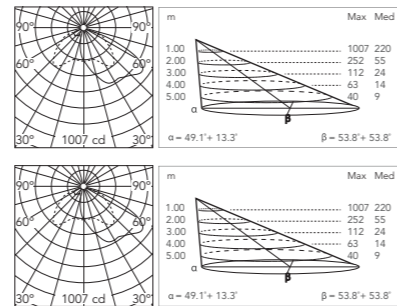

@ 3000K

Street Light Optic

Power Led: 39W - 2x4122 lm ≠ OUTPUT 2x3102 lm - 2700K/CRI 80 - 220÷240V / 39W - 2x4416 lm ≠ OUTPUT 2x3323 lm - 3000K/CRI 80 - 220÷240V / 39W - 2x4563 lm ≠ OUTPUT 2x3434 lm - 4000K/CRI 80 - 220÷240V

2700K	3000K	4000K
Non Dimmable	Non Dimmable	Non Dimmable
● FA53909806	● FA53906906	● FA53906806
● FA53909833	● FA53906933	● FA53906833
1-10V	1-10V	1-10V
● FA53909806-310	● FA53906906-310	● FA53906806-310
● FA53909833-310	● FA53906933-310	● FA53906833-310
Dali	Dali	Dali
● FA53909806-300	● FA53906906-300	● FA53906806-300
● FA53909833-300	● FA53906933-300	● FA53906833-300

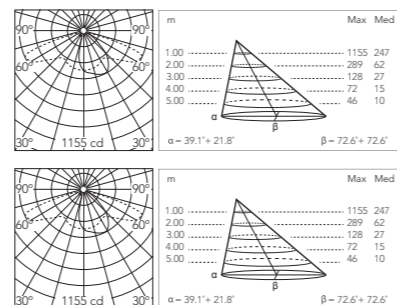

@ 3000K

Street Light Optic (Foot and Cycle Paths)

Power Led: 39W - 2x4122 lm ≠ OUTPUT 2x3130 lm - 2700K/CRI 80 - 220÷240V / 39W - 2x4416 lm ≠ OUTPUT 2x3354 lm - 3000K/CRI 80 - 220÷240V / 39W - 2x4563 lm ≠ OUTPUT 2x3466 lm - 4000K/CRI 80 - 220÷240V

2700K	3000K	4000K
Non Dimmable	Non Dimmable	Non Dimmable
● FA53910006	● FA53907206	● FA53907106
● FA53910033	● FA53907233	● FA53907133
1-10V	1-10V	1-10V
● FA53910006-310	● FA53907206-310	● FA53907106-310
● FA53910033-310	● FA53907233-310	● FA53907133-310
Dali	Dali	Dali
● FA53910006-300	● FA53907206-300	● FA53907106-300
● FA53910033-300	● FA53907233-300	● FA53907133-300

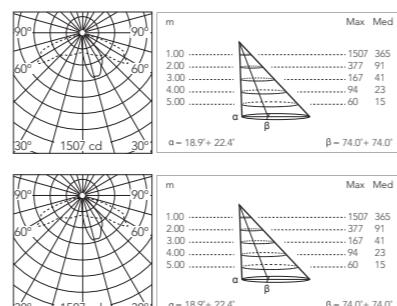

@ 3000K

Dooku 600 - Single Top Pole ø76

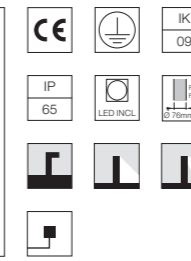
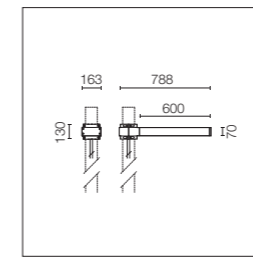

Sorgente a LED inclusa. Alimentazione elettrica 220-240V ON/OFF e dimmerabile 1-10V o DALI integrata. Staffa di fissaggio inclusa. Dotato di spezzone di cavo uscente in neoprene 400 mm e connettore IP68. Attacco singolo per pali diametro 76mm, palo da ordinare separatamente. Versione Smart- City a richiesta.

LED source included. Integrated power supply 220-240V ON/OFF and dimmable 1-10V or DALI. Fixing bracket included. Equipped with a 400mm protruding neoprene cable section and IP68 connectors. Smart-City version available upon request. Single socket for 76mm diameter post. The post must be ordered separately. Smart-City version available upon request.

Optic 120° (Wide Spaces - Public Areas - Parking Areas)

Power Led: 78W - 8243 lm ≠ OUTPUT 6779 lm - 2700K/CRI 80 - 220÷240V / 78W - 8832 lm ≠ OUTPUT 7263 lm - 3000K/CRI 80 - 220÷240V / 78W - 9126 lm ≠ OUTPUT 7505 lm - 4000K/CRI 80 - 220÷240V

2700K	3000K	4000K
Non Dimmable	Non Dimmable	Non Dimmable
● FA53910206	● FA53900306	● FA53900206
● FA53910233	● FA53900333	● FA53900233
1-10V	1-10V	1-10V
● FA53910206-310	● FA53900306-310	● FA53900206-310
● FA53910233-310	● FA53900333-310	● FA53900233-310
Dali	Dali	Dali
● FA53910206-300	● FA53900306-300	● FA53900206-300
● FA53910233-300	● FA53900333-300	● FA53900233-300

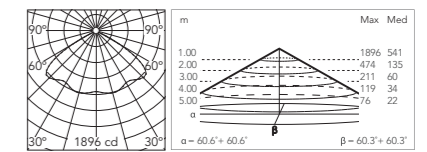

@ 3000K

Asymmetric Optic

Power Led: 78W - 8243 lm ≠ OUTPUT 6347 lm - 2700K/CRI 80 - 220÷240V / 78W - 8832 lm ≠ OUTPUT 6800 lm - 3000K/CRI 80 - 220÷240V / 78W - 9126 lm ≠ OUTPUT 7027 lm - 4000K/CRI 80 - 220÷240V

2700K	3000K	4000K
Non Dimmable	Non Dimmable	Non Dimmable
● FA53914006	● FA53915806	● FA53917606
● FA53914033	● FA53915833	● FA53917633
1-10V	1-10V	1-10V
● FA53914006-310	● FA53915806-310	● FA53917606-310
● FA53914033-310	● FA53915833-310	● FA53917633-310
Dali	Dali	Dali
● FA53914006-300	● FA53915806-300	● FA53917606-300
● FA53914033-300	● FA53915833-300	● FA53917633-300

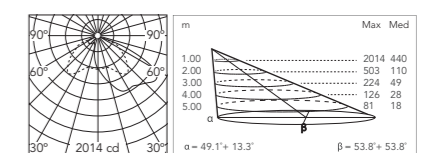

@ 3000K

Street Light Optic

Power Led: 78W - 8243 lm ≠ OUTPUT 6203 lm - 2700K/CRI 80 - 220÷240V / 78W - 8832 lm ≠ OUTPUT 6646 lm - 3000K/CRI 80 - 220÷240V / 78W - 9126 lm ≠ OUTPUT 6868 lm - 4000K/CRI 80 - 220÷240V

2700K	3000K	4000K
Non Dimmable	Non Dimmable	Non Dimmable
● FA53910406	● FA53900606	● FA53900506
● FA53910433	● FA53900633	● FA53900533
1-10V	1-10V	1-10V
● FA53910406-310	● FA53900606-310	● FA53900506-310
● FA53910433-310	● FA53900633-310	● FA53900533-310
Dali	Dali	Dali
● FA53910406-300	● FA53900606-300	● FA53900506-300
● FA53910433-300	● FA53900633-300	● FA53900533-300

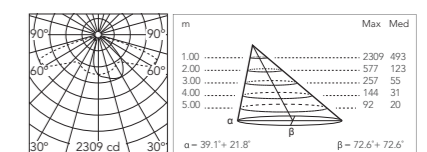

@ 3000K

Street Light Optic (Foot and Cycle Paths)

Power Led: 78W - 8243 lm ≠ OUTPUT 6261 lm - 2700K/CRI 80 - 220÷240V / 78W - 8832 lm ≠ OUTPUT 6708 lm - 3000K/CRI 80 - 220÷240V / 78W - 9126 lm ≠ OUTPUT 6932 lm - 4000K/CRI 80 - 220÷240V

2700K	3000K	4000K
Non Dimmable	Non Dimmable	Non Dimmable
● FA53910606	● FA53900906	● FA53900806
● FA53910633	● FA53900933	● FA53900833
1-10V	1-10V	1-10V
● FA53910606-310	● FA53900906-310	● FA53900806-310
● FA53910633-310	● FA53900933-310	● FA53900833-310
Dali	Dali	Dali
● FA53910606-300	● FA53900906-300	● FA53900806-300
● FA53910633-300	● FA53900933-300	● FA53900833-300

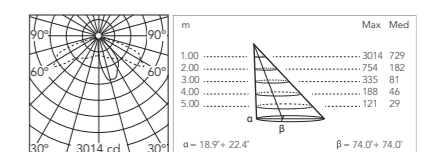

@ 3000K

Dooku 600 - Double Top Pole ø76

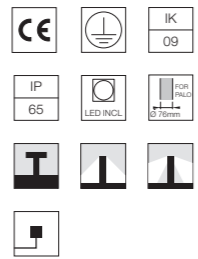
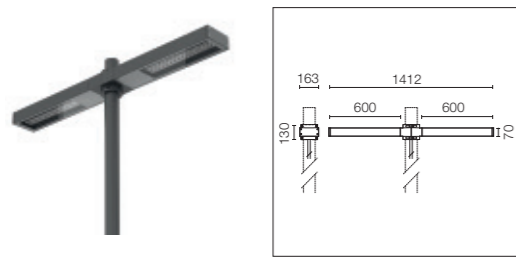

Sorgente a LED inclusa. Alimentazione elettrica 220-240V ON/OFF e dimmerabile 1-10V o DALI integrata. Staffa di fissaggio inclusa. Dotato di spezzone di cavo uscente in neoprene 400 mm e connettore IP68. Attacco doppio per pali diametro 76 mm, palo da ordinare separatamente. Versione Smart- City a richiesta.

LED source included. Integrated power supply 220-240V ON/OFF and dimmable 1-10V or DALI. Fixing bracket included. Equipped with a 400mm protruding neoprene cable section and IP68 connectors. Double socket for 76mm diameter post. The post must be ordered separately. Smart-City version available upon request.

Optic 120° (Wide Spaces - Public Areas - Parking Areas)

Power Led: 78W - 2x8243 lm ≠ OUTPUT 2x6779 lm - 2700K/CRI 80 - 220÷240V / 78W - 2x8832 lm ≠ OUTPUT 2x7263 lm - 3000K/CRI 80 - 220÷240V / 78W - 2x9126 lm ≠ OUTPUT 2x7505 lm - 4000K/CRI 80 - 220÷240V

2700K	3000K	4000K
Non Dimmable	Non Dimmable	Non Dimmable
● FA53910806	● FA53901206	● FA53901106
● FA53910833	● FA53901233	● FA53901133
1-10V	1-10V	1-10V
● FA53910806-310	● FA53901206-310	● FA53901106-310
● FA53910833-310	● FA53901233-310	● FA53901133-310
Dali	Dali	Dali
● FA53910806-300	● FA53901206-300	● FA53901106-300
● FA53910833-300	● FA53901233-300	● FA53901133-300

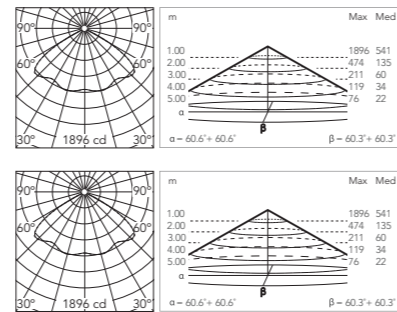

@ 3000K

Asymmetric Optic

Power Led: 78W - 2x8243 lm ≠ OUTPUT 2x6347 lm - 2700K/CRI 80 - 220÷240V / 78W - 2x8832 lm ≠ OUTPUT 2x6800 lm - 3000K/CRI 80 - 220÷240V / 78W - 2x9126 lm ≠ OUTPUT 2x7027 lm - 4000K/CRI 80 - 220÷240V

2700K	3000K	4000K
Non Dimmable	Non Dimmable	Non Dimmable
● FA53914206	● FA53916006	● FA53917806
● FA53914233	● FA53916033	● FA53917833
1-10V	1-10V	1-10V
● FA53914206-310	● FA53916006-310	● FA53917806-310
● FA53914233-310	● FA53916033-310	● FA53917833-310
Dali	Dali	Dali
● FA53914206-300	● FA53916006-300	● FA53917806-300
● FA53914233-300	● FA53916033-300	● FA53917833-300

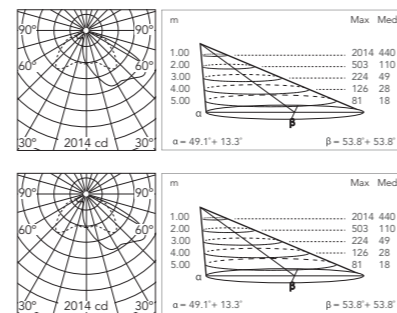

@ 3000K

Street Light Optic

Power Led: 78W - 2x8243 lm ≠ OUTPUT 2x6203 lm - 2700K/CRI 80 - 220÷240V / 78W - 2x8832 lm ≠ OUTPUT 2x6646 lm - 3000K/CRI 80 - 220÷240V / 78W - 2x9126 lm ≠ OUTPUT 2x6868 lm - 4000K/CRI 80 - 220÷240V

2700K	3000K	4000K
Non Dimmable	Non Dimmable	Non Dimmable
● FA53911006	● FA53901406	● FA53901406
● FA53911033	● FA53901533	● FA53901433
1-10V	1-10V	1-10V
● FA53911006-310	● FA53901506-310	● FA53901406-310
● FA53911033-310	● FA53901533-310	● FA53901433-310
Dali	Dali	Dali
● FA53911006-300	● FA53901506-300	● FA53901406-300
● FA53911033-300	● FA53901533-300	● FA53901433-300

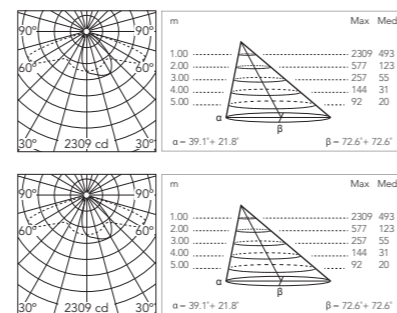

@ 3000K

Street Light Optic (Foot and Cycle Paths)

Power Led: 78W - 2x8243 lm ≠ OUTPUT 2x6261 lm - 2700K/CRI 80 - 220÷240V / 78W - 2x8832 lm ≠ OUTPUT 2x6708 lm - 3000K/CRI 80 - 220÷240V / 78W - 2x9126 lm ≠ OUTPUT 2x6932 lm - 4000K/CRI 80 - 220÷240V

2700K	3000K	4000K
Non Dimmable	Non Dimmable	Non Dimmable
● FA53911206	● FA53901806	● FA53901706
● FA53911233	● FA53901833	● FA53901733
1-10V	1-10V	1-10V
● FA53911206-310	● FA53901806-310	● FA53901706-310
● FA53911233-310	● FA53901833-310	● FA53901733-310
Dali	Dali	Dali
● FA53911206-300	● FA53901806-300	● FA53901706-300
● FA53911233-300	● FA53901833-300	● FA53901733-300

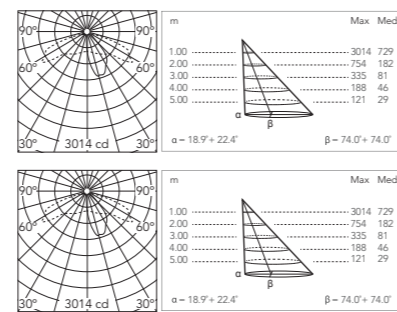

@ 3000K

Dooku 600 - Single Top Pole ø102

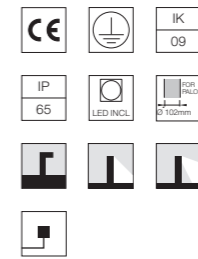
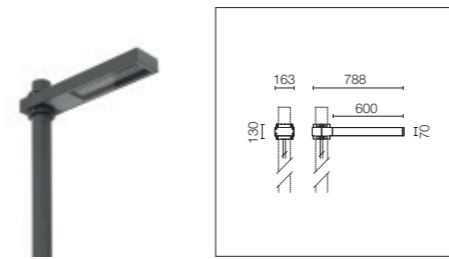

Sorgente a LED inclusa. Alimentazione elettrica 220-240V ON/OFF e dimmerabile 1-10V o DALI integrata. Staffa di fissaggio inclusa. Dotato di spezzone di cavo uscente in neoprene 400 mm e connettore IP68. Attacco singolo per pali diametro 102mm, palo da ordinare separatamente. Versione Smart- City a richiesta.

LED source included. Integrated power supply 220-240V ON/OFF and dimmable 1-10V or DALI. Fixing bracket included. Equipped with a 400mm protruding neoprene cable section and IP68 connectors. Smart-City version available upon request. Single socket for 102mm diameter post. The post must be ordered separately. Smart-City version available upon request.

Optic 120° (Wide Spaces - Public Areas - Parking Areas)

Power Led: 78W - 8243 lm ≠ OUTPUT 6779 lm - 2700K/CRI 80 - 220÷240V / 78W - 8832 lm ≠ OUTPUT 7263 lm - 3000K/CRI 80 - 220÷240V / 78W - 9126 lm ≠ OUTPUT 7505 lm - 4000K/CRI 80 - 220÷240V

2700K	3000K	4000K
Non Dimmable	Non Dimmable	Non Dimmable
● FA53911406	● FA53902106	● FA53902006
● FA53911433	● FA53902133	● FA53902033
1-10V	1-10V	1-10V
● FA53911406-310	● FA53902106-310	● FA53902006-310
● FA53911433-310	● FA53902133-310	● FA53902033-310
Dali	Dali	Dali
● FA53911406-300	● FA53902106-300	● FA53902006-300
● FA53911433-300	● FA53902133-300	● FA53902033-300

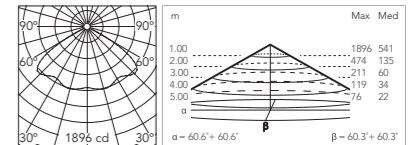

@ 3000K

Asymmetric Optic

Power Led: 78W - 8243 lm ≠ OUTPUT 6347 lm - 2700K/CRI 80 - 220÷240V / 78W - 8832 lm ≠ OUTPUT 6800 lm - 3000K/CRI 80 - 220÷240V / 78W - 9126 lm ≠ OUTPUT 7027 lm - 4000K/CRI 80 - 220÷240V

2700K	3000K	4000K
Non Dimmable	Non Dimmable	Non Dimmable
● FA53914406	● FA53916206	● FA53918006
● FA53914433	● FA53916233	● FA53918033
1-10V	1-10V	1-10V
● FA53914406-310	● FA53916206-310	● FA53918006-310
● FA53914433-310	● FA53916233-310	● FA53918033-310
Dali	Dali	Dali
● FA53914406-300	● FA53916206-300	● FA53918006-300
● FA53914433-300	● FA53916233-300	● FA53918033-300

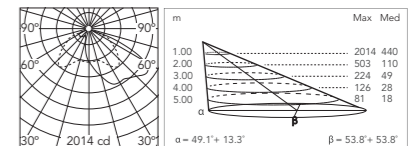

@ 3000K

Street Light Optic

Power Led: 78W - 8243 lm ≠ OUTPUT 6203 lm - 2700K/CRI 80 - 220÷240V / 78W - 8832 lm ≠ OUTPUT 6646 lm - 3000K/CRI 80 - 220÷240V / 78W - 9126 lm ≠ OUTPUT 6868 lm - 4000K/CRI 80 - 220÷240V

2700K	3000K	4000K
Non Dimmable	Non Dimmable	Non Dimmable
● FA53911606	● FA53902406	● FA53902306
● FA53911633	● FA53902433	● FA53902333
1-10V	1-10V	1-10V
● FA53911606-310	● FA53902406-310	● FA53902306-310
● FA53911633-310	● FA53902433-310	● FA53902333-310
Dali	Dali	Dali
● FA53911606-300	● FA53902406-300	● FA53902306-300
● FA53911633-300	● FA53902433-300	● FA53902333-300

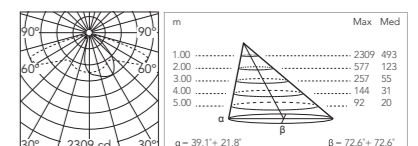

@ 3000K

Street Light Optic (Foot and Cycle Paths)

Power Led: 78W - 8243 lm ≠ OUTPUT 6261 lm - 2700K/CRI 80 - 220÷240V / 78W - 8832 lm ≠ OUTPUT 6708 lm - 3000K/CRI 80 - 220÷240V / 78W - 9126 lm ≠ OUTPUT 6932 lm - 4000K/CRI 80 - 220÷240V

2700K	3000K	4000K
Non Dimmable	Non Dimmable	Non Dimmable
● FA53911806	● FA53902706	● FA53902606
● FA53911833	● FA53902733	● FA53902633
1-10V	1-10V	1-10V
● FA53911806-310	● FA53902706-310	● FA53902606-310
● FA53911833-310	● FA53902733-310	● FA53902633-310
Dali	Dali	Dali
● FA53911806-300	● FA53902706-300	● FA53902606-300
● FA53911833-300	● FA53902733-300	● FA53902633-300

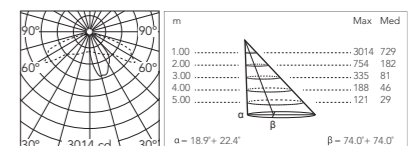

@ 3000K

Dooku 600 - Double Top Pole ø102

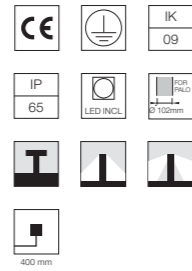
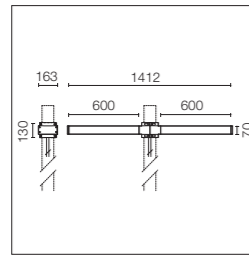

Sorgente a LED inclusa. Alimentazione elettrica 220-240V ON/OFF e dimmerabile 1-10V o DALI integrata. Staffa di fissaggio inclusa. Dotato di spezzone di cavo uscente in neoprene 400 mm e connettore IP68. Attacco doppio per pali diametro 102 mm, palo da ordinare separatamente. Versione Smart- City a richiesta.

LED source included. Integrated power supply 220-240V ON/OFF and dimmable 1-10V or DALI. Fixing bracket included. Equipped with a 400mm protruding neoprene cable section and IP68 connectors. Double socket for 102mm diameter post. The post must be ordered separately. Smart-City version available upon request.

Optic 120° (Wide Spaces - Public Areas - Parking Areas)

Power Led: 78W - 2x8243 lm ≠ OUTPUT 2x6779 lm - 2700K/CRI 80 - 220÷240V / 78W - 2x8832 lm ≠ OUTPUT 2x7263 lm - 3000K/CRI 80 - 220÷240V / 78W - 2x9126 lm ≠ OUTPUT 2x7505 lm - 4000K/CRI 80 - 220÷240V

- | | | |
|------------------------------|------------------------------|------------------------------|
| 2700K
Non Dimmable | 3000K
Non Dimmable | 4000K
Non Dimmable |
| ● FA53912006 | ● FA53903006 | ● FA53902906 |
| ● FA53912033 | ● FA53903033 | ● FA53902933 |
| 1-10V | 1-10V | 1-10V |
| ● FA53912006-310 | ● FA53903006-310 | ● FA53902906-310 |
| ● FA53912033-310 | ● FA53903033-310 | ● FA53902933-310 |
| Dali | Dali | Dali |
| ● FA53912006-300 | ● FA53903006-300 | ● FA53902906-300 |
| ● FA53912033-300 | ● FA53903033-300 | ● FA53902933-300 |

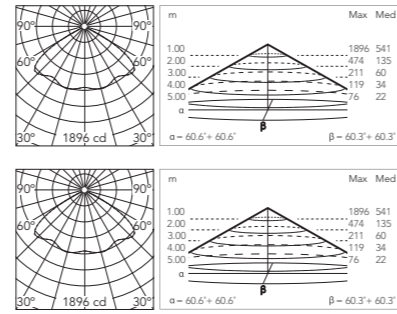

@ 3000K

Asymmetric Optic

Power Led: 78W - 2x8243 lm ≠ OUTPUT 2x6347 lm - 2700K/CRI 80 - 220÷240V / 78W - 2x8832 lm ≠ OUTPUT 2x6800 lm - 3000K/CRI 80 - 220÷240V / 78W - 2x9126 lm ≠ OUTPUT 2x7027 lm - 4000K/CRI 80 - 220÷240V

- | | | |
|------------------------------|------------------------------|------------------------------|
| 2700K
Non Dimmable | 3000K
Non Dimmable | 4000K
Non Dimmable |
| ● FA53914606 | ● FA53916406 | ● FA53918206 |
| ● FA53914633 | ● FA53916433 | ● FA53918233 |
| 1-10V | 1-10V | 1-10V |
| ● FA53914606-310 | ● FA53916406-310 | ● FA53918206-310 |
| ● FA53914633-310 | ● FA53916433-310 | ● FA53918233-310 |
| Dali | Dali | Dali |
| ● FA53914606-300 | ● FA53916406-300 | ● FA53918206-300 |
| ● FA53914633-300 | ● FA53916433-300 | ● FA53918233-300 |

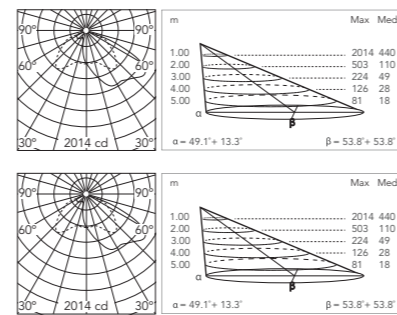

@ 3000K

Street Light Optic

Power Led: 78W - 2x8243 lm ≠ OUTPUT 2x6203 lm - 2700K/CRI 80 - 220÷240V / 78W - 2x8832 lm ≠ OUTPUT 2x6646 lm - 3000K/CRI 80 - 220÷240V / 78W - 2x9126 lm ≠ OUTPUT 2x6868 lm - 4000K/CRI 80 - 220÷240V

- | | | |
|------------------------------|------------------------------|------------------------------|
| 2700K
Non Dimmable | 3000K
Non Dimmable | 4000K
Non Dimmable |
| ● FA53912206 | ● FA53903306 | ● FA53903206 |
| ● FA53912233 | ● FA53903333 | ● FA53903233 |
| 1-10V | 1-10V | 1-10V |
| ● FA53912206-310 | ● FA53903306-310 | ● FA53903206-310 |
| ● FA53912233-310 | ● FA53903333-310 | ● FA53903233-310 |
| Dali | Dali | Dali |
| ● FA53912206-300 | ● FA53903306-300 | ● FA53903206-300 |
| ● FA53912233-300 | ● FA53903333-300 | ● FA53903233-300 |

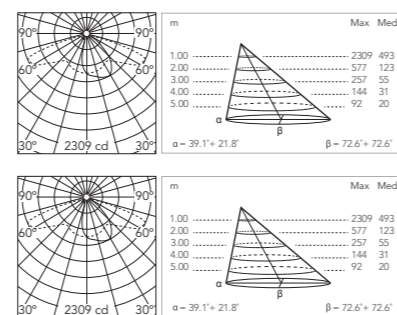

@ 3000K

Street Light Optic (Foot and Cycle Paths)

Power Led: 78W - 2x8243 lm ≠ OUTPUT 2x6261 lm - 2700K/CRI 80 - 220÷240V / 78W - 2x8832 lm ≠ OUTPUT 2x6708 lm - 3000K/CRI 80 - 220÷240V / 78W - 2x9126 lm ≠ OUTPUT 2x6932 lm - 4000K/CRI 80 - 220÷240V

- | | | |
|------------------------------|------------------------------|------------------------------|
| 2700K
Non Dimmable | 3000K
Non Dimmable | 4000K
Non Dimmable |
| ● FA53912406 | ● FA53903606 | ● FA53903506 |
| ● FA53912433 | ● FA53903633 | ● FA53903533 |
| 1-10V | 1-10V | 1-10V |
| ● FA53912406-310 | ● FA53903606-310 | ● FA53903506-310 |
| ● FA53912433-310 | ● FA53903633-310 | ● FA53903533-310 |
| Dali | Dali | Dali |
| ● FA53912406-300 | ● FA53903606-300 | ● FA53903506-300 |
| ● FA53912433-300 | ● FA53903633-300 | ● FA53903533-300 |

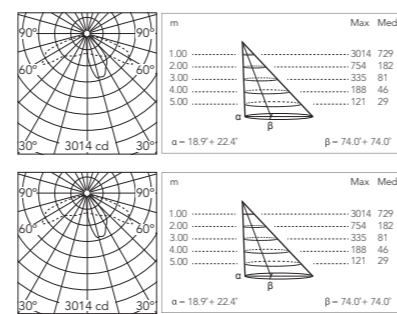

@ 3000K

Dooku / Ø 76mm - Poles

Con Base e Portella con Morsetti.

With Base and Access Door .
With Terminal Block 4x1,5-16mmq.



- H 3500mm**
- FA24806
 - FA24833
- H 4500mm**
- FA24906
 - FA24933

Da Interrare (+500 mm Interrati) e Portella con Morsetti.

In-Ground (+500 mm Root) With Access Door
With Terminal Block 4x1,5-16mmq



- H 3500mm**
- FA25006
 - FA25033
- H 4500mm**
- FA25106
 - FA25133

Dooku / Ø 102mm - Poles

Con Base e Portella con Morsetti.

With Base and Access Door .
With Terminal Block 4x1,5-16mmq.



- H 4000mm**
- FA414006
 - FA414033
- H 5000mm**
- FA415006
 - FA415033

Da Interrare (+500 mm Interrati) e Portella con Morsetti.

In-Ground (+500 mm Root) With Access Door
With Terminal Block 4x1,5-16mmq



- H 4000mm**
- FA414506
 - FA414533
- H 5000mm**
- FA415506
 - FA415533

Dooku: Accessori / Accessories

Piastra tirafondi.

Base plate with bolt.

FA116



Dispositivo di protezione per il sovraccarico. 275Vac. Corrente massima di scarica 10KA (8/29µs). Massima corrente operativa 5A. Adatto per la connessione in serie. IP66.

Surge protection device. 275Vac. Maximum discharge current 10KA (8/20µs). Maximum operating current 5A. Suitable for series connection. IP66.

F990E00A000

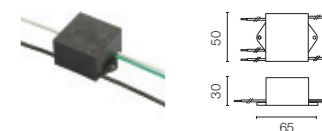

Classi di isolamento delle lampade / Luminaires classification



Classe I: lampada la cui protezione contro la scarica elettrica non si basa solo sull'isolamento di base dell'apparecchio, ma su un ulteriore sistema di sicurezza che consiste nel collegamento dei componenti conduttivi accessibili a un conduttore di sicurezza (messa a terra) facente parte dell'impianto elettrico fisso.

Class I: Luminaire in which protection against electrical shocks is not just based on the basic insulation but also on an additional safety precautions consisting of connecting the accesible conductive parts to a safety conductor (earth).



Classe II: Lampada la cui protezione contro la scarica elettrica non si basa solo sull'isolamento di base dell'apparecchio, ma su un ulteriore misura di sicurezza che consiste in un doppio isolamento rinforzato senza dispositivi per la messa a terra.

Class II: Luminaire in which protection against electrical shocks is not just based on the basic insulation but also on an additional safety precautions consisting of double reinforced insulation without conductive parts to a safety conductor (earth).



Classe III: Lampada la cui protezione contro la scarica elettrica si basa su un sistema a bassissima tensione, che non viene mai superata. Una lampada di Classe III non deve mai essere fornita con la messa a terra.

Class III: Luminaire in which protection against electrical shocks is based on the very low safety supply voltage and no voltages are produced higher than this. A Class III luminaire must never be provided with earthing.

Omologazioni / Homologations



Tutte le lampade prodotte e presentate in questo programma sono state realizzate in conformità con la Norma Europea EN 60 598 e sono pertanto conformi ai requisiti definiti nella Direttiva CEE 73/23 (Direttiva di Bassa Tensione). La loro realizzazione garantisce anche la conformità alla Direttiva 89/336 per quanto concerne la Compatibilità Elettromagnetica. Tutti i prodotti rientranti nel campo di applicazione delle suddette Direttive riportano la marcatura CE, che ne attesta la conformità ai relativi requisiti.

All lamps manufactured and illustrated in this catalog comply with European Standard EN 60 598 and consequently meet the requirements set forth in Directive 73/23 EEC (Low Voltage Directive). They also comply with Directive 89/336 covering electromagnetic compatibility. All products falling under the scope of the above-mentioned Directives bear the CE mark as proof of their compliance with the respective requirements.



La presenza del marchio ENEC sul prodotto conferma l'adempimento della Normativa Europea e garantisce l'affidabilità del sistema organizzativo e produttivo responsabile della fabbricazione del prodotto, attraverso un ente di certificazione accreditato. Il marchio ENEC conferma il nostro impegno ed è la migliore garanzia in tema di sicurezza e qualità di tutti i nostri prodotti.

The ENEC mark on the product stands for the compliance of European Standard as well as a trustworthy organisation and product system and is guaranteed by an accredited certification body. This agreed mark stands for our engagement and represents the best guarantee in security and quality matter of our products.



L'Associazione Spagnola di Normalizzazione e Certificazione AENOR certifica che il Sistema di garanzia di qualità adottato dalla Antares Iluminación S. A. soddisfa i requisiti della Norma Europea EN ISO 9001: Sistema di Qualità.

The Spanish Association for Standards and Certification AENOR, certifies that quality assurance system adopted by Antares Iluminación, S.A. complies with the requirements of the standard UNE-EN ISO-9001 Quality Systems.

IP
20

Indice di protezione contro la penetrazione di corpi solidi e di liquidi.

Protection degree offered by the fixture to the ingress of solids and liquids.

IP
20

1a cifra, protezione contro la penetrazione dei corpi solidi: 0 Nessuna protezione - 1 Protezione contro i corpi solidi di dimensioni superiori a 50mm - 2 Protezione contro i corpi solidi di dimensioni superiori a 12mm - 3 Protezione contro i corpi solidi di dimensioni superiori a 2,5mm - 4 Protezione contro i corpi solidi di dimensioni superiori a 1mm - 5 Protezione contro la polvere - 6 Totalmente protetto contro la polvere.

1st figure, protection against penetration by solid bodies: 0 No protection - 1 Protected against solid bodies over 50 mm in diameter - 2 Protected against solid bodies over 12 mm in diameter - 3 Protected against solid bodies over 2,5 mm in diameter - 4 Protected against solid bodies over 1 mm in diameter - 5 Protected against dust - 6 Fully protected against dust.

IP
20

2a cifra, protezione contro l'infiltrazione di acqua: 0 Nessuna protezione - 1 Protezione contro la caduta in verticale di gocce d'acqua - 2 Protezione contro la caduta in verticale di gocce d'acqua con angolo di inclinazione max di 15° - 3 Protezione contro la caduta in verticale di gocce d'acqua con angolo di inclinazione max di 60° - 4 Protezione contro gli spruzzi d'acqua - 5 Protezione contro i getti d'acqua - 6 Protezione contro le ondate d'acqua - 7 Protezione contro l'immersione - 8 Protezione contro l'immersione prolungata.

2nd figure, protection against penetration by water: 0 No protection - 1 Protected against drops of water falling vertically - 2 Protected against drops of water at a max. inclination of 15 degrees - 3 Protected against drops of water at a max. inclination of 60 degrees - 4 Protected against splashed of water - 5 Protected against jets of water - 6 Protected against waves - 7 Protected against immersion - 8 Protected against long term immersion.

Simbologia / Pictography

In conformità con quanto previsto dal Regolamento 874/2012/EU, integrazione della Direttiva 2010/30/UE e relativo all'etichettatura indicante il consumo d'energia delle lampade elettriche e la compatibilità degli apparecchi di illuminazione con le diverse fonti luminose (integrate o con questi compatibili), Flos S.p.A. ha inserito le etichette richieste, in formato elettronico, sul proprio sito (www.flos.com) nell'area relativa ai prodotti.

Le modalità per scaricare le etichette, nelle diverse lingue previste a livello comunitario, sono le seguenti: • Selezionare la collezione/il prodotto di interesse (per esempio <http://www.flos.com/decorative/en/products/floor/Arco>) • Cliccare "Vedi scheda tecnica" • Cliccare "Print Energy Label" • Selezionare la lingua e stampare l'etichetta.

In accordance with the provisions of Regulation 874/2012/EU and integration of the Directive 2010/30/EU concerning labeling indicating the energy consumption of electric lamps and the compatibility of lighting appliances with different light sources (integrated or compatible with these), Flos SpA has inserted the required labels, in electronic form, on its website (www.flos.com) in the area relating to products. The methods to download the labels in different languages envisaged at Community level are as follows: • Choose the collection/product you are interested in (for ex: <http://www.flos.com/decorative/en/products/floor/Arco>) • Click on "see specs sheet" • Click on "Print Energy Label" • Select the language and print the label.

Symbols



Resistenza al carico statico
In conformità alle norme CEI EN 60598-2-13.

Static load: Resistance to static load.
In compliance with CEI EN 60598-2-13 standards.



Resistenza alla torsione e allo scorrimento del carico
In conformità alle norme CEI EN 60598-2-13.

Drive over Resistance to torque and shear loads.
In compliance with CEI EN 60598-2-13 standards.



Temperatura del diffusore in conformità con la norma CEI EN 60598-2-13.
Controllare che la temperatura "T max ° C" del diffusore (testato a 25 ° C), sia conforme con la normativa locale.
Temperatura superficiale <70°C per sorgenti LED.

Diffuser temperature according to CEI EN 60598-2-13.
Check that diffuser's temperature "T max °C" (tested at 25°C) complies with your local regulation. Glass surface temperature <70°C for LED source



Consigli per la corretta installazione di apparecchi da incasso:
E' importante prevedere un efficace sistema di drenaggio dell'acqua.
L'apparecchio non deve essere installato in zone di ristagno.

Advice on installation of recessed luminaires:
It is important to provide a consistent gravel layer or drain system to ensure good drainage and to avoid water stagnation.
The luminaire must not be installed in hollow surfaces.

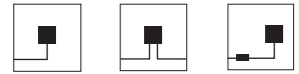

Connessione elettrica:
Connessione tramite uno o due ingressi cavo, oppure tramite apposito alimentatore remoto (disponibile separatamente).

Electric connection:
Wiring through cable input, through two cable inputs or through a feeding transformer installed on remote position (to be ordered separately).

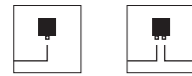

Apparecchio dotato di uno o due ingressi cavo.

Luminaire is equipped with 1 or 2 cable input.



Apparecchio dotato di cavo e spina.

Luminaire is equipped with cable and plug.



Protezione contro l'ingresso d'acqua dal cavo.

Protection against water ingress from the cable



Installazione a muro, a pavimento o a soffitto.

Surface installation on wall, on ground or on ceiling.



Installazione a palo.

Installation on pole.



Installazione ad incasso.
Installazione a sospensione.

In-ground installation (recessed luminaire)
Suspended fitting.



Test filo incandescente IEC 60695-2-10: test utilizzato per simulare l'effetto del calore che potrebbe presentarsi nelle apparecchiature elettriche malfunzionanti, ad esempio con componenti sovraccarichi (temperatura specificata).

Glow wire test IEC 60695-2-10: the glow wire test is used to simulate the effect of heat as may arise in malfunctioning electrical equipment, such as with overloaded (specified temperature).

Symbols



Resistenza a impatti meccanici esterni:
Il codice IK si riferisce al massimo impatto esterno che l'apparecchio è in grado di sopportare, senza danni irreversibili. In conformità con gli standard EN50102.

Resistance to external mechanical impacts:
IK code refers to the maximum external impact the luminaire is capable to withstand, without irreversible damage.
In compliance with EN50102 standards.

IK code	Impact Energy (Joule)	Mass/Height
IK00	0,00	-----
IK01	0,15	0,2Kg/70mm
IK02	0,20	0,2Kg/100mm
IK03	0,35	0,2Kg/175mm
IK04	0,50	0,2Kg/250mm
IK05	0,70	0,2Kg/350mm
IK06	1,00	0,5Kg/200mm
IK07	2,00	0,5Kg/400mm
IK08	5,00	1,7Kg/295mm
IK09	10,00	5,0Kg/200mm
IK10	20,00	5,0Kg/400mm

Tecnical Schemes

Schema elettrico ed esempio di installazione in serie / Wiring Diagram and sample series installation

n.1

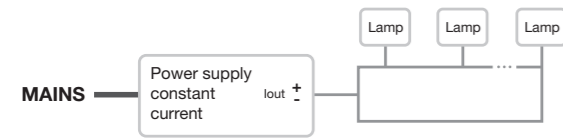

Schema elettrico ed esempio di installazione in parallelo / Wiring Diagram and sample parallel installation

n.2

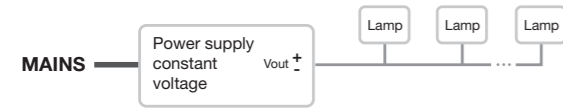

Schema elettrico ed esempio di installazione in serie dimmerabile / Wiring Diagram and sample dimmable series installation

n.3

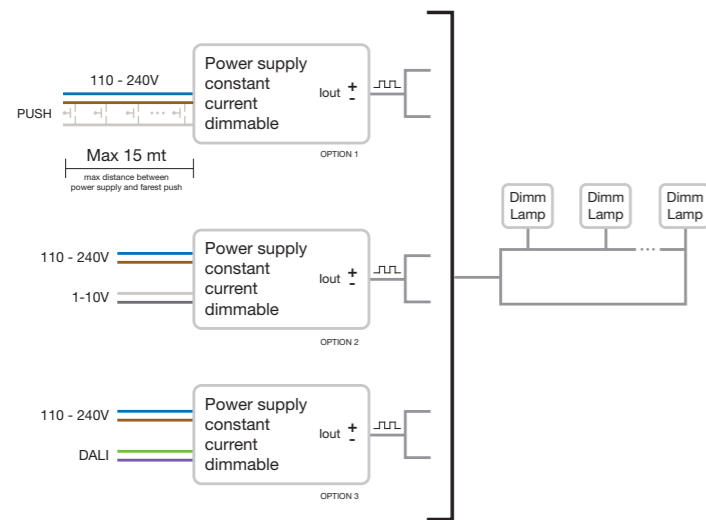

Schema elettrico ed esempio di installazione in parallelo dimmerabile / Wiring Diagram and sample dimmable parallel installation

n.4

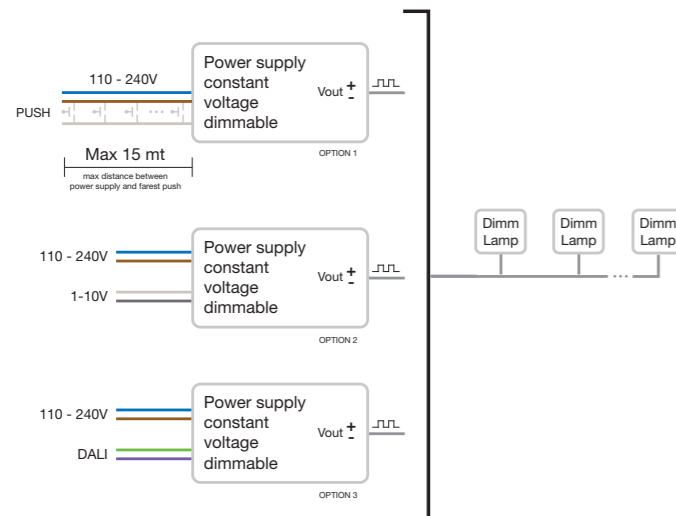

Basic DMX Wiring Scheme

Un sistema di DMX può includere un numero illimitato di apparecchi, a condizione che le seguenti regole siano rispettate:

- Usare cavi adatti per DMX bus: cavi DMX con impedenza costante 110 Ohm (Cod.186). L'uso di cavi diversi non garantisce le stesse prestazioni.
- Ogni 400 mt il segnale DMX bus deve essere rigenerato con uno Splitter. Questo permette di estendere l'installazione.
- Ogni 20 apparecchi il segnale bus DMX ha bisogno di essere rigenerato con una Splitter. Questo permette di estendere l'installazione.
- Tutti gli apparecchi devono essere collegati in serie al bus DMX (Nessun collegamento a stella). Si deve tenere conto che l'uso di uno splitter può risolvere il problema di avere un ingresso bus e più uscite bus.
- Ogni cavo deve avere una resistenza di terminazione di 120 Ohm.

A DMX system can include an unlimited number of fixtures on condition that the following rules are respected:

- Use suitable cables for DMX bus: shielded twisted pair with 110 Ohm constant impedance (e.g. Cod.186). The use of different cables doesn't assure the same performance.
- Every 400mt of cable the DMX bus signal needs to be regenerated with a Splitter. This allows to extend the installation.
- Every 20 fixtures the DMX bus signal needs to be regenerated with a Splitter. This allows to extend the installation.
- All fixtures have to be connected in series to the DMX bus. No star connection allowed. It has to be taken into account that the use of a splitter can solve the problem having one bus input and more bus output.
- Each cable must have a 120 Ohm termination resistor.

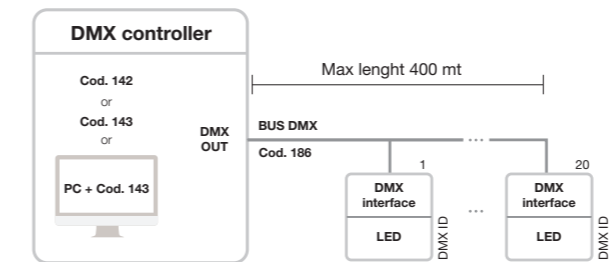

Extended DMX Wiring Pattern

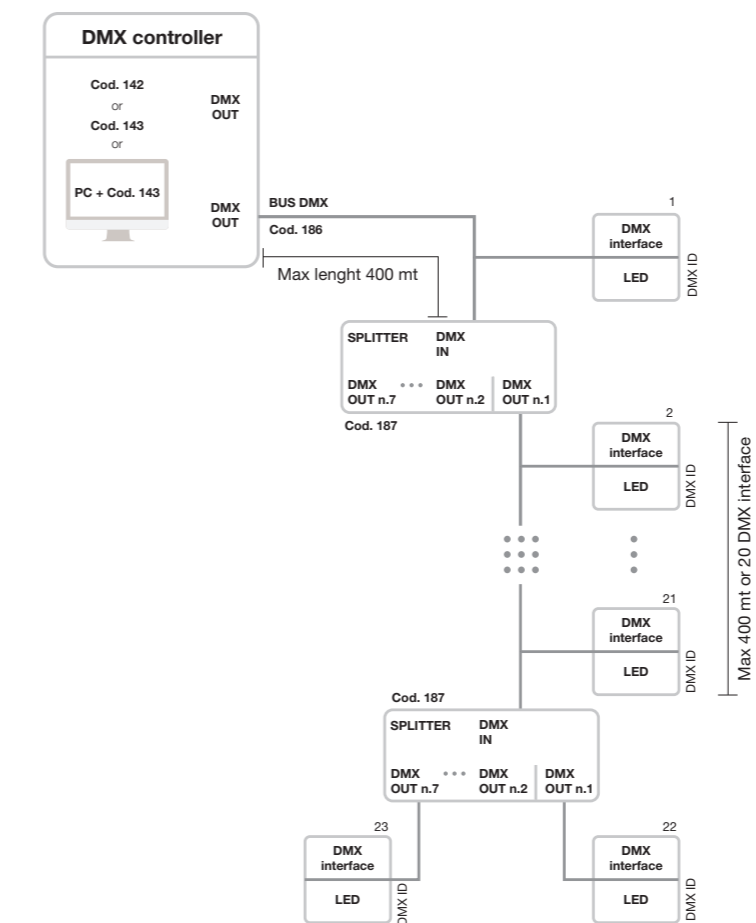

Tecnical Schemes

Schema elettrico ed esempio di installazione / Wiring Diagram and sample installation

n.5

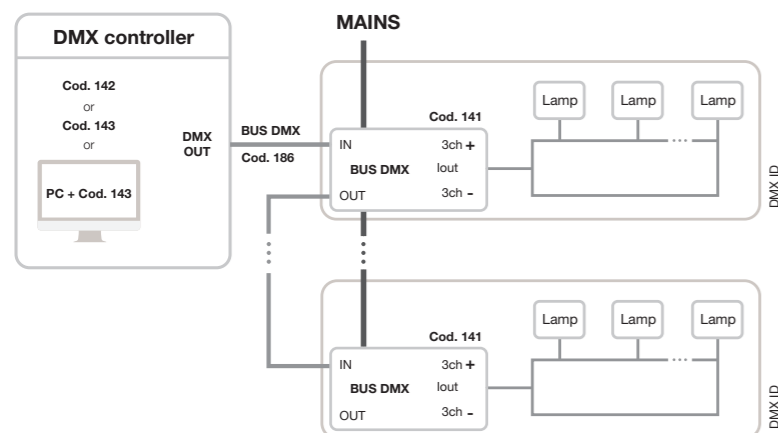

Schema elettrico ed esempio di installazione / Wiring Diagram and sample installation

n.6

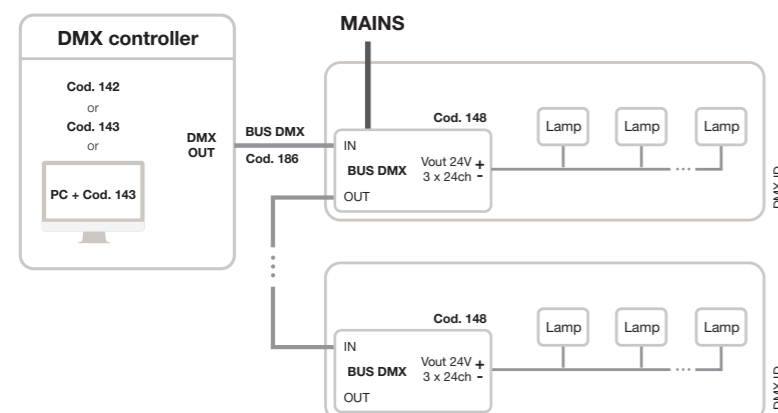

Tecnical Schemes

Schema elettrico ed esempio di installazione / Wiring Diagram and sample installation

n.7

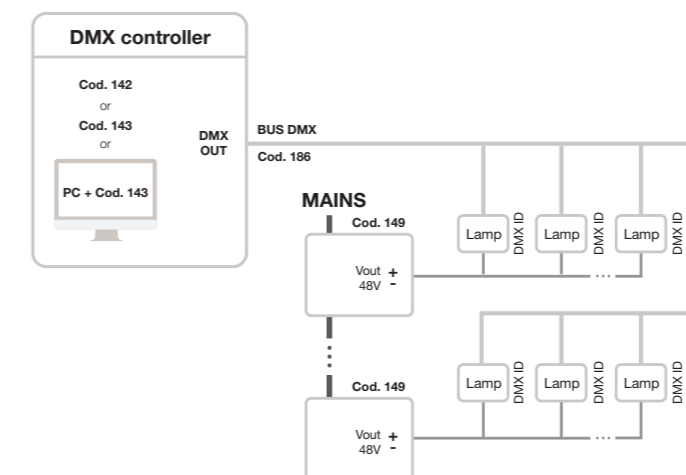

Schema elettrico ed esempio di installazione / Wiring Diagram and sample installation

n.8

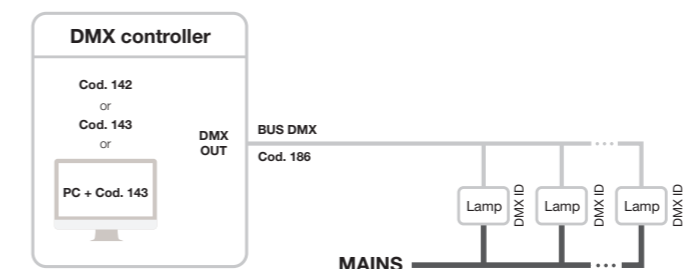

Attenzione

Cablaggio degli apparecchi a LED che funzionano in corrente costante e connessi in serie (schema 1): Non collegare l'apparecchio ad un alimentatore già collegato alla rete. Collegare sempre gli apparecchi all'alimentatore, e solo dopo collegare l'alimentatore alla rete.

Schemi di collegamento: apparecchi a corrente costante devono essere sempre collegati in serie, apparecchi in tensione costante devono essere sempre collegati in parallelo. Sempre rispettare polarità secondo il sistema DC.

Alimentatori devono sempre corrispondere alle funzioni di installazione: Non utilizzare un alimentatore a corrente costante su un apparecchio a tensione costante e viceversa.

La scelta dell'alimentatore deve tener conto del consumo reale dell'apparecchio (dati mostrati nel catalogo) con un aumento del 20% per affrontare qualsiasi perdita potenziale sull'impianto.

Gli apparecchi a LED e gli alimentatori sono protetti contro le interferenze sulla linea, è comunque altamente consigliabile impostare linee dedicate di alimentazione al fine di evitare qualsiasi potenziale interferenza improvvisa e grave (carichi induttivi, come pompe o lampade a scarica) che possono danneggiare il modulo LED.

Attention

Wiring of LED luminaires run in constant current and connected in series (schemes 1,3 and 5): Never connect the luminaire to a switched on power supply. Always connect luminaires to the power supply, and only after connect the power supply to the mains.

Connection schemes: Luminaires in constant current must always be connected in series; luminaires in constant tension must always be connected in parallel. Always respect polarity according to the DC system.

Power Supplies must always match installation features: Never use a constant current power supply on a constant tension luminaire and vice versa.

The choice of the power supply must take into account the real power consumption of the luminaire (data shown in the catalogue) with a 20% increase to face any potential loss on the installation.

LED Luminaires and power supplies are protected against interferences on the line, it is anyway highly recommended to set dedicated feeding lines to avoid any potential sudden and severe interference (inductive loads like pumps or discharge lamps) that are likely to damage the LED module.

Alphabetical Index

45	246	I - Ron	228
A-Rise	344	IC_Light	98
A-Round	334	In Vitro	46
Aimer	568	Kirk	548
Bellhop	158	Klein Pro	208
Belvedere	196	Landlord	140
C-Me	390	Leila	536
Camouflage	272	Lighting In The Rain	132
Casting	170	Marco	316
Caule	106	Mile	56
Cielo	476	My Way	264
Climber	282	Outgraze	414
Dooku	648	Perseo	624
Eclipse	488	Platter	508
Emma	520	Pointbreak	16
Fenestra	326	Real Matter	254
Flauta	122	Spock	556
Captain Flint	90	Talia	236
Franco	602	Tau	464
Gobi	368	Walkstick	182
Heavy Metal	294	Zefiro	218
Hyperion	498		

Garanzia

ARES s.r.l. garantisce al compratore la corretta realizzazione dei propri prodotti per un periodo di due anni dalla data della compravendita.

Durante il periodo di garanzia qualsiasi difetto di fabbricazione o di materiale sarà rettificato senza alcun addebito.

ARES s.r.l. si riserva il diritto di rettificare il danno attraverso la riparazione, il cambio o la sostituzione del/i prodotto/i.

La garanzia non copre ed il produttore non è responsabile di quanto segue:

Parti e materiali soggetti a continua usura;
Problematiche risultanti da cause esterne quali incidenti, abusi, utilizzo improprio, maneggiamento scorretto, negligenza, fuoco, furto, vandalismo, esplosioni, disastri naturali, o altre cause esterne non dipendenti dalla difettosità del prodotto stesso;
Condizioni che dimostrino una cattiva installazione, scorrette applicazioni, in stallazione in condizioni ambientali estreme diverse da quelle indicate nelle specifiche del prodotto stesso, situazioni sotto o sopra tensione di alimentazione, mancato rispetto delle istruzioni, maneggiamento, trasporto, manutenzione impropri o inadeguati, negligenza, accidentalità manomissioni del prodotto;
Incompatibilità: realizzazioni, installazioni, operazioni di manutenzione con prodotti non supportati dal produttore;
Situazioni in cui componenti dei prodotti vengano sostituiti con parti non fornite dal produttore;
La qualità di installazione sui prodotti dell'azienda produttrice dei sopraccitati componenti non forniti dal produttore.
Piccoli difetti che non abbiano ripercussioni sul valore o sul funzionamento dell'apparecchio.

La garanzia non si applica a qualsiasi altra richiesta (per esempio costi aggiuntivi sostenuti dal cliente), che non sia preventivamente concordata e accettata per iscritto con l'azienda produttrice

Warranty

ARES s.r.l. warrants to the Buyer the satisfactory operation of its products for the period of two years from date of Purchaser's purchase (the invoice date).

Within the warranty period any defects with ARES s.r.l. products as a result of faulty materials or workmanship will be rectified free of charge.

ARES s.r.l. reserves the right to rectify the fault by repair, exchange or replacement.

The warranty does not cover and the manufacturer will not be liable for:

Parts and materials subject to continuous wear;
Problems resulting from external causes such as accident, abuse, misuse, mishandling, negligence, fire, theft, vandalism, riot, explosion, natural disaster, or other external causes unrelated to product defect;
Conditions demonstrating faulty installation, misapplication, extreme environmental conditions beyond those defined in the product specification, under/over voltage situations, lack of compliance with applicable instructions, improper or inadequate handling, shipping, maintenance, negligence, accident, or tampering;
Incompatibility, improper design, manufacture, installation, operation or maintenance of products not supplied by Manufacturer;
Situations in which manufacturer's control gears fixtures and or any parts are replaced with those from other manufacturers;
The quality of the installation on Manufacturer products by the installer of those products. For example, the above warranties would not cover problems resulting from such an installer's installation methods.
Small defects having a negligible effect in value or operation.

The warranty does not apply to any other claims (for instance additional cost incurred by the customer) unless agreed and accepted by the manufacturer in writing.

Page	Reference	Page	Reference	Page	Reference	Page	Reference	Page	Reference
214	F002A40B012.A	215	F002B31B070.A	165	F003A21D030	166	F003B21D006	164	F003C21B033
214	F002A40B018.A	215	F002B31B071.A	165	F003A21D033	166	F003B21D012	164	F003C21B056
214	F002A40B030.A	215	F002B31D070.A	165	F003A21D056	166	F003B21D018	164	F003C21D001
214	F002A40B033.A	215	F002B31D071.A	165	F003A31A001	166	F003B21D030	164	F003C21D006
214	F002A40D001.A	215	F002B40A001.A	165	F003A31A006	166	F003B21D033	164	F003C21D012
214	F002A40D006.A	215	F002B40A006.A	165	F003A31A012	166	F003B21D056	164	F003C21D018
214	F002A40D012.A	215	F002B40A012.A	165	F003A31A018	166	F003B31A001	164	F003C21D030
214	F002A40D018.A	215	F002B40A018.A	165	F003A31A030	166	F003B31A006	164	F003C21D033
214	F002A40D030.A	215	F002B40A030.A	165	F003A31A033	166	F003B31A012	164	F003C21D056
214	F002A40D033.A	215	F002B40A033.A	165	F003A31A056	166	F003B31A018	164	F003C31A001
214	F002A41A070.A	215	F002B40B001.A	165	F003A31B001	166	F003B31A030	164	F003C31A006
214	F002A41A071.A	215	F002B40B006.A	165	F003A31B006	166	F003B31A033	164	F003C31A012
214	F002A41B070.A	215	F002B40B012.A	165	F003A31B012	166	F003B31A056	164	F003C31A018
214	F002A41B071.A	215	F002B40B018.A	165	F003A31B018	166	F003B31B001	164	F003C31A030
214	F002A41D070.A	215	F002B40B030.A	165	F003A31B030	166	F003B31B006	164	F003C31A033
214	F002A41D071.A	215	F002B40B033.A	165	F003A31B033	166	F003B31B012	164	F003C31A056
215	F002B20A001.A	215	F002B40D001.A	165	F003A31B056	166	F003B31B018	164	F003C31B001
215	F002B20A006.A	215	F002B40D006.A	165	F003A31D001	166	F003B31B030	164	F003C31B006
215	F002B20A012.A	215	F002B40D012.A	165	F003A31D006	166	F003B31B033	164	F003C31B012
215	F002B20A018.A	215	F002B40D018.A	165	F003A31D012	166	F003B31B056	164	F003C31B018
215	F002B20A030.A	215	F002B40D030.A	165	F003A31D018	166	F003B31D001	164	F003C31B030
215	F002B20A033.A	215	F002B40D033.A	165	F003A31D030	166	F003B31D006	164	F003C31B033
215	F002B20B001.A	215	F002B41A070.A	165	F003A31D033	166	F003B31D012	164	F003C31B056
215	F002B20B006.A	215	F002B41A071.A	165	F003A31D056	166	F003B31D018	164	F003C31D001
215	F002B20B012.A	215	F002B41B070.A	165	F003A41A001	166	F003B31D030	164	F003C31D006
215	F002B20B018.A	215	F002B41B071.A	165	F003A41A006	166	F003B31D033	164	F003C31D012
215	F002B20B030.A	215	F002B41D070.A	165	F003A41A012	166	F003B31D056	164	F003C31D018
215	F002B20B033.A	215	F002B41D071.A	165	F003A41A018	166	F003B41A001	164	F003C31D030
215	F002B20D001.A	216	F002Z010001.A	165	F003A41A030	166	F003B41A006	164	F003C31D033
215	F002B20D006.A	216	F002Z010006.A	165	F003A41A033	166	F003B41A012	164	F003C31D056
215	F002B20D012.A	216	F002Z010012.A	165	F003A41A056	166	F003B41A018	164	F003C41A001
215	F002B20D018.A	216	F002Z010018.A	165	F003A41B001	166	F003B41A030	164	F003C41A006
215	F002B20D030.A	216	F002Z010030.A	165	F003A41B006	166	F003B41A033	164	F003C41A012
215	F002B20D033.A	216	F002Z010033.A	165	F003A41B012	166	F003B41A056	164	F003C41A018
215	F002B21A070.A	216	F002Z020000	165	F003A41B018	166	F003B41B001	164	F003C41A030
215	F002B21A071.A	216	F002Z030000.A	165	F003A41B030	166	F003B41B006	164	F003C41A033
215	F002B21B070.A	216	F002Z040070.A	165	F003A41B033	166	F003B41B012	164	F003C41A056
215	F002B21B071.A	216	F002Z040071.A	165	F003A41B056	166	F003B41B018	164	F003C41B001
215	F002B21D070.A	216	F002Z040073.A	165	F003A41D001	166	F003B41B030	164	F003C41B006
215	F002B21D071.A	216	F002Z050070.A	165	F003A41D006	166	F003B41B033	164	F003C41B012
215	F002B30A001.A	216	F002Z050071.A	165	F003A41D012	166	F003B41B056	164	F003C41B018
215	F002B30A006.A	216	F002Z050073.A	165	F003A41D018	166	F003B41D001	164	F003C41B030
215	F002B30A012.A	165	F003A21A001	165	F003A41D030	166	F003B41D006	164	F003C41B033
215	F002B30A018.A	165	F003A21A006	165	F003A41D033	166	F003B41D012	164	F003C41B056
215	F002B30A030.A	165	F003A21A012	165	F003A41D056	166	F003B41D018	164	F003C41D001
215	F002B30A033.A	165	F003A21A018	166	F003B21A001	166	F003B41D030	164	F003C41D006
215	F002B30B001.A	165	F003A21A030	166	F003B21A006	166	F003B41D033	164	F003C41D012
215	F002B30B006.A	165	F003A21A033	166	F003B21A012	166	F003B41D056	164	F003C41D018
215	F002B30B012.A	165	F003A21A056	166	F003B21A018	164	F003C21A001	164	F003C41D030
215	F002B30B018.A	165	F003A21B001	166	F003B21A030	164	F003C21A006	164	F003C41D033
215	F002B30B030.A	165	F003A21B006	166	F003B21A033	164	F003C21A012	164	F003C41D056
215	F002B30B033.A	165	F003A21B012	166	F003B21A056	164	F003C21A018	168	F003G21A006
215	F002B30D001.A	165	F003A21B018	166	F003B21B001	164	F003C21A030	168	F003G21A018
215	F002B30D006.A	165	F003A21B030	166	F003B21B006	164	F003C21A033	168	F003G21A033
215	F002B30D012.A	165	F003A21B033	166	F003B21B012	164	F003C21A056	168	F003G21B006
215	F002B30D018.A	165	F003A21B056	166	F003B21B018	164	F003C21B001	168	F003G21B018
215	F002B30D030.A	165	F003A21D001	166	F003B21B030	164	F003C21B006	168	F003G21B033
215	F002B30D033.A	165	F003A21D006	166	F003B21B033	164	F003C21B012	168	F003G21D006
215	F002B31A070.A	165	F003A21D012	166	F003B21B056	164	F003C21B018	168	F003G21D018
215	F002B31A071.A	165	F003A21D018	166	F003B21D001	164	F003C21B030	168	F003G21D033

Page	Reference	Page	Reference	Page	Reference	Page	Reference	Page	Reference
168	F003G31A006	168	F003K31D006	153	F004A35A056	149	F004C30A012	147	F004E31A012
168	F003G31A018	168	F003K31D018	153	F004A35H056	149	F004C30A018	147	F004E31A018
168	F003G31A033	168	F003K31D033	152	F004A36A05601	149	F004C30A030	147	F004E31A030
168	F003G31B006	168	F003K41A006	152	F004A37A05602	149	F004C30A033	147	F004E31A033
168	F003G31B018	168	F003K41A018	152	F004A41A056	149	F004C40A001	147	F004E32A001
168	F003G31B033	168	F003K41A033	152	F004A41H056	149	F004C40A006	147	F004E32A006
168	F003G31D006	168	F003K41B006	152	F004A42A056	149	F004C40A012	147	F004E32A012
168	F003G31D018	168	F003K41B018	152	F004A42H056	149	F004C40A018	147	F004E32A018
168	F003G31D033	168	F003K41B033	152	F004A43A056	149	F004C40A030	147	F004E32A030
168	F003G41A006	168	F003K41D006	152	F004A43H056	149	F004C40A033	147	F004E32A033
168	F003G41A018	168	F003K41D018	153	F004A44A056	146	F004D21A001	147	F004E41A001
168	F003G41A033	168	F003K41D033	153	F004A44H056	146	F004D21A006	147	F004E41A006
168	F003G41B006	167	F003L21A006	153	F004A45A056	146	F004D21A012	147	F004E41A012
168	F003G41B018	167	F003L21A018	153	F004A45H056	146	F004D21A018	147	F004E41A018
168	F003G41B033	167	F003L21A033	152	F004A46A05601	146	F004D21A030	147	F004E41A030
168	F003G41D006	167	F003L21B006	152	F004A47A05602	146	F004D21A033	147	F004E41A033
168	F003G41D018	167	F003L21B018	154	F004B21A056	146	F004D22A001	147	F004E42A001
168	F003G41D033	167	F003L21B033	154	F004B21H056	146	F004D22A006	147	F004E42A006
167	F003H21A006	167	F003L21D006	154	F004B22A056	146	F004D22A012	147	F004E42A012
167	F003H21A018	167	F003L21D018	154	F004B22H056	146	F004D22A018	147	F004E42A018
167	F003H21A033	167	F003L21D033	154	F004B23A056	146	F004D22A030	147	F004E42A030
167	F003H21B006	167	F003L31A006	154	F004B23H056	146	F004D22A033	147	F004E42A033
167	F003H21B018	167	F003L31A018	155	F004B24A056	146	F004D31A001	146	F004F21A071
167	F003H21B033	167	F003L31A033	155	F004B24H056	146	F004D31A006	146	F004F22A071
167	F003H21D006	167	F003L31B006	155	F004B25A056	146	F004D31A012	146	F004F31A071
167	F003H21D018	167	F003L31B018	155	F004B25H056	146	F004D31A018	146	F004F32A071
167	F003H21D033	167	F003L31B033	154	F004B26A05601	146	F004D31A030	146	F004F41A071
167	F003H31A006	167	F003L31D006	154	F004B27A05602	146	F004D31A033	146	F004F42A071
167	F003H31A018	167	F003L31D018	154	F004B31A056	146	F004D32A001	147	F004G21A071
167	F003H31A033	167	F003L31D033	154	F004B31H056	146	F004D32A006	147	F004G22A071
167	F003H31B006	167	F003L41A006	154	F004B32A056	146	F004D32A012	147	F004G31A071
167	F003H31B018	167	F003L41A018	154	F004B32H056	146	F004D32A018	147	F004G32A071
167	F003H31B033	167	F003L41A033	154	F004B33A056	146	F004D32A030	147	F004G41A071
167	F003H31D006	167	F003L41B006	154	F004B33H056	146	F004D32A033	147	F004G42A071
167	F003H31D018	167	F003L41B018	155	F004B34A056	146	F004D41A001	149	F004H20A071
167	F003H31D033	167	F003L41B033	155	F004B34H056	146	F004D41A006	149	F004H30A071
167	F003H41A006	167	F003L41D006	155	F004B35A056	146	F004D41A012	149	F004H40A071
167	F003H41A018	167	F003L41D018	155	F004B35H056	146	F004D41A018	148	F004Z010001
167	F003H41A033	167	F003L41D033	154	F004B36A05601	146	F004D41A030	148	F004Z010006
167	F003H41B006	166	F003Z010000	154	F004B37A05602	146	F004D41A033	148	F004Z010012
167	F003H41B018	152	F0						

Page	Reference	Page	Reference	Page	Reference	Page	Reference	Page	Reference
148	F004Z040033	193	F010B22B001	193	F010B42B001	194	F010C42D001	192	F010J31A001
148	F004Z060000	193	F010B22B006	193	F010B42B006	194	F010C42D006	192	F010J31A006
148	F004Z070000	193	F010B22B012	193	F010B42B012	194	F010C42D012	192	F010J31A012
148	F004Z0A0071	193	F010B22B018	193	F010B42B018	194	F010C42D018	192	F010J31A018
148	F004Z0B0000	193	F010B22B030	193	F010B42B030	194	F010C42D030	192	F010J31A030
148	F004Z0C0000	193	F010B22B033	193	F010B42B033	194	F010C42D033	192	F010J31A033
148	F004Z0D0071	193	F010B22D001	193	F010B42D001	192	F010H21A001	192	F010J31B001
148	F004Z0E0071	193	F010B22D006	193	F010B42D006	192	F010H21A006	192	F010J31B006
148	F004Z0F0071	193	F010B22D012	193	F010B42D012	192	F010H21A012	192	F010J31B012
148	F004Z0H0000	193	F010B22D018	193	F010B42D018	192	F010H21A018	192	F010J31B018
153	F004Z0J0000	193	F010B22D030	193	F010B42D030	192	F010H21A030	192	F010J31B030
155	F004Z0K0000	193	F010B22D033	193	F010B42D033	192	F010H21A033	192	F010J31B033
148	F004Z0L0000	193	F010B31A001	194	F010C22A001	192	F010H21B001	192	F010J31D001
253	F0056030	193	F010B31A006	194	F010C22A006	192	F010H21B006	192	F010J31D006
253	F0057000	193	F010B31A012	194	F010C22A012	192	F010H21B012	192	F010J31D012
253	F0058000	193	F010B31A018	194	F010C22A018	192	F010H21B018	192	F010J31D018
252	F0070030	193	F010B31A030	194	F010C22A030	192	F010H21B030	192	F010J31D030
252	F0070054	193	F010B31A033	194	F010C22A033	192	F010H21B033	192	F010J31D033
252	F0071030	193	F010B31B001	194	F010C22B001	192	F010H31A001	192	F010J41A001
252	F0071054	193	F010B31B006	194	F010C22B006	192	F010H31A006	192	F010J41A006
253	F0072030	193	F010B31B012	194	F010C22B012	192	F010H31A012	192	F010J41A012
253	F0072054	193	F010B31B018	194	F010C22B018	192	F010H31A018	192	F010J41A018
253	F0074000	193	F010B31B030	194	F010C22B030	192	F010H31A030	192	F010J41A030
253	F0074071	193	F010B31B033	194	F010C22B033	192	F010H31A033	192	F010J41A033
190	F010A20H001	193	F010B32A001	194	F010C22D001	192	F010H31B001	192	F010J41B001
190	F010A20H006	193	F010B32A006	194	F010C22D006	192	F010H31B006	192	F010J41B006
190	F010A20H012	193	F010B32A012	194	F010C22D012	192	F010H31B012	192	F010J41B012
190	F010A20H018	193	F010B32A018	194	F010C22D018	192	F010H31B018	192	F010J41B018
190	F010A20H030	193	F010B32A030	194	F010C22D030	192	F010H31B030	192	F010J41B030
190	F010A20H033	193	F010B32A033	194	F010C22D033	192	F010H31B033	192	F010J41B033
190	F010A30H001	193	F010B32B001	194	F010C32A001	192	F010H41A001	192	F010J41D001
190	F010A30H006	193	F010B32B006	194	F010C32A006	192	F010H41A006	192	F010J41D006
190	F010A30H012	193	F010B32B012	194	F010C32A012	192	F010H41A012	192	F010J41D012
190	F010A30H018	193	F010B32B018	194	F010C32A018	192	F010H41A018	192	F010J41D018
190	F010A30H030	193	F010B32B030	194	F010C32A030	192	F010H41A030	192	F010J41D030
190	F010A30H033	193	F010B32B033	194	F010C32A033	192	F010H41A033	192	F010J41D033
190	F010A40H001	193	F010B32D001	194	F010C32B001	192	F010H41B001	96	F011A21F018
190	F010A40H006	193	F010B32D006	194	F010C32B006	192	F010H41B006	96	F011A22F030
190	F010A40H012	193	F010B32D012	194	F010C32B012	192	F010H41B012	96	F011A22F037
190	F010A40H018	193	F010B32D018	194	F010C32B018	192	F010H41B018	96	F011A23F059
190	F010A40H030	193	F010B32D030	194	F010C32B030	192	F010H41B030	96	F011A24F055
190	F010A40H033	193	F010B32D033	194	F010C32B033	192	F010H41B033	96	F011A31F018
193	F010B21A001	193	F010B41A001	194	F010C32D001	192	F010J21A001	96	F011A32F030
193	F010B21A006	193	F010B41A006	194	F010C32D006	192	F010J21A006	96	F011A32F037
193	F010B21A012	193	F010B41A012	194	F010C32D012	192	F010J21A012	96	F011A33F059
193	F010B21A018	193	F010B41A018	194	F010C32D018	192	F010J21A018	96	F011A34F055
193	F010B21A030	193	F010B41A030	194	F010C32D030	192	F010J21A030	96	F011A41F018
193	F010B21A033	193	F010B41A033	194	F010C32D033	192	F010J21A033	96	F011A42F030
193	F010B21B001	193	F010B41B001	194	F010C42A001	192	F010J21B001	96	F011A42F037
193	F010B21B006	193	F010B41B006	194	F010C42A006	192	F010J21B006	96	F011A43F059
193	F010B21B012	193	F010B41B012	194	F010C42A012	192	F010J21B012	96	F011A44F055
193	F010B21B018	193	F010B41B018	194	F010C42A018	192	F010J21B018	97	F011W20A018
193	F010B21B030	193	F010B41B030	194	F010C42A030	192	F010J21B030	97	F011W20A030
193	F010B21B033	193	F010B41B033	194	F010C42A033	192	F010J21B033	97	F011W20A037
193	F010B22A001	193	F010B42A001	194	F010C42B001	192	F010J21D001	97	F011W20A055
193	F010B22A006	193	F010B42A006	194	F010C42B006	192	F010J21D006	97	F011W20A059
193	F010B22A012	193	F010B42A012	194	F010C42B012	192	F010J21D012	97	F011W20B018
193	F010B22A018	193	F010B42A018	194	F010C42B018	192	F010J21D018	97	F011W20B030
193	F010B22A030	193	F010B42A030	194	F010C42B030	192	F010J21D030	97	F011W20B037
193	F010B22A033	193	F010B42A033	194	F010C42B033	192	F010J21D033	97	F011W20B055

Page	Reference	Page	Reference	Page	Reference	Page	Reference	Page	Reference
97	F011W20B059	72	F015A21A018	73	F015B21A001	74	F015B43A030	76	F015D22D006
97	F011W20D018	72	F015A21A030	73	F015B21A006	74	F015B43A033	76	F015D22D012
97	F011W20D030	72	F015A21A033	73	F015B21A012	75	F015C24A000	76	F015D22D018
97	F011W20D037	72	F015A22A000	73	F015B21A018	75	F015C24A001	76	F015D22D030
97	F011W20D055	72	F015A22A001	73	F015B21A030	75	F015C24A006	76	F015D22D033
97	F011W20D059	72	F015A22A006	73	F015B21A033	75	F015C24A012	79	F015D23A000
97	F011W30A018	72	F015A22A012	73	F015B22A000	75	F015C24A018	79	F015D23A001
97	F011W30A030	72	F015A22A018	73	F015B22A001	75	F015C24A030	79	F015D23A006
97	F011W30A037	72	F015A22A030	73	F015B22A006	75	F015C24A033	79	F015D23A012
97	F011W30A055	72	F015A22A033	73	F015B22A012	75	F015C34A000	79	F015D23A018
97	F011W30A059	74	F015A23A000	73	F015B22A018	75	F015C34A001	79	F015D23A030
97	F011W30B018	74	F015A23A001	73	F015B22A030	75	F015C34A006	79	F015D23A033
97	F011W30B030	74	F015A23A006	73	F015B22A033	75	F015C34A012	79	F015D23B000
97	F011W30B037	74	F015A23A012	74	F015B23A000	75	F015C34A018	79	F015D23B001
97	F011W30B055	74	F015A23A018	74	F015B23A001	75	F015C34A030	79	F015D23B006
97	F011W30B059	74	F015A23A030	74	F015B23A006	75	F015C34A033	79	F015D23B012
97	F011W30D018	74	F015A23A033	74	F015B23A012	75	F015C44A000	79	F015D23B018
97	F011W30D030	72	F015A31A000	74	F015B23A018	75	F015C44A001	79	F015D23B030
97	F011W30D037	72	F015A31A001	74	F015B23A030	75	F015C44A006	79	F015D23B033
97	F011W30D055	72	F015A31A006	74	F015B23A033	75	F015C44A012	79	F015D23D000
97	F011W30D059	72	F015A31A012	73	F015B31A000	75	F015C44A018	79	F015D23D001
97	F011W40A018	72	F015A31A018	73	F015B31A001	75	F015C44A030	79	F015D23D006
97	F011W40A030	72	F015A31A030	73	F015B31A006	75	F015C44A033	79	F015D23D012
97	F011W40A037	72	F015A31A033	73	F015B31A012	75	F015D21A000	79	F015D23D018
97	F011W40A055	72	F015A32A000	73	F015B31A018	75	F015D21A001	79	F015D23D030
97	F011W40A059	72	F015A32A001	73	F015B31A030	75	F015D21A006	79	F015D23D033
97	F011W40B018	72	F015A32A006	73	F015B31A033	75	F015D21A012	75	F015D31A000
97	F011W40B030	72	F015A32A012	73	F015B32A000	75	F015D21A018	75	F015D31A001
97	F011W40B037	72	F015A32A018	73	F015B32A001	75	F015D21A030	75	F015D31A006
97	F011W40B055	72	F015A32A030	73	F015B32A006	75	F015D21A033	75	F015D31A012
97	F011W40B059	72	F015A32A033	73	F015B32A012	75	F015D21B000	75	F015D31A018
97	F011W40D018	74	F015A33A000	73	F015B32A018	75	F015D21B001	75	F015D31A030
97	F011W40D030	74	F015A33A001	73	F015B32A030	75	F015D21B006	75	F015D31A033
97	F011W40D037	74	F015A33A006	73	F015B32A033	75	F015D21B012	75	F015D31B000
97	F011W40D055	74	F015A33A012	74	F015B33A000	75	F015D21B018	75	F015D31B001
97	F011W40D059	74	F015A33A018	74	F015B33A001	75	F015D21B030	75	F015D31B006
105	F012A01C018	74	F015A33A030	74	F015B33A006	75	F015D21B033	75	F015D31B012
105	F012A02C030	74	F015A33A033	74	F015B33A012	75	F015D21D000	75	F015D31B018
105	F012A02C037	72	F015A41A000	74	F015B33A018	75	F015D21D001	75	F015D31B030
105	F012A03C059	72	F015A41A001	74	F015B33A030	75	F015D21D006	75	F015D31B033
105	F012A04C055	72	F015A41A006	74	F015B33A033	75	F015D21D012	75	F015D31D000
105	F012B01C018	72	F015A41A012	73	F015B41A000	75	F015D21D018	75	F015D31D001
105	F012B02C030	72	F015A41A018	73	F015B41A001	75	F015D21D030	75	F015D31D006
105	F012B02C037	72	F015A41A030	73	F01				

Page	Reference	Page	Reference	Page	Reference	Page	Reference	Page	Reference
76	F015D32B033	76	F015D42B012	78	F015E22B000	78	F015E32A018	78	F015E42A001
76	F015D32D000	76	F015D42B018	78	F015E22B001	78	F015E32A030	78	F015E42A006
76	F015D32D001	76	F015D42B030	78	F015E22B006	78	F015E32A033	78	F015E42A012
76	F015D32D006	76	F015D42B033	78	F015E22B012	78	F015E32B000	78	F015E42A018
76	F015D32D012	76	F015D42D000	78	F015E22B018	78	F015E32B001	78	F015E42A030
76	F015D32D018	76	F015D42D001	78	F015E22B030	78	F015E32B006	78	F015E42A033
76	F015D32D030	76	F015D42D006	78	F015E22B033	78	F015E32B012	78	F015E42B000
76	F015D32D033	76	F015D42D012	78	F015E22D000	78	F015E32B018	78	F015E42B001
79	F015D33A000	76	F015D42D018	78	F015E22D001	78	F015E32B030	78	F015E42B006
79	F015D33A001	76	F015D42D030	78	F015E22D006	78	F015E32B033	78	F015E42B012
79	F015D33A006	76	F015D42D033	78	F015E22D012	78	F015E32D000	78	F015E42B018
79	F015D33A012	79	F015D43A000	78	F015E22D018	78	F015E32D001	78	F015E42B030
79	F015D33A018	79	F015D43A001	78	F015E22D030	78	F015E32D006	78	F015E42B033
79	F015D33A030	79	F015D43A006	78	F015E22D033	78	F015E32D012	78	F015E42D000
79	F015D33A033	79	F015D43A012	80	F015E23A000	78	F015E32D018	78	F015E42D001
79	F015D33B000	79	F015D43A018	80	F015E23A001	78	F015E32D030	78	F015E42D006
79	F015D33B001	79	F015D43A030	80	F015E23A006	78	F015E32D033	78	F015E42D012
79	F015D33B006	79	F015D43A033	80	F015E23A012	80	F015E33A000	78	F015E42D018
79	F015D33B012	79	F015D43B000	80	F015E23A018	80	F015E33A001	78	F015E42D030
79	F015D33B018	79	F015D43B001	80	F015E23A030	80	F015E33A006	78	F015E42D033
79	F015D33B030	79	F015D43B006	80	F015E23A033	80	F015E33A012	80	F015E43A000
79	F015D33B033	79	F015D43B012	80	F015E23B000	80	F015E33A018	80	F015E43A001
79	F015D33D000	79	F015D43B018	80	F015E23B001	80	F015E33A030	80	F015E43A006
79	F015D33D001	79	F015D43B030	80	F015E23B006	80	F015E33A033	80	F015E43A012
79	F015D33D006	79	F015D43B033	80	F015E23B012	80	F015E33B000	80	F015E43A018
79	F015D33D012	79	F015D43D000	80	F015E23B018	80	F015E33B001	80	F015E43A030
79	F015D33D018	79	F015D43D001	80	F015E23B030	80	F015E33B006	80	F015E43A033
79	F015D33D030	79	F015D43D006	80	F015E23B033	80	F015E33B012	80	F015E43B000
79	F015D33D033	79	F015D43D012	80	F015E23D000	80	F015E33B018	80	F015E43B001
75	F015D41A000	79	F015D43D018	80	F015E23D001	80	F015E33B030	80	F015E43B006
75	F015D41A001	79	F015D43D030	80	F015E23D006	80	F015E33B033	80	F015E43B012
75	F015D41A006	79	F015D43D033	80	F015E23D012	80	F015E33D000	80	F015E43B018
75	F015D41A012	77	F015E21A000	80	F015E23D018	80	F015E33D001	80	F015E43B030
75	F015D41A018	77	F015E21A001	80	F015E23D030	80	F015E33D006	80	F015E43B033
75	F015D41A030	77	F015E21A006	80	F015E23D033	80	F015E33D012	80	F015E43D000
75	F015D41A033	77	F015E21A012	77	F015E31A000	80	F015E33D018	80	F015E43D001
75	F015D41B000	77	F015E21A018	77	F015E31A001	80	F015E33D030	80	F015E43D006
75	F015D41B001	77	F015E21A030	77	F015E31A006	80	F015E33D033	80	F015E43D012
75	F015D41B006	77	F015E21A033	77	F015E31A012	77	F015E41A000	80	F015E43D018
75	F015D41B012	77	F015E21B000	77	F015E31A018	77	F015E41A001	80	F015E43D030
75	F015D41B018	77	F015E21B001	77	F015E31A030	77	F015E41A006	80	F015E43D033
75	F015D41B030	77	F015E21B006	77	F015E31A033	77	F015E41A012	81	F015F24A000
75	F015D41B033	77	F015E21B012	77	F015E31B000	77	F015E41A018	81	F015F24A001
75	F015D41D000	77	F015E21B018	77	F015E31B001	77	F015E41A030	81	F015F24A006
75	F015D41D001	77	F015E21B030	77	F015E31B006	77	F015E41A033	81	F015F24A012
75	F015D41D006	77	F015E21B033	77	F015E31B012	77	F015E41B000	81	F015F24A018
75	F015D41D012	77	F015E21D000	77	F015E31B018	77	F015E41B001	81	F015F24A030
75	F015D41D018	77	F015E21D001	77	F015E31B030	77	F015E41B006	81	F015F24A033
75	F015D41D030	77	F015E21D006	77	F015E31B033	77	F015E41B012	81	F015F24B000
75	F015D41D033	77	F015E21D012	77	F015E31D000	77	F015E41B018	81	F015F24B001
76	F015D42A000	77	F015E21D018	77	F015E31D001	77	F015E41B030	81	F015F24B006
76	F015D42A001	77	F015E21D030	77	F015E31D006	77	F015E41B033	81	F015F24B012
76	F015D42A006	77	F015E21D033	77	F015E31D012	77	F015E41D000	81	F015F24B018
76	F015D42A012	78	F015E22A000	77	F015E31D018	77	F015E41D001	81	F015F24B030
76	F015D42A018	78	F015E22A001	77	F015E31D030	77	F015E41D006	81	F015F24B033
76	F015D42A030	78	F015E22A006	77	F015E31D033	77	F015E41D012	81	F015F24D000
76	F015D42A033	78	F015E22A012	78	F015E32A000	77	F015E41D018	81	F015F24D001
76	F015D42B000	78	F015E22A018	78	F015E32A001	77	F015E41D030	81	F015F24D006
76	F015D42B001	78	F015E22A030	78	F015E32A006	77	F015E41D033	81	F015F24D012
76	F015D42B006	78	F015E22A033	78	F015E32A012	78	F015E42A000	81	F015F24D018

Page	Reference	Page	Reference	Page	Reference	Page	Reference	Page	Reference
81	F015F24D030	64	F015G31A030	66	F015J21A030	67	F015J32B030	68	F015K21D030
81	F015F24D033	64	F015G31A033	66	F015J21A033	67	F015J32B033	68	F015K21D033
81	F015F34A000	64	F015G32A001	66	F015J21B001	67	F015J32D001	69	F015K22A001
81	F015F34A001	64	F015G32A006	66	F015J21B006	67	F015J32D006	69	F015K22A006
81	F015F34A006	64	F015G32A012	66	F015J21B012	67	F015J32D012	69	F015K22A012
81	F015F34A012	64	F015G32A018	66	F015J21B018	67	F015J32D018	69	F015K22A018
81	F015F34A018	64	F015G32A030	66	F015J21B030	67	F015J32D030	69	F015K22A030
81	F015F34A030	64	F015G32A033	66	F015J21B033	67	F015J32D033	69	F015K22A033
81	F015F34A033	64	F015G41A001	66	F015J21D001	66	F015J41A001	69	F015K22B001
81	F015F34B000	64	F015G41A006	66	F015J21D006	66	F015J41A006	69	F015K22B006
81	F015F34B001	64	F015G41A012	66	F015J21D012	66	F015J41A012	69	F015K22B012
81	F015F34B006	64	F015G41A018	66	F015J21D018	66	F015J41A018	69	F015K22B018
81	F015F34B012	64	F015G41A030	66	F015J21D030	66	F015J41A030	69	F015K22B030
81	F015F34B018	64	F015G41A033	66	F015J21D033	66	F015J41A033	69	F015K22B033
81	F015F34B030	64	F015G42A001	67	F015J22A001	66	F015J41B001	69	F015K22D001
81	F015F34B033	64	F015G42A006	67	F015J22A006	66	F015J41B006	69	F015K22D006
81	F015F34D000	64	F015G42A012	67	F015J22A012	66	F015J41B012	69	F015K22D012
81	F015F34D001	64	F015G42A018	67	F015J22A018	66	F015J41B018	69	F015K22D018
81	F015F34D006	64	F015G42A030	67	F015J22A030	66	F015J41B030	69	F015K22D030
81	F015F34D012	64	F015G42A033	67	F015J22A033	66	F015J41B033	69	F015K22D033
81	F015F34D018	65	F015H21A001	67	F015J22B001	66	F015J41D001	68	F015K31A001
81	F015F34D030	65	F015H21A006	67	F015J22B006	66	F015J41D006	68	F015K31A006
81	F015F34D033	65	F015H21A012	67	F015J22B012	66	F015J41D012	68	F015K31A012
81	F015F44A000	65	F015H21A018	67	F015J22B018	66	F015J41D018	68	F015K31A018
81	F015F44A001	65	F015H21A030	67	F015J22B030	66	F015J41D030	68	F015K31A030
81	F015F44A006	65	F015H21A033	67	F015J22B033	66	F015J41D033	68	F015K31A033
81	F015F44A012	65	F015H22A001	67	F015J22D001	67	F015J42A001	68	F015K31B001
81	F015F44A018	65	F015H22A006	67	F015J22D006	67	F015J42A006	68	F015K31B006
81	F015F44A030	65	F015H22A012	67	F015J22D012	67	F015J42A012	68	F015K31B012
81	F015F44A033	65	F015H22A018	67	F015J22D018	67	F015J42A018	68	F015K31B018
81	F015F44B000	65	F015H22A030	67	F015J22D030	67	F015J42A030	68	F015K31B030
81	F015F44B001	65	F015H22A033	67	F015J22D033	67	F015J42A033	68	F015K31B033
81	F015F44B006	65	F015H31A001	66	F015J21A001	67	F015J42B001	68	F015K31D001
81	F015F44B012	65	F015H31A006	66	F015J31A006	67	F015J42B006	68	F015K31D006
81	F015F44B018	65	F015H31A012	66	F015J31A012	67	F015J42B012	68	F015K31D012
81	F015F44B030	65	F015H31A018	66	F015J31A018	67	F015J42B018	68	F015K31D018
81	F015F44B033	65	F015H31A030	66	F015J31A030	67	F015J42B030	68	F015K31D030
81	F015F44D000	65	F015H31A033	66	F015J31A033	67	F015J42B033	68	F015K31D033
81	F015F44D001	65	F015H32A001	66	F015J31B001	67	F015J42D001	69	F015K32A001
81	F015F44D006	65	F015H32A006	66	F015J31B006	67	F015J42D006	69	F015K32A006
81	F015F44D012	65	F015H32A012	66	F015J31B012	67	F015J42D012	69	F015K32A012
81	F015F44D018	65	F015H32A018	66	F015J31B018	67	F015J42D018	69	F015K32A018
81	F015F44D030	65	F015H32A030	66	F015J31B030	67	F015J42D030	69	F015K32A030
81	F015F44D033	65	F015H32A033	66	F015J31B033	67	F015J42D033	69	F015K32A033
64	F015G21A001	65	F015H41A001	66	F015J31D001	68	F015K21A001	69	F015K32B001
64									

Page	Reference	Page	Reference	Page	Reference	Page	Reference	Page	Reference
68	F015K41A030	71	F015M20B000	116	F016A21A012	116	F016A31B012	116	F016A41D012
68	F015K41A033	71	F015M20B001	116	F016A21A018	116	F016A31B018	116	F016A41D018
68	F015K41B001	71	F015M20B006	116	F016A21A030	116	F016A31B030	116	F016A41D030
68	F015K41B006	71	F015M20B012	116	F016A21A033	116	F016A31B033	116	F016A41D033
68	F015K41B012	71	F015M20B018	116	F016A21B001	116	F016A31D001	118	F016A42A001
68	F015K41B018	71	F015M20B030	116	F016A21B006	116	F016A31D006	118	F016A42A006
68	F015K41B030	71	F015M20B033	116	F016A21B012	116	F016A31D012	118	F016A42A012
68	F015K41B033	71	F015M20D000	116	F016A21B018	116	F016A31D018	118	F016A42A018
68	F015K41D001	71	F015M20D001	116	F016A21B030	116	F016A31D030	118	F016A42A030
68	F015K41D006	71	F015M20D006	116	F016A21B033	116	F016A31D033	118	F016A42A033
68	F015K41D012	71	F015M20D012	116	F016A21D001	118	F016A32A001	118	F016A42B001
68	F015K41D018	71	F015M20D018	116	F016A21D006	118	F016A32A006	118	F016A42B006
68	F015K41D030	71	F015M20D030	116	F016A21D012	118	F016A32A012	118	F016A42B012
68	F015K41D033	71	F015M20D033	116	F016A21D018	118	F016A32A018	118	F016A42B018
69	F015K42A001	71	F015M30A000	116	F016A21D030	118	F016A32A030	118	F016A42B030
69	F015K42A006	71	F015M30A001	116	F016A21D033	118	F016A32A033	118	F016A42B033
69	F015K42A012	71	F015M30A006	118	F016A22A001	118	F016A32B001	118	F016A42D001
69	F015K42A018	71	F015M30A012	118	F016A22A006	118	F016A32B006	118	F016A42D006
69	F015K42A030	71	F015M30A018	118	F016A22A012	118	F016A32B012	118	F016A42D012
69	F015K42A033	71	F015M30A030	118	F016A22A018	118	F016A32B018	118	F016A42D018
69	F015K42B001	71	F015M30A033	118	F016A22A030	118	F016A32B030	118	F016A42D030
69	F015K42B006	71	F015M30B000	118	F016A22A033	118	F016A32B033	118	F016A42D033
69	F015K42B012	71	F015M30B001	118	F016A22B001	118	F016A32D001	120	F016A43A001
69	F015K42B018	71	F015M30B006	118	F016A22B006	118	F016A32D006	120	F016A43A006
69	F015K42B030	71	F015M30B012	118	F016A22B012	118	F016A32D012	120	F016A43A012
69	F015K42B033	71	F015M30B018	118	F016A22B018	118	F016A32D018	120	F016A43A018
69	F015K42D001	71	F015M30B030	118	F016A22B030	118	F016A32D030	120	F016A43A030
69	F015K42D006	71	F015M30B033	118	F016A22B033	118	F016A32D033	120	F016A43A033
69	F015K42D012	71	F015M30D000	118	F016A22D001	120	F016A33A001	120	F016A43B001
69	F015K42D018	71	F015M30D001	118	F016A22D006	120	F016A33A006	120	F016A43B006
69	F015K42D030	71	F015M30D006	118	F016A22D012	120	F016A33A012	120	F016A43B012
69	F015K42D033	71	F015M30D012	118	F016A22D018	120	F016A33A018	120	F016A43B018
70	F015L20A000	71	F015M30D018	118	F016A22D030	120	F016A33A030	120	F016A43B030
70	F015L20A001	71	F015M30D030	118	F016A22D033	120	F016A33A033	120	F016A43B033
70	F015L20A006	71	F015M30D033	120	F016A23A001	120	F016A33B001	120	F016A43D001
70	F015L20A012	71	F015M40A000	120	F016A23A006	120	F016A33B006	120	F016A43D006
70	F015L20A018	71	F015M40A001	120	F016A23A012	120	F016A33B012	120	F016A43D012
70	F015L20A030	71	F015M40A006	120	F016A23A018	120	F016A33B018	120	F016A43D018
70	F015L20A033	71	F015M40A012	120	F016A23A030	120	F016A33B030	120	F016A43D030
70	F015L30A000	71	F015M40A018	120	F016A23A033	120	F016A33B033	120	F016A43D033
70	F015L30A001	71	F015M40A030	120	F016A23B001	120	F016A33D001	117	F016B21A001
70	F015L30A006	71	F015M40A033	120	F016A23B006	120	F016A33D006	117	F016B21A006
70	F015L30A012	71	F015M40B000	120	F016A23B012	120	F016A33D012	117	F016B21A012
70	F015L30A018	71	F015M40B001	120	F016A23B018	120	F016A33D018	117	F016B21A018
70	F015L30A030	71	F015M40B006	120	F016A23B030	120	F016A33D030	117	F016B21A030
70	F015L30A033	71	F015M40B012	120	F016A23B033	120	F016A33D033	117	F016B21A033
70	F015L40A000	71	F015M40B018	120	F016A23D001	116	F016A41A001	117	F016B21B001
70	F015L40A001	71	F015M40B030	120	F016A23D006	116	F016A41A006	117	F016B21B006
70	F015L40A006	71	F015M40B033	120	F016A23D012	116	F016A41A012	117	F016B21B012
70	F015L40A012	71	F015M40D000	120	F016A23D018	116	F016A41A018	117	F016B21B018
70	F015L40A018	71	F015M40D001	120	F016A23D030	116	F016A41A030	117	F016B21B030
70	F015L40A030	71	F015M40D006	120	F016A23D033	116	F016A41A033	117	F016B21B033
70	F015L40A033	71	F015M40D012	116	F016A31A001	116	F016A41B001	117	F016B21D001
71	F015M20A000	71	F015M40D018	116	F016A31A006	116	F016A41B006	117	F016B21D006
71	F015M20A001	71	F015M40D030	116	F016A31A012	116	F016A41B012	117	F016B21D012
71	F015M20A006	71	F015M40D033	116	F016A31A018	116	F016A41B018	117	F016B21D018
71	F015M20A012	69	F015Z000000	116	F016A31A030	116	F016A41B030	117	F016B21D030
71	F015M20A018	69	F015Z010000	116	F016A31A033	116	F016A41B033	117	F016B21D033
71	F015M20A030	116	F016A21A001	116	F016A31B001	116	F016A41D001	119	F016B22A001
71	F015M20A033	116	F016A21A006	116	F016A31B006	116	F016A41D006	119	F016B22A006

Page	Reference	Page	Reference	Page	Reference	Page	Reference	Page	Reference
119	F016B22A012	119	F016B32B012	119	F016B42D012	113	F016M32K012	113	F016N22K012
119	F016B22A018	119	F016B32B018	119	F016B42D018	113	F016M32K018	113	F016N22K018
119	F016B22A030	119	F016B32B030	119	F016B42D030	113	F016M32K030	113	F016N22K030
119	F016B22A033	119	F016B32B033	119	F016B42D033	113	F016M32K033	113	F016N22K033
119	F016B22B001	119	F016B32D001	121	F016B43A001	114	F016M33K001	114	F016N23K001
119	F016B22B006	119	F016B32D006	121	F016B43A006	114	F016M33K006	114	F016N23K006
119	F016B22B012	119	F016B32D012	121	F016B43A012	114	F016M33K012	114	F016N23K012
119	F016B22B018	119	F016B32D018	121	F016B43A018	114	F016M33K018	114	F016N23K018
119	F016B22B030	119	F016B32D030	121	F016B43A030	114	F016M33K030	114	F016N23K030
119	F016B22B033	119	F016B32D033	121	F016B43A033	114	F016M33K033	114	F016N23K033
119	F016B22D001	121	F016B33A001	121	F016B43B001	115	F016M34K001	112	F016N31K001
119	F016B22D006	121	F016B33A006	121	F016B43B006	115	F016M34K006	112	F016N31K006
119	F016B22D012	121	F016B33A012	121	F016B43B012	115	F016M34K012	112	F016N31K012
119	F016B22D018	121	F016B33A018	121	F016B43B018	115	F016M34K018	112	F016N31K018
119	F016B22D030	121	F016B33A030	121	F016B43B030	115	F016M34K030	112	F016N31K030
119	F016B22D033	121	F016B33A033	121	F016B43B033	115	F016M34K033	112	F016N31K033
121	F016B23A001	121	F016B33B001	121	F016B43D001	115	F016M35K001	113	F016N32K001
121	F016B23A006	121	F016B33B006	121	F016B43D006	115	F016M35K006	113	F016N32K006
121	F016B23A012	121	F016B33B012	121	F016B43D012	115	F016M35K012	113	F016N32K012
121	F016B23A018	121	F016B33B018	121	F016B43D018	115	F016M35K018	113	F016N32K018
121	F016B23A030	121	F016B33B030	121	F016B43D030	115	F016M35K030	113	F016N32K030
121	F016B23A033	121	F016B33B033	121	F016B43D033	115	F016M35K033	113	F016N32K033
121	F016B23B001	121	F016B33D001	112	F016M21K001	112	F016M41K001	114	F016N33K001
121	F016B23B006	121	F016B33D006	112	F016M21K006	112	F016M41K006	114	F016N33K006
121	F016B23B012	121	F016B33D012	112	F016M21K012	112	F016M41K012	114	F016N33K012
121	F016B23B018	121	F016B33D018	112	F016M21K018	112	F016M41K018	114	F016N33K018
121	F016B23B030	121	F016B33D030	112	F016M21K030	112	F016M41K030	114	F016N33K030
121	F016B23B033	121	F016B33D033	112	F016M21K033	112	F016M41K033	114	F016N33K033
121	F016B23D001	117	F016B41A001	113	F016M22K001	113	F016M42K001	112	F016N41K001
121	F016B23D006	117	F016B41A006	113	F016M22K006	113	F016M42K006	112	F016N41K006
121	F016B23D012	117	F016B41A012	113	F016M22K012	113	F016M42K012	112	F016N41K012
121	F016B23D018	117	F016B41A018	113	F016M22K018	113	F016M42K018	112	F016N41K018
121	F016B23D030	117	F016B41A030	113	F016M22K030	113	F016M42K030	112	F016N41K030
121	F016B23D033	117	F016B41A033	113	F016M22K033	113	F016M42K033	112	F016N41K033
117	F016B31A001	117	F016B41B001	114	F016M23K001	114	F016M43K001	113	F016N42K001
117	F016B31A006	117	F016B41B006	114	F016M23K006	114	F016M43K006	113	F016N42K006
117	F016B31A012	117	F016B41B012	114	F016M23K012	114	F016M43K012	113	F016N42K012
117	F016B31A018	117	F016B41B018	114	F016M23K018	114	F016M43K018	113	F016N42K018
117	F016B31A030	117	F016B41B030	114	F016M23K030	114	F016M43K030	113	F016N42K030
117	F016B31A033	117	F016B41B033	114	F016M23K033	114	F016M43K033	113	F016N42K033
117	F016B31B001	117	F016B41D001	115	F016M24K001	115	F016M44K001	114	F016N43K001
117	F016B31B006	117	F016B41D006	115	F016M24K006	115	F016M44K006	114	F016N43K006
117	F016B31B012	117</							

Page	Reference	Page	Reference	Page	Reference	Page	Reference	Page	Reference
52	F018A21B033	52	F018A31B018	54	F018B22B001	54	F018C35A025	52	F018E21K012
52	F018A21D001	52	F018A31B025	54	F018B22B012	54	F018C35A030	52	F018E21K013
52	F018A21D012	52	F018A31B030	54	F018B22B013	54	F018C35A033	52	F018E21K018
52	F018A21D013	52	F018A31B033	54	F018B22B018	54	F018C35B001	52	F018E21K025
52	F018A21D018	52	F018A31D001	54	F018B22B025	54	F018C35B012	52	F018E21K030
52	F018A21D025	52	F018A31D012	54	F018B22B030	54	F018C35B013	52	F018E21K033
52	F018A21D030	52	F018A31D013	54	F018B22B033	54	F018C35B018	52	F018E31K001
52	F018A21D033	52	F018A31D018	54	F018B22D001	54	F018C35B025	52	F018E31K012
53	F018A22A001	52	F018A31D025	54	F018B22D012	54	F018C35B030	52	F018E31K013
53	F018A22A012	52	F018A31D030	54	F018B22D013	54	F018C35B033	52	F018E31K018
53	F018A22A013	52	F018A31D033	54	F018B22D018	54	F018C35D001	52	F018E31K025
53	F018A22A018	53	F018A32A001	54	F018B22D025	54	F018C35D012	52	F018E31K030
53	F018A22A025	53	F018A32A012	54	F018B22D030	54	F018C35D013	52	F018E31K033
53	F018A22A030	53	F018A32A013	54	F018B22D033	54	F018C35D018	55	F018Z000000
53	F018A22A033	53	F018A32A018	54	F018B32A001	54	F018C35D025	128	F019A21D001
53	F018A22B001	53	F018A32A025	54	F018B32A012	54	F018C35D030	128	F019A21D006
53	F018A22B012	53	F018A32A030	54	F018B32A013	54	F018C35D033	128	F019A21D012
53	F018A22B013	53	F018A32A033	54	F018B32A018	55	F018D25A001	128	F019A21D018
53	F018A22B018	53	F018A32B001	54	F018B32A025	55	F018D25A012	128	F019A21D030
53	F018A22B025	53	F018A32B012	54	F018B32A030	55	F018D25A013	128	F019A21D033
53	F018A22B030	53	F018A32B013	54	F018B32A033	55	F018D25A018	128	F019A22D001
53	F018A22B033	53	F018A32B018	54	F018B32B001	55	F018D25A025	128	F019A22D006
53	F018A22D001	53	F018A32B025	54	F018B32B012	55	F018D25A030	128	F019A22D012
53	F018A22D012	53	F018A32B030	54	F018B32B013	55	F018D25A033	128	F019A22D018
53	F018A22D013	53	F018A32B033	54	F018B32B018	55	F018D25B001	128	F019A22D030
53	F018A22D018	53	F018A32D001	54	F018B32B025	55	F018D25B012	128	F019A22D033
53	F018A22D025	53	F018A32D012	54	F018B32B030	55	F018D25B013	130	F019A23D001
53	F018A22D030	53	F018A32D013	54	F018B32B033	55	F018D25B018	130	F019A23D006
53	F018A22D033	53	F018A32D018	54	F018B32D001	55	F018D25B025	130	F019A23D012
53	F018A23A001	53	F018A32D025	54	F018B32D012	55	F018D25B030	130	F019A23D018
53	F018A23A012	53	F018A32D030	54	F018B32D013	55	F018D25B033	130	F019A23D030
53	F018A23A013	53	F018A32D033	54	F018B32D018	55	F018D25D001	130	F019A23D033
53	F018A23A018	53	F018A33A001	54	F018B32D025	55	F018D25D012	128	F019A31D001
53	F018A23A025	53	F018A33A012	54	F018B32D030	55	F018D25D013	128	F019A31D006
53	F018A23A030	53	F018A33A013	54	F018B32D033	55	F018D25D018	128	F019A31D012
53	F018A23A033	53	F018A33A018	54	F018C25A001	55	F018D25D025	128	F019A31D018
53	F018A23B001	53	F018A33A025	54	F018C25A012	55	F018D25D030	128	F019A31D030
53	F018A23B012	53	F018A33A030	54	F018C25A013	55	F018D25D033	128	F019A31D033
53	F018A23B013	53	F018A33A033	54	F018C25A018	55	F018D35A001	128	F019A32D001
53	F018A23B018	53	F018A33B001	54	F018C25A025	55	F018D35A012	128	F019A32D006
53	F018A23B025	53	F018A33B012	54	F018C25A030	55	F018D35A013	128	F019A32D012
53	F018A23B030	53	F018A33B013	54	F018C25A033	55	F018D35A018	128	F019A32D018
53	F018A23B033	53	F018A33B018	54	F018C25B001	55	F018D35A025	128	F019A32D030
53	F018A23D001	53	F018A33B025	54	F018C25B012	55	F018D35A030	128	F019A32D033
53	F018A23D012	53	F018A33B030	54	F018C25B013	55	F018D35A033	130	F019A33D001
53	F018A23D013	53	F018A33B033	54	F018C25B018	55	F018D35B001	130	F019A33D006
53	F018A23D018	53	F018A33D001	54	F018C25B025	55	F018D35B012	130	F019A33D012
53	F018A23D025	53	F018A33D012	54	F018C25B030	55	F018D35B013	130	F019A33D018
53	F018A23D030	53	F018A33D013	54	F018C25B033	55	F018D35B018	130	F019A33D030
53	F018A23D033	53	F018A33D018	54	F018C25D001	55	F018D35B025	130	F019A33D033
52	F018A31A001	53	F018A33D025	54	F018C25D012	55	F018D35B030	128	F019A41D001
52	F018A31A012	53	F018A33D030	54	F018C25D013	55	F018D35B033	128	F019A41D006
52	F018A31A013	53	F018A33D033	54	F018C25D018	55	F018D35D001	128	F019A41D012
52	F018A31A018	54	F018B22A001	54	F018C25D025	55	F018D35D012	128	F019A41D018
52	F018A31A025	54	F018B22A012	54	F018C25D030	55	F018D35D013	128	F019A41D030
52	F018A31A030	54	F018B22A013	54	F018C25D033	55	F018D35D018	128	F019A41D033
52	F018A31A033	54	F018B22A018	54	F018C35A001	55	F018D35D025	128	F019A42D001
52	F018A31B001	54	F018B22A025	54	F018C35A012	55	F018D35D030	128	F019A42D006
52	F018A31B012	54	F018B22A030	54	F018C35A013	55	F018D35D033	128	F019A42D012
52	F018A31B013	54	F018B22A033	54	F018C35A018	52	F018E21K001	128	F019A42D018

Page	Reference	Page	Reference	Page	Reference	Page	Reference	Page	Reference
128	F019A42D030	131	F019B43D030	425	F020A2BH030	429	F020A2MH030	425	F020A3BH030
128	F019A42D033	131	F019B43D033	425	F020A2BH033	429	F020A2MH033	425	F020A3BH033
130	F019A43D001	422	F020A21H001	427	F020A2CH001	422	F020A31H001	427	F020A3CH001
130	F019A43D006	422	F020A21H006	427	F020A2CH006	422	F020A31H006	427	F020A3CH006
130	F019A43D012	422	F020A21H012	427	F020A2CH012	422	F020A31H012	427	F020A3CH012
130	F019A43D018	422	F020A21H018	427	F020A2CH018	422	F020A31H018	427	F020A3CH018
130	F019A43D030	422	F020A21H030	427	F020A2CH030	422	F020A31H030	427	F020A3CH030
130	F019A43D033	422	F020A21H033	427	F020A2CH033	422	F020A31H033	427	F020A3CH033
129	F019B21D001	424	F020A22H001	429	F020A2DH001	424	F020A32H001	429	F020A3DH001
129	F019B21D006	424	F020A22H006	429	F020A2DH006	424	F020A32H006	429	F020A3DH006
129	F019B21D012	424	F020A22H012	429	F020A2DH012	424	F020A32H012	429	F020A3DH012
129	F019B21D018	424	F020A22H018	429	F020A2DH018	424	F020A32H018	429	F020A3DH018
129	F019B21D030	424	F020A22H030	429	F020A2DH030	424	F020A32H030	429	F020A3DH030
129	F019B21D033	424	F020A22H033	429	F020A2DH033	424	F020A32H033	429	F020A3DH033
129	F019B22D001	426	F020A23H001	423	F020A2EH001	426	F020A33H001	423	F020A3EH001
129	F019B22D006	426	F020A23H006	423	F020A2EH006	426	F020A33H006	423	F020A3EH006
129	F019B22D012	426	F020A23H012	423	F020A2EH012	426	F020A33H012	423	F020A3EH012
129	F019B22D018	426	F020A23H018	423	F020A2EH018	426	F020A33H018	423	F020A3EH018
129	F019B22D030	426	F020A23H030	423	F020A2EH030	426	F020A33H030	423	F020A3EH030
129	F019B22D033	426	F020A23H033	423	F020A2EH033	426	F020A33H033	423	F020A3EH033
131	F019B23D001	428	F020A24H001	425	F020A2FH001	428	F020A34H001	425	F020A3FH001
131	F019B23D006	428	F020A24H006	425	F020A2FH006	428	F020A34H006	425	F020A3FH006
131	F019B23D012	428	F020A24H012	425	F020A2FH012	428	F020A34H012	425	F020A3FH012
131	F019B23D018	428	F020A24H018	425	F020A2FH018	428	F020A34H018	425	F020A3FH018
131	F019B23D030	428	F020A24H030	425	F020A2FH030	428	F020A34H030	425	F020A3FH030
131	F019B23D033	428	F020A24H033	425	F020A2FH033	428	F020A34H033	425	F020A3FH033
129	F019B31D001	422	F020A25H001	427	F020A2GH001	422	F020A35H001	427	F020A3GH001
129	F019B31D006	422	F020A25H006	427	F020A2GH006	422	F020A35H006	427	F020A3GH006
129	F019B31D012	422	F020A25H012	427	F020A2GH012	422	F020A35H012	427	F020A3GH012
129	F019B31D018	422	F020A25H018	427	F020A2GH018	422	F020A35H018	427	F020A3GH018
129	F019B31D030	422	F020A25H030	427	F020A2GH030	422	F020A35H030	427	F020A3GH030
129	F019B31D033	422	F020A25H033	427	F020A2GH033	422	F020A35H033	427	F020A3GH033
129	F019B32D001	424	F020A26H001	429	F020A2HH001	424	F020A36H001	429	F020A3HH001
129	F019B32D006	424	F020A26H006	429	F020A2HH006	424	F020A36H006	429	F020A3HH006
129	F019B32D012	424	F020A26H012	429	F020A2HH012	424	F020A36H012	429	F020A3HH012
129	F019B32D018	424	F020A26H018	429	F020A2HH018	424	F020A36H018	429	F020A3HH018
129	F019B32D030	424	F020A26H030	429	F020A2HH030	424	F020A36H030	429	F020A3HH030
129	F019B32D033	424	F020A26H033	429	F020A2HH033	424	F020A36H033	429	F020A3HH033
131	F019B33D001	426	F020A27H001	423	F020A2JH001	426	F020A37H001	423	F020A3JH001
131	F019B33D006	426	F020A27H006	423	F020A2JH006	426	F020A37H006	423	F020A3JH006
131	F019B33D012	426	F020A27H012	423	F020A2JH012	426	F020A37H012	423	F020A3JH012
131	F019B33D018	426	F020A27H018	423	F020A2JH018	426	F020A37H018	423	F020A3JH018
131	F019B33D030	426	F020A27H030	423	F020A2JH030	426	F020A37H030	423	F020A3JH030
131	F019B33D033	426	F020A27H033	423	F020A2JH033	426	F020A37H033	423	F020A3JH033
1									

Page	Reference	Page	Reference	Page	Reference	Page	Reference	Page	Reference
450	F021C44D030	448	F021C4CD030	447	F021C4KD030	455	F021G2MA030	454	F021G4KA030
450	F021C44D033	448	F021C4CD033	447	F021C4KD033	455	F021G2MA033	454	F021G4KA033
440	F021C46A001	445	F021C4DA001	443	F021C4LA001	457	F021G2MD001	456	F021G4KD001
440	F021C46A006	445	F021C4DA006	443	F021C4LA006	457	F021G2MD006	456	F021G4KD006
440	F021C46A012	445	F021C4DA012	443	F021C4LA012	457	F021G2MD012	456	F021G4KD012
440	F021C46A018	445	F021C4DA018	443	F021C4LA018	457	F021G2MD018	456	F021G4KD018
440	F021C46A030	445	F021C4DA030	443	F021C4LA030	457	F021G2MD030	456	F021G4KD030
440	F021C46A033	445	F021C4DA033	443	F021C4LA033	457	F021G2MD033	456	F021G4KD033
446	F021C46D001	450	F021C4DD001	449	F021C4LD001	454	F021G3JA001	455	F021G4LA001
446	F021C46D006	450	F021C4DD006	449	F021C4LD006	454	F021G3JA006	455	F021G4LA006
446	F021C46D012	450	F021C4DD012	449	F021C4LD012	454	F021G3JA012	455	F021G4LA012
446	F021C46D018	450	F021C4DD018	449	F021C4LD018	454	F021G3JA018	455	F021G4LA018
446	F021C46D030	450	F021C4DD030	449	F021C4LD030	454	F021G3JA030	455	F021G4LA030
446	F021C46D033	450	F021C4DD033	449	F021C4LD033	454	F021G3JA033	455	F021G4LA033
442	F021C47A001	441	F021C4FA001	445	F021C4MA001	454	F021G3KA001	456	F021G4LD001
442	F021C47A006	441	F021C4FA006	445	F021C4MA006	454	F021G3KA006	456	F021G4LD006
442	F021C47A012	441	F021C4FA012	445	F021C4MA012	454	F021G3KA012	456	F021G4LD012
442	F021C47A018	441	F021C4FA018	445	F021C4MA018	454	F021G3KA018	456	F021G4LD018
442	F021C47A030	441	F021C4FA030	445	F021C4MA030	454	F021G3KA030	456	F021G4LD030
442	F021C47A033	441	F021C4FA033	445	F021C4MA033	454	F021G3KA033	456	F021G4LD033
448	F021C47D001	447	F021C4FD001	451	F021C4MD001	456	F021G3KD001	455	F021G4MA001
448	F021C47D006	447	F021C4FD006	451	F021C4MD006	456	F021G3KD006	455	F021G4MA006
448	F021C47D012	447	F021C4FD012	451	F021C4MD012	456	F021G3KD012	455	F021G4MA012
448	F021C47D018	447	F021C4FD018	451	F021C4MD018	456	F021G3KD018	455	F021G4MA018
448	F021C47D030	447	F021C4FD030	451	F021C4MD030	456	F021G3KD030	455	F021G4MA030
448	F021C47D033	447	F021C4FD033	451	F021C4MD033	456	F021G3KD033	455	F021G4MA033
444	F021C48A001	443	F021C4GA001	454	F021G2JA001	455	F021G3LA001	457	F021G4MD001
444	F021C48A006	443	F021C4GA006	454	F021G2JA006	455	F021G3LA006	457	F021G4MD006
444	F021C48A012	443	F021C4GA012	454	F021G2JA012	455	F021G3LA012	457	F021G4MD012
444	F021C48A018	443	F021C4GA018	454	F021G2JA018	455	F021G3LA018	457	F021G4MD018
444	F021C48A030	443	F021C4GA030	454	F021G2JA030	455	F021G3LA030	457	F021G4MD030
444	F021C48A033	443	F021C4GA033	454	F021G2JA033	455	F021G3LA033	457	F021G4MD033
450	F021C48D001	449	F021C4GD001	454	F021G2KA001	456	F021G3LD001	454	F021H2JA001
450	F021C48D006	449	F021C4GD006	454	F021G2KA006	456	F021G3LD006	454	F021H2JA006
450	F021C48D012	449	F021C4GD012	454	F021G2KA012	456	F021G3LD012	454	F021H2JA012
450	F021C48D018	449	F021C4GD018	454	F021G2KA018	456	F021G3LD018	454	F021H2JA018
450	F021C48D030	449	F021C4GD030	454	F021G2KA030	456	F021G3LD030	454	F021H2JA030
450	F021C48D033	449	F021C4GD033	454	F021G2KA033	456	F021G3LD033	454	F021H2JA033
441	F021C4BA001	445	F021C4HA001	456	F021G2KD001	455	F021G3MA001	454	F021H2KA001
441	F021C4BA006	445	F021C4HA006	456	F021G2KD006	455	F021G3MA006	454	F021H2KA006
441	F021C4BA012	445	F021C4HA012	456	F021G2KD012	455	F021G3MA012	454	F021H2KA012
441	F021C4BA018	445	F021C4HA018	456	F021G2KD018	455	F021G3MA018	454	F021H2KA018
441	F021C4BA030	445	F021C4HA030	456	F021G2KD030	455	F021G3MA030	454	F021H2KA030
441	F021C4BA033	445	F021C4HA033	456	F021G2KD033	455	F021G3MA033	454	F021H2KA033
446	F021C4BD001	451	F021C4HD001	455	F021G2LA001	457	F021G3MD001	455	F021H2LA001
446	F021C4BD006	451	F021C4HD006	455	F021G2LA006	457	F021G3MD006	455	F021H2LA006
446	F021C4BD012	451	F021C4HD012	455	F021G2LA012	457	F021G3MD012	455	F021H2LA012
446	F021C4BD018	451	F021C4HD018	455	F021G2LA018	457	F021G3MD018	455	F021H2LA018
446	F021C4BD030	451	F021C4HD030	455	F021G2LA030	457	F021G3MD030	455	F021H2LA030
446	F021C4BD033	451	F021C4HD033	455	F021G2LA033	457	F021G3MD033	455	F021H2LA033
443	F021C4CA001	441	F021C4KA001	456	F021G2LD001	454	F021G4JA001	455	F021H2MA001
443	F021C4CA006	441	F021C4KA006	456	F021G2LD006	454	F021G4JA006	455	F021H2MA006
443	F021C4CA012	441	F021C4KA012	456	F021G2LD012	454	F021G4JA012	455	F021H2MA012
443	F021C4CA018	441	F021C4KA018	456	F021G2LD018	454	F021G4JA018	455	F021H2MA018
443	F021C4CA030	441	F021C4KA030	456	F021G2LD030	454	F021G4JA030	455	F021H2MA030
443	F021C4CA033	441	F021C4KA033	456	F021G2LD033	454	F021G4JA033	455	F021H2MA033
448	F021C4CD001	447	F021C4KD001	455	F021G2MA001	454	F021G4KA001	454	F021H3JA001
448	F021C4CD006	447	F021C4KD006	455	F021G2MA006	454	F021G4KA006	454	F021H3JA006
448	F021C4CD012	447	F021C4KD012	455	F021G2MA012	454	F021G4KA012	454	F021H3JA012
448	F021C4CD018	447	F021C4KD018	455	F021G2MA018	454	F021G4KA018	454	F021H3JA018

Page	Reference	Page	Reference	Page	Reference	Page	Reference	Page	Reference
454	F021H3JA030	455	F021J2LA030	454	F021J4KA030	458	F021LTKD030	453	F021PTLD030
454	F021H3JA033	455	F021J2LA033	454	F021J4KA033	458	F021LTKD033	453	F021PTLD033
454	F021H3KA001	456	F021J2LD001	456	F021J4KD001	458	F021LTL001	453	F021PTMD001
454	F021H3KA006	456	F021J2LD006	456	F021J4KD006	458	F021LTL006	453	F021PTMD006
454	F021H3KA012	456	F021J2LD012	456	F021J4KD012	458	F021LTL012	453	F021PTMD012
454	F021H3KA018	456	F021J2LD018	456	F021J4KD018	458	F021LTL018	453	F021PTMD018
454	F021H3KA030	456	F021J2LD030	456	F021J4KD030	458	F021LTL030	453	F021PTMD030
454	F021H3KA033	456	F021J2LD033	456	F021J4KD033	458	F021LTL033	453	F021PTMD033
455	F021H3LA001	455	F021J2MA001	455	F021J4LA001	458	F021LTMD001	453	F021QTKD001
455	F021H3LA006	455	F021J2MA006	455	F021J4LA006	458	F021LTMD006	453	F021QTKD006
455	F021H3LA012	455	F021J2MA012	455	F021J4LA012	458	F021LTMD012	453	F021QTKD012
455	F021H3LA018	455	F021J2MA018	455	F021J4LA018	458	F021LTMD018	453	F021QTKD018
455	F021H3LA030	455	F021J2MA030	455	F021J4LA030	458	F021LTMD030	453	F021QTKD030
455	F021H3LA033	455	F021J2MA033	455	F021J4LA033	458	F021LTMD033	453	F021QTKD033
455	F021H3MA001	457	F021J2MD001	456	F021J4LD001	452	F021MRKJ001	453	F021QTL001
455	F021H3MA006	457	F021J2MD006	456	F021J4LD006	452	F021MRKJ006	453	F021QTL006
455	F021H3MA012	457	F021J2MD012	456	F021J4LD012	452	F021MRKJ012	453	F021QTL012
455	F021H3MA018	457	F021J2MD018	456	F021J4LD018	452	F021MRKJ018	453	F021QTL018
455	F021H3MA030	457	F021J2MD030	456	F021J4LD030	452	F021MRKJ030	453	F021QTL030
455	F021H3MA033	457	F021J2MD033	456	F021J4LD033	452	F021MRKJ033	453	F021QTL033
454	F021H4JA001	454	F021J3KA001	455	F021J4MA001	452	F021MRLJ001	453	F021QTMD001
454	F021H4JA006	454	F021J3KA006	455	F021J4MA006	452	F021MRLJ006	453	F021QTMD006
454	F021H4JA012	454	F021J3KA012	455	F021J4MA012	452	F021MRLJ012	453	F021QTMD012
454	F021H4JA018	454	F021J3KA018	455	F021J4MA018	452	F021MRLJ018	453	F021QTMD018
454	F021H4JA030	454	F021J3KA030	455	F021J4MA030	452	F021MRLJ030	453	F021QTMD030
454	F021H4JA033	454	F021J3KA033	455	F021J4MA033	452	F021MRLJ033	453	F021QTMD033
454	F021H4KA001	456	F021J3KD001	457	F021J4MD001	452	F021MRMJ001	434	F021Z010000
454	F021H4KA006	456	F021J3KD006	457	F021J4MD006	452	F021MRMJ006	459	F021Z020000
454	F021H4KA012	456	F021J3KD012	457	F021J4MD012	452	F021MRMJ012	459	F021Z030000
454	F021H4KA018	456	F021J3KD018	457	F021J4MD018	452	F021MRMJ018	460	F021Z040000
454	F021H4KA030	456	F021J3KD030	457	F021J4MD030	452	F021MRMJ030	460	F021Z050000
454	F021H4KA033	456	F021J3KD033	457	F021J4MD033	452	F021MRMJ033	460	F021Z060000
455	F021H4LA001	455	F021J3LA001	458	F021KTJD001	452	F021MRKJ001	434	F021Z070000
455	F021H4LA006	455	F021J3LA006	458	F021KTJD006	452	F021MRKJ006	434	F021Z090000
455	F021H4LA012	455	F021J3LA012	458	F021KTJD012	452	F021MRKJ012	434	F021Z100000
455	F021H4LA018	455	F021J3LA018	458	F021KTJD018	452	F021MRKJ018	30	F023B2AA001
455	F021H4LA030	455	F021J3LA030	458	F021KTJD030	452	F021MRKJ030	30	F023B2AA006
455	F021H4LA033	455	F021J3LA033	458	F021KTJD033	452	F021MRKJ033	30	F023B2AA012
455	F021H4MA001	456	F021J3LD001	458	F021KTKD001	452	F021MWLJ001	30	F023B2AA018
455	F021H4MA006	456	F021J3LD006	458	F021KTKD006	452	F021MWLJ006	30	F023B2AA030
455	F021H4MA012	456	F021J3LD012	458	F021KTKD012	452	F021MWLJ012	30	F023B2AA033
455	F021H4MA018	456	F021J3LD018	458	F021KTKD018	452	F021MWLJ018	30	F023B2AB001
455	F021H4MA030	456	F021J3LD030	458	F021KTKD030	452	F021MWLJ030	30	F023B2AB006
455	F021H4MA033	456	F021J3LD033	458	F021KTKD033	452	F021MWLJ033	30	F023B2AB012
454	F021J2KA001	455	F021J3MA001	458	F021KTL001	452	F021MWMJ001	30	F023B2AB018

Page	Reference	Page	Reference	Page	Reference	Page	Reference	Page	Reference
87	F030B33D000	87	F030B43B018	85	F030C23B001	85	F030C33A030	85	F030C43A006
87	F030B33D001	87	F030B43B030	85	F030C23B006	85	F030C33A033	85	F030C43A012
87	F030B33D006	87	F030B43B033	85	F030C23B012	85	F030C33B000	85	F030C43A018
87	F030B33D012	87	F030B43D000	85	F030C23B018	85	F030C33B001	85	F030C43A030
87	F030B33D018	87	F030B43D001	85	F030C23B030	85	F030C33B006	85	F030C43A033
87	F030B33D030	87	F030B43D006	85	F030C23B033	85	F030C33B012	85	F030C43B000
87	F030B33D033	87	F030B43D012	85	F030C23D000	85	F030C33B018	85	F030C43B001
86	F030B41A000	87	F030B43D018	85	F030C23D001	85	F030C33B030	85	F030C43B006
86	F030B41A001	87	F030B43D030	85	F030C23D006	85	F030C33B033	85	F030C43B012
86	F030B41A006	87	F030B43D033	85	F030C23D012	85	F030C33D000	85	F030C43B018
86	F030B41A012	84	F030C21A000	85	F030C23D018	85	F030C33D001	85	F030C43B030
86	F030B41A018	84	F030C21A001	85	F030C23D030	85	F030C33D006	85	F030C43B033
86	F030B41A030	84	F030C21A006	85	F030C23D033	85	F030C33D012	85	F030C43D000
86	F030B41A033	84	F030C21A012	84	F030C31A000	85	F030C33D018	85	F030C43D001
86	F030B41B000	84	F030C21A018	84	F030C31A001	85	F030C33D030	85	F030C43D006
86	F030B41B001	84	F030C21A030	84	F030C31A006	85	F030C33D033	85	F030C43D012
86	F030B41B006	84	F030C21A033	84	F030C31A012	84	F030C41A000	85	F030C43D018
86	F030B41B012	84	F030C21B000	84	F030C31A018	84	F030C41A001	85	F030C43D030
86	F030B41B018	84	F030C21B001	84	F030C31A030	84	F030C41A006	85	F030C43D033
86	F030B41B030	84	F030C21B006	84	F030C31A033	84	F030C41A012	88	F030D21A000
86	F030B41B033	84	F030C21B012	84	F030C31B000	84	F030C41A018	88	F030D21A001
86	F030B41D000	84	F030C21B018	84	F030C31B001	84	F030C41A030	88	F030D21A006
86	F030B41D001	84	F030C21B030	84	F030C31B006	84	F030C41A033	88	F030D21A012
86	F030B41D006	84	F030C21B033	84	F030C31B012	84	F030C41B000	88	F030D21A018
86	F030B41D012	84	F030C21D000	84	F030C31B018	84	F030C41B001	88	F030D21A030
86	F030B41D018	84	F030C21D001	84	F030C31B030	84	F030C41B006	88	F030D21A033
86	F030B41D030	84	F030C21D006	84	F030C31B033	84	F030C41B012	88	F030D21B000
86	F030B41D033	84	F030C21D012	84	F030C31D000	84	F030C41B018	88	F030D21B001
86	F030B42A000	84	F030C21D018	84	F030C31D001	84	F030C41B030	88	F030D21B006
86	F030B42A001	84	F030C21D030	84	F030C31D006	84	F030C41B033	88	F030D21B012
86	F030B42A006	84	F030C21D033	84	F030C31D012	84	F030C41D000	88	F030D21B018
86	F030B42A012	84	F030C22A000	84	F030C31D018	84	F030C41D001	88	F030D21B030
86	F030B42A018	84	F030C22A001	84	F030C31D030	84	F030C41D006	88	F030D21B033
86	F030B42A030	84	F030C22A006	84	F030C31D033	84	F030C41D012	88	F030D21D000
86	F030B42A033	84	F030C22A012	84	F030C32A000	84	F030C41D018	88	F030D21D001
86	F030B42B000	84	F030C22A018	84	F030C32A001	84	F030C41D030	88	F030D21D006
86	F030B42B001	84	F030C22A030	84	F030C32A006	84	F030C41D033	88	F030D21D012
86	F030B42B006	84	F030C22A033	84	F030C32A012	84	F030C42A000	88	F030D21D018
86	F030B42B012	84	F030C22B000	84	F030C32A018	84	F030C42A001	88	F030D21D030
86	F030B42B018	84	F030C22B001	84	F030C32A030	84	F030C42A006	88	F030D21D033
86	F030B42B030	84	F030C22B006	84	F030C32A033	84	F030C42A012	88	F030D22A000
86	F030B42B033	84	F030C22B012	84	F030C32B000	84	F030C42A018	88	F030D22A001
86	F030B42D000	84	F030C22B018	84	F030C32B001	84	F030C42A030	88	F030D22A006
86	F030B42D001	84	F030C22B030	84	F030C32B006	84	F030C42A033	88	F030D22A012
86	F030B42D006	84	F030C22B033	84	F030C32B012	84	F030C42B000	88	F030D22A018
86	F030B42D012	84	F030C22D000	84	F030C32B018	84	F030C42B001	88	F030D22A030
86	F030B42D018	84	F030C22D001	84	F030C32B030	84	F030C42B006	88	F030D22A033
86	F030B42D030	84	F030C22D006	84	F030C32B033	84	F030C42B012	88	F030D22B000
86	F030B42D033	84	F030C22D012	84	F030C32D000	84	F030C42B018	88	F030D22B001
87	F030B43A000	84	F030C22D018	84	F030C32D001	84	F030C42B030	88	F030D22B006
87	F030B43A001	84	F030C22D030	84	F030C32D006	84	F030C42B033	88	F030D22B012
87	F030B43A006	84	F030C23A000	84	F030C32D012	84	F030C42D000	88	F030D22B018
87	F030B43A012	85	F030C23A001	84	F030C32D018	84	F030C42D001	88	F030D22B030
87	F030B43A018	85	F030C23A006	84	F030C32D030	84	F030C42D006	88	F030D22B033
87	F030B43A030	85	F030C23A006	84	F030C32D033	84	F030C42D012	88	F030D22D000
87	F030B43A033	85	F030C23A012	85	F030C33A000	84	F030C42D018	88	F030D22D001
87	F030B43B000	85	F030C23A018	85	F030C33A001	84	F030C42D030	88	F030D22D006
87	F030B43B001	85	F030C23A030	85	F030C33A006	84	F030C42D033	88	F030D22D012
87	F030B43B006	85	F030C23A033	85	F030C33A012	85	F030C43A000	88	F030D22D018
87	F030B43B012	85	F030C23B000	85	F030C33A018	85	F030C43A001	88	F030D22D030

Page	Reference	Page	Reference	Page	Reference	Page	Reference	Page	Reference
88	F030D22D033	88	F030D32D012	88	F030D42D000	288	F1111030	288	F1115001
89	F030D23A000	88	F030D32D018	88	F030D42D001	288	F1111030-300	288	F1115001-300
89	F030D23A001	88	F030D32D030	88	F030D42D006	288	F1111030-310	288	F1115001-310
89	F030D23A006	88	F030D32D033	88	F030D42D012	288	F1111033	288	F1115006
89	F030D23A012	89	F030D33A000	88	F030D42D018	288	F1111033-300	288	F1115006-300
89	F030D23A018	89	F030D33A001	88	F030D42D030	288	F1111033-310	288	F1115006-310
89	F030D23A030	89	F030D33A006	88	F030D42D033	288	F1112001	288	F1115012
89	F030D23A033	89	F030D33A012	89	F030D43A000	288	F1112001-300	288	F1115012-300
89	F030D23B000	89	F030D33A018	89	F030D43A001	288	F1112001-310	288	F1115012-310
89	F030D23B001	89	F030D33A030	89	F030D43A006	288	F1112006	288	F1115018
89	F030D23B006	89	F030D33A033	89	F030D43A012	288	F1112006-300	288	F1115018-300
89	F030D23B012	89	F030D33B000	89	F030D43A018	288	F1112006-310	288	F1115018-310
89	F030D23B018	89	F030D33B001	89	F030D43A030	288	F1112012	288	F1115030
89	F030D23B030	89	F030D33B006	89	F030D43A033	288	F1112012-300	288	F1115030-300
89	F030D23B033	89	F030D33B012	89	F030D43B000	288	F1112012-310	288	F1115030-310
89	F030D23D000	89	F030D33B018	89	F030D43B001	288	F1112018	288	F1115033
89	F030D23D001	89	F030D33B030	89	F030D43B006	288	F1112018-300	288	F1115033-300
89	F030D23D006	89	F030D33B033	89	F030D43B012	288	F1112018-310	288	F1115033-310
89	F030D23D012	89	F030D33D000	89	F030D43B018	288	F1112030	289	F1116001
89	F030D23D018	89	F030D33D001	89	F030D43B030	288	F1112030-300	289	F1116001-300
89	F030D23D030	89	F030D33D006	89	F030D43B033	288	F1112030-310	289	F1116001-310
89	F030D23D033	89	F030D33D012	89	F030D43D000	288	F1112033	289	F1116006
88	F030D31A000	89	F030D33D018	89	F030D43D001	288	F1112033-300	289	F1116006-300
88	F030D31A001	89	F030D33D030	89	F030D43D006	288	F1112033-310	289	F1116006-310
88	F030D31A006	89	F030D33D033	89	F030D43D012	288	F1113001	289	F1116012
88	F030D31A012	88	F030D41A000	89	F030D43D018	288	F1113001-300	289	F1116012-300
88	F030D31A018	88	F030D41A001	89	F030D43D030	288	F1113001-310	289	F1116012-310
88	F030D31A030	88	F030D41A006	89	F030D43D033	288	F1113006	289	F1116018
88	F030D31A033	88	F030D41A012	87	F030Z010000	288	F1113006-300	289	F1116018-300
88	F030D31B000	88	F030D41A018	89	F030Z020000	288	F1113006-310	289	F1116018-310
88	F030D31B001	88	F030D41A030	288	F1110001	288	F1113012	289	F1116030
88	F030D31B006	88	F030D41A033	288	F1110001-300	288	F1113012-300	289	F1116030-300
88	F030D31B012	88	F030D41B000	288	F1110001-310	288	F1113012-310	289	F1116030-310
88	F030D31B018	88	F030D41B001	288	F1110006	288	F1113018	289	F1116033
88	F030D31B030	88	F030D41B006	288	F1110006-300	288	F1113018-300	289	F1116033-300
88	F030D31B033	88	F030D41B012	288	F1110006-310	288	F1113018-310	289	F1116033-310
88	F030D31D000	88	F030D41B018	288	F1110012	288	F1113030	289	F1117001
88	F030D31D001	88	F030D41B030	288	F1110012-300	288	F1113030-300	289	F1117001-300
88	F030D31D006	88	F030D41B033	288	F1110012-310	288	F1113030-310	289	F1117001-310
88	F030D31D012	88	F030D41D000	288	F1110018	288	F1113033	289	F1117006
88	F030D31D018	88	F030D41D001	288	F1110018-300	288	F1113033-300	289	F1117006-300
88	F030D31D030	88	F030D41D006	288	F1110018-310	288	F1113033-310	289	F1117006-310
88	F030D31D033	88	F030D41D012	288	F1110030	288	F1114001	289	F1117012
88	F030D32A000	88	F030D41D018	288	F1110030-300	288	F1114001-300	289	F1117012-300
88	F030D32A001	88	F030D41D030	288	F1110030-310	288	F1114001-310	289	F1117012-310
88									

Page	Reference	Page	Reference	Page	Reference	Page	Reference	Page	Reference
289	F1118012	289	F1121030	290	F1143001	291	F1146012	291	F1149030
289	F1118012-300	289	F1121030-300	290	F1143001-300	291	F1146012-300	291	F1149030-300
289	F1118012-310	289	F1121030-310	290	F1143001-310	291	F1146012-310	291	F1149030-310
289	F1118018	289	F1121033	290	F1143006	291	F1146018	291	F1149033
289	F1118018-300	289	F1121033-300	290	F1143006-300	291	F1146018-300	291	F1149033-300
289	F1118018-310	289	F1121033-310	290	F1143006-310	291	F1146018-310	291	F1149033-310
289	F1118030	290	F1140001	290	F1143012	291	F1146030	291	F1150001
289	F1118030-300	290	F1140001-300	290	F1143012-300	291	F1146030-300	291	F1150001-300
289	F1118030-310	290	F1140001-310	290	F1143012-310	291	F1146030-310	291	F1150001-310
289	F1118033	290	F1140006	290	F1143018	291	F1146033	291	F1150006
289	F1118033-300	290	F1140006-300	290	F1143018-300	291	F1146033-300	291	F1150006-300
289	F1118033-310	290	F1140006-310	290	F1143018-310	291	F1146033-310	291	F1150006-310
289	F1119001	290	F1140012	290	F1143030	291	F1147001	291	F1150012
289	F1119001-300	290	F1140012-300	290	F1143030-300	291	F1147001-300	291	F1150012-300
289	F1119001-310	290	F1140012-310	290	F1143030-310	291	F1147001-310	291	F1150012-310
289	F1119006	290	F1140018	290	F1143033	291	F1147006	291	F1150018
289	F1119006-300	290	F1140018-300	290	F1143033-300	291	F1147006-300	291	F1150018-300
289	F1119006-310	290	F1140018-310	290	F1143033-310	291	F1147006-310	291	F1150018-310
289	F1119012	290	F1140030	290	F1144001	291	F1147012	291	F1150030
289	F1119012-300	290	F1140030-300	290	F1144001-300	291	F1147012-300	291	F1150030-300
289	F1119012-310	290	F1140030-310	290	F1144001-310	291	F1147012-310	291	F1150030-310
289	F1119018	290	F1140033	290	F1144006	291	F1147018	291	F1150033
289	F1119018-300	290	F1140033-300	290	F1144006-300	291	F1147018-300	291	F1150033-300
289	F1119018-310	290	F1140033-310	290	F1144006-310	291	F1147018-310	291	F1150033-310
289	F1119030	290	F1141001	290	F1144012	291	F1147030	291	F1151001
289	F1119030-300	290	F1141001-300	290	F1144012-300	291	F1147030-300	291	F1151001-300
289	F1119030-310	290	F1141001-310	290	F1144012-310	291	F1147030-310	291	F1151001-310
289	F1119033	290	F1141006	290	F1144018	291	F1147033	291	F1151006
289	F1119033-300	290	F1141006-300	290	F1144018-300	291	F1147033-300	291	F1151006-300
289	F1119033-310	290	F1141006-310	290	F1144018-310	291	F1147033-310	291	F1151006-310
289	F1120001	290	F1141012	290	F1144030	291	F1148001	291	F1151012
289	F1120001-300	290	F1141012-300	290	F1144030-300	291	F1148001-300	291	F1151012-300
289	F1120001-310	290	F1141012-310	290	F1144030-310	291	F1148001-310	291	F1151012-310
289	F1120006	290	F1141018	290	F1144033	291	F1148006	291	F1151018
289	F1120006-300	290	F1141018-300	290	F1144033-300	291	F1148006-300	291	F1151018-300
289	F1120006-310	290	F1141018-310	290	F1144033-310	291	F1148006-310	291	F1151018-310
289	F1120012	290	F1141030	290	F1145001	291	F1148012	291	F1151030
289	F1120012-300	290	F1141030-300	290	F1145001-300	291	F1148012-300	291	F1151030-300
289	F1120012-310	290	F1141030-310	290	F1145001-310	291	F1148012-310	291	F1151030-310
289	F1120018	290	F1141033	290	F1145006	291	F1148018	291	F1151033
289	F1120018-300	290	F1141033-300	290	F1145006-300	291	F1148018-300	291	F1151033-300
289	F1120018-310	290	F1141033-310	290	F1145006-310	291	F1148018-310	291	F1151033-310
289	F1120030	290	F1142001	290	F1145012	291	F1148030	292	F1170001
289	F1120030-300	290	F1142001-300	290	F1145012-300	291	F1148030-300	292	F1170001-300
289	F1120030-310	290	F1142001-310	290	F1145012-310	291	F1148030-310	292	F1170001-310
289	F1120033	290	F1142006	290	F1145018	291	F1148033	292	F1170006
289	F1120033-300	290	F1142006-300	290	F1145018-300	291	F1148033-300	292	F1170006-300
289	F1120033-310	290	F1142006-310	290	F1145018-310	291	F1148033-310	292	F1170006-310
289	F1121001	290	F1142012	290	F1145030	291	F1149001	292	F1170012
289	F1121001-300	290	F1142012-300	290	F1145030-300	291	F1149001-300	292	F1170012-300
289	F1121001-310	290	F1142012-310	290	F1145030-310	291	F1149001-310	292	F1170012-310
289	F1121006	290	F1142018	290	F1145033	291	F1149006	292	F1170018
289	F1121006-300	290	F1142018-300	290	F1145033-300	291	F1149006-300	292	F1170018-300
289	F1121006-310	290	F1142018-310	290	F1145033-310	291	F1149006-310	292	F1170018-310
289	F1121012	290	F1142030	291	F1146001	291	F1149012	292	F1170030
289	F1121012-300	290	F1142030-300	291	F1146001-300	291	F1149012-300	292	F1170030-300
289	F1121012-310	290	F1142030-310	291	F1146001-310	291	F1149012-310	292	F1170030-310
289	F1121018	290	F1142033	291	F1146006	291	F1149018	292	F1170033
289	F1121018-300	290	F1142033-300	291	F1146006-300	291	F1149018-300	292	F1170033-300
289	F1121018-310	290	F1142033-310	291	F1146006-310	291	F1149018-310	292	F1170033-310

Page	Reference	Page	Reference	Page	Reference	Page	Reference	Page	Reference
292	F1171001	292	F1174012	293	F1177030	293	F1181001	177	F1214018
292	F1171001-300	292	F1174012-300	293	F1177030-300	293	F1181001-300	177	F1214030
292	F1171001-310	292	F1174012-310	293	F1177030-310	293	F1181001-310	177	F1214033
292	F1171006	292	F1174018	293	F1177033	293	F1181006	177	F1215001
292	F1171006-300	292	F1174018-300	293	F1177033-300	293	F1181006-300	177	F1215006
292	F1171006-310	292	F1174018-310	293	F1177033-310	293	F1181006-310	177	F1215012
292	F1171012	292	F1174030	293	F1178001	293	F1181012	177	F1215018
292	F1171012-300	292	F1174030-300	293	F1178001-300	293	F1181012-300	177	F1215030
292	F1171012-310	292	F1174030-310	293	F1178001-310	293	F1181012-310	177	F1215033
292	F1171018	292	F1174033	293	F1178006	293	F1181018	177	F1216001
292	F1171018-300	292	F1174033-300	293	F1178006-300	293	F1181018-300	177	F1216006
292	F1171018-310	292	F1174033-310	293	F1178006-310	293	F1181018-310	177	F1216012
292	F1171030	292	F1175001	293	F1178012	293	F1181030	177	F1216018
292	F1171030-300	292	F1175001-300	293	F1178012-300	293	F1181030-300	177	F1216030
292	F1171030-310	292	F1175001-310	293	F1178012-310	293	F1181030-310	177	F1216033
292	F1171033	292	F1175006	293	F1178018	293	F1181033	177	F1217001
292	F1171033-300	292	F1175006-300	293	F1178018-300	293	F1181033-300	177	F1217006
292	F1171033-310	292	F1175006-310	293	F1178018-310	293	F1181033-310	177	F1217012
292	F1172001	292	F1175012	293	F1178030	434	F1203001	177	F1217018
292	F1172001-300	292	F1175012-300	293	F1178030-300	434	F1203006	177	F1217030
292	F1172001-310	292	F1175012-310	293	F1178030-310	434	F1203012	177	F1217033
292	F1172006	292	F1175018	293	F1178033	434	F1203018	177	F1218001
292	F1172006-300	292	F1175018-300	293	F1178033-300	434	F1203030	177	F1218006
292	F1172006-310	292	F1175018-310	293	F1178033-310	434	F1203033	177	F1218012
292	F1172012	292	F1175030	293	F1179001	434	F1204001	177	F1218018
292	F1172012-300	292	F1175030-300	293	F1179001-300	434	F1204006	177	F1218030
292	F1172012-310	292	F1175030-310	293	F1179001-310	434	F1204012	177	F1218033
292	F1172018	292	F1175033	293	F1179006	434	F1204018	178	F1230001
292	F1172018-300	292	F1175033-300	293	F1179006-300	434	F1204030	178	F1230001-300
292	F1172018-310	292	F1175033-310	293	F1179006-310	434	F1204033	178	F1230001-310
292	F1172030	293	F1176001	293	F1179012	181	F1207000	178	F1230006
292	F1172030-300	293	F1176001-300	293	F1179012-300	181	F1208000	178	F1230006-300
292	F1172030-310	293	F1176001-310	293	F1179012-310	176	F1209000	178	F1230006-310
292	F1172033	293	F1176006	293	F1179018	177	F1210001	178	F1230012
292	F1172033-300	293	F1176006-300	293	F1179018-300	177	F1210006	178	F1230012-300
292	F1172033-310	293	F1176006-310	293	F1179018-310	177	F1210012	178	F1230012-310
292	F1173001	293	F1176012	293	F1179030	177	F1210018	178	F1230018
292	F1173001-300	293	F1176012-300	293	F1179030-300	177	F1210030	178	F1230018-300
292	F1173001-310	293	F1176012-310	293	F1179030-310	177	F1210033	178	F1230018-310
292	F1173006	293	F1176018	293	F1179033	177	F1211001	178	F1230030
292	F1173006-300	293	F1176018-300	293	F1179033-300	177	F1211006	178	F1230030-300
292	F1173006-310	293	F1176018-310	293	F1179033-310	177	F1211012	178	F1230030-310
292	F1173012	293	F1176030	293	F1180001	177	F1211018	178	F1230033
292	F1173012-300	293	F1176030-						

Page	Reference	Page	Reference	Page	Reference	Page	Reference	Page	Reference
178	F1231033	178	F1235006	178	F1238018	179	F1258018	180	F1273006
178	F1231033-300	178	F1235006-300	178	F1238018-300	179	F1258030	180	F1273006-300
178	F1231033-310	178	F1235006-310	178	F1238018-310	179	F1258033	180	F1273006-310
178	F1232001	178	F1235012	178	F1238030	180	F1270001	180	F1273012
178	F1232001-300	178	F1235012-300	178	F1238030-300	180	F1270001-300	180	F1273012-300
178	F1232001-310	178	F1235012-310	178	F1238030-310	180	F1270001-310	180	F1273012-310
178	F1232006	178	F1235018	178	F1238033	180	F1270006	180	F1273018
178	F1232006-300	178	F1235018-300	178	F1238033-300	180	F1270006-300	180	F1273018-300
178	F1232006-310	178	F1235018-310	178	F1238033-310	180	F1270006-310	180	F1273018-310
178	F1232012	178	F1235030	179	F1250001	180	F1270012	180	F1273030
178	F1232012-300	178	F1235030-300	179	F1250006	180	F1270012-300	180	F1273030-300
178	F1232012-310	178	F1235030-310	179	F1250012	180	F1270012-310	180	F1273030-310
178	F1232018	178	F1235033	179	F1250018	180	F1270018	180	F1273033
178	F1232018-300	178	F1235033-300	179	F1250030	180	F1270018-300	180	F1273033-300
178	F1232018-310	178	F1235033-310	179	F1250033	180	F1270018-310	180	F1273033-310
178	F1232030	178	F1236001	179	F1251001	180	F1270030	180	F1274001
178	F1232030-300	178	F1236001-300	179	F1251006	180	F1270030-300	180	F1274001-300
178	F1232030-310	178	F1236001-310	179	F1251012	180	F1270030-310	180	F1274001-310
178	F1232033	178	F1236006	179	F1251018	180	F1270033	180	F1274006
178	F1232033-300	178	F1236006-300	179	F1251030	180	F1270033-300	180	F1274006-300
178	F1232033-310	178	F1236006-310	179	F1251033	180	F1270033-310	180	F1274006-310
178	F1233001	178	F1236012	179	F1252001	180	F1271001	180	F1274012
178	F1233001-300	178	F1236012-300	179	F1252006	180	F1271001-300	180	F1274012-300
178	F1233001-310	178	F1236012-310	179	F1252012	180	F1271001-310	180	F1274012-310
178	F1233006	178	F1236018	179	F1252018	180	F1271006	180	F1274018
178	F1233006-300	178	F1236018-300	179	F1252030	180	F1271006-300	180	F1274018-300
178	F1233006-310	178	F1236018-310	179	F1252033	180	F1271006-310	180	F1274018-310
178	F1233012	178	F1236030	179	F1253001	180	F1271012	180	F1274030
178	F1233012-300	178	F1236030-300	179	F1253006	180	F1271012-300	180	F1274030-300
178	F1233012-310	178	F1236030-310	179	F1253012	180	F1271012-310	180	F1274030-310
178	F1233018	178	F1236033	179	F1253018	180	F1271018	180	F1274033
178	F1233018-300	178	F1236033-300	179	F1253030	180	F1271018-300	180	F1274033-300
178	F1233018-310	178	F1236033-310	179	F1253033	180	F1271018-310	180	F1274033-310
178	F1233030	178	F1237001	179	F1254001	180	F1271030	180	F1275001
178	F1233030-300	178	F1237001-300	179	F1254006	180	F1271030-300	180	F1275001-300
178	F1233030-310	178	F1237001-310	179	F1254012	180	F1271030-310	180	F1275001-310
178	F1233033	178	F1237006	179	F1254018	180	F1271033	180	F1275006
178	F1233033-300	178	F1237006-300	179	F1254030	180	F1271033-300	180	F1275006-300
178	F1233033-310	178	F1237006-310	179	F1254033	180	F1271033-310	180	F1275006-310
178	F1234001	178	F1237012	179	F1255001	180	F1272001	180	F1275012
178	F1234001-300	178	F1237012-300	179	F1255006	180	F1272001-300	180	F1275012-300
178	F1234001-310	178	F1237012-310	179	F1255012	180	F1272001-310	180	F1275012-310
178	F1234006	178	F1237018	179	F1255018	180	F1272006	180	F1275018
178	F1234006-300	178	F1237018-300	179	F1255030	180	F1272006-300	180	F1275018-300
178	F1234006-310	178	F1237018-310	179	F1255033	180	F1272006-310	180	F1275018-310
178	F1234012	178	F1237030	179	F1256001	180	F1272012	180	F1275030
178	F1234012-300	178	F1237030-300	179	F1256006	180	F1272012-300	180	F1275030-300
178	F1234012-310	178	F1237030-310	179	F1256012	180	F1272012-310	180	F1275030-310
178	F1234018	178	F1237033	179	F1256018	180	F1272018	180	F1275033
178	F1234018-300	178	F1237033-300	179	F1256030	180	F1272018-300	180	F1275033-300
178	F1234018-310	178	F1237033-310	179	F1256033	180	F1272018-310	180	F1275033-310
178	F1234030	178	F1238001	179	F1257001	180	F1272030	180	F1276001
178	F1234030-300	178	F1238001-300	179	F1257006	180	F1272030-300	180	F1276001-300
178	F1234030-310	178	F1238001-310	179	F1257012	180	F1272030-310	180	F1276001-310
178	F1234033	178	F1238006	179	F1257018	180	F1272033	180	F1276006
178	F1234033-300	178	F1238006-300	179	F1257030	180	F1272033-300	180	F1276006-300
178	F1234033-310	178	F1238006-310	179	F1257033	180	F1272033-310	180	F1276006-310
178	F1235001	178	F1238012	179	F1258001	180	F1273001	180	F1276012
178	F1235001-300	178	F1238012-300	179	F1258006	180	F1273001-300	180	F1276012-300
178	F1235001-310	178	F1238012-310	179	F1258012	180	F1273001-310	180	F1276012-310

Page	Reference	Page	Reference	Page	Reference	Page	Reference	Page	Reference
180	F1276018	278	F1311030	278	F1316030	332	F2251033	270	F4353030-310
180	F1276018-300	278	F1311033	278	F1316030-300	332	F2252001	270	F4353033
180	F1276018-310	278	F1311087	278	F1316030-310	332	F2252006	270	F4353033-300
180	F1276030	278	F1311089	278	F1316033	332	F2252012	270	F4353033-310
180	F1276030-300	278	F1311090	278	F1316033-300	332	F2252018	270	F4354001
180	F1276030-310	278	F1312000	278	F1316033-310	332	F2252030	270	F4354001-300
180	F1276033	278	F1312001	278	F1316087	332	F2252033	270	F4354001-310
180	F1276033-300	278	F1312006	278	F1316087-300	332	F2260001	270	F4354006
180	F1276033-310	278	F1312012	278	F1316087-310	332	F2260006	270	F4354006-300
180	F1277001	278	F1312018	278	F1316089	332	F2260012	270	F4354006-310
180	F1277001-300	278	F1312030	278	F1316089-300	332	F2260018	270	F4354012
180	F1277001-310	278	F1312033	278	F1316089-310	332	F2260030	270	F4354012-300
180	F1277006	278	F1312087	278	F1316090	332	F2260033	270	F4354012-310
180	F1277006-300	278	F1312089	278	F1316090-300	332	F2261001	270	F4354018
180	F1277006-310	278	F1312090	278	F1316090-310	332	F2261006	270	F4354018-300
180	F1277012	278	F1315000	278	F1317000	332	F2261012	270	F4354018-310
180	F1277012-300	278	F1315000-300	278	F1317000-300	332	F2261018	270	F4354030
180	F1277012-310	278	F1315000-310	278	F1317000-310	332	F2261030	270	F4354030-300
180	F1277018	278	F1315001	278	F1317001	332	F2261033	270	F4354030-310
180	F1277018-300	278	F1315001-300	278	F1317001-300	332	F2262001	270	F4354033
180	F1277018-310	278	F1315001-310	278	F1317001-310	332	F2262006	270	F4354033-300
180	F1277030	278	F1315006	278	F1317006	332	F2262012	270	F4354033-310
180	F1277030-300	278	F1315006-300	278	F1317006-300	332	F2262018	270	F4355001
180	F1277030-310	278	F1315006-310	278	F1317006-310	332	F2262030	270	F4355001-300
180	F1277033	278	F1315012	278	F1317012	332	F2262033	270	F4355001-310
180	F1277033-300	278	F1315012-300	278	F1317012-300	271	F4301000	270	F4355006
180	F1277033-310	278	F1315012-310	278	F1317012-310	271	F4302000	270	F4355006-300
180	F1278001	278	F1315018	278	F1317018	271	F4303000	270	F4355006-310
180	F1278001-300	278	F1315018-300	278	F1317018-300	270	F4350001	270	F4355012
180	F1278001-310	278	F1315018-310	278	F1317018-310	270	F4350006	270	F4355012-300
180	F1278006	278	F1315030	278	F1317030	270	F4350012	270	F4355012-310
180	F1278006-300	278	F1315030-300	278	F1317030-300	270	F4350018	270	F4355018
180	F1278006-310	278	F1315030-310	278	F1317030-310	270	F4350030	270	F4355018-300
180	F1278012	278	F1315033	278	F1317033	270	F4350033	270	F4355018-310
180	F1278012-300	278	F1315033-300	278	F1317033-300	270	F4351001	270	F4355030
180	F1278012-310	278	F1315033-310	278	F1317033-310	270	F4351006	270	F4355030-300
180	F1278018	278	F1315087	278	F1317087	270	F4351012	270	F4355030-310
180	F1278018-300	278	F1315087-300	278	F1317087-300	270	F4351018	270	F4355033
180	F1278018-310	278	F1315087-310	278	F1317087-310	270	F4351030	270	F4355033-300
180	F1278030	278	F1315089	278	F1317089	270	F4351033	270	F4355033-310
180	F1278030-300	278	F1315089-300	278	F1317089-300	270	F4352001	271	F4356001
180	F1278030-310	278	F1315089-310	278	F1317089-310	270	F4352006	271	F4356001-300
180	F1278033	278	F1315090	278	F1317090	270	F4352012	271	F4356001-310
180	F1278033-300	278	F1315090-300	278	F1317090-300	270	F4352018	271	F4356006
180	F1278033-310	278	F1315090-310	278	F1317090-3				

Page	Reference	Page	Reference	Page	Reference	Page	Reference	Page	Reference
271	F4357001-310	342	F4575045	341	F4582056-310	341	F4587056-310	340	F4592056-310
271	F4357006	342	F4575048	341	F4582065	341	F4587065	340	F4592065
271	F4357006-300	342	F4575056	341	F4582065-300	341	F4587065-300	340	F4592065-300
271	F4357006-310	342	F4575065	341	F4582065-310	341	F4587065-310	340	F4592065-310
271	F4357012	342	F4576045	341	F4583045	340	F4588045	340	F4593045
271	F4357012-300	342	F4576048	341	F4583045-300	340	F4588045-300	340	F4593045-300
271	F4357012-310	342	F4576056	341	F4583045-310	340	F4588045-310	340	F4593045-310
271	F4357018	342	F4576065	341	F4583048	340	F4588048	340	F4593048
271	F4357018-300	342	F4577045	341	F4583048-300	340	F4588048-300	340	F4593048-300
271	F4357018-310	342	F4577048	341	F4583048-310	340	F4588048-310	340	F4593048-310
271	F4357030	342	F4577056	341	F4583056	340	F4588056	340	F4593056
271	F4357030-300	342	F4577065	341	F4583056-300	340	F4588056-300	340	F4593056-300
271	F4357030-310	342	F4578045	341	F4583056-310	340	F4588056-310	340	F4593056-310
271	F4357033	342	F4578048	341	F4583065	340	F4588065	340	F4593065
271	F4357033-300	342	F4578056	341	F4583065-300	340	F4588065-300	340	F4593065-300
271	F4357033-310	342	F4578065	341	F4583065-310	340	F4588065-310	340	F4593065-310
271	F4358001	341	F4579045	341	F4584045	340	F4589045	340	F4594045
271	F4358001-300	341	F4579045-300	341	F4584045-300	340	F4589045-300	340	F4594045-300
271	F4358001-310	341	F4579045-310	341	F4584045-310	340	F4589045-310	340	F4594045-310
271	F4358006	341	F4579048	341	F4584048	340	F4589048	340	F4594048
271	F4358006-300	341	F4579048-300	341	F4584048-300	340	F4589048-300	340	F4594048-300
271	F4358006-310	341	F4579048-310	341	F4584048-310	340	F4589048-310	340	F4594048-310
271	F4358012	341	F4579056	341	F4584056	340	F4589056	340	F4594056
271	F4358012-300	341	F4579056-300	341	F4584056-300	340	F4589056-300	340	F4594056-300
271	F4358012-310	341	F4579056-310	341	F4584056-310	340	F4589056-310	340	F4594056-310
271	F4358018	341	F4579065	341	F4584065	340	F4589065	340	F4594065
271	F4358018-300	341	F4579065-300	341	F4584065-300	340	F4589065-300	340	F4594065-300
271	F4358018-310	341	F4579065-310	341	F4584065-310	340	F4589065-310	340	F4594065-310
271	F4358030	341	F4580045	341	F4585045	340	F4590045	340	F4595045
271	F4358030-300	341	F4580045-300	341	F4585045-300	340	F4590045-300	340	F4595045-300
271	F4358030-310	341	F4580045-310	341	F4585045-310	340	F4590045-310	340	F4595045-310
271	F4358033	341	F4580048	341	F4585048	340	F4590048	340	F4595048
271	F4358033-300	341	F4580048-300	341	F4585048-300	340	F4590048-300	340	F4595048-300
271	F4358033-310	341	F4580048-310	341	F4585048-310	340	F4590048-310	340	F4595048-310
343	F4555000	341	F4580056	341	F4585056	340	F4590056	340	F4595056
343	F4556000	341	F4580056-300	341	F4585056-300	340	F4590056-300	340	F4595056-300
343	F4557000	341	F4580056-310	341	F4585056-310	340	F4590056-310	340	F4595056-310
343	F4558000	341	F4580065	341	F4585065	340	F4590065	340	F4595065
343	F4559000	341	F4580065-300	341	F4585065-300	340	F4590065-300	340	F4595065-300
343	F4560000	341	F4580065-310	341	F4585065-310	340	F4590065-310	340	F4595065-310
342	F4570045	341	F4581045	341	F4586045	340	F4591045	340	F4596045
342	F4570048	341	F4581045-300	341	F4586045-300	340	F4591045-300	340	F4596045-300
342	F4570056	341	F4581045-310	341	F4586045-310	340	F4591045-310	340	F4596045-310
342	F4570065	341	F4581048	341	F4586048	340	F4591048	340	F4596048
342	F4571045	341	F4581048-300	341	F4586048-300	340	F4591048-300	340	F4596048-300
342	F4571048	341	F4581048-310	341	F4586048-310	340	F4591048-310	340	F4596048-310
342	F4571056	341	F4581056	341	F4586056	340	F4591056	340	F4596056
342	F4571065	341	F4581056-300	341	F4586056-300	340	F4591056-300	340	F4596056-300
342	F4572045	341	F4581056-310	341	F4586056-310	340	F4591056-310	340	F4596056-310
342	F4572048	341	F4581065	341	F4586065	340	F4591065	340	F4596065
342	F4572056	341	F4581065-300	341	F4586065-300	340	F4591065-300	340	F4596065-300
342	F4572065	341	F4581065-310	341	F4586065-310	340	F4591065-310	340	F4596065-310
342	F4573045	341	F4582045	341	F4587045	340	F4592045	343	F4597000
342	F4573048	341	F4582045-300	341	F4587045-300	340	F4592045-300	343	F4598000
342	F4573056	341	F4582045-310	341	F4587045-310	340	F4592045-310	343	F4599000
342	F4573065	341	F4582048	341	F4587048	340	F4592048	260	F5960044
342	F4574045	341	F4582048-300	341	F4587048-300	340	F4592048-300	260	F5960047
342	F4574048	341	F4582048-310	341	F4587048-310	340	F4592048-310	260	F5960055
342	F4574056	341	F4582056	341	F4587056	340	F4592056	260	F5960066
342	F4574065	341	F4582056-300	341	F4587056-300	340	F4592056-300	260	F5961044

Page	Reference	Page	Reference	Page	Reference	Page	Reference	Page	Reference
260	F5961047	402	FA100174132	505	FA1022290006	579	FA1051072233	578	FA1051721201
260	F5961055	398	FA10017440	505	FA1022290012	579	FA1051072270	578	FA1051721206
260	F5961066	402	FA10017441	505	FA1022290018	576	FA1051440001	578	FA1051721212
261	F5962000	396	FA100176118	505	FA1022290030	576	FA1051440006	578	FA1051721218
260	F5970044	396	FA10017612	505	FA1022290033	576	FA1051440012	578	FA1051721230
260	F5970047	400	FA100176124	505	FA102950001	576	FA1051440018	578	FA1051721233
260	F5970055	400	FA100176133	505	FA102950006	576	FA1051440030	578	FA1051721270
260	F5970066	396	FA10017640	505	FA102950012	576	FA1051440033	597	FA10517214457
260	F5971044	400	FA10017641	505	FA102950018	576	FA1051440070	597	FA10517214657
260	F5971047	396	FA100177118	505	FA102950030	576	FA1051441201	577	FA1051730001
260	F5971055	396	FA10017712	505	FA102950033	576	FA1051441206	577	FA1051730006
260	F5971066	400	FA100177124	505	FA102960001	576	FA1051441212	577	FA1051730012
260	F5980044	400	FA100177133	505	FA102960006	576	FA1051441218	577	FA1051730018
260	F5980047	396	FA10017740	505	FA102960012	576	FA1051441230	577	FA1051730030
260	F5980055	400	FA10017741	505	FA102960018	576	FA1051441233	577	FA1051730033
260	F5980066	397	FA10017912	505	FA102960030	576	FA1051441270	577	FA1051730070
260	F5981044	398	FA100179122	505	FA102960033	576	FA1051442001	596	FA10517314357
260	F5981047	402	FA100179125	234	FA1041040090	576	FA1051442006	580	FA1051740001
260	F5981055	401	FA100179130	234	FA1041060090	576	FA1051442012	580	FA1051740006
260	F5981066	401	FA100179132	234	FA1041970090	576	FA1051442018	580	FA1051740012
139	F6268022	397	FA10017930	579	FA1051070001	576	FA1051442030	580	FA1051740018
139	F6268041	397	FA10017940	579	FA1051070006	576	FA1051442033	580	FA1051740030
139	F6367022	401	FA10017941	579	FA1051070012	576	FA1051442070	580	FA1051740033
139	F6367041	397	FA10018012	579	FA1051070018	576	FA1051442201	580	FA1051740070
138	F6468022	398	FA100180122	579	FA1051070030	576	FA1051442206	580	FA1051741201
138	F6468041	402	FA100180125	579	FA1051070033	576	FA1051442212	580	FA1051741206
138	F6469022	401	FA100180130	579	FA1051070070	576	FA1051442218	580	FA1051741212
138	F6469041	401	FA100180132	579	FA1051071101	576	FA1051442230	580	FA1051741218
156	F990B00A000	397	FA10018030	579	FA1051071106	576	FA1051442233	580	FA1051741230
156	F990B01A000	397	FA10018040	579	FA1051071112	576	FA1051442270	580	FA1051741233
156	F990B02A000	401	FA10018041	579	FA1051071118	576	FA1051710001	580	FA1051741270
156	F990B03A000	396	FA100181118	579	FA1051071130	576	FA1051710006	597	FA10517414457
156	F990B04A000	396	FA10018112	579	FA1051071133	576	FA1051710012	579	FA1051900001
156	F990B05A000	400	FA100181124	579	FA1051071170	576	FA1051710018	579	FA1051900006
435	F990B07A000	400	FA100181133	579	FA1051071201	576	FA1051710030	579	FA1051900012
434	F990B08A000	396	FA10018140	579	FA1051071206	576	FA1051710033	579	FA1051900018
435	F990B09A000	400	FA10018141	579	FA1051071212	576	FA1051710070	579	FA1051900030
405	F990B10A000	397	FA10018212	579	FA1051071218	576	FA1051711201	579	FA1051900033
405	F990B11A000	398	FA100182122	579	FA1051071230	576	FA1051711206	579	FA1051900070
460	F990B11A000	402	FA100182125	579	FA1051071233	576	FA1051711212	579	FA1051901101
405	F990B12A000	401	FA100182130	579	FA1051071270	576	FA1051711218	579	FA1051901106
460	F990B12A000	401	FA100182132	579	FA1051072001	576	FA1051711230	579	FA1051901112
405	F990B13A000	397	FA10018230	579	FA1051072006	576	FA1051711233	579	FA1051901118
435									

Page	Reference	Page	Reference	Page	Reference	Page	Reference	Page	Reference
582	FA1052510033	581	FA1052551212	578	FA105562018	323	FA1072314401	323	FA1072794401
582	FA1052510070	581	FA1052551218	578	FA105562030	323	FA1072314406	323	FA1072794406
582	FA1052511201	581	FA1052551230	578	FA105562033	323	FA1072314412	323	FA1072794412
582	FA1052511206	581	FA1052551233	578	FA105562070	323	FA1072314418	323	FA1072794418
582	FA1052511212	581	FA1052551270	578	FA105562101	323	FA1072314430	323	FA1072794430
582	FA1052511218	581	FA1052552001	578	FA105562106	323	FA1072314433	323	FA1072794433
582	FA1052511230	581	FA1052552006	578	FA105562112	323	FA1072315101	323	FA1072795101
582	FA1052511233	581	FA1052552012	578	FA105562118	323	FA1072315106	323	FA1072795106
582	FA1052511270	581	FA1052552018	578	FA105562130	323	FA1072315112	323	FA1072795112
582	FA1052520001	581	FA1052552030	578	FA105562133	323	FA1072315118	323	FA1072795118
582	FA1052520006	581	FA1052552033	578	FA105562170	323	FA1072315130	323	FA1072795130
582	FA1052520012	581	FA1052552070	578	FA105562201	323	FA1072315133	323	FA1072795133
582	FA1052520018	581	FA1052552201	578	FA105562206	323	FA1072315301	324	FA107924501
582	FA1052520030	581	FA1052552206	578	FA105562212	323	FA1072315306	324	FA107924506
582	FA1052520033	581	FA1052552212	578	FA105562218	323	FA1072315312	324	FA107924512
582	FA1052520070	581	FA1052552218	578	FA105562230	323	FA1072315318	324	FA107924518
582	FA1052521201	581	FA1052552230	578	FA105562233	323	FA1072315330	324	FA107924530
582	FA1052521206	581	FA1052552233	578	FA105562270	323	FA1072315333	324	FA107924533
582	FA1052521212	581	FA1052552270	322	FA1071164301	324	FA1072324501	324	FA107925201
582	FA1052521218	583	FA1052560001	322	FA1071164306	324	FA1072324506	324	FA107925206
582	FA1052521230	583	FA1052560006	322	FA1071164312	324	FA1072324512	324	FA107925212
582	FA1052521233	583	FA1052560012	322	FA1071164318	324	FA1072324518	324	FA107925218
582	FA1052521270	583	FA1052560018	322	FA1071164330	324	FA1072324530	324	FA107925230
582	FA1052522001	583	FA1052560030	322	FA1071164333	324	FA1072324533	324	FA107925233
582	FA1052522006	583	FA1052560033	322	FA1071165001	324	FA1072325201	235	FA109
582	FA1052522012	583	FA1052560070	322	FA1071165006	324	FA1072325206	610	FA110501
582	FA1052522018	583	FA1052561201	322	FA1071165012	324	FA1072325212	610	FA110506
582	FA1052522030	583	FA1052561206	322	FA1071165018	324	FA1072325218	610	FA110512
582	FA1052522033	583	FA1052561212	322	FA1071165030	324	FA1072325230	610	FA110518
582	FA1052522070	583	FA1052561218	322	FA1071165033	324	FA1072325233	610	FA110530
582	FA1052522201	583	FA1052561230	323	FA1071194401	324	FA1072724701	610	FA110533
582	FA1052522206	583	FA1052561233	323	FA1071194406	324	FA1072724706	610	FA110901
582	FA1052522212	583	FA1052561270	323	FA1071194412	324	FA1072724712	610	FA110906
582	FA1052522218	599	FA10525614557	323	FA1071194418	324	FA1072724718	610	FA110912
582	FA1052522230	598	FA10526614557	323	FA1071194430	324	FA1072724730	610	FA110918
582	FA1052522233	598	FA10526614757	323	FA1071194433	324	FA1072724733	610	FA110930
582	FA1052522270	578	FA105560001	323	FA1071195101	324	FA1072724901	610	FA110933
581	FA1052540001	578	FA105560006	323	FA1071195106	324	FA1072724906	617	FA11206
581	FA1052540006	578	FA105560012	323	FA1071195112	324	FA1072724912	617	FA11233
581	FA1052540012	578	FA105560018	323	FA1071195118	324	FA1072724918	617	FA11306
581	FA1052540018	578	FA105560030	323	FA1071195130	324	FA1072724930	617	FA11333
581	FA1052540030	578	FA105560033	323	FA1071195133	324	FA1072724933	617	FA11406
581	FA1052540033	578	FA105560070	323	FA1071225301	323	FA1072725301	617	FA11433
581	FA1052540070	578	FA105561101	323	FA1071225306	323	FA1072725306	617	FA11506
581	FA1052541201	578	FA105561106	323	FA1071225312	323	FA1072725312	617	FA11533
581	FA1052541206	578	FA105561112	323	FA1071225318	323	FA1072725318	612	FA116
581	FA1052541212	578	FA105561118	323	FA1071225330	323	FA1072725330	528	FA11617211301
581	FA1052541218	578	FA105561130	323	FA1071225333	323	FA1072725333	528	FA11617211306
581	FA1052541230	578	FA105561133	322	FA1072304301	322	FA1072764301	528	FA11617211312
581	FA1052541233	578	FA105561170	322	FA1072304306	322	FA1072764306	528	FA11617211318
581	FA1052541270	578	FA105561201	322	FA1072304312	322	FA1072764312	528	FA11617211330
581	FA1052550001	578	FA105561206	322	FA1072304318	322	FA1072764318	528	FA11617211333
581	FA1052550006	578	FA105561212	322	FA1072304330	322	FA1072764330	527	FA1161721201
581	FA1052550012	578	FA105561218	322	FA1072304333	322	FA1072764333	527	FA1161721206
581	FA1052550018	578	FA105561230	322	FA1072305001	322	FA1072765001	527	FA1161721212
581	FA1052550030	578	FA105561233	322	FA1072305006	322	FA1072765006	527	FA1161721218
581	FA1052550033	578	FA105561270	322	FA1072305012	322	FA1072765012	527	FA1161721230
581	FA1052550070	578	FA105562001	322	FA1072305018	322	FA1072765018	527	FA1161721233
581	FA1052551201	578	FA105562006	322	FA1072305030	322	FA1072765030	527	FA1161722101
581	FA1052551206	578	FA105562012	322	FA1072305033	322	FA1072765033	527	FA1161722106

Page	Reference	Page	Reference	Page	Reference	Page	Reference	Page	Reference
527	FA1161722112	527	FA116562112	529	FA11726914930	530	FA11827215112	506	FA160
527	FA1161722118	527	FA116562118	529	FA11726914933	530	FA11827215118	633	FA16101
527	FA1161722130	527	FA116562130	529	FA11727914601	530	FA11827215130	609	FA161011201
527	FA1161722133	527	FA116562133	529	FA11727914606	530	FA11827215133	609	FA161011206
528	FA1161724201	528	FA116564201	529	FA11727914612	530	FA11827215201	609	FA161011212
528	FA1161724206	528	FA116564206	529	FA11727914618	530	FA11827215206	609	FA161011218
528	FA1161724212	528	FA116564212	529	FA11727914630	530	FA11827215212	609	FA161011230
528	FA1161724218	528	FA116564218	529	FA11727914633	530	FA11827215218	609	FA161011233
528	FA1161724230	528	FA116564230	529	FA11727914701	530	FA11827215230	609	FA161011301
528	FA1161724233	528	FA116564233	529	FA11727914706	530	FA11827215233	609	FA161011306
528	FA1162711301	610	FA11701	529	FA11727914712	530	FA11827215301	609	FA161011312
528	FA1162711306	610	FA11706	529	FA11727914718	530	FA11827215306	609	FA161011318
528	FA1162711312	610	FA11712	529	FA11727914730	530	FA11827215312	609	FA161011330
528	FA1162711318	610	FA11718	529	FA11727914733	530	FA11827215318	609	FA161011333
528	FA1162711330	529	FA11726814601	529	FA11727914801	530	FA11827215330	609	FA161012201
528	FA1162711333	529	FA11726814606	529	FA11727914806	530	FA11827215333	609	FA161012206
527	FA116271201	529	FA11726814612	529	FA11727914812	530	FA11828215001	609	FA161012212
527	FA116271206	529	FA11726814618	529	FA11727914818	530	FA11828215006	609	FA161012218
527	FA116271212	529	FA11726814630	529	FA11727914830	530	FA11828215012	609	FA161012230
527	FA116271218	529	FA11726814633	529	FA11727914833	530	FA11828215018	609	FA161012233
527	FA116271230	529	FA11726814701	529	FA11727914901	530	FA11828215030	609	FA161012301
527	FA116271233	529	FA11726814706	529	FA11727914906	530	FA11828215033	609	FA161012306
527	FA116272101	529	FA11726814712	529	FA11727914912	530	FA11828215101	609	FA161012312
527	FA116272106	529	FA11726814718	529	FA11727914918	530	FA11828215106	609	FA161012318
527	FA116272112	529	FA11726814730	529	FA11727914930	530	FA11828215112	609	FA161012330
527	FA116272118	529	FA11726814733	529	FA11727914933	530	FA11828215118	609	FA161012333
527	FA116272130	529	FA11726814801	610	FA11730	530	FA11828215130	633	FA16106
527	FA116272133	529	FA11726814806	610	FA11733	530	FA11828215133	633	FA16112
528	FA116274201	529	FA11726814812	530	FA11827115001	530	FA11828215201	633	FA16118
528	FA116274206	529	FA11726814818	530	FA11827115006	530	FA11828215206	633	FA16130
528	FA116274212	529	FA11726814830	530	FA11827115012	530	FA11828215212	633	FA16133
528	FA116274218	529	FA11726814833	530	FA11827115018	530	FA11828215218	633	FA16201
528	FA116274230	529	FA11726814901	530	FA11827115030	530	FA11828215230	633	FA16206
528	FA116274233	529	FA11726814906	530	FA11827115033	530	FA11828215233	633	FA16212
527	FA116282101	529	FA11726814912	530	FA11827115101	530	FA11828215301	633	FA16218
527	FA116282106	529	FA11726814918	530	FA11827115106	530	FA11828215306	609	FA162241201
527	FA116282112	529	FA11726814930	530	FA11827115112	530	FA11828215312	609	FA162241206
527	FA116282118	529	FA11726814933	530	FA11827115118	530	FA11828215318	609	FA162241212
527	FA116282130	529	FA11726914601	530	FA11827115130	530	FA11828215330</		

Page	Reference	Page	Reference	Page	Reference	Page	Reference	Page	Reference
608	FA162801433	645	FA18130	506	FA24530	243	FA50301030	307	FA50701230
608	FA162811301	645	FA18133	506	FA24533	243	FA50301033	307	FA50701233
608	FA162811306	633	FA182	506	FA247	242	FA50301101	307	FA50701301
608	FA162811312	412	FA183	610	FA24806	242	FA50301106	307	FA50701306
608	FA162811318	584	FA184	610	FA24833	242	FA50301112	307	FA50701312
608	FA162811330	226	FA185	610	FA24906	242	FA50301118	307	FA50701318
608	FA162811333	380	FA192	610	FA24933	242	FA50301130	307	FA50701330
608	FA162811401	380	FA193	610	FA25006	242	FA50301133	307	FA50701333
608	FA162811406	380	FA194	610	FA25033	242	FA50301201	307	FA50701501
608	FA162811412	380	FA195	610	FA25106	242	FA50301206	307	FA50701506
608	FA162811418	546	FA196	610	FA25133	242	FA50301212	307	FA50701512
608	FA162811430	546	FA197	566	FA26130	242	FA50301218	307	FA50701518
608	FA162811433	546	FA198	566	FA26230	242	FA50301230	307	FA50701530
608	FA162812301	546	FA199	566	FA26330	242	FA50301233	307	FA50701533
608	FA162812306	567	FA203	555	FA264	243	FA50320201	308	FA50702201
608	FA162812312	566	FA20530	555	FA266	243	FA50320206	308	FA50702206
608	FA162812318	566	FA20630	555	FA268	243	FA50320212	308	FA50702212
608	FA162812330	566	FA20730	610	FA414006	243	FA50320218	308	FA50702218
608	FA162812333	566	FA20830	610	FA414033	243	FA50320230	308	FA50702230
608	FA162812401	566	FA20930	610	FA414506	243	FA50320233	308	FA50702233
608	FA162812406	226	FA21	610	FA414533	243	FA50320401	308	FA50702301
608	FA162812412	566	FA21030	610	FA415006	243	FA50320406	308	FA50702306
608	FA162812418	566	FA21130	610	FA415033	243	FA50320412	308	FA50702312
608	FA162812430	566	FA21230	610	FA415506	243	FA50320418	308	FA50702318
608	FA162812433	566	FA21330	610	FA415533	243	FA50320430	308	FA50702330
637	FA16530	585	FA218	357	FA50	243	FA50320433	308	FA50702333
637	FA16630	381	FA219	243	FA50300201	242	FA50320601	308	FA50702501
645	FA16730	381	FA220	243	FA50300206	242	FA50320606	308	FA50702506
645	FA16830	613	FA22106	243	FA50300212	242	FA50320612	308	FA50702512
474	FA172	613	FA22133	243	FA50300218	242	FA50320618	308	FA50702518
474	FA173	613	FA22206	243	FA50300230	242	FA50320630	308	FA50702530
474	FA174	613	FA22233	243	FA50300233	242	FA50320633	308	FA50702533
633	FA17701	613	FA22306	243	FA50300401	242	FA50320801	308	FA50703201
633	FA17706	613	FA22333	243	FA50300406	242	FA50320806	308	FA50703206
633	FA17712	613	FA22406	243	FA50300412	242	FA50320812	308	FA50703212
633	FA17718	613	FA22433	243	FA50300418	242	FA50320818	308	FA50703218
633	FA17730	612	FA22506	243	FA50300430	242	FA50320830	308	FA50703230
633	FA17733	612	FA22533	243	FA50300433	242	FA50320833	308	FA50703233
633	FA17801	612	FA22606	242	FA50300601	307	FA50700201	308	FA50703301
633	FA17806	612	FA22633	242	FA50300606	307	FA50700206	308	FA50703306
633	FA17812	612	FA22706	242	FA50300612	307	FA50700212	308	FA50703312
633	FA17818	612	FA22733	242	FA50300618	307	FA50700218	308	FA50703318
633	FA17830	612	FA22806	242	FA50300630	307	FA50700230	308	FA50703330
633	FA17833	612	FA22833	242	FA50300633	307	FA50700233	308	FA50703333
636	FA17901	613	FA22906	242	FA50300801	307	FA50700301	308	FA50703501
636	FA17906	613	FA22933	242	FA50300806	307	FA50700306	308	FA50703506
636	FA17912	613	FA23006	242	FA50300812	307	FA50700312	308	FA50703512
636	FA17918	613	FA23033	242	FA50300818	307	FA50700318	308	FA50703518
636	FA17930	613	FA23106	242	FA50300830	307	FA50700330	308	FA50703530
636	FA17933	613	FA23133	242	FA50300833	307	FA50700333	308	FA50703533
636	FA18001	613	FA23206	243	FA50300901	307	FA50700501	309	FA50710201
636	FA18006	613	FA23233	243	FA50300906	307	FA50700506	309	FA50710206
636	FA18012	595	FA235	243	FA50300912	307	FA50700512	309	FA50710212
636	FA18018	585	FA238	243	FA50300918	307	FA50700518	309	FA50710218
636	FA18030	585	FA239	243	FA50300930	307	FA50700530	309	FA50710230
636	FA18033	612	FA243	243	FA50300933	307	FA50700533	309	FA50710233
645	FA18101	506	FA24501	243	FA50301001	307	FA50701201	309	FA50710301
645	FA18106	506	FA24506	243	FA50301006	307	FA50701206	309	FA50710306
645	FA18112	506	FA24512	243	FA50301012	307	FA50701212	309	FA50710312
645	FA18118	506	FA24518	243	FA50301018	307	FA50701218	309	FA50710318

Page	Reference	Page	Reference	Page	Reference	Page	Reference	Page	Reference
309	FA50710330	310	FA50713530	305	FA50803230	301	FA50902330	302	FA50905530
309	FA50710333	310	FA50713533	305	FA50803233	301	FA50902333	302	FA50905533
309	FA50710501	304	FA50800201	305	FA50803301	301	FA50902501	302	FA50906201
309	FA50710506	304	FA50800206	305	FA50803306	301	FA50902506	302	FA50906206
309	FA50710512	304	FA50800212	305	FA50803312	301	FA50902512	302	FA50906212
309	FA50710518	304	FA50800218	305	FA50803318	301	FA50902518	302	FA50906218
309	FA50710530	304	FA50800230	305	FA50803330	301	FA50902530	302	FA50906230
309	FA50710533	304	FA50800233	305	FA50803333	301	FA50902533	302	FA50906233
309	FA50711201	304	FA50800301	305	FA50803501	301	FA50903201	302	FA50906301
309	FA50711206	304	FA50800306	305	FA50803506	301	FA50903206	302	FA50906306
309	FA50711212	304	FA50800312	305	FA50803512	301	FA50903212	302	FA50906312
309	FA50711218	304	FA50800318	305	FA50803518	301	FA50903218	302	FA50906318
309	FA50711230	304	FA50800330	305	FA50803530	301	FA50903230	302	FA50906330
309	FA50711233	304	FA50800333	305	FA50803533	301	FA50903233	302	FA50906333
309	FA50711301	304	FA50800501	300	FA50900201	301	FA50903301	302	FA50906501
309	FA50711306	304	FA50800506	300	FA50900206	301	FA50903306	302	FA50906506
309	FA50711312	304	FA50800512	300	FA50900212	301	FA50903312	302	FA50906512
309	FA50711318	304	FA50800518	300	FA50900218	301	FA50903318	302	FA50906518
309	FA50711330	304	FA50800530	300	FA50900230	301	FA50903330	302	FA50906530
309	FA50711333	304	FA50800533	300	FA50900233	301	FA50903333	302	FA50906533
309	FA50711501	304	FA50801201	300	FA50900301	301	FA50903501	312	FA51200201
309	FA50711506	304	FA50801206	300	FA50900306	301	FA50903506	312	FA51200206
309	FA50711512	304	FA50801212	300	FA50900312	301	FA50903512	312	FA51200212
309	FA50711518	304	FA50801218	300	FA50900318	301	FA50903518	312	FA51200218
309	FA50711530	304	FA50801230	300	FA50900330	301	FA50903530	312	FA51200230
309	FA50711533	304	FA50801233	300	FA50900333	301	FA50903533	312	FA51200233
310	FA50712201	304	FA50801301	300	FA50900501	302	FA50904201	312	FA51200301
310	FA50712206	304	FA50801306	300	FA50900506	302	FA50904206	312	FA51200306
310	FA50712212	304	FA50801312	300	FA50900512	302	FA50904212	312	FA51200312
310	FA50712218	304	FA50801318	300	FA50900518	302	FA50904218	312	FA51200318
310	FA50712230	304	FA50801330	300	FA50900530	302	FA50904230	312	FA51200330
310	FA50712233	304	FA50801333	300	FA50900533	302	FA50904233	312	FA51200333
310	FA50712301	304	FA50801501	300	FA50901201	302	FA50904301	312	FA51200501
310	FA50712306	304	FA50801506	300	FA50901206	302	FA50904306	312	FA51200506
310	FA50712312	304	FA50801512	300	FA50901212	302	FA50904312	312	FA51200512
310	FA50712318	304	FA50801518	300	FA50901218	302	FA50904318	312	FA51200518
310	FA50712330	304	FA50801530	300	FA50901230	302	FA50904330	312	FA51200530
310	FA50712333	304	FA50801533	300	FA50901233	302	FA50904333	312	FA51200533
310	FA50712501	305	FA50802201	300	FA50901301	302	FA50904501	312	FA51201201
310	FA50712506	305	FA50802206	300	FA50901306	302	FA50904506	312	FA51201206
310	FA50712512	305	FA50802212	300	FA50901312	302	FA50904512	312	FA51201212
310	FA50712518	305	FA50802218	300	FA50901318	302	FA50904518	312	FA51201218
310	FA50712530	305	FA50802230	300	FA50901330	302	FA50904530	312	FA51201230
310	FA50712533	305	FA50802233	300	FA50901333	302	FA50904533	312	FA51201233
310	FA50713201	305	FA50802301	300	FA50901501	302	FA50905201	312	FA51201301
310	FA50713206	305	FA50802306	300	FA50901506	302	FA50905206	312	FA51201306
310	FA50713212	305	FA50802312	300	FA50901512	302	FA50905212	312	FA51201312
310	FA50713218	305	FA50802318	300	FA50901518	302	FA50905218	312	FA51201318
310	FA50713230	305	FA50802330	300	FA50901530	302	FA50905230	312	FA51201330
310	FA50713233	305	FA50802333	300	FA50901533	302	FA50905233	312	FA51201333
310	FA50713301	305							

Page	Reference	Page	Reference	Page	Reference	Page	Reference	Page	Reference
588	FA51300218	590	FA51303818	593	FA51306518	591	FA51309218	386	FA51702530
588	FA51300230	590	FA51303830	593	FA51306530	591	FA51309230	386	FA51702533
588	FA51300233	590	FA51303833	593	FA51306533	591	FA51309233	386	FA51702556
588	FA51300301	590	FA51303901	593	FA51306601	591	FA51309401	386	FA51703201
588	FA51300306	590	FA51303906	593	FA51306606	591	FA51309406	386	FA51703206
588	FA51300312	590	FA51303912	593	FA51306612	591	FA51309412	386	FA51703212
588	FA51300318	590	FA51303918	593	FA51306618	591	FA51309418	386	FA51703218
588	FA51300330	590	FA51303930	593	FA51306630	591	FA51309430	386	FA51703230
588	FA51300333	590	FA51303933	593	FA51306633	591	FA51309433	386	FA51703233
588	FA51301201	591	FA51304701	593	FA51306801	592	FA51309601	386	FA51703256
588	FA51301206	591	FA51304706	593	FA51306806	592	FA51309606	386	FA51703301
588	FA51301212	591	FA51304712	593	FA51306812	592	FA51309612	386	FA51703306
588	FA51301218	591	FA51304718	593	FA51306818	592	FA51309618	386	FA51703312
588	FA51301230	591	FA51304730	593	FA51306830	592	FA51309630	386	FA51703318
588	FA51301233	591	FA51304733	593	FA51306833	592	FA51309633	386	FA51703330
588	FA51301301	591	FA51304801	593	FA51306901	592	FA51309801	386	FA51703333
588	FA51301306	591	FA51304806	593	FA51306906	592	FA51309806	386	FA51703356
588	FA51301312	591	FA51304812	593	FA51306912	592	FA51309812	386	FA51703501
588	FA51301318	591	FA51304818	593	FA51306918	592	FA51309818	386	FA51703506
588	FA51301330	591	FA51304830	593	FA51306930	592	FA51309830	386	FA51703512
588	FA51301333	591	FA51304833	593	FA51306933	592	FA51309833	386	FA51703518
589	FA51302201	591	FA51305001	588	FA51308001	593	FA51310001	386	FA51703530
589	FA51302206	591	FA51305006	588	FA51308006	593	FA51310006	386	FA51703533
589	FA51302212	591	FA51305012	588	FA51308012	593	FA51310012	386	FA51703556
589	FA51302218	591	FA51305018	588	FA51308018	593	FA51310018	387	FA51704201
589	FA51302230	591	FA51305030	588	FA51308030	593	FA51310030	387	FA51704206
589	FA51302233	591	FA51305033	588	FA51308033	593	FA51310033	387	FA51704212
589	FA51302301	591	FA51305101	588	FA51308201	593	FA51310201	387	FA51704218
589	FA51302306	591	FA51305106	588	FA51308206	593	FA51310206	387	FA51704230
589	FA51302312	591	FA51305112	588	FA51308212	593	FA51310212	387	FA51704233
589	FA51302318	591	FA51305118	588	FA51308218	593	FA51310218	387	FA51704256
589	FA51302330	591	FA51305130	588	FA51308230	593	FA51310230	387	FA51704301
589	FA51302333	591	FA51305133	588	FA51308233	593	FA51310233	387	FA51704306
589	FA51303201	592	FA51305901	589	FA51308401	365	FA51700256	387	FA51704312
589	FA51303206	592	FA51305906	589	FA51308406	365	FA51700356	387	FA51704318
589	FA51303212	592	FA51305912	589	FA51308412	365	FA51700556	387	FA51704330
589	FA51303218	592	FA51305918	589	FA51308418	365	FA51701256	387	FA51704333
589	FA51303230	592	FA51305930	589	FA51308430	365	FA51701356	387	FA51704356
589	FA51303233	592	FA51305933	589	FA51308433	365	FA51701456	387	FA51704501
589	FA51303301	592	FA51306001	589	FA51308601	365	FA51701556	387	FA51704506
589	FA51303306	592	FA51306006	589	FA51308606	365	FA51701656	387	FA51704512
589	FA51303312	592	FA51306012	589	FA51308612	365	FA51701756	387	FA51704518
589	FA51303318	592	FA51306018	589	FA51308618	386	FA51702201	387	FA51704530
589	FA51303330	592	FA51306030	589	FA51308630	386	FA51702206	387	FA51704533
589	FA51303333	592	FA51306033	589	FA51308633	386	FA51702212	387	FA51704556
590	FA51303501	592	FA51306201	590	FA51308801	386	FA51702218	387	FA51705201
590	FA51303506	592	FA51306206	590	FA51308806	386	FA51702230	387	FA51705206
590	FA51303512	592	FA51306212	590	FA51308812	386	FA51702233	387	FA51705212
590	FA51303518	592	FA51306218	590	FA51308818	386	FA51702256	387	FA51705218
590	FA51303530	592	FA51306230	590	FA51308830	386	FA51702301	387	FA51705230
590	FA51303533	592	FA51306233	590	FA51308833	386	FA51702306	387	FA51705233
590	FA51303601	592	FA51306301	590	FA51309001	386	FA51702312	387	FA51705256
590	FA51303606	592	FA51306306	590	FA51309006	386	FA51702318	387	FA51705301
590	FA51303612	592	FA51306312	590	FA51309012	386	FA51702330	387	FA51705306
590	FA51303618	592	FA51306318	590	FA51309018	386	FA51702333	387	FA51705312
590	FA51303630	592	FA51306330	590	FA51309030	386	FA51702356	387	FA51705318
590	FA51303633	592	FA51306333	590	FA51309033	386	FA51702501	387	FA51705330
590	FA51303801	593	FA51306501	591	FA51309201	386	FA51702506	387	FA51705333
590	FA51303806	593	FA51306506	591	FA51309206	386	FA51702512	387	FA51705356
590	FA51303812	593	FA51306512	591	FA51309212	386	FA51702518	387	FA51705501

Page	Reference	Page	Reference	Page	Reference	Page	Reference	Page	Reference
387	FA51705506	382	FA51804312	384	FA51808356	473	FA523072	630	FA52501312
387	FA51705512	382	FA51804318	361	FA51820256	473	FA523073	630	FA52501318
387	FA51705518	382	FA51804330	360	FA51820556	470	FA523203	630	FA52501330
387	FA51705530	382	FA51804333	360	FA51820856	470	FA523213	630	FA52501333
387	FA51705533	382	FA51804356	361	FA51821256	471	FA523223	630	FA52502201
387	FA51705556	382	FA51805201	362	FA51821556	471	FA523233	630	FA52502206
388	FA51706201	382	FA51805206	362	FA51822256	472	FA523243	630	FA52502212
388	FA51706206	382	FA51805212	362	FA51822556	472	FA523253	630	FA52502218
388	FA51706212	382	FA51805218	362	FA51823256	473	FA523263	630	FA52502230
388	FA51706218	382	FA51805230	361	FA51823456	473	FA523273	630	FA52502233
388	FA51706230	382	FA51805233	382	FA51824201	407	FA524002	630	FA52502301
388	FA51706233	382	FA51805256	382	FA51824206	407	FA524003	630	FA52502306
388	FA51706256	382	FA51805301	382	FA51824212	407	FA524004	630	FA52502312
388	FA51706301	382	FA51805306	382	FA51824218	407	FA524005	630	FA52502318
388	FA51706306	382	FA51805312	382	FA51824230	406	FA524012	630	FA52502330
388	FA51706312	382	FA51805318	382	FA51824233	406	FA524013	630	FA52502333
388	FA51706318	382	FA51805330	382	FA51824256	406	FA524015	632	FA52503201
388	FA51706330	382	FA51805333	382	FA51825201	406	FA524022	632	FA52503206
388	FA51706333	382	FA51805356	382	FA51825206	406	FA524023	632	FA52503212
388	FA51706356	383	FA51806201	382	FA51825212	406	FA524025	632	FA52503218
388	FA51706501	383	FA51806206	382	FA51825218	411	FA524102	632	FA52503230
388	FA51706506	383	FA51806212	382	FA51825230	411	FA524103	632	FA52503233
388	FA51706512	383	FA51806218	382	FA51825233	411	FA524104	632	FA52503301
388	FA51706518	383	FA51806230	382	FA51825256	411	FA524105	632	FA52503306
388	FA51706530	383	FA51806233	383	FA51826201	410	FA524112	632	FA52503312
388	FA51706533	383	FA51806256	383	FA51826206	410	FA524113	632	FA52503318
388	FA51706556	383	FA51806301	383	FA51826212	410	FA524115	632	FA52503330
364	FA51711256	383	FA51806306	383	FA51826218	410	FA524122	632	FA52503333
364	FA51711356	383	FA51806312	383	FA51826230	410	FA524123	632	FA52504201
364	FA51711556	383	FA51806318	383	FA51826233	410	FA524125	632	FA52504206
364	FA51712256	383	FA51806330	383	FA51826256	409	FA524502	632	FA52504212
364	FA51712356	383	FA51806333	383	FA51827201	409	FA524503	632	FA52504218
364	FA51712556	383	FA51806356	383	FA51827206	409	FA524504	632	FA52504230
361	FA51800256	383	FA51807201	383	FA51827212	409	FA524505	632	FA52504233
361	FA51800356	383	FA51807206	383	FA51827218	408	FA524512	632	FA52504301
360	FA51800556	383	FA51807212	383	FA51827230	408	FA524513	632	FA52504306
360	FA51800656	383	FA51807218	383	FA51827233	408	FA524515	632	FA52504312
360	FA51800856	383	FA51807230	383	FA51827256	408	FA524522	632	FA52504318
360	FA51800956	383	FA51807233	384	FA51828201	408	FA524523	632	FA52504330
361	FA51801256	383	FA51807256	384	FA51828206	408	FA524525	632	FA52504333
361	FA51801356	383	FA51807301	384	FA51828212	630	FA52500201	632	FA52505201
362	FA51801556	383	FA51807306	384	FA51828218	630	FA52500206	632	FA52505206
362	FA51801656	383	FA51807312	384	FA51828230	630	FA52500212	632	FA52505212
362	FA51802256	383	FA51807318	384	FA51828233	630	FA52500218	632	FA52505218
362	FA51802356	383	FA51807330	384	FA51828256	630	FA52500230	632	FA52505230
362	FA51802556	383	FA51807333	584	FA5230	630	FA52500233	632	FA52505233
362	FA51802656	383	FA51807356						

Page	Reference	Page	Reference	Page	Reference	Page	Reference	Page	Reference
635	FA52506212-310	635	FA52507330-310	634	FA52509301-310	641	FA52511212-310	640	FA52512330-310
635	FA52506218	635	FA52507333	634	FA52509306	641	FA52511218	640	FA52512333
635	FA52506218-300	635	FA52507333-300	634	FA52509306-300	641	FA52511218-300	640	FA52512333-300
635	FA52506218-310	635	FA52507333-310	634	FA52509306-310	641	FA52511218-310	640	FA52512333-310
635	FA52506230	634	FA52508201	634	FA52509312	641	FA52511230	642	FA52512401
635	FA52506230-300	634	FA52508201-300	634	FA52509312-300	641	FA52511230-300	642	FA52512406
635	FA52506230-310	634	FA52508201-310	634	FA52509312-310	641	FA52511230-310	642	FA52512412
635	FA52506233	634	FA52508206	634	FA52509318	641	FA52511233	642	FA52512418
635	FA52506233-300	634	FA52508206-300	634	FA52509318-300	641	FA52511233-300	642	FA52512430
635	FA52506233-310	634	FA52508206-310	634	FA52509318-310	641	FA52511233-310	642	FA52512433
635	FA52506301	634	FA52508212	634	FA52509330	641	FA52511301	640	FA52513201
635	FA52506301-300	634	FA52508212-300	634	FA52509330-300	641	FA52511301-300	640	FA52513201-300
635	FA52506301-310	634	FA52508212-310	634	FA52509330-310	641	FA52511301-310	640	FA52513201-310
635	FA52506306	634	FA52508218	634	FA52509333	641	FA52511306	640	FA52513206
635	FA52506306-300	634	FA52508218-300	634	FA52509333-300	641	FA52511306-300	640	FA52513206-300
635	FA52506306-310	634	FA52508218-310	634	FA52509333-310	641	FA52511306-310	640	FA52513206-310
635	FA52506312	634	FA52508230	641	FA52510201	641	FA52511312	640	FA52513212
635	FA52506312-300	634	FA52508230-300	641	FA52510201-300	641	FA52511312-300	640	FA52513212-300
635	FA52506312-310	634	FA52508230-310	641	FA52510201-310	641	FA52511312-310	640	FA52513212-310
635	FA52506318	634	FA52508233	641	FA52510206	641	FA52511318	640	FA52513218
635	FA52506318-300	634	FA52508233-300	641	FA52510206-300	641	FA52511318-300	640	FA52513218-300
635	FA52506318-310	634	FA52508233-310	641	FA52510206-310	641	FA52511318-310	640	FA52513218-310
635	FA52506330	634	FA52508301	641	FA52510212	641	FA52511330	640	FA52513230
635	FA52506330-300	634	FA52508301-300	641	FA52510212-300	641	FA52511330-300	640	FA52513230-300
635	FA52506330-310	634	FA52508301-310	641	FA52510212-310	641	FA52511330-310	640	FA52513230-310
635	FA52506333	634	FA52508306	641	FA52510218	641	FA52511333	640	FA52513233
635	FA52506333-300	634	FA52508306-300	641	FA52510218-300	641	FA52511333-300	640	FA52513233-300
635	FA52506333-310	634	FA52508306-310	641	FA52510218-310	641	FA52511333-310	640	FA52513233-310
635	FA52507201	634	FA52508312	641	FA52510230	640	FA52512201	640	FA52513301
635	FA52507201-300	634	FA52508312-300	641	FA52510230-300	640	FA52512201-300	640	FA52513301-300
635	FA52507201-310	634	FA52508312-310	641	FA52510230-310	640	FA52512201-310	640	FA52513301-310
635	FA52507206	634	FA52508318	641	FA52510233	640	FA52512206	640	FA52513306
635	FA52507206-300	634	FA52508318-300	641	FA52510233-300	640	FA52512206-300	640	FA52513306-300
635	FA52507206-310	634	FA52508318-310	641	FA52510233-310	640	FA52512206-310	640	FA52513306-310
635	FA52507212	634	FA52508330	641	FA52510301	640	FA52512212	640	FA52513312
635	FA52507212-300	634	FA52508330-300	641	FA52510301-300	640	FA52512212-300	640	FA52513312-300
635	FA52507212-310	634	FA52508330-310	641	FA52510301-310	640	FA52512212-310	640	FA52513312-310
635	FA52507218	634	FA52508333	641	FA52510306	640	FA52512218	640	FA52513318
635	FA52507218-300	634	FA52508333-300	641	FA52510306-300	640	FA52512218-300	640	FA52513318-300
635	FA52507218-310	634	FA52508333-310	641	FA52510306-310	640	FA52512218-310	640	FA52513318-310
635	FA52507230	634	FA52509201	641	FA52510312	640	FA52512230	640	FA52513330
635	FA52507230-300	634	FA52509201-300	641	FA52510312-300	640	FA52512230-300	640	FA52513330-300
635	FA52507230-310	634	FA52509201-310	641	FA52510312-310	640	FA52512230-310	640	FA52513330-310
635	FA52507233	634	FA52509206	641	FA52510318	640	FA52512233	640	FA52513333
635	FA52507233-300	634	FA52509206-300	641	FA52510318-300	640	FA52512233-300	640	FA52513333-300
635	FA52507233-310	634	FA52509206-310	641	FA52510318-310	640	FA52512233-310	640	FA52513333-310
635	FA52507301	634	FA52509212	641	FA52510330	640	FA52512301	630	FA52514001
635	FA52507301-300	634	FA52509212-300	641	FA52510330-300	640	FA52512301-300	630	FA52514006
635	FA52507301-310	634	FA52509212-310	641	FA52510330-310	640	FA52512301-310	630	FA52514012
635	FA52507306	634	FA52509218	641	FA52510333	640	FA52512306	630	FA52514018
635	FA52507306-300	634	FA52509218-300	641	FA52510333-300	640	FA52512306-300	630	FA52514030
635	FA52507306-310	634	FA52509218-310	641	FA52510333-310	640	FA52512306-310	630	FA52514033
635	FA52507312	634	FA52509230	641	FA52511201	640	FA52512312	630	FA52514201
635	FA52507312-300	634	FA52509230-300	641	FA52511201-300	640	FA52512312-300	630	FA52514206
635	FA52507312-310	634	FA52509230-310	641	FA52511201-310	640	FA52512312-310	630	FA52514212
635	FA52507318	634	FA52509233	641	FA52511206	640	FA52512318	630	FA52514218
635	FA52507318-300	634	FA52509233-300	641	FA52511206-300	640	FA52512318-300	630	FA52514230
635	FA52507318-310	634	FA52509233-310	641	FA52511206-310	640	FA52512318-310	630	FA52514233
635	FA52507330	634	FA52509301	641	FA52511212	640	FA52512330	630	FA52514401
635	FA52507330-300	634	FA52509301-300	641	FA52511212-300	640	FA52512330-300	630	FA52514406

Page	Reference	Page	Reference	Page	Reference	Page	Reference	Page	Reference
630	FA52514412	635	FA52515601-310	640	FA52516212-310	495	FA52600512	533	FA53100830
630	FA52514418	635	FA52515606	640	FA52516218	495	FA52600518	533	FA53100830-300
630	FA52514430	635	FA52515606-300	640	FA52516218-300	495	FA52600530	533	FA53100830-310
630	FA52514433	635	FA52515606-310	640	FA52516218-310	495	FA52600533	533	FA53100833
632	FA52514601	635	FA52515612	640	FA52516230	504	FA52700201	533	FA53100833-300
632	FA52514606	635	FA52515612-300	640	FA52516230-300	504	FA52700206	533	FA53100833-310
632	FA52514612	635	FA52515612-310	640	FA52516230-310	504	FA52700212	533	FA53100901
632	FA52514618	635	FA52515618	640	FA52516233	504	FA52700218	533	FA53100901-300
632	FA52514630	635	FA52515618-300	640	FA52516233-300	504	FA52700230	533	FA53100901-310
632	FA52514633	635	FA52515618-310	640	FA52516233-310	504	FA52700233	533	FA53100906
632	FA52514801	635	FA52515630	641	FA52516401	504	FA52700301	533	FA53100906-300
632	FA52514806	635	FA52515630-300	641	FA52516401-300	504	FA52700306	533	FA53100906-310
632	FA52514812	635	FA52515630-310	641	FA52516401-310	504	FA52700312	533	FA53100912
632	FA52514818	635	FA52515633	641	FA52516406	504	FA52700318	533	FA53100912-300
632	FA52514830	635	FA52515633-300	641	FA52516406-300	504	FA52700330	533	FA53100912-310
632	FA52514833	635	FA52515633-310	641	FA52516406-310	504	FA52700333	533	FA53100918
632	FA52515001	635	FA52515801	641	FA52516412	504	FA52700501	533	FA53100918-300
632	FA52515006	635	FA52515801-300	641	FA52516412-300	504	FA52700506	533	FA53100918-310
632	FA52515012	635	FA52515801-310	641	FA52516412-310	504	FA52700512	533	FA53100930
632	FA52515018	635	FA52515806	641	FA52516418	504	FA52700518	533	FA53100930-300
632	FA52515030	635	FA52515806-300	641	FA52516418-300	504	FA52700530	533	FA53100930-310
632	FA52515033	635	FA52515806-310	641	FA52516418-310	504	FA52700533	533	FA53100933
634	FA52515201	635	FA52515812	641	FA52516430	504	FA52701201	533	FA53100933-300
634	FA52515201-300	635	FA52515812-300	641	FA52516430-300	504	FA52701206	533	FA53100933-310
634	FA52515201-310	635	FA52515812-310	641	FA52516430-310	504	FA52701212	533	FA53101101
634	FA52515206	635	FA52515818	641	FA52516433	504	FA52701218	533	FA53101101-300
634	FA52515206-300	635	FA52515818-300	641	FA52516433-300	504	FA52701230	533	FA53101101-310
634	FA52515206-310	635	FA52515818-310	641	FA52516433-310	504	FA52701233	533	FA53101106
634	FA52515212	635	FA52515830	641	FA52516601	504	FA52701301	533	FA53101106-300
634	FA52515212-300	635	FA52515830-300	641	FA52516601-300	504	FA52701306	533	FA53101106-310
634	FA52515212-310	635	FA52515830-310	641	FA52516601-310	504	FA52701312	533	FA53101112
634	FA52515218	635	FA52515833	641	FA52516606	504	FA52701318	533	FA53101112-300
634	FA52515218-300	635	FA52515833-300	641	FA52516606-300	504	FA52701330	533	FA53101112-310
634	FA52515218-310	635	FA52515833-310	641	FA52516606-310	504	FA52701333	533	FA53101118
634	FA52515230	640	FA52516001	641	FA52516612	504	FA52701501	533	FA53101118-300
634	FA52515230-300	640	FA52516001-300	641	FA52516612-300	504	FA52701506	533	FA53101118-310
634	FA52515230-310	640	FA52						

Page	Reference	Page	Reference	Page	Reference	Page	Reference	Page	Reference
535	FA53102001	535	FA53102512	533	FA53120901	535	FA53122412	224	FA53200501
535	FA53102001-300	535	FA53102512-300	533	FA53120901-300	535	FA53122412-300	224	FA53200501-300
535	FA53102001-310	535	FA53102512-310	533	FA53120901-310	535	FA53122412-310	224	FA53200501-310
535	FA53102006	535	FA53102518	533	FA53120906	535	FA53122418	224	FA53200506
535	FA53102006-300	535	FA53102518-300	533	FA53120906-300	535	FA53122418-300	224	FA53200506-300
535	FA53102006-310	535	FA53102518-310	533	FA53120906-310	535	FA53122418-310	224	FA53200506-310
535	FA53102012	535	FA53102530	533	FA53120912	535	FA53122430	224	FA53200512
535	FA53102012-300	535	FA53102530-300	533	FA53120912-300	535	FA53122430-300	224	FA53200512-300
535	FA53102012-310	535	FA53102530-310	533	FA53120912-310	535	FA53122430-310	224	FA53200512-310
535	FA53102018	535	FA53102533	533	FA53120918	535	FA53122433	224	FA53200518
535	FA53102018-300	535	FA53102533-300	533	FA53120918-300	535	FA53122433-300	224	FA53200518-300
535	FA53102018-310	535	FA53102533-310	533	FA53120918-310	535	FA53122433-310	224	FA53200518-310
535	FA53102030	532	FA53102901	533	FA53120930	532	FA53124201	224	FA53200530
535	FA53102030-300	532	FA53102906	533	FA53120930-300	532	FA53124206	224	FA53200530-300
535	FA53102030-310	532	FA53102912	533	FA53120930-310	532	FA53124212	224	FA53200530-310
535	FA53102033	532	FA53102918	533	FA53120933	532	FA53124218	224	FA53200533
535	FA53102033-300	532	FA53102930	533	FA53120933-300	532	FA53124230	224	FA53200533-300
535	FA53102033-310	532	FA53102933	533	FA53120933-310	532	FA53124233	224	FA53200533-310
535	FA53102101	532	FA53103001	533	FA53121201	532	FA53124401	224	FA53200601
535	FA53102101-300	532	FA53103006	533	FA53121201-300	532	FA53124406	224	FA53200601-300
535	FA53102101-310	532	FA53103012	533	FA53121201-310	532	FA53124412	224	FA53200601-310
535	FA53102106	532	FA53103018	533	FA53121206	532	FA53124418	224	FA53200606
535	FA53102106-300	532	FA53103030	533	FA53121206-300	532	FA53124430	224	FA53200606-300
535	FA53102106-310	532	FA53103033	533	FA53121206-310	532	FA53124433	224	FA53200606-310
535	FA53102112	534	FA53103101	533	FA53121212	224	FA53200201	224	FA53200612
535	FA53102112-300	534	FA53103106	533	FA53121212-300	224	FA53200201-300	224	FA53200612-300
535	FA53102112-310	534	FA53103112	533	FA53121212-310	224	FA53200201-310	224	FA53200612-310
535	FA53102118	534	FA53103118	533	FA53121218	224	FA53200206	224	FA53200618
535	FA53102118-300	534	FA53103130	533	FA53121218-300	224	FA53200206-300	224	FA53200618-300
535	FA53102118-310	534	FA53103133	533	FA53121218-310	224	FA53200206-310	224	FA53200618-310
535	FA53102130	534	FA53103201	533	FA53121230	224	FA53200212	224	FA53200630
535	FA53102130-300	534	FA53103206	533	FA53121230-300	224	FA53200212-300	224	FA53200630-300
535	FA53102130-310	534	FA53103212	533	FA53121230-310	224	FA53200212-310	224	FA53200630-310
535	FA53102133	534	FA53103218	533	FA53121233	224	FA53200218	224	FA53200633
535	FA53102133-300	534	FA53103230	533	FA53121233-300	224	FA53200218-300	224	FA53200633-300
535	FA53102133-310	534	FA53103233	533	FA53121233-310	224	FA53200218-310	224	FA53200633-310
535	FA53102401	532	FA53104101	535	FA53122101	224	FA53200230	225	FA53200801
535	FA53102401-300	532	FA53104106	535	FA53122101-300	224	FA53200230-300	225	FA53200801-300
535	FA53102401-310	532	FA53104112	535	FA53122101-310	224	FA53200230-310	225	FA53200801-310
535	FA53102406	532	FA53104118	535	FA53122106	224	FA53200233	225	FA53200806
535	FA53102406-300	532	FA53104130	535	FA53122106-300	224	FA53200233-300	225	FA53200806-300
535	FA53102406-310	532	FA53104133	535	FA53122106-310	224	FA53200233-310	225	FA53200806-310
535	FA53102412	532	FA53104201	535	FA53122112	224	FA53200301	225	FA53200812
535	FA53102412-300	532	FA53104206	535	FA53122112-300	224	FA53200301-300	225	FA53200812-300
535	FA53102412-310	532	FA53104212	535	FA53122112-310	224	FA53200301-310	225	FA53200812-310
535	FA53102418	532	FA53104218	535	FA53122118	224	FA53200306	225	FA53200818
535	FA53102418-300	532	FA53104230	535	FA53122118-300	224	FA53200306-300	225	FA53200818-300
535	FA53102418-310	532	FA53104233	535	FA53122118-310	224	FA53200306-310	225	FA53200818-310
535	FA53102430	532	FA53104301	535	FA53122130	224	FA53200312	225	FA53200830
535	FA53102430-300	532	FA53104306	535	FA53122130-300	224	FA53200312-300	225	FA53200830-300
535	FA53102430-310	532	FA53104312	535	FA53122130-310	224	FA53200312-310	225	FA53200830-310
535	FA53102433	532	FA53104318	535	FA53122133	224	FA53200318	225	FA53200833
535	FA53102433-300	532	FA53104330	535	FA53122133-300	224	FA53200318-300	225	FA53200833-300
535	FA53102433-310	532	FA53104333	535	FA53122133-310	224	FA53200318-310	225	FA53200833-310
535	FA53102501	532	FA53104401	535	FA53122401	224	FA53200330	225	FA53200901
535	FA53102501-300	532	FA53104406	535	FA53122401-300	224	FA53200330-300	225	FA53200901-300
535	FA53102501-310	532	FA53104412	535	FA53122401-310	224	FA53200330-310	225	FA53200901-310
535	FA53102506	532	FA53104418	535	FA53122406	224	FA53200333	225	FA53200906
535	FA53102506-300	532	FA53104430	535	FA53122406-300	224	FA53200333-300	225	FA53200906-300
535	FA53102506-310	532	FA53104433	535	FA53122406-310	224	FA53200333-310	225	FA53200906-310

Page	Reference	Page	Reference	Page	Reference	Page	Reference	Page	Reference
225	FA53200912	225	FA53202030	514	FA53302112	514	FA53305212	514	FA533421
225	FA53200912-300	225	FA53202030-300	514	FA53302112-300	514	FA53305212-300	514	FA533421-300
225	FA53200912-310	225	FA53202030-310	514	FA53302112-310	514	FA53305212-310	514	FA533421-310
225	FA53200918	225	FA53202033	514	FA53302118	514	FA53305218	515	FA533422
225	FA53200918-300	225	FA53202033-300	514	FA53302118-300	514	FA53305218-300	515	FA533422-300
225	FA53200918-310	225	FA53202033-310	514	FA53302118-310	514	FA53305218-310	515	FA533422-310
225	FA53200930	518	FA53300101	514	FA53302130	514	FA53305230	515	FA533423
225	FA53200930-300	518	FA53300106	514	FA53302130-300	514	FA53305230-300	515	FA533423-300
225	FA53200930-310	518	FA53300112	514	FA53302130-310	514	FA53305230-310	515	FA533423-310
225	FA53200933	518	FA53300118	514	FA53302133	514	FA53305233	515	FA533424
225	FA53200933-300	518	FA53300130	514	FA53302133-300	514	FA53305233-300	515	FA533424-300
225	FA53200933-310	518	FA53300133	514	FA53302133-310	514	FA53305233-310	515	FA533424-310
224	FA53201401	518	FA53300201	514	FA53302201	518	FA533221	514	FA533431
224	FA53201401-300	518	FA53300206	514	FA53302201-300	518	FA533222	514	FA533431-300
224	FA53201401-310	518	FA53300212	514	FA53302201-310	519	FA533223	514	FA533431-310
224	FA53201406	518	FA53300218	514	FA53302206	519	FA533224	515	FA533432
224	FA53201406-300	518	FA53300230	514	FA53302206-300	518	FA533231	515	FA533432-300
224	FA53201406-310	518	FA53300233	514	FA53302206-310	518	FA533232	515	FA533432-310
224	FA53201412	516	FA53301101	514	FA53302212	519	FA533233	515	FA533433
224	FA53201412-300	516	FA53301101-300	514	FA53302212-300	519	FA533234	515	FA533433-300
224	FA53201412-310	516	FA53301101-310	514	FA53302212-310	518	FA533241	515	FA533433-310
224	FA53201418	516	FA53301106	514	FA53302218	518	FA533242	515	FA533434
224	FA53201418-300	516	FA53301106-300	514	FA53302218-300	519	FA533243	515	FA533434-300
224	FA53201418-310	516	FA53301106-310	514	FA53302218-310	519	FA533244	515	FA533434-310
224	FA53201430	516	FA53301112	514	FA53302230	516	FA533321	514	FA533441
224	FA53201430-300	516	FA53301112-300	514	FA53302230-300	516	FA533321-300	514	FA533441-300
224	FA53201430-310	516	FA53301112-310	514	FA53302230-310	516	FA533321-310	514	FA533441-310
224	FA53201433	516	FA53301118	514	FA53302233	517	FA533322	515	FA533442
224	FA53201433-300	516	FA53301118-300	514	FA53302233-300	517	FA533322-300	515	FA533442-300
224	FA53201433-310	516	FA53301118-310	514	FA53302233-310	517	FA533322-310	515	FA533442-310
224	FA53201701	516	FA53301130	518	FA53305001	517	FA533323	515	FA533443
224	FA53201701-300	516	FA53301130-300	518	FA53305006	517	FA533323-300	515	FA533443-300
224	FA53201701-310	516	FA53301130-310	518	FA53305012	517	FA533323-310	515	FA533443-310
224	FA53201706	516	FA53301133	518	FA53305018	517	FA533324	515	FA533444
224	FA53201706-300	516	FA53301133-300	518	FA53305030	517	FA533324-300	515	FA533444-300
224	FA53201706-310	516	FA53301133-310	518	FA53305033	517	FA533324-310	515	FA533444-310
224	FA53201712	516	FA53301201	516	FA53305101	516	FA533331	354	FA53400256

Page	Reference	Page	Reference	Page	Reference	Page	Reference	Page	Reference
352	FA53402656	352	FA53405756	379	FA53500818	377	FA53502318	375	FA53504118
352	FA53402656-300	352	FA53405756-300	379	FA53500830	377	FA53502330	375	FA53504130
352	FA53402656-310	352	FA53405756-310	379	FA53500833	377	FA53502333	375	FA53504133
352	FA53402756	352	FA53405856	379	FA53500901	377	FA53502401	375	FA53504201
352	FA53402756-300	352	FA53405856-300	379	FA53500906	377	FA53502406	375	FA53504206
352	FA53402756-310	352	FA53405856-310	379	FA53500912	377	FA53502412	375	FA53504212
353	FA53402956	352	FA53405956	379	FA53500918	377	FA53502418	375	FA53504218
353	FA53402956-300	352	FA53405956-300	379	FA53500930	377	FA53502430	375	FA53504230
353	FA53402956-310	352	FA53405956-310	379	FA53500933	377	FA53502433	375	FA53504233
353	FA53403056	353	FA53406056	374	FA53501101	379	FA53502601	377	FA53504301
353	FA53403056-300	353	FA53406056-300	374	FA53501106	379	FA53502606	377	FA53504306
353	FA53403056-310	353	FA53406056-310	374	FA53501112	379	FA53502612	377	FA53504312
353	FA53403156	353	FA53406156	374	FA53501118	379	FA53502618	377	FA53504318
353	FA53403156-300	353	FA53406156-300	374	FA53501130	379	FA53502630	377	FA53504330
353	FA53403156-310	353	FA53406156-310	374	FA53501133	379	FA53502633	377	FA53504333
353	FA53403256	353	FA53406256	374	FA53501201	379	FA53502701	377	FA53504401
353	FA53403256-300	353	FA53406256-300	374	FA53501206	379	FA53502706	377	FA53504406
353	FA53403256-310	353	FA53406256-310	374	FA53501212	379	FA53502712	377	FA53504412
353	FA53403356	350	FA53406356	374	FA53501218	379	FA53502718	377	FA53504418
353	FA53403356-300	350	FA53406356-300	374	FA53501230	379	FA53502730	377	FA53504430
353	FA53403356-310	350	FA53406356-310	374	FA53501233	379	FA53502733	377	FA53504433
353	FA53403456	350	FA53406456	376	FA53501401	374	FA53502901	379	FA53504501
353	FA53403456-300	350	FA53406456-300	376	FA53501406	374	FA53502906	379	FA53504506
353	FA53403456-310	350	FA53406456-310	376	FA53501412	374	FA53502912	379	FA53504512
350	FA53403656	350	FA53406556	376	FA53501418	374	FA53502918	379	FA53504518
350	FA53403656-300	350	FA53406556-300	376	FA53501430	374	FA53502930	379	FA53504530
350	FA53403656-310	350	FA53406556-310	376	FA53501433	374	FA53502933	379	FA53504533
350	FA53403756	351	FA53406656	376	FA53501501	374	FA53503001	379	FA53504601
350	FA53403756-300	351	FA53406656-300	376	FA53501506	374	FA53503006	379	FA53504606
350	FA53403756-310	351	FA53406656-310	376	FA53501512	374	FA53503012	379	FA53504612
350	FA53403956	351	FA53406756	376	FA53501518	374	FA53503018	379	FA53504618
350	FA53403956-300	351	FA53406756-300	376	FA53501530	374	FA53503030	379	FA53504630
350	FA53403956-310	351	FA53406756-310	376	FA53501533	374	FA53503033	379	FA53504633
350	FA53404056	375	FA53500201	378	FA53501701	376	FA53503201	374	FA53504701
350	FA53404056-300	375	FA53500206	378	FA53501706	376	FA53503206	374	FA53504706
350	FA53404056-310	375	FA53500212	378	FA53501712	376	FA53503212	374	FA53504712
350	FA53404256	375	FA53500218	378	FA53501718	376	FA53503218	374	FA53504718
350	FA53404256-300	375	FA53500230	378	FA53501730	376	FA53503230	374	FA53504730
350	FA53404256-310	375	FA53500233	378	FA53501733	376	FA53503233	374	FA53504733
350	FA53404356	375	FA53500301	378	FA53501801	376	FA53503301	374	FA53504801
350	FA53404356-300	375	FA53500306	378	FA53501806	376	FA53503306	374	FA53504806
350	FA53404356-310	375	FA53500312	378	FA53501812	376	FA53503312	374	FA53504812
351	FA53404556	375	FA53500318	378	FA53501818	376	FA53503318	374	FA53504818
351	FA53404556-300	375	FA53500330	378	FA53501830	376	FA53503330	374	FA53504830
351	FA53404556-310	375	FA53500333	378	FA53501833	376	FA53503333	374	FA53504833
351	FA53404656	377	FA53500501	375	FA53502001	378	FA53503501	376	FA53504901
351	FA53404656-300	377	FA53500506	375	FA53502006	378	FA53503506	376	FA53504906
351	FA53404656-310	377	FA53500512	375	FA53502012	378	FA53503512	376	FA53504912
351	FA53404756	377	FA53500518	375	FA53502018	378	FA53503518	376	FA53504918
351	FA53404756-300	377	FA53500530	375	FA53502030	378	FA53503530	376	FA53504930
351	FA53404756-310	377	FA53500533	375	FA53502033	378	FA53503533	376	FA53504933
351	FA53404856	377	FA53500601	375	FA53502101	378	FA53503601	376	FA53505001
351	FA53404856-300	377	FA53500606	375	FA53502106	378	FA53503606	376	FA53505006
351	FA53404856-310	377	FA53500612	375	FA53502112	378	FA53503612	376	FA53505012
354	FA53405156	377	FA53500618	375	FA53502118	378	FA53503618	376	FA53505018
354	FA53405256	377	FA53500630	375	FA53502130	378	FA53503630	376	FA53505030
354	FA53405356	377	FA53500633	375	FA53502133	378	FA53503633	376	FA53505033
355	FA53405456	379	FA53500801	377	FA53502301	375	FA53504101	378	FA53505101
355	FA53405556	379	FA53500806	377	FA53502306	375	FA53504106	378	FA53505106
355	FA53405656	379	FA53500812	377	FA53502312	375	FA53504112	378	FA53505112

Page	Reference	Page	Reference	Page	Reference	Page	Reference	Page	Reference
378	FA53505118	543	FA53602701-300	545	FA53604956-300	544	FA53613256	659	FA53900633
378	FA53505130	543	FA53602701-310	545	FA53604956-310	544	FA53613256-300	659	FA53900633-300
378	FA53505133	543	FA53602801	545	FA53605056	544	FA53613256-310	659	FA53900633-310
378	FA53505201	543	FA53602801-300	545	FA53605056-300	544	FA53613456	659	FA53900806
378	FA53505206	543	FA53602801-310	545	FA53605056-310	544	FA53613456-300	659	FA53900806-300
378	FA53505212	544	FA53602956	545	FA53605156	544	FA53613456-310	659	FA53900806-310
378	FA53505218	544	FA53602956-300	545	FA53605156-300	544	FA53613656	659	FA53900833
378	FA53505230	544	FA53602956-310	545	FA53605156-310	544	FA53613656-300	659	FA53900833-300
378	FA53505233	544	FA53603056	545	FA53605256	544	FA53613656-310	659	FA53900833-310
542	FA53600256	544	FA53603056-300	545	FA53605256-300	544	FA53613801	659	FA53900906
542	FA53600356	544	FA53603056-310	545	FA53605256-310	544	FA53613801-300	659	FA53900906-300
542	FA53600556	544	FA53603156	545	FA53605501	544	FA53613801-310	659	FA53900906-310
542	FA53600656	544	FA53603156-300	545	FA53605501-300	544	FA53614001	659	FA53900933
542	FA53600801	544	FA53603156-310	545	FA53605501-310	544	FA53614001-300	659	FA53900933-300
542	FA53600901	544	FA53603256	545	FA53605601	544	FA53614001-310	659	FA53900933-310
542	FA53601101	544	FA53603256-300	545	FA53605601-300	544	FA53614201	660	FA53901106
542	FA53601201	544	FA53603256-310	545	FA53605601-310	544	FA53614201-300	660	FA53901106-300
543	FA53601356	544	FA53603356	545	FA53605701	544	FA53614201-310	660	FA53901106-310
543	FA53601356-300	544	FA53603356-300	545	FA53605701-300	544	FA53614401	660	FA53901133
543	FA53601356-310	544	FA53603356-310	545	FA53605701-310	544	FA53614401-300	660	FA53901133-300
543	FA53601456	544	FA53603456	545	FA53605801	544	FA53614401-310	660	FA53901133-310
543	FA53601456-300	544	FA53603456-300	545	FA53605801-300	545	FA53614856	660	FA53901206
543	FA53601456-310	544	FA53603456-310	545	FA53605801-310	545	FA53614856-300	660	FA53901206-300
543	FA53601556	544	FA53603556	545	FA53605901	545	FA53614856-310	660	FA53901206-310
543	FA53601556-300	544	FA53603556-300	545	FA53605901-300	545	FA53615056	660	FA53901233
543	FA53601556-310	544	FA53603556-310	545	FA53605901-310	545	FA53615056-300	660	FA53901233-300
543	FA53601656	544	FA53603656	545	FA53606001	545	FA53615056-310	660	FA53901233-310
543	FA53601656-300	544	FA53603656-300	545	FA53606001-300	545	FA53615256	660	FA53901406
543	FA53601656-310	544	FA53603656-310	545	FA53606001-310	545	FA53615256-300	660	FA53901406-300
543	FA53601756	544	FA53603701	542	FA53610356	545	FA53615256-310	660	FA53901406-310
543	FA53601756-300	544	FA53603701-300	542	FA53610656	545	FA53615601	660	FA53901433
543	FA53601756-310	544	FA53603701-310	542	FA53610901	545	FA53615601-300	660	FA53901433-300
543	FA53601856	544	FA53603801	542	FA53611201	545	FA53615601-310	660	FA53901433-310
543	FA53601856-300	544	FA53603801-300	543	FA53611456	545	FA53615801	660	FA53901506
543	FA53601856-310	544	FA53603801-310	543	FA53611456-300	545	FA53615801-300	660	FA53901506-300
543	FA53601956	544	FA53603901	543	FA53611456-310	545	FA53615801-310	660	FA53901506-310
543	FA53601956-300	544	FA53603901-300	543	FA53611656	545	FA53616001	660	FA53901533
543	FA53601956-310	544	FA53603901-310	543	FA53611656-300	545	FA53616001-300	660	FA53901533-300
543	FA53602056	544	FA53604001	543	FA53611656-310	545	FA53616001-310	660	FA53901533-310
543	FA53602056-300	544	FA53604001-300	543	FA5361185				

Page	Reference	Page	Reference	Page	Reference	Page	Reference	Page	Reference
661	FA53902133	662	FA53903633	656	FA53905133	658	FA53906633	655	FA53908233
661	FA53902133-300	662	FA53903633-300	656	FA53905133-300	658	FA53906633-300	655	FA53908233-300
661	FA53902133-310	662	FA53903633-310	656	FA53905133-310	658	FA53906633-310	655	FA53908233-310
661	FA53902306	655	FA53903806	656	FA53905306	658	FA53906806	656	FA53908406
661	FA53902306-300	655	FA53903806-300	656	FA53905306-300	658	FA53906806-300	656	FA53908406-300
661	FA53902306-310	655	FA53903806-310	656	FA53905306-310	658	FA53906806-310	656	FA53908406-310
661	FA53902333	655	FA53903833	656	FA53905333	658	FA53906833	656	FA53908433
661	FA53902333-300	655	FA53903833-300	656	FA53905333-300	658	FA53906833-300	656	FA53908433-300
661	FA53902333-310	655	FA53903833-310	656	FA53905333-310	658	FA53906833-310	656	FA53908433-310
661	FA53902406	655	FA53903906	656	FA53905406	658	FA53906906	656	FA53908606
661	FA53902406-300	655	FA53903906-300	656	FA53905406-300	658	FA53906906-300	656	FA53908606-300
661	FA53902406-310	655	FA53903906-310	656	FA53905406-310	658	FA53906906-310	656	FA53908606-310
661	FA53902433	655	FA53903933	656	FA53905433	658	FA53906933	656	FA53908633
661	FA53902433-300	655	FA53903933-300	656	FA53905433-300	658	FA53906933-300	656	FA53908633-300
661	FA53902433-310	655	FA53903933-310	656	FA53905433-310	658	FA53906933-310	656	FA53908633-310
661	FA53902606	655	FA53904106	657	FA53905606	658	FA53907106	656	FA53908806
661	FA53902606-300	655	FA53904106-300	657	FA53905606-300	658	FA53907106-300	656	FA53908806-300
661	FA53902606-310	655	FA53904106-310	657	FA53905606-310	658	FA53907106-310	656	FA53908806-310
661	FA53902633	655	FA53904133	657	FA53905633	658	FA53907133	656	FA53908833
661	FA53902633-300	655	FA53904133-300	657	FA53905633-300	658	FA53907133-300	656	FA53908833-300
661	FA53902633-310	655	FA53904133-310	657	FA53905633-310	658	FA53907133-310	656	FA53908833-310
661	FA53902706	655	FA53904206	657	FA53905706	658	FA53907206	657	FA53909006
661	FA53902706-300	655	FA53904206-300	657	FA53905706-300	658	FA53907206-300	657	FA53909006-300
661	FA53902706-310	655	FA53904206-310	657	FA53905706-310	658	FA53907206-310	657	FA53909006-310
661	FA53902733	655	FA53904233	657	FA53905733	658	FA53907233	657	FA53909033
661	FA53902733-300	655	FA53904233-300	657	FA53905733-300	658	FA53907233-300	657	FA53909033-300
661	FA53902733-310	655	FA53904233-310	657	FA53905733-310	658	FA53907233-310	657	FA53909033-310
662	FA53902906	655	FA53904406	657	FA53905906	654	FA53907406	657	FA53909206
662	FA53902906-300	655	FA53904406-300	657	FA53905906-300	654	FA53907406-300	657	FA53909206-300
662	FA53902906-310	655	FA53904406-310	657	FA53905906-310	654	FA53907406-310	657	FA53909206-310
662	FA53902933	655	FA53904433	657	FA53905933	654	FA53907433	657	FA53909233
662	FA53902933-300	655	FA53904433-300	657	FA53905933-300	654	FA53907433-300	657	FA53909233-300
662	FA53902933-310	655	FA53904433-310	657	FA53905933-310	654	FA53907433-310	657	FA53909233-310
662	FA53903006	655	FA53904506	657	FA53906006	654	FA53907506	657	FA53909406
662	FA53903006-300	655	FA53904506-300	657	FA53906006-300	654	FA53907506-300	657	FA53909406-300
662	FA53903006-310	655	FA53904506-310	657	FA53906006-310	654	FA53907506-310	657	FA53909406-310
662	FA53903033	655	FA53904533	657	FA53906033	654	FA53907533	657	FA53909433
662	FA53903033-300	655	FA53904533-300	657	FA53906033-300	654	FA53907533-300	657	FA53909433-300
662	FA53903033-310	655	FA53904533-310	657	FA53906033-310	654	FA53907533-310	657	FA53909433-310
662	FA53903206	656	FA53904706	657	FA53906206	654	FA53907606	658	FA53909606
662	FA53903206-300	656	FA53904706-300	657	FA53906206-300	654	FA53907606-300	658	FA53909606-300
662	FA53903206-310	656	FA53904706-310	657	FA53906206-310	654	FA53907606-310	658	FA53909606-310
662	FA53903233	656	FA53904733	657	FA53906233	654	FA53907633	658	FA53909633
662	FA53903233-300	656	FA53904733-300	657	FA53906233-300	654	FA53907633-300	658	FA53909633-300
662	FA53903233-310	656	FA53904733-310	657	FA53906233-310	654	FA53907633-310	658	FA53909633-310
662	FA53903306	656	FA53904806	657	FA53906306	655	FA53907806	658	FA53909806
662	FA53903306-300	656	FA53904806-300	657	FA53906306-300	655	FA53907806-300	658	FA53909806-300
662	FA53903306-310	656	FA53904806-310	657	FA53906306-310	655	FA53907806-310	658	FA53909806-310
662	FA53903333	656	FA53904833	657	FA53906333	655	FA53907833	658	FA53909833
662	FA53903333-300	656	FA53904833-300	657	FA53906333-300	655	FA53907833-300	658	FA53909833-300
662	FA53903333-310	656	FA53904833-310	657	FA53906333-310	655	FA53907833-310	658	FA53909833-310
662	FA53903506	656	FA53905006	658	FA53906506	655	FA53908006	658	FA53910006
662	FA53903506-300	656	FA53905006-300	658	FA53906506-300	655	FA53908006-300	658	FA53910006-300
662	FA53903506-310	656	FA53905006-310	658	FA53906506-310	655	FA53908006-310	658	FA53910006-310
662	FA53903533	656	FA53905033	658	FA53906533	655	FA53908033	658	FA53910033
662	FA53903533-300	656	FA53905033-300	658	FA53906533-300	655	FA53908033-300	658	FA53910033-300
662	FA53903533-310	656	FA53905033-310	658	FA53906533-310	655	FA53908033-310	658	FA53910033-310
662	FA53903606	656	FA53905106	658	FA53906606	655	FA53908206	659	FA53910206
662	FA53903606-300	656	FA53905106-300	658	FA53906606-300	655	FA53908206-300	659	FA53910206-300
662	FA53903606-310	656	FA53905106-310	658	FA53906606-310	655	FA53908206-310	659	FA53910206-310

Page	Reference	Page	Reference	Page	Reference	Page	Reference	Page	Reference
659	FA53910233	662	FA53912233	662	FA53914633	654	FA53916633	554	FA54000218
659	FA53910233-300	662	FA53912233-300	662	FA53914633-300	654	FA53916633-300	554	FA54000230
659	FA53910233-310	662	FA53912233-310	662	FA53914633-310	654	FA53916633-310	554	FA54000233
659	FA53910406	662	FA53912406	654	FA53914806	655	FA53916806	555	FA54000301
659	FA53910406-300	662	FA53912406-300	654	FA53914806-300	655	FA53916806-300	555	FA54000306
659	FA53910406-310	662	FA53912406-310	654	FA53914806-310	655	FA53916806-310	555	FA54000312
659	FA53910433	662	FA53912433	654	FA53914833	655	FA53916833	555	FA54000318
659	FA53910433-300	662	FA53912433-300	654	FA53914833-300	655	FA53916833-300	555	FA54000330
659	FA53910433-310	662	FA53912433-310	654	FA53914833-310	655	FA53916833-310	555	FA54000333
659	FA53910606	654	FA53913006	655	FA53915006	656	FA53917006	562	FA54100201
659	FA53910606-300	654	FA53913006-300	655	FA53915006-300	656	FA53917006-300	562	FA54100206
659	FA53910606-310	654	FA53913006-310	655	FA53915006-310	656	FA53917006-310	562	FA54100212
659	FA53910633	654	FA53913033	655	FA53915033	656	FA53917033	562	FA54100218
659	FA53910633-300	654	FA53913033-300	655	FA53915033-300	656	FA53917033-300	562	FA54100230
659	FA53910633-310	654	FA53913033-310	655	FA53915033-310	656	FA53917033-310	562	FA54100233
660	FA53910806	655	FA53913206	656	FA53915206	657	FA53917206	562	FA54100301
660	FA53910806-300	655	FA53913206-300	656	FA53915206-300	657	FA53917206-300	562	FA54100306
660	FA53910806-310	655	FA53913206-310	656	FA53915206-310	657	FA53917206-310	562	FA54100312
660	FA53910833	655	FA53913233	656	FA53915233	657	FA53917233	562	FA54100318
660	FA53910833-300	655	FA53913233-300	656	FA53915233-300	657	FA53917233-300	562	FA54100330
660	FA53910833-310	655	FA53913233-310	656	FA53915233-310	657	FA53917233-310	562	FA54100333
660	FA53911006	656	FA53913406	657	FA53915406	658	FA53917406	562	FA54100501
660	FA53911006-300	656	FA53913406-300	657	FA53915406-300	658	FA53917406-300	562	FA54100506
660	FA53911006-310	656	FA53913406-310	657	FA53915406-310	658	FA53917406-310	562	FA54100512
660	FA53911033	656	FA53913433	657	FA53915433	658	FA53917433	562	FA54100518
660	FA53911033-300	656	FA53913433-300	657	FA53915433-300	658	FA53917433-300	562	FA54100530
660	FA53911033-310	656	FA53913433-310	657	FA53915433-310	658	FA53917433-310	562	FA54100533
660	FA53911206	657	FA53913606	658	FA53915606	659	FA53917606	562	FA54100601
660	FA53911206-300	657	FA53913606-300	658	FA53915606-300	659	FA53917606-300	562	FA54100606
660	FA53911206-310	657	FA53913606-310	658	FA53915606-310	659	FA53917606-310	562	FA54100612
660	FA53911233	657	FA53913633	658	FA53915633	659	FA53917633	562	FA54100618
660	FA53911233-300	657	FA53913633-300	658	FA53915633-300	659	FA53917633-300	562	FA54100630
660	FA53911233-310	657	FA53913633-310	658	FA53915633-310	659	FA53917633-310	562	FA54100633
661	FA53911406	658	FA53913806	659	FA53915806	660	FA53917806	563	FA54100701
661	FA53911406-300	658	FA53913806-300	659	FA53915806-300	660	FA53917806-300	563	FA54100706
661	FA53911406-310	658	FA53913806-310	659</					

Page	Reference	Page	Reference	Page	Reference	Page	Reference	Page	Reference
564	FA54101118	565	FA54110018	526	FA844281101	482	FA9418613106-310	482	FA94831206
564	FA54101130	565	FA54110030	526	FA844281106	482	FA9418613133	482	FA94831206-300
564	FA54101133	565	FA54110033	526	FA844281112	482	FA9418613133-300	482	FA94831206-310
564	FA54101201	565	FA54110201	526	FA844281118	482	FA9418613133-310	482	FA94831233
564	FA54101206	565	FA54110206	526	FA844281130	482	FA941861333	482	FA94831233-300
564	FA54101212	565	FA54110212	526	FA844281133	482	FA941861333-300	482	FA94831233-310
564	FA54101218	565	FA54110218	526	FA844281201	482	FA941861333-310	482	FA94831306
564	FA54101230	565	FA54110230	526	FA844281206	483	FA941871306	482	FA94831306-300
564	FA54101233	565	FA54110233	526	FA844281212	483	FA941871333	482	FA94831306-310
564	FA54101301	494	FA54200201	526	FA844281218	484	FA941881206	482	FA948313106
564	FA54101306	494	FA54200206	526	FA844281230	484	FA941881206-300	482	FA948313106-300
564	FA54101312	494	FA54200212	526	FA844281233	484	FA941881206-310	482	FA948313106-310
564	FA54101318	494	FA54200218	526	FA844281301	484	FA941881233	482	FA948313133
564	FA54101330	494	FA54200230	526	FA844281306	484	FA941881233-300	482	FA948313133-300
564	FA54101333	494	FA54200233	526	FA844281312	484	FA941881233-310	482	FA948313133-310
564	FA54101401	494	FA54200301	526	FA844281318	484	FA941881306	482	FA94831333
564	FA54101406	494	FA54200306	526	FA844281330	484	FA941881306-300	482	FA94831333-300
564	FA54101412	494	FA54200312	526	FA844281333	484	FA941881306-310	482	FA94831333-310
564	FA54101418	494	FA54200318	526	FA844282101	484	FA9418813106	482	FA94851206
564	FA54101430	494	FA54200330	526	FA844282106	484	FA9418813106-300	482	FA94851206-300
564	FA54101433	494	FA54200333	526	FA844282112	484	FA9418813106-310	482	FA94851206-310
562	FA54102301	494	FA54200501	526	FA844282118	484	FA9418813133	482	FA94851233
562	FA54102306	494	FA54200506	526	FA844282130	484	FA9418813133-300	482	FA94851233-300
562	FA54102312	494	FA54200512	526	FA844282133	484	FA9418813133-310	482	FA94851233-310
562	FA54102318	494	FA54200518	526	FA844282201	484	FA941881333	482	FA94851306
562	FA54102330	494	FA54200530	526	FA844282206	484	FA941881333-300	482	FA94851306-300
562	FA54102333	494	FA54200533	526	FA844282212	484	FA941881333-310	482	FA94851306-310
562	FA54102601	494	FA54200601	526	FA844282218	485	FA941891306	482	FA948513106
562	FA54102606	494	FA54200606	526	FA844282230	485	FA941891333	482	FA948513106-300
562	FA54102612	494	FA54200612	526	FA844282233	618	FA942842401	482	FA948513106-310
562	FA54102618	494	FA54200618	526	FA844282301	618	FA942842406	482	FA948513133
562	FA54102630	494	FA54200630	526	FA844282306	618	FA942842412	482	FA948513133-300
562	FA54102633	494	FA54200633	526	FA844282312	618	FA942842418	482	FA948513133-310
563	FA54102801	494	FA54200701	526	FA844282318	618	FA942842430	482	FA94851333
563	FA54102806	494	FA54200706	526	FA844282330	618	FA942842433	482	FA94851333-300
563	FA54102812	494	FA54200712	526	FA844282333	618	FA942851401	482	FA94851333-310
563	FA54102818	494	FA54200718	612	FA8801	618	FA942851406	484	FA94861206
563	FA54102830	494	FA54200730	612	FA8806	618	FA942851412	484	FA94861206-300
563	FA54102833	494	FA54200733	612	FA8812	618	FA942851418	484	FA94861206-310
563	FA54103001	494	FA54200901	612	FA8818	618	FA942851430	484	FA94861233
563	FA54103006	494	FA54200906	612	FA8830	618	FA942851433	484	FA94861233-300
563	FA54103012	494	FA54200912	612	FA8833	616	FA9433	484	FA94861233-310
563	FA54103018	494	FA54200918	617	FA8906	484	FA94801206	484	FA94861306
563	FA54103030	494	FA54200930	617	FA8933	484	FA94801206-300	484	FA94861306-300
563	FA54103033	494	FA54200933	617	FA9006	484	FA94801206-310	484	FA94861306-310
564	FA54103201	584	FA68	617	FA9033	484	FA94801233	484	FA948613106
564	FA54103206	486	FA71	616	FA9306	484	FA94801233-300	484	FA948613106-300
564	FA54103212	486	FA72	616	FA9333	484	FA94801233-310	484	FA948613106-310
564	FA54103218	617	FA7806	616	FA9406	484	FA94801306	484	FA948613133
564	FA54103230	617	FA7833	482	FA941861206	484	FA94801306-300	484	FA948613133-300
564	FA54103233	617	FA7906	482	FA941861206-300	484	FA94801306-310	484	FA948613133-310
564	FA54103401	617	FA7933	482	FA941861206-310	484	FA948013106	484	FA94861333
564	FA54103406	486	FA81	482	FA941861233	484	FA948013106-300	484	FA94861333-300
564	FA54103412	486	FA82	482	FA941861233-300	484	FA948013106-310	484	FA94861333-310
564	FA54103418	526	FA84280001	482	FA941861233-310	484	FA948013133	616	FA9506
564	FA54103430	526	FA84280006	482	FA941861306	484	FA948013133-300	616	FA9533
564	FA54103433	526	FA84280012	482	FA941861306-300	484	FA948013133-310	616	FA9606
565	FA54110001	526	FA84280018	482	FA941861306-310	484	FA94801333	614	FA962821301
565	FA54110006	526	FA84280030	482	FA9418613106	484	FA94801333-300	614	FA962821306
565	FA54110012	526	FA84280033	482	FA9418613106-300	484	FA94801333-310	614	FA962821312

Page	Reference	Page	Reference	Page	Reference	Page	Reference	Page	Reference
614	FA962821318	619	FA972471412-310	619	FA972481330-310				
614	FA962821330	619	FA972471418	619	FA972481333				
614	FA962821333	619	FA972471418-300	619	FA972481333-300				
614	FA962821401	619	FA972471418-310	619	FA972481333-310				
614	FA962821406	619	FA972471430	619	FA972481401				
614	FA962821412	619	FA972471430-300	619	FA972481401-300				
614	FA962821418	619	FA972471430-310	619	FA972481401-310				
614	FA962821430	619	FA972471433	619	FA972481406				
614	FA962821433	619	FA972471433-300	619	FA972481406-300				
614	FA962831301	619	FA972471433-310	619	FA972481406-310				
614	FA962831306	619	FA972472301	619	FA972481412				
614	FA962831312	619	FA972472301-300	619	FA972481412-300				
614	FA962831318	619	FA972472301-310	619	FA972481412-310				
614	FA962831330	619	FA972472306	619	FA972481418				
614	FA962831333	619	FA972472306-300	619	FA972481418-300				
614	FA962831401	619	FA972472306-310	619	FA972481418-310				
614	FA962831406	619	FA972472312	619	FA972481430				
614	FA962831412	619	FA972472312-300	619	FA972481430-300				
614	FA962831418	619	FA972472312-310	619	FA972481430-310				
614	FA962831430	619	FA972472318	619	FA972481433				
614	FA962831433	619	FA972472318-300	619	FA972481433-300				
614	FA962832301	619	FA972472318-310	619	FA972481433-310				
614	FA962832306	619	FA972472330	618	FA972841301				
614	FA962832312	619	FA972472330-300	618	FA972841306				
614	FA962832318	619	FA972472330-310	618	FA972841312				
614	FA962832330	619	FA972472333	618	FA972841318				
614	FA962832333	619	FA972472333-300	618	FA972841330				
614	FA962832401	619	FA972472333-310	618	FA972841333				
614	FA962832406	619	FA972472401	618	FA972841401				
614	FA962832412	619	FA972472401-300	618	FA972841406				
614	FA962832418	619	FA972472401-310	618	FA972841412				
614	FA962832430	619	FA972472406	618	FA972841418				
614	FA962832433	619	FA972472406-300	618	FA972841430				
616	FA9633	619	FA972472406-310	618	FA972841433				
619	FA972471301	619	FA972472412	618	FA972842301				
619	FA972471301-300	619	FA972472412-300	618	FA972842306				
619	FA972471301-310	619	FA972472412-310	618	FA972842312				
619	FA972471306	619	FA972472418	618	FA972842318				
619	FA972471306-300	619	FA972472418-300	618	FA972842330				
619	FA972471306-310	619	FA972472418-310	618	FA972842333				
619	FA972471312	619	FA972472430	618	FA972851301				
619	FA972471312-300	619	FA972472430-300	618	FA972851306				
619	FA972471312-310	619	FA972472430-310	618	FA972851312				
619	FA972471318	619	FA972472433	618	FA972851318				
619	FA972471318-300	619	FA972472433-300	618	FA972851330				
619	FA972471318-310	619	FA972472433-310	618	FA972851333				
619	FA972471330	619	FA972481301	403	FA98				
619	FA972471330-300	619	FA972481301-300	403	FA99				
619	FA972471330-310	619	FA972481301-310	435	RF25746				
619	FA972471333	619	FA972481306	157	RF25747				
619	FA972471333-300	619	FA972481306-300	157	RF25748				
619	FA972471333-310	619	FA972481306-310	191	RF25				

FLOS
OUTDOOR

Pointbreak

16

- Pointbreak Bollard
- Pointbreak Balisage
- Pointbreak Wall
- Pointbreak Ceiling



In Vitro

46

- In Vitro Bollard
- In Vitro Wall
- In Vitro Ceiling
- In Vitro Suspended
- In Vitro Unplugged

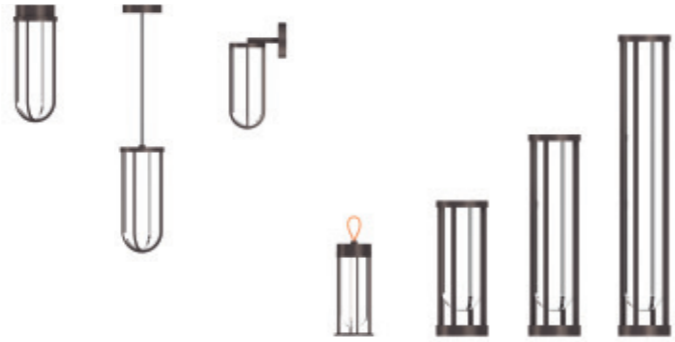

Mile

56

- Mile Wall
- Mile Bollard
- Mile Path
- Mile Ceiling
- Mile Recessed



Captain Flint

90

- Captain Flint Wall
- Captain Flint Floor



IC Light

98

- IC Wall
- IC Floor



Caule

106

- Caule Floor / Floor Nest
- Caule Bollard / Bollard Nest

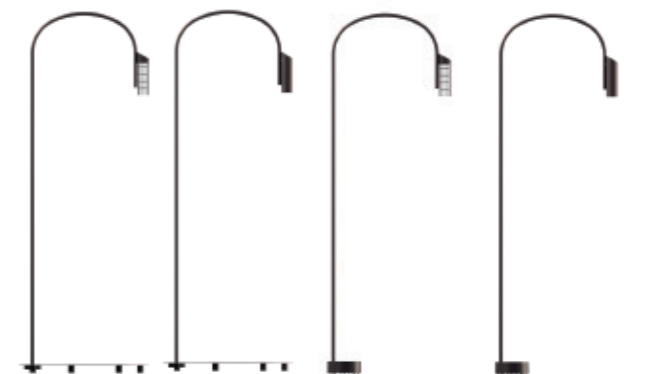

Flauta

122

Flauta Riga
Flauta Spiga



Lighting In The Rain

132

Romeo C3
KTribe F3
Superarchimoon



Landlord

140

Landlord Spot
Landlord Soft
Landlord Ground



Bellhop

158

Bellhop Wall
Bellhop Bollard
Bellhop Pole



Casting

170

Casting Concrete
Casting C
Casting T



Walkstick / Wallstick

182

Walkstick Pipe
Walkstick
Wallstick



Belvedere

196

- Belvedere Clove
- Belvedere Spot
- Belvedere Wall



Klein Pro

208



Zefiro

218



I - Ron

228



Talia

236

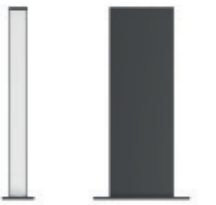

45

246



Real Matter

254



My Way

264



Camouflage

272



Climber

282



Heavy Metal

294

Heavy Metal Spot
Heavy Metal Wall



Marco

316



Fenestra

326



A-Round

334



A-Rise

344



Gobi

368



C-Me

390

C-Me Round
C-Me Square
C-Me Rectangle
C-Me Line

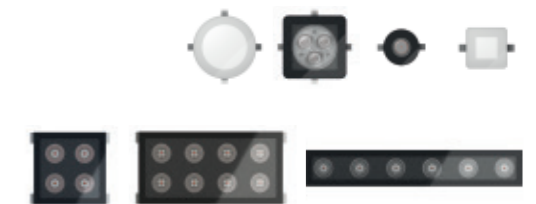

Outgraze

414



Tau

464



Cielo 476



Eclipse 488

Eclipse
Eclipse Mini



Hyperion 498

Hyperion
Hyperion Mini



Platter 508



Emma 520

Emma Wall
Emma Ceiling



Leila 536



Kirk 548



Spock 556



Aimer 568

Aimer
Aimer Aqua



Franco

602

Franco
Franco Pole



Perseo

624

Perseo
Perseo Pole



Dooku

648



Contact Italy

Flos Spa
Via Angelo Faini, 2
25073 Bovezzo (Brescia)
Tel +39 0302438.1
Fax +39 0302438.250
info@flos.com

ARES s.r.l. - Socio Unico
Viale dell'Artigianato, 24
20881 Bernareggio
Monza Brianza, Italy
Tel +39 039 6900892
Fax +39 039 6901855
flos.outdoor@flos.com

Contact Spain

Antares Iluminación S.A.U.
Calle Mallorca, 1
Poligono Industrial Reva 46394
Ribarroja (Valencia)
Tel +34 96 166 95 20
Fax +34 96 166 82 86
flos.architectural@flos.com

Distribution Spain

Antares Iluminación s.A.U.
Calle Mallorca, 1
Poligono Industrial Reva
46394 Ribarroja (Valencia)
Tel +34 96 166 95 20
Fax +34 96 166 82 86
flos.architectural@flos.com

Distribution Belgium And Luxembourg

Flos Belux
M +32 474 739 080
flosbelux@flos.com

Distribution Norway

Drammensveien 120
0277 Oslo - Norway
Tel +47 (0) 2212 86 00
Fax +47 (0) 2212 86 08
info.norge@flos.com

Distribution Sweden

FLOS Sweden
Lützensgatan 1
11520 Stockholm - Sweden
Tel +4686604405
info.se@flos.com

Distribution Denmark

FLOS Scandinavia A/S
Kuglegaardsvej 13-17
1434 Copenhagen K - Denmark
Tel +4533886000
info.dk@flos.com

Distribution Amsterdam

Cruquiusweg 109S
1019 AG Amsterdam
The Netherlands
Tel +31 (0) 20 560 50 60
flosnetherlands@flos.com

Distribution France

Flos France
20-22, Passage Dauphine
75006 Paris
Tel +33 (0) 1 40 64 17 44
flos.france@flos.com

Distribution Germany

Flos GmbH
Obermünsterstraße 18
93047 Regensburg,
Germany
Tel +49 941 630837 00
Fax +49 941 630837 60
info@flos-gmbh.de

Distribution United Kingdom

Atrium Ltd.
28 Leonard Street
EC2A 4BY London
Tel +44 (0) 20 7681 9933
Fax +44 (0) 20 7681 9943
flos@atrium.ltd.uk

International Projects

Boccia Giandonato
tel +44(0)20 7681 9933
giandonato.boccia@flos.com

Distribution Japan

Flos Co., Ltd.
PMC Building 9F
1-23-5 Higashiazabu
Minato-Ku Tokyo 104-0044
Tel +81 (0) 3 3582 1468
Fax +81 (0) 3 3582 097
flosjapan@flosjapan.com

Distribution Asia Pacific

50 Raffles Place, #30-00
Singapore Land Tower
Singapore 048623
Tel +65 90056328
Tel +65 91267780
flosasia@flos.com

Distribution China

Flos Illumination
(Shanghai) Co. Ltd.
Unit 101, Floor 1, Building B9
No. 800 of Chang De road
Jing An District, Shanghai,
200040, China
Tel +86 021 62176187

(South China)

Tel +86 1392 9975 703
alan.wong@flos.com

Distribution Latin America

Flos LatAm
M +52 55 6960 1772
flos.latinamerica@flos.com

Distribution India

Flos Representative Office
1, Commonwealth Lane
#08-12, 149544 Singapore
Tel +91 9999306667
Fax +65 (0) 6372 7607
flosindia@flos.com

Distribution U.S.A.

Flos USA Inc.
40-20 22nd Street - 3rd Floor
Long Island City, NY 11101
Tel +1 (800) 8414011
info@flosusa.com

Distribution Middle East

Flos Middle East
Dubai Design District
Building 1B, Office 303
P.O.Box number 333025
Dubai, United Arab Emirates
Tel: +971 4 566 0123
Mob: +971 543567356

Distribution Hong Kong

M +852 9307 3713
flosasia@flos.com

Showroom Stockholm

FLOS Sweden
Lützensgatan 1
11520 Stockholm
Sweden
Tel +4686604405
info.se@flos.com

Showroom Copenhagen

FLOS Scandinavia A/S
Kuglegaardsvej 13-17
1434 Copenhagen K
Denmark
Tel +4533886000
info.dk@flos.com

Showroom Amsterdam

Cruquiusweg 109Q
1019 AG Amsterdam
The Netherlands
Tel +31 (0) 20 560 50 60
showroom.amsterdam@flos.com

Showroom Oslo

Drammensveien 120
0277 Oslo - Norway
Tel +47 (0) 2212 86 00
Fax +47 (0) 2212 86 08
info.norge@flos.com

Showroom Milano

Corso Monforte, 15
20122 Milano
Tel +39 02 79 84 57
Fax +39 02 89 78 56 41
showroom.milan@flos.com

Showroom Paris

20-22, Passage Dauphine
75006 Paris
Tel +33 (0) 1 40 64 17 44
flos.france@flos.com

Showroom Tokyo

PMC Building 9F
1-23-5 Higashiazabu
Minato-Ku
Tokyo 104-0044
Tel +81 (0) 3 35 82 14 68
Fax +81 (0) 3 3582 0974
showroom.tokyo@flos.com

Flagship Store Milano

Corso Monforte, 9
20122- Milano
Tel +39 02 37011080
Fax +39 02 780833
flosmilano@flos.com

Flagship Store Roma

Via del Babuino, 85
00187 - Roma
Tel +39 06 3207631
Fax +39 06 3207690
flosroma@flos.com

Flagship Store New York

135 Madison Ave
New York, NY 10016
Tel +1 212 941 4760
Fax +1 212 941 4763
info@flosusa.com

Flagship Store Paris

15, Rue de Bourgogne
75007- Paris
Tel +33 (0) 1 53 85 49 93
Fax +33 (0) 1 53 85 49 99
flosparis@flos.com

Flagship Store LYON

17 Rue Jarente
69002 - Lyon
Tel +33 478621301
Fax +33 478622119
floslyon@flos.com

Flagship Store Stockholm

FLOS Sverige
Lützensgatan 1
11520 Stockholm
Sweden
Tel +46086604405
info.se@flos.com

Art Direction and Graphic Design
Apartamento Studios

Art Photography
Nicholas Alan Cope

In-Place Photography
Tommaso Sartori

Still Life Photography
Piero Fasanotto

Layout
Flos Architectural Team

Printed
Graficart srl - Treviso (IT)

Edition
January 2022
Copyright © Flos 2022
All Rights Reserved

Acknowledgements
Arch. Ricardo Bofill
Mrs Natalia Chiner
Mrs Celia Lescouet
Apulia Exclusive Houses

Il nostro mondo si evolve continuamente.
I progressi tecnici sono all'ordine del
giorno nel nostro settore.

Lo scopo di Flos è offrire sempre la
tecnologia più affidabile a disposizione,
rivedendo continuamente i prodotti e
aggiornandoli non appena le evoluzioni
tecnologiche offrono vantaggi per
i nostri partner e clienti.

Questa filosofia fa sì che il nostro
catalogo e le schede tecniche
dei nostri prodotti siano anch'essi
in continua evoluzione, con
la conseguente necessità di
aggiornamenti e revisioni continue.

Per tanto, quando avete bisogno di
dettagli tecnici e delle informazioni più
recenti, sfogliate la sezione prodotti
del nostro sito Web ufficiale Flos.com:
è aggiornato quotidianamente e
offre gli ultimi dettagli dei prodotti, dei
codici degli articoli disponibili e
tutta la documentazione per il download
immediato.

www.flos.com

Credits

As our world is in constant evolution,
technical upgrades happens every day
in our business.

Flos aim is to offer always the best
reliable technology available,
constantly reviewing our products
and upgrading them as soon as
technologic evolutions offers benefits
for our partners and clients.

This philosophy means that our
technical catalogue and product data
sheets also are in constant evolution,
requiring upgrades and constants
reviewing.

Thus, when you need technical
details and the most recent
product information, please browse
the product section of our Flos.
com official website: it is updated
daily, and there you'll find the
latest product details, all available
part numbers, all product documents
available for immediate download.

www.flos.com

742

999006591



74

©red

