

Luce è colore

Axolight



**Axolight**

# Axolight





Siamo avvolti da stimoli sempre nuovi, ispirati da splendidi toni di colore che dettano stile e tendenza in armonia con la cultura della bellezza. Design, forma, emozione sono il racconto del nostro stile, tra progetti all'avanguardia da scoprire e idee di successo da ammirare e la caparbia volontà di lasciare un segno di forte personalità, un segno di colore Axolight.

*We capture the always new stimuli surrounding us, taking inspiration by the amazing color shades that enable us to harmonize style and trends with the culture of beauty.*

*Our style is defined by design, form and emotion: a powerful mix of avant-garde to be discovered, passionately crafted ideas and the ambition to leave a strong personal mark, an Axolight color mark.*

# Indice alfabetico

Alphabetical index

---

**Aibu** 16

TABLE

---

**Alysoid** 18

SUSPENSION

---

**Aura (Avir)** 22

WALL | CEILING | SUSPENSION

---

**AX 20** 26

WALL | WALL AND CEILING | SUSPENSION | FLOOR

---

**Bell** 28

CEILING | SUSPENSION

---

**Clavius** 32

WALL | CEILING | SUSPENSION | FLOOR | TABLE

---

**Cloudy** 36

SUSPENSION

---

**Cut** 40

SUSPENSION | FLOOR | TABLE

---

**Ego** 46

WALL AND CEILING

---

**Fairy** 48

WALL | RECESSED | CEILING | SUSPENSION

---

**Favilla** 52

WALL AND CEILING | RECESSED

---

**Fedora** 54

RECESSED | SUSPENSION

---

**Framework** 56

WALL AND CEILING | SUSPENSION

---

**Hoops** 60

CEILING | SUSPENSION

---

**Jewel** 64

SUSPENSION

---

**Kwic** 70

WALL AND CEILING | SUSPENSION | FLOOR

---

**Layers** 76

SUSPENSION

---

**Liaison** 78

SUSPENSION

---

**Lik** 84

WALL

---

**Manto** 86

SUSPENSION

---

**Melting Pot** 92

WALL | SUSPENSION | FLOOR

---

**Mountain View** 96

SUSPENSION

---

**Muse** 100  
WALL AND CEILING | TABLE

---

**Nafir** 102  
SUSPENSION

---

**Nelly** 104  
WALL AND CEILING

---

**Nelly Straight** 105  
WALL AND CEILING

---

**Orchid** 106  
WALL AND CEILING | SUSPENSION | FLOOR | TABLE |  
CEILING

---

**Plumage** 112  
SUSPENSION | FLOOR

---

**Polia** 114  
WALL

---

**Rythmos** 116  
WALL | SUSPENSION

---

**Shatter** 118  
CEILING | SUSPENSION

---

**Skin** 120  
CEILING | SUSPENSION

---

**Skirt** 124  
CEILING | SUSPENSION | TABLE

---

**Spillray** 128  
WALL | RECESSED | SUSPENSION

---

**Stilla** 134  
SUSPENSION

---

**Stormy** 136  
WALL & CEILING

---

**U-Light** 138  
WALL | WALL AND CEILING | SUSPENSION

---

**Ukiyo** 146  
WALL AND CEILING

---

**Urban & Urban Mini** 148  
CEILING | SUSPENSION

---

**Uriel** 154  
WALL

---

**Vasily** 156  
WALL

---

**Velvet** 158  
CEILING | SUSPENSION

---

**Virtus** 162  
SUSPENSION

# Sospensione

Suspension

Alysoid p 18



Aura (Avir) p 22



AX 20 p 27



Bell p 28

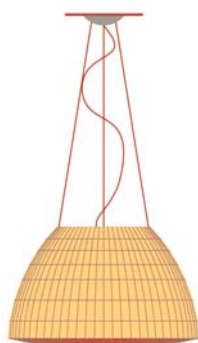

Clavius p 32

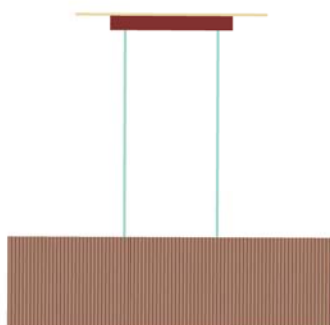

Cloudy p 36

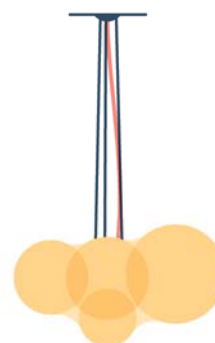

Cut p 40



Fairy p 48



Fedora p 54



Framework p 58

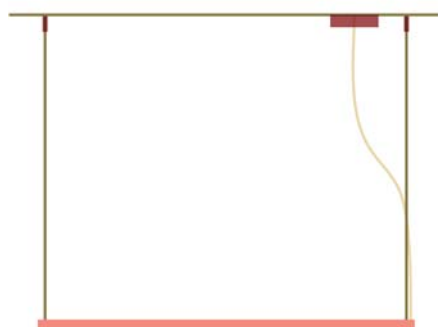

Hoops p 60

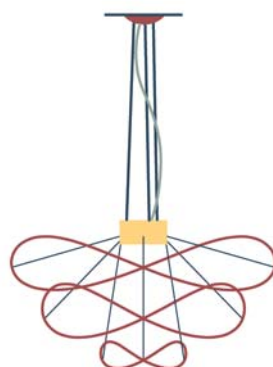

Jewel p 64

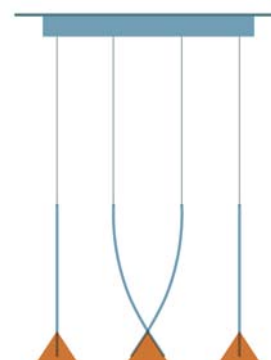



Kwic p 70

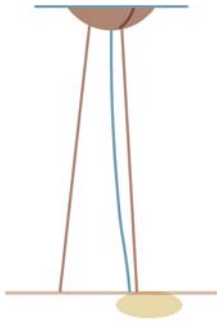

Layers p 76

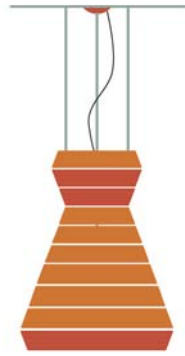

Liaison p 78



Manto p 86

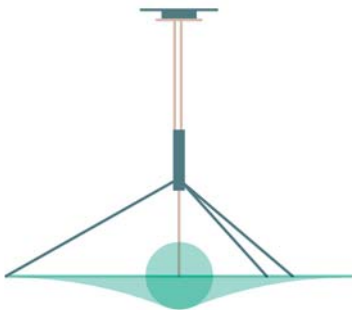

Melting Pot p 92



Mountain View p 96

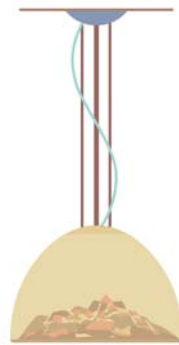

Nafir p 102



Orchid p 107

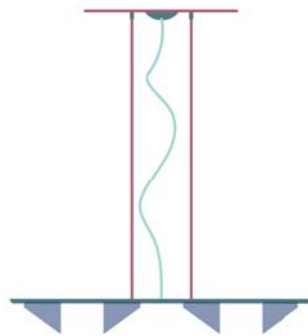

Plumage p 112

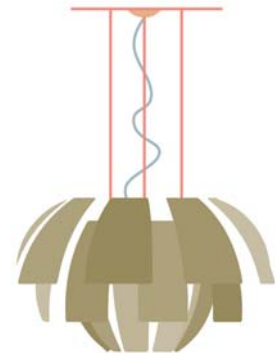

Rythmos p 117

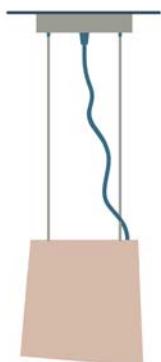

Shatter p 119

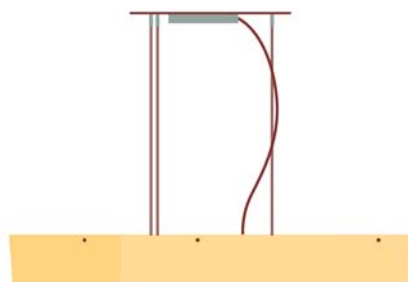

Skin p 120

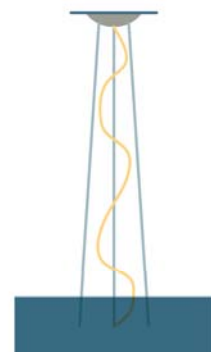

# Sospensione

Suspension

Skirt p 124

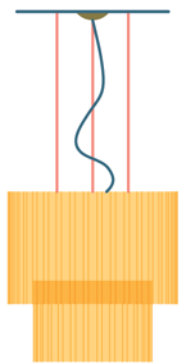

Spillray p 128



Stilla p 134



U-light p 138

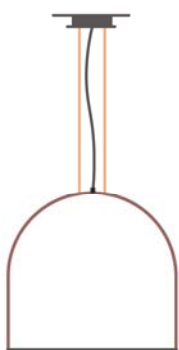

U-light ring 142

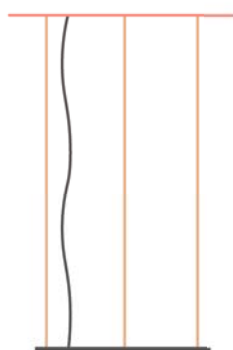

Urban & Urban Mini p 148



Velvet p 158

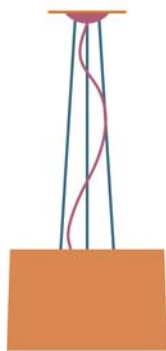

Virtus p 162



# Parete

Wall

Aura (Avir) p 23



AX 20 p 26 / 183

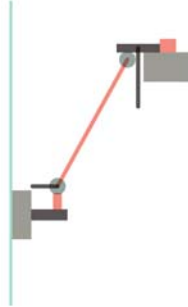

Clavius p 34

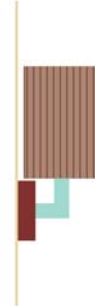

Fairy p 50



Lik p 84



Melting Pot p 94



Polia p 114



Rythmos p 116



Spillray p 131



U-light p 138 / 281



Uriel p 154



Vasily p 156



# Soffitto

Ceiling

Aura (Avir) p 22 / 179

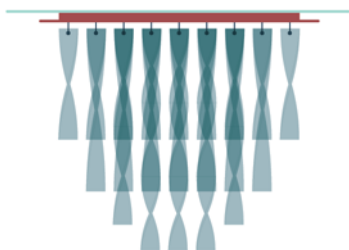

Bell p 31



Clavius p 32 / 193



Fairy p 48 / 200

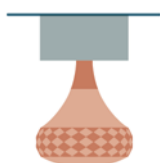

Hoops p 62

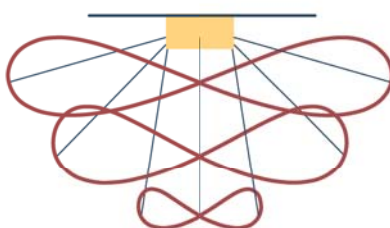

Orchid p 106 / 246



Shatter p 118



Skin p 123



Skirt p 126

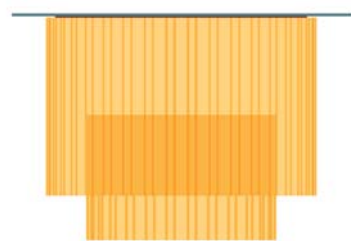

Urban & Urban Mini  
p 152



Velvet p 159



# Incasso

Recessed

Fairy p 48 / 199-200



Favilla p 52

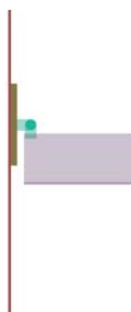

Fedora p 54 / 204



Spillray p 132

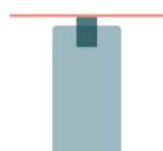

# Parete e soffitto

Wall and ceiling

AX 20 p 27

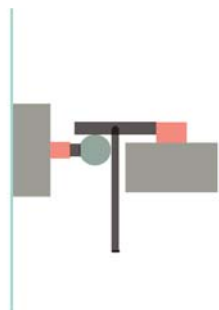

Ego p 46

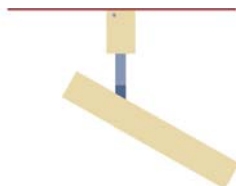

Favilla p 53



Framework p 56

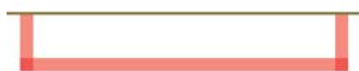

Kwic p 72



Muse p 100



Nelly & Nelly Straight  
p 104-105



Orchid p 108

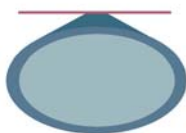

Stormy p 136



U-light p 143

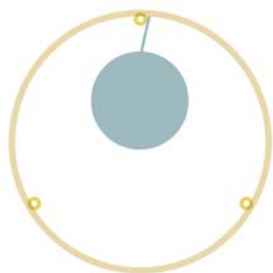

Ukiyo p 146



# Tavolo

Table

Aibu p 16



Clavius p 35

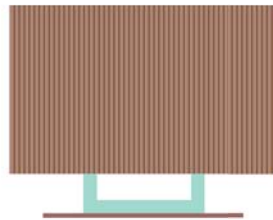

Cut p 42



Muse p 100 / 240



Orchid p 110



Skirt p 124 / 269

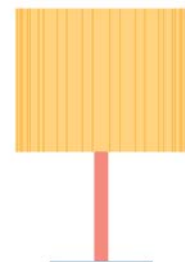

# Terra

Floor

Ax20 p 26

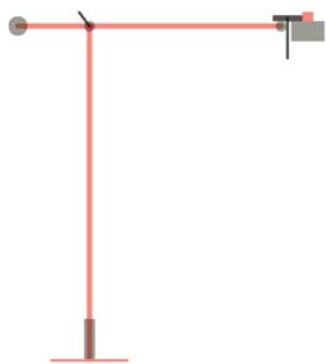

Clavius p 33



Cut p 43



Kwic p 74



Melting Pot p 93



Orchid p 106



Plumage p 113

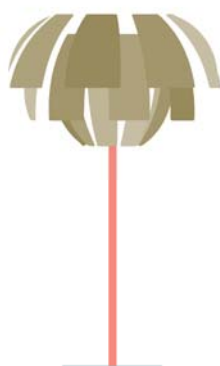



# Misure

## Sizes

Small

S

Medium

M

Large

L

Extra large

XL

Axolight progetta e realizza prodotti (in pronta consegna e custom) per grandi, medi e piccoli spazi. Per ogni prodotto qui rappresentato, è possibile conoscere l'offerta dimensionale seguendo l'indicazione delle taglie S, M, L, XL.

*Axolight designs and manufactures products (prompt delivery and custom made) for large, medium and small spaces.*

*For each product family represented here it is possible to know the dimensional offer following the size indication S, M, L, XL.*

# Aibu

Giovanni Barbato



La potenza generatrice di un soffio  
crea la sua pura bellezza artigianale.  
Due semisfere in dolce movimento sono  
un archetipo capace di stupire per la  
semplicità della sua forza.

*The generating power of a breath creates  
its pure artisanal beauty.*

*Two half-spheres in gentle movement  
constitute an archetype able to surprise  
for the simplicity of its strength.*



# Alysoid

Ryosuke Fukusada







Preziosi dettagli sferici si inseguono con morbida eleganza e compongono segni aperti nello spazio.

Il raffinato volume di Alysoïd si lascia attraversare dallo sguardo per ammirare la bellezza, ovunque sia.

*Precious spherical details chase each other with soft elegance and compose open signs in space.*

*The refined volume of Alysoïd lets itself be looked in order to admire the beauty, wherever it is.*



# Aura (Avir)

Manuel Vivian





M

L

XL





*Onde di luce, riflessi dinamici, unicità.  
La sapienza e la cura artigianale di un mastro  
vetraio scorre nella forma di piccoli vetri  
che insieme formano un'immagine fluida,  
acquatica, dal bagliore diffuso.*

*Waves of light, dynamic reflections,  
uniqueness. The knowledge and  
craftsmanship of a master glassmaker  
express themselves in the shape of small  
glasses that together compose a fluid and  
aquatic image with a diffused glow.*



# AX 20

Manuel Vivian

Forme essenziali e rigorose definiscono il flusso di luce con intensità e precisione. Con la semplicità di dettagli puliti e finiture razionali, AX20 illumina l'eleganza del design.

*Essential and rigorous forms define the flow of light with intensity and precision. Thanks to the simplicity of clear details and functional finishes, AX20 illuminates the elegance of design.*





# Bell

Manuel Vivian







Tessuto pongé multicolore e anima pluridimensionale per ogni stile e ogni spazio. Bell avvolge la materia e racconta la luce con la sua personalità dinamica, vivace e modulare.

*Multicoloured pongé fabric and multidimensional soul for every style and space. Bell wraps the matter and tells about the light with its dynamic, lively, and modular personality.*



M

L

XL





S

M

L

# Clavius

Manuel Vivian



Ammirare la trama di un prezioso filo di seta lavorato pazientemente a mano. Clavius esprime la sua eleganza raffinata irradiando morbidezza e atmosfera tra luce ed ombra.

*Admire the texture of a precious hand-made silken thread lampshade. Clavius expresses its refined elegance by radiating softness and atmosphere between light and shadow.*





# Cloudy

Dima Loginoff







Tra design e arte. Cloudy evoca una prodigiosa scultura luminosa contemporanea che domina lo spazio con il suo forte potere installativo ed una fluttuante presenza scenica di grandissimo impatto.

*Between design and art. Cloudy evokes a prodigious contemporary and luminous sculpture.*

*It dominates the space with its strong installation power and a fluctuating stage presence of great impact.*





M



# Cut

Timo Ripatti





Morbidezza dell'atmosfera e personalizzazione dell'orientamento. Cut esprime una luce emozionale e un design raffinato, che per scelta progettuale non sa abbagliare, ma avvolge con dolcezza.

*Softness of the atmosphere and personalization of orientation. Cut expresses a refined design and an emotional light which does not dazzle, but wraps gently.*







# Ego

Axolight Lab



Realizzato interamente in ottone naturale, è una sintesi di eleganza e personalità. La perfezione delle lenti utilizzate genera un flusso luminoso tanto attraente quanto inaspettato.

*Realized entirely from natural brass, it is synthesis of elegance and personality. The perfection of the lenses used generates a highly impressive and unexpected beam of light.*



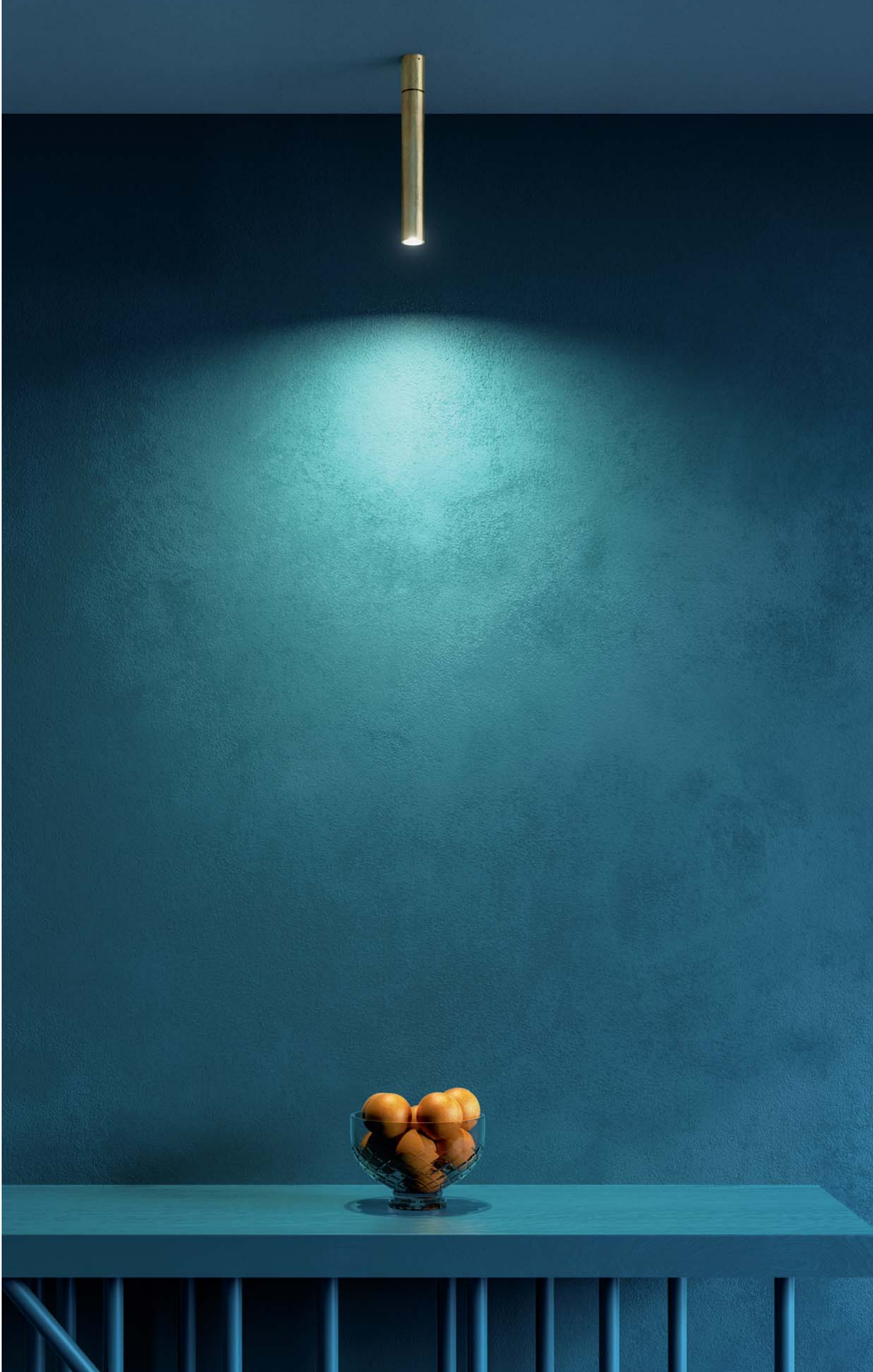

S

M

L

# Fairy

Manuel Vivian







Riflessi multipli e simmetrie cangianti attraversano la materia per generare nuove forme. Così il nitore dell'alluminio incontra le sfaccettature del cristallo in un gioco caleidoscopico di bagliori imprevedibili.

*Multiple reflections and iridescent symmetries go through the matter to generate new forms. The clarity of aluminum meets the facets of the crystal in a kaleidoscopic game of unpredictable brilliance.*

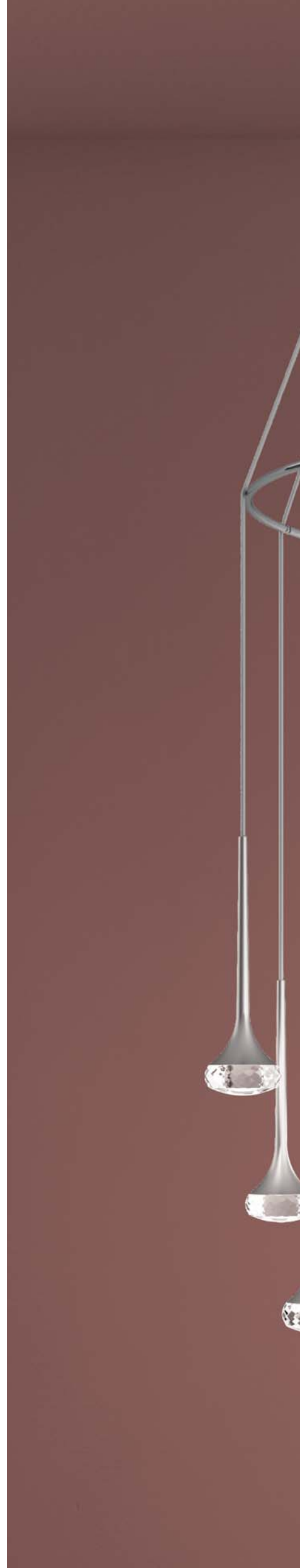





# Favilla

Manuel Vivian



Favilla ha il pieno e totale dominio della luce e si plasma con la bellezza della semplicità in ogni spazio e direzione.

*Favilla has the full and total dominion of light. It is molded by the beauty of simplicity in every space and direction.*

S | M | L

# Fedora

Dimo Loginoff

Sinuosa e aggraziata come una matrioska, Fedora esprime la sua personalità da singola o moltiplicata in configurazioni di grande scenografia. Contemporaneità e tradizione si sposano nella sua luminosa armonia.

*Sinuous and graceful as a matryoshka doll/ Russian doll, Fedora, single or multiple, expresses its personality in configurations of great scenography. Contemporary and tradition are combined in its luminous harmony.*







# Framework

Manuel Vivian

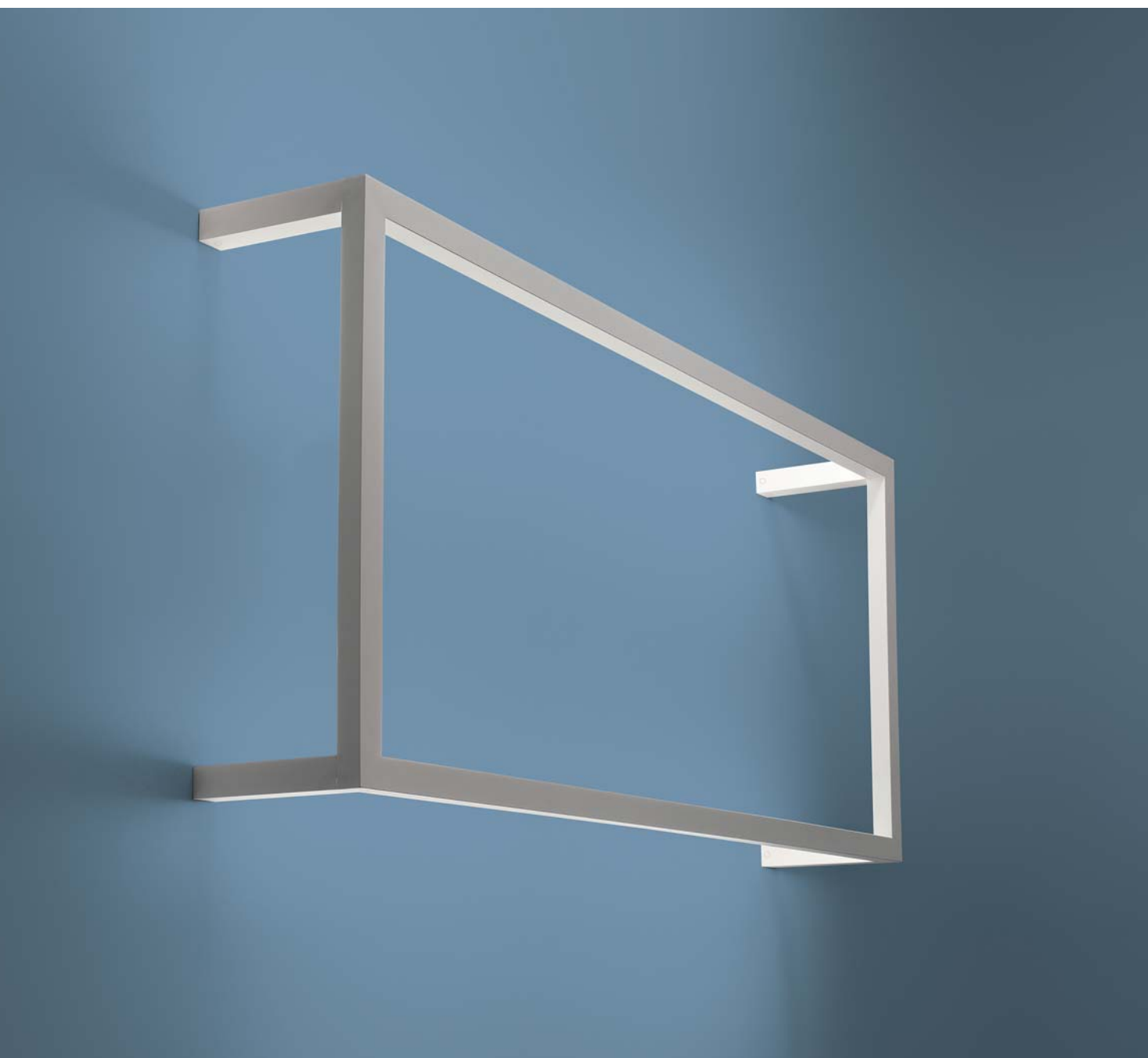

Geometrie luminose creano forme inaspettate dal design puro. Framework disegna una scenografia razionale con la luce indiretta e riflessa e le sue linee pulite.

*Luminous geometries create unexpected shapes with a pure design. Framework draws a rational scenography with its indirect and reflected light and its clean lines.*

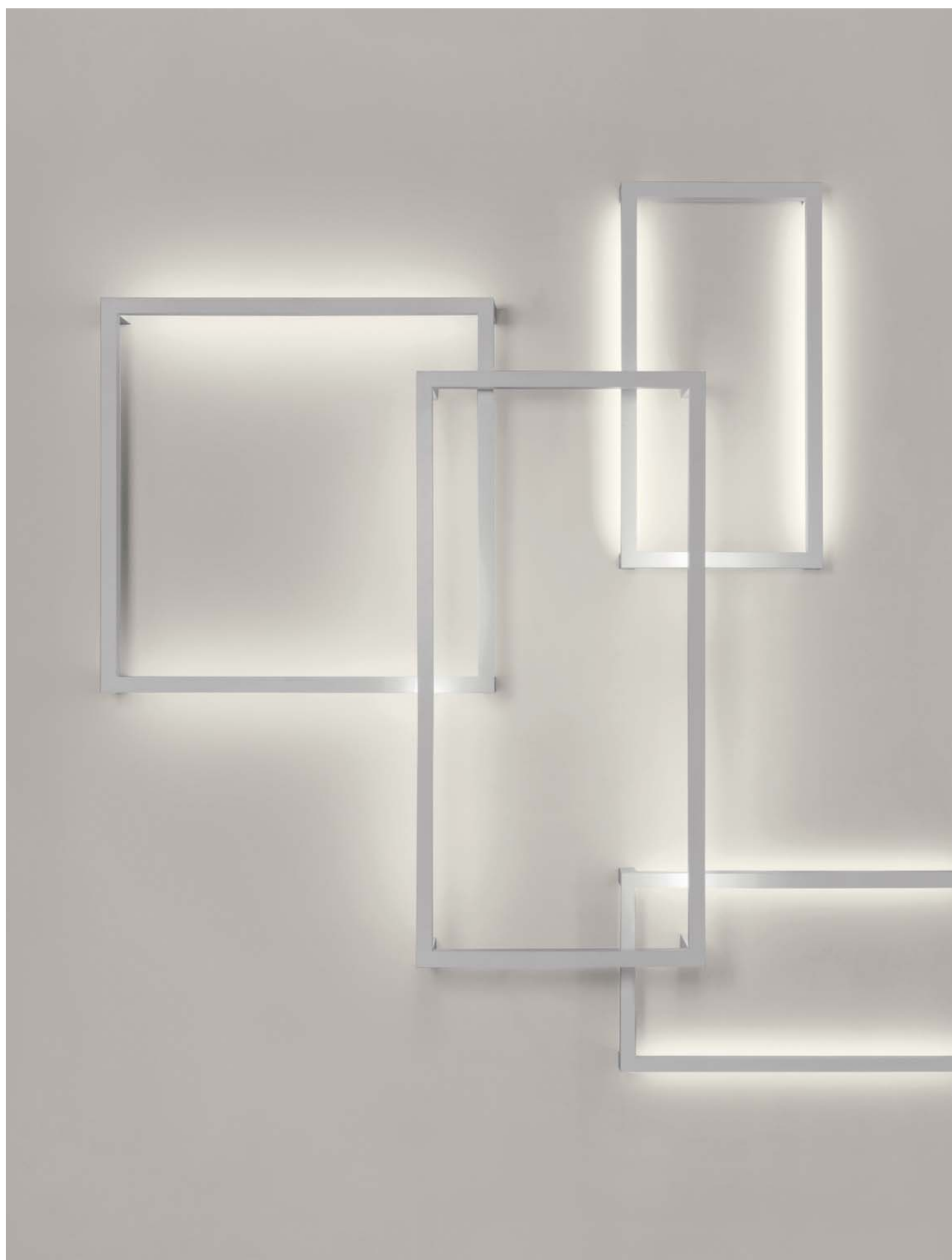



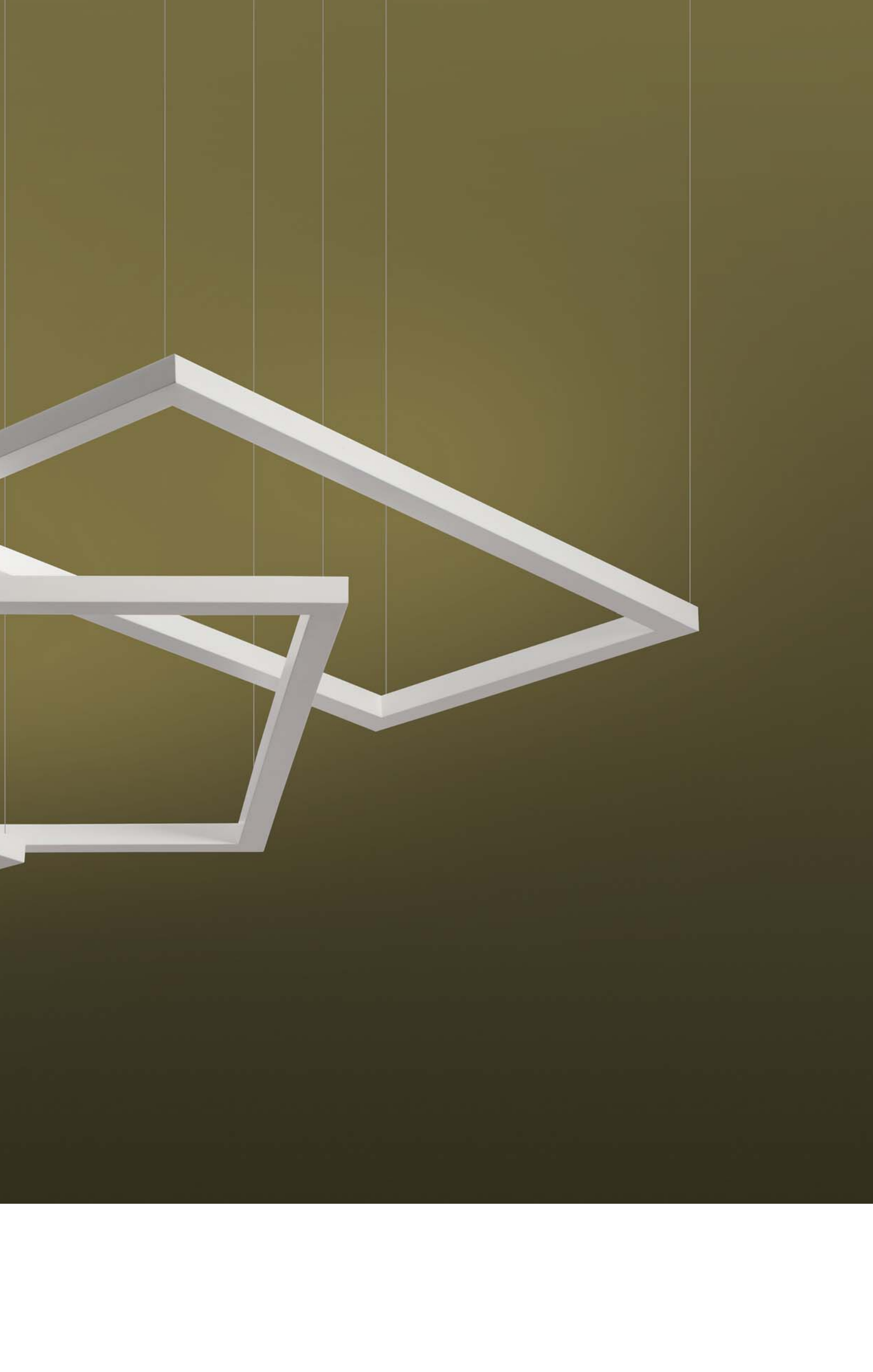

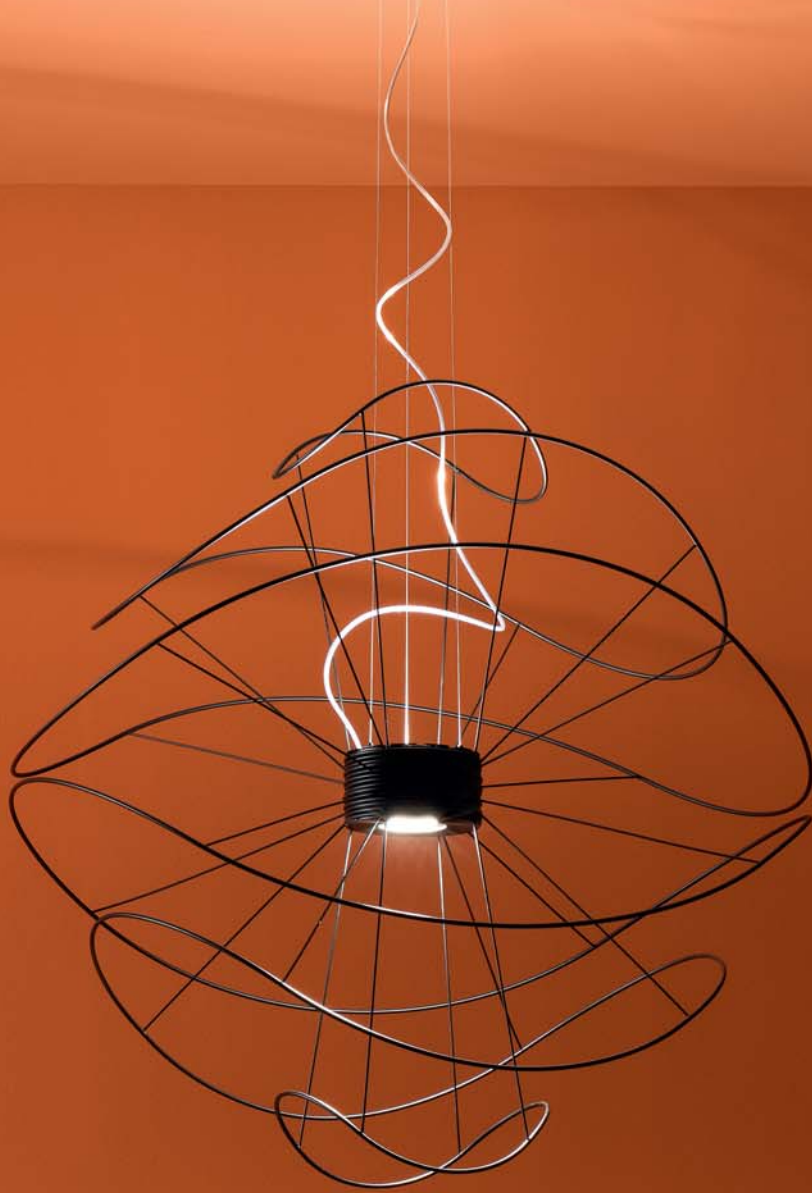

# Hoops

Giovanni Barbato

Linee che danzano voluttuose attorno ad un nucleo in un gioco mutevole di forme riflesse e luce. La sinuosità di Hoops è un sottile filo volteggiante, da seguire con lo sguardo.

*Lines that dance voluptuously around a nucleus in a changing game of reflected shapes and light. The sinuosity of Hoops is a thin twirling thread, to be followed by the eyes.*









# Jewel

Studio Yonoh





Come un piccolo prezioso gioiello sospeso tra raffinatezza e armonia. Jewel splende intensamente, senza abbagliare, in spazi di ogni dimensione, sintesi componibile di gusto e amore per l'ambiente.

*Like a small precious jewel suspended between refinement and harmony. Jewel shines intensely, without dazzling, in spaces of any size. It is a modular synthesis of taste and love for the environment.*



S | M | L



PRODUCED WITH  
RECYCLED MATERIAL



M

L

XL









# Kwic

S. & R. Cornelissen









Kwic è vivace espressione di geometria grafica, dinamismo e ricercatezza. Le sue linee asimmetriche sono come goccioline inafferrabili che giocano con riflessi di elevata intensità luminosa.

*Kwic is a lively expression of graphic geometry, dynamism and refinement. Its asymmetrical lines are like elusive droplets that play with highly intense, luminous reflections.*

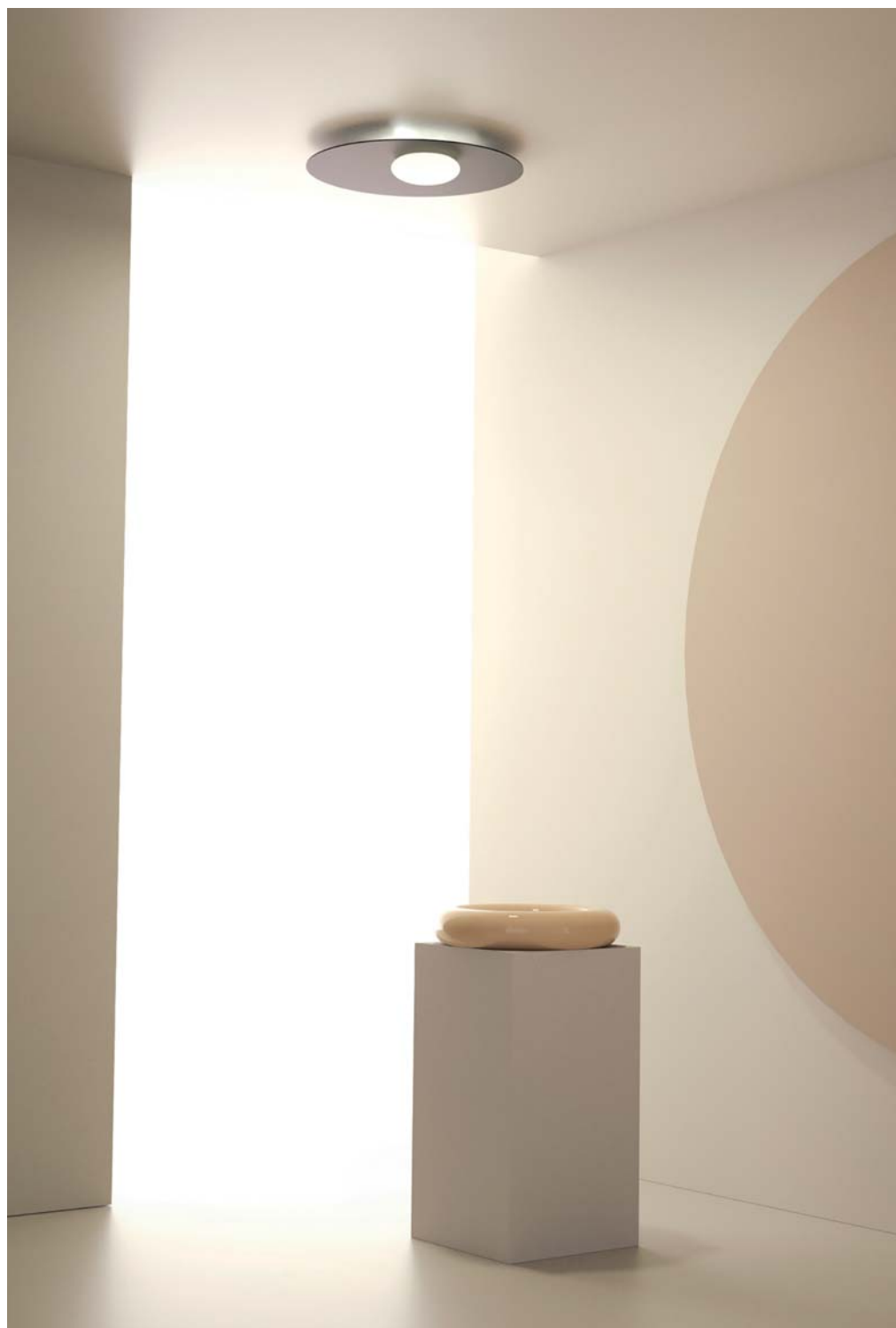

L

XL

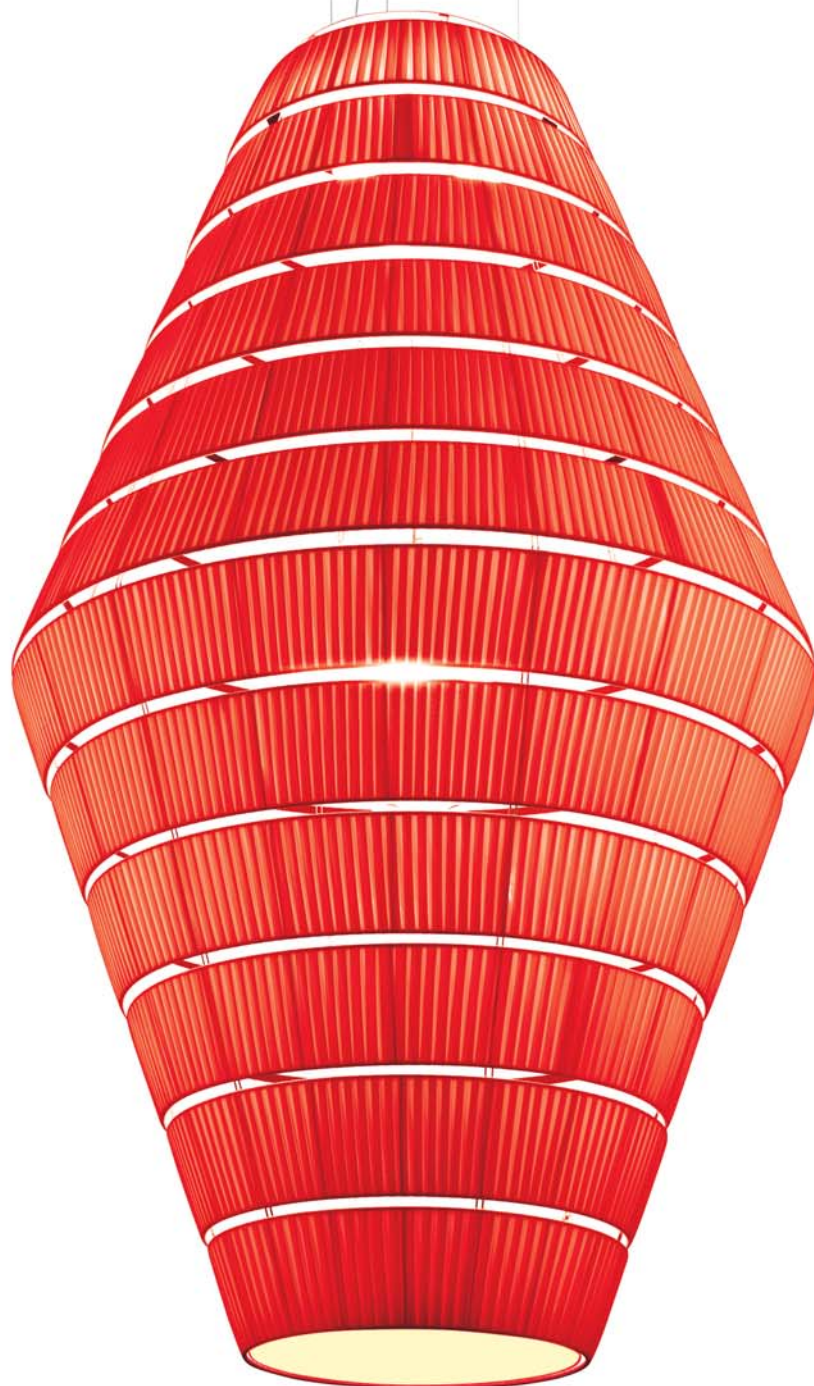

# Layers

Vanessa Vivian

Monumentali scenografie di luce, combinazioni senza limiti di forma, dimensione e colore. Con Layers l'immaginazione non ha confini.

*Monumental scenographies of light, combinations without limits of shape, size and colour. With Layers imagination has no boundaries.*



# Liaison

Sara Moroni







Leggerezza ed eleganza modulari. Liaison racconta il perfetto equilibrio di tre archetipi geometrici: sfera, cerchio e cilindro compongono un sistema che abbraccia dal pendente singolo a composizioni multiple.

*Modular lightness and elegance. Liaison tells about the perfect balance of three geometric archetypes: sphere, circle and cylinder compose a system that includes the single pendant and as well as the multiple compositions.*

S

M

L

XL

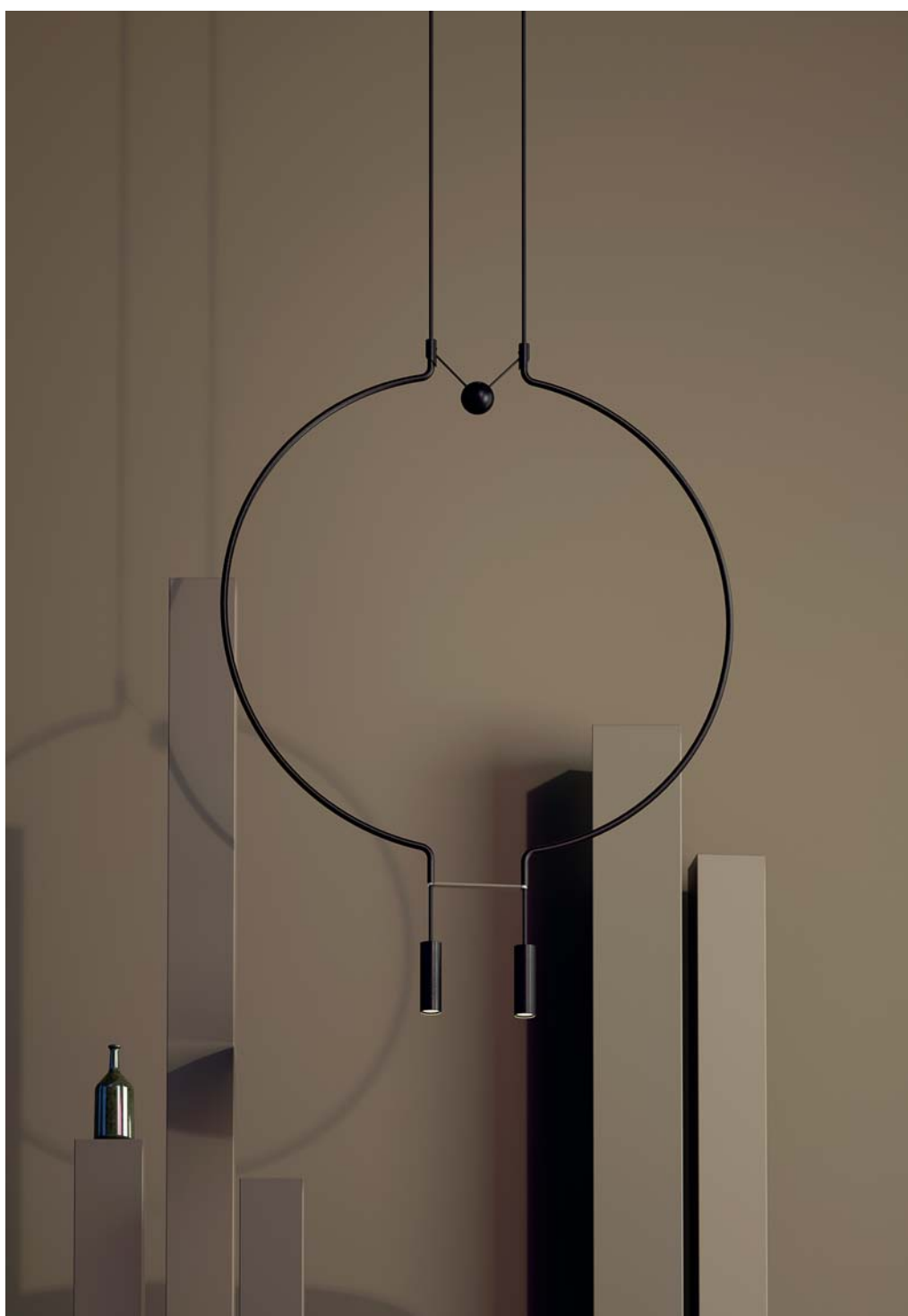





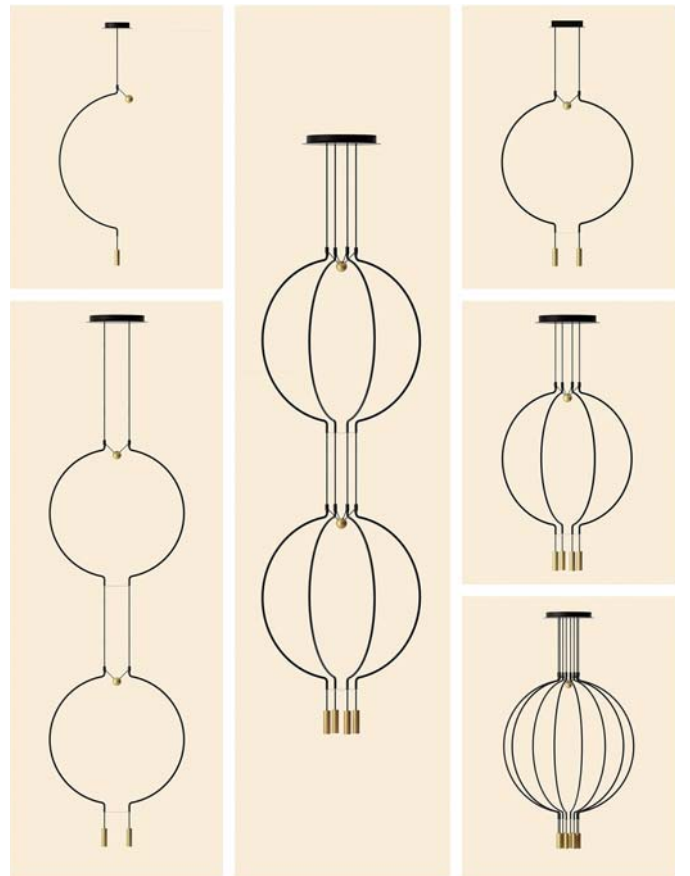



# Lik

S. & R. Cornelissen



S

Dal design morbido di Lik, l'intensa luce rifugiata nel retro si diffonde con armoniosi riflessi nella parete. Semplicità essenziale e tecnologia formale in perfetto connubio.

*Lik has a soft design and its intense light hidden in the back spreads with harmonious reflections on the wall. Essential simplicity and formal technology are combined in a perfect harmony.*



# Manto

Daide Besozzi





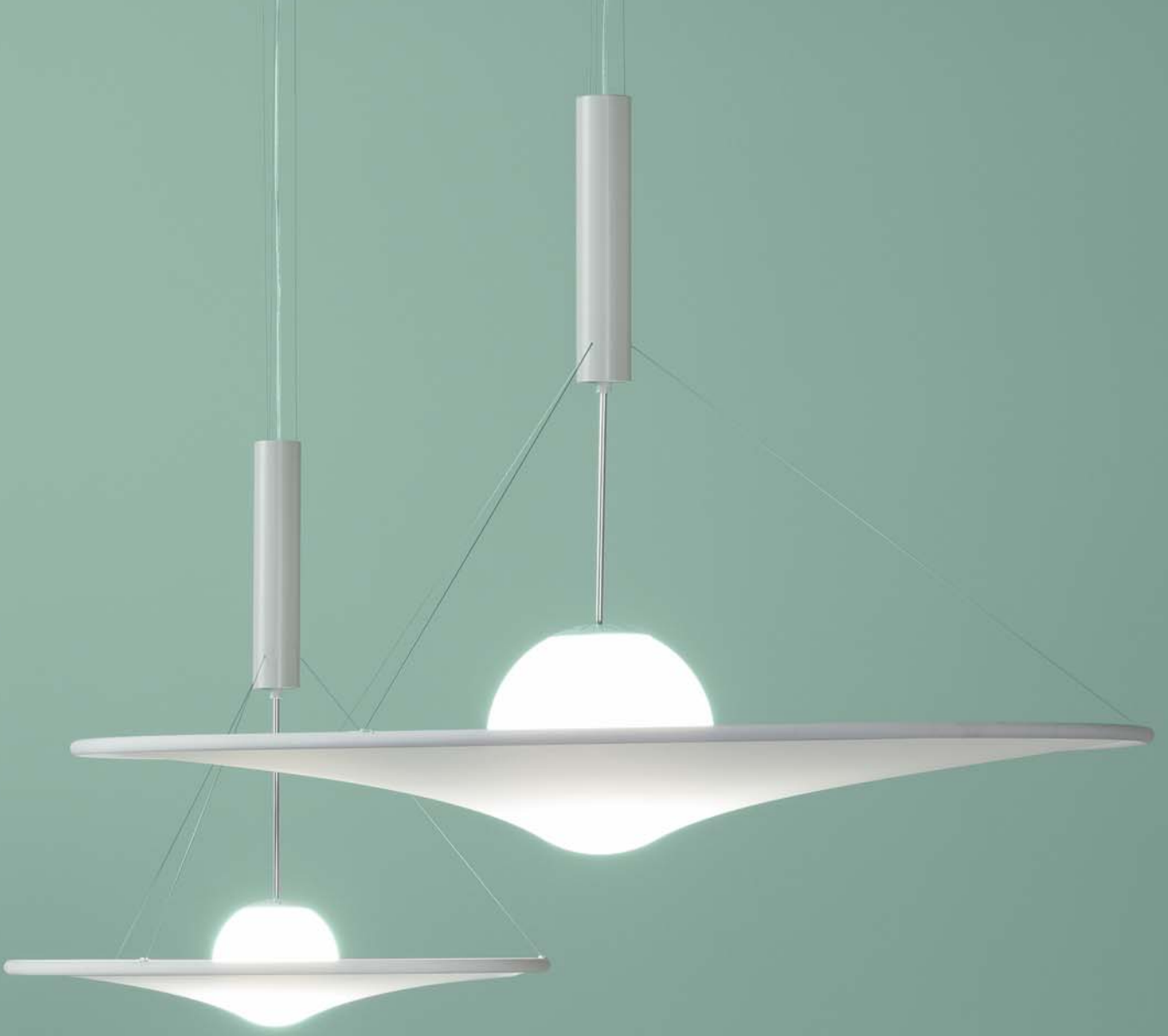

M

L

XL



Manto esprime la sua vera personalità nel movimento reciproco di semplici geometrie. Con sapere artigianale e natura dinamica sa mutare nella forma e variare l'effetto luminoso portato nello spazio, tra stupore e tecnologia.

*Manto expresses its true personality in the reciprocal movement of simple geometries. Thanks to its artisan knowledge and dynamic nature, it changes shape and varies the luminous effect in the space, between wonder and technology.*

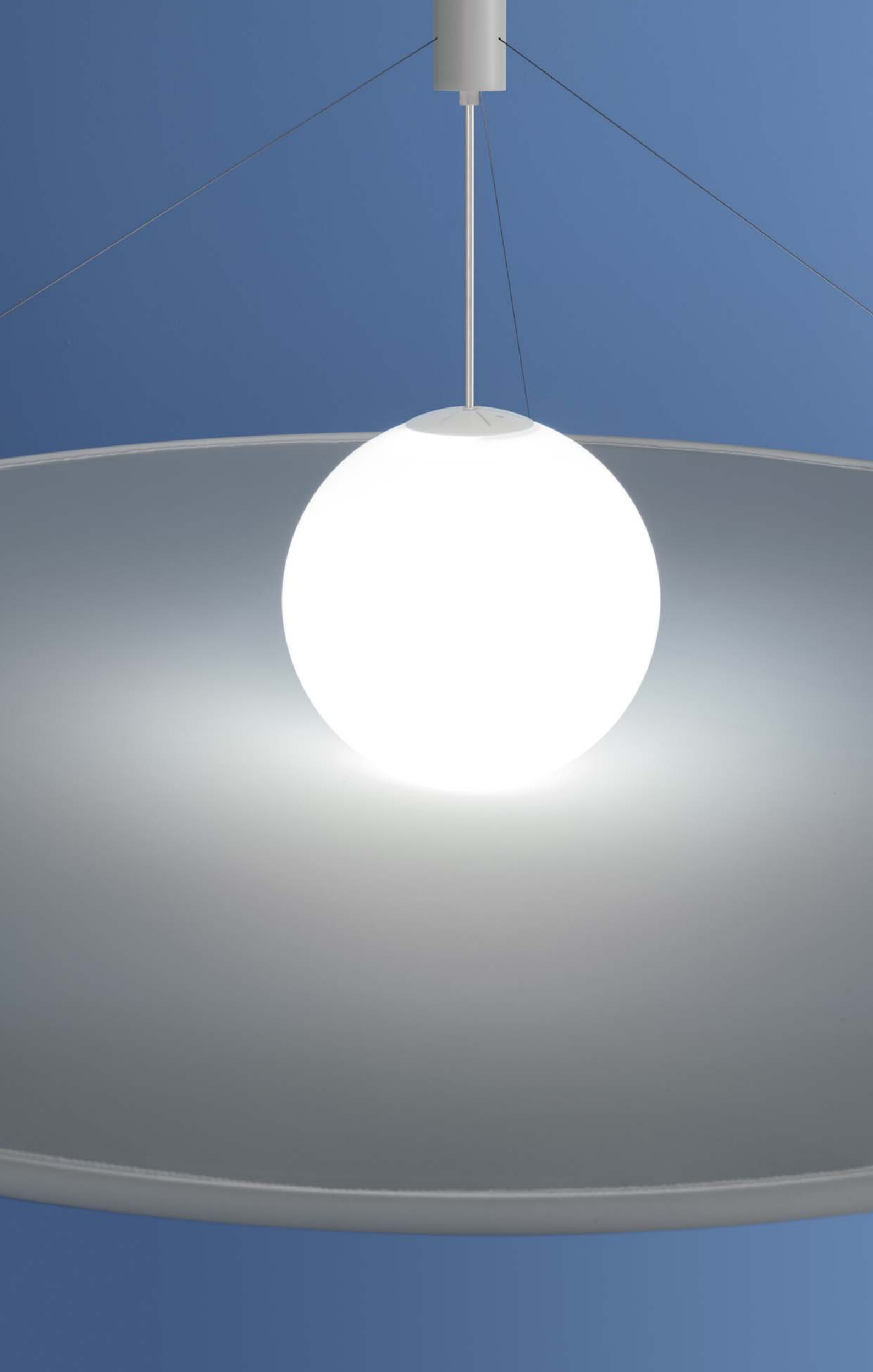







M

L

XL

# Melting Pot

Sandro Santantonio



Fusione di elementi differenti che creano  
un'identità unica e irripetibile.  
Melting pot unisce carattere e personalità  
generando forme dall'architettura  
sorprendente, miscellanea di stile.

*Fusion of different elements that create  
an unique and unrepeatable identity.  
Melting pot combines character and  
personality, creating forms characterized  
by a surprising architecture, a mix of style.*







# Mountain View

Dima Loginoff









Mountain View racconta la meraviglia di una montagna racchiusa in una campana trasparente. Con maestria realizzativa e sapienza artigianale, il vetro soffiato si modella in una personalità preziosa e raffinata.

*Mountain View tells about the wonder of a mountain enclosed in a transparent bell. Made of transparent blown glass hand-crafted by a master artisan, Mountain View has a precious and refined personality.*

# Muse

Sandro Santantonio

L'allegria incontra l'ispirazione e insieme creano Muse. Colori vivaci, linee flessuose, tessuto fluido si uniscono lasciando libero spazio espressivo alla fantasia.

*Cheerfulness meets inspiration and together they create Muse. Energetic colours, sinuous lines, fluid fabric come together, leaving the imagination completely free to express itself.*





# Nafir

Karim Rashid

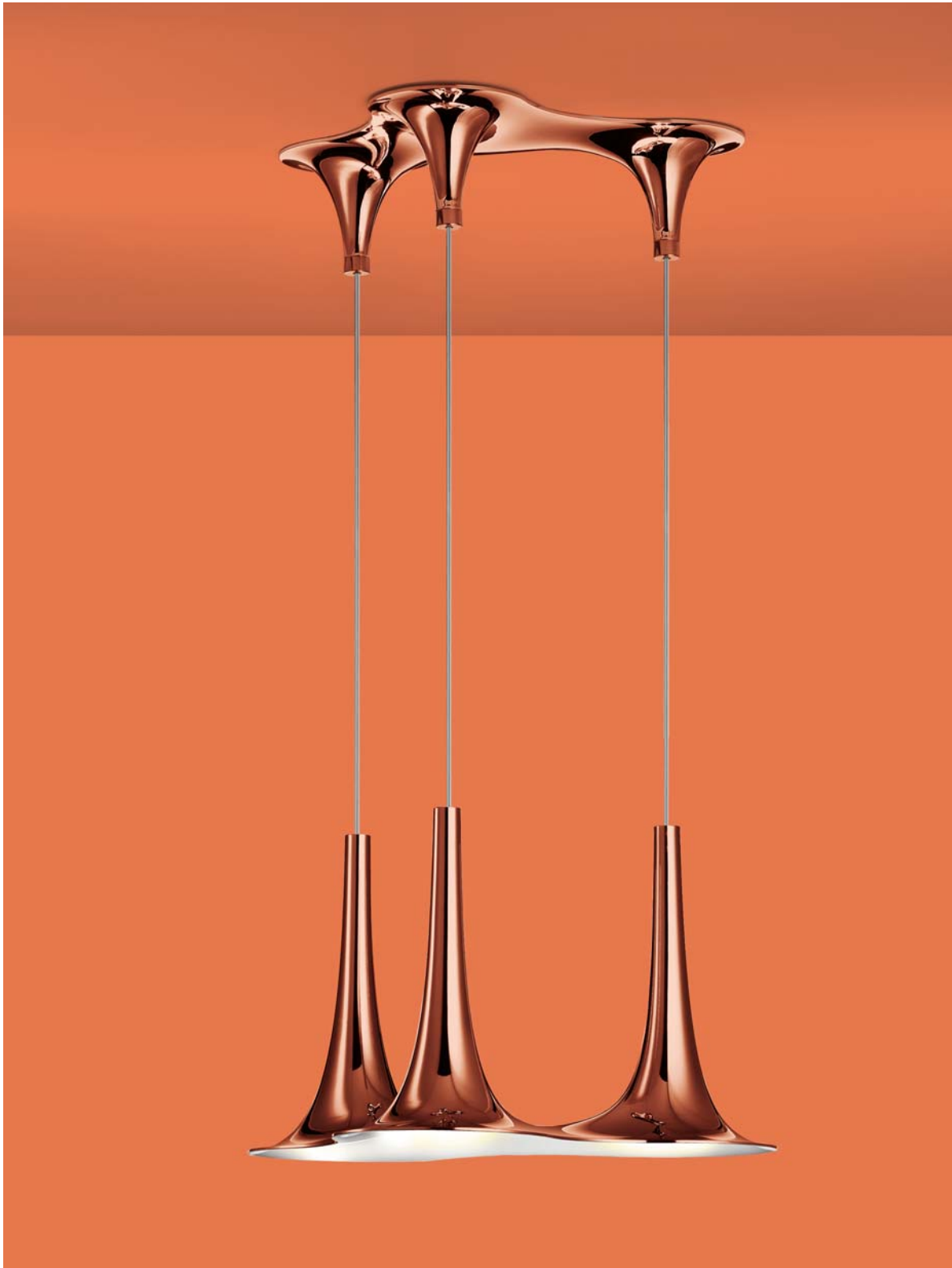





Design fluido dal carattere glamour chic.  
Nafir con le sue linee morbide e liquide  
modella nello spazio stile e dinamicità  
con raffinata eleganza e suggestioni  
contemporanee.

*Fluid design with a glamorous and chic  
personality. Nafir with its soft and liquid  
lines shapes style and dynamism in space  
with refined elegance and contemporary  
suggestions.*

# Nelly

Manuel Vivian

Semplicità geometrica e gioco discreto di chiaroscuri. Nelly è la purezza di una tela bianca interrotta da una traccia lineare che dolcemente la attraversa, enfatizzando riflessi e dettagli.

*Geometric simplicity and a discreet game of light and shade. Nelly is the purity of a white canvas interrupted by a linear trace that gently crosses it, emphasizing reflections and details.*

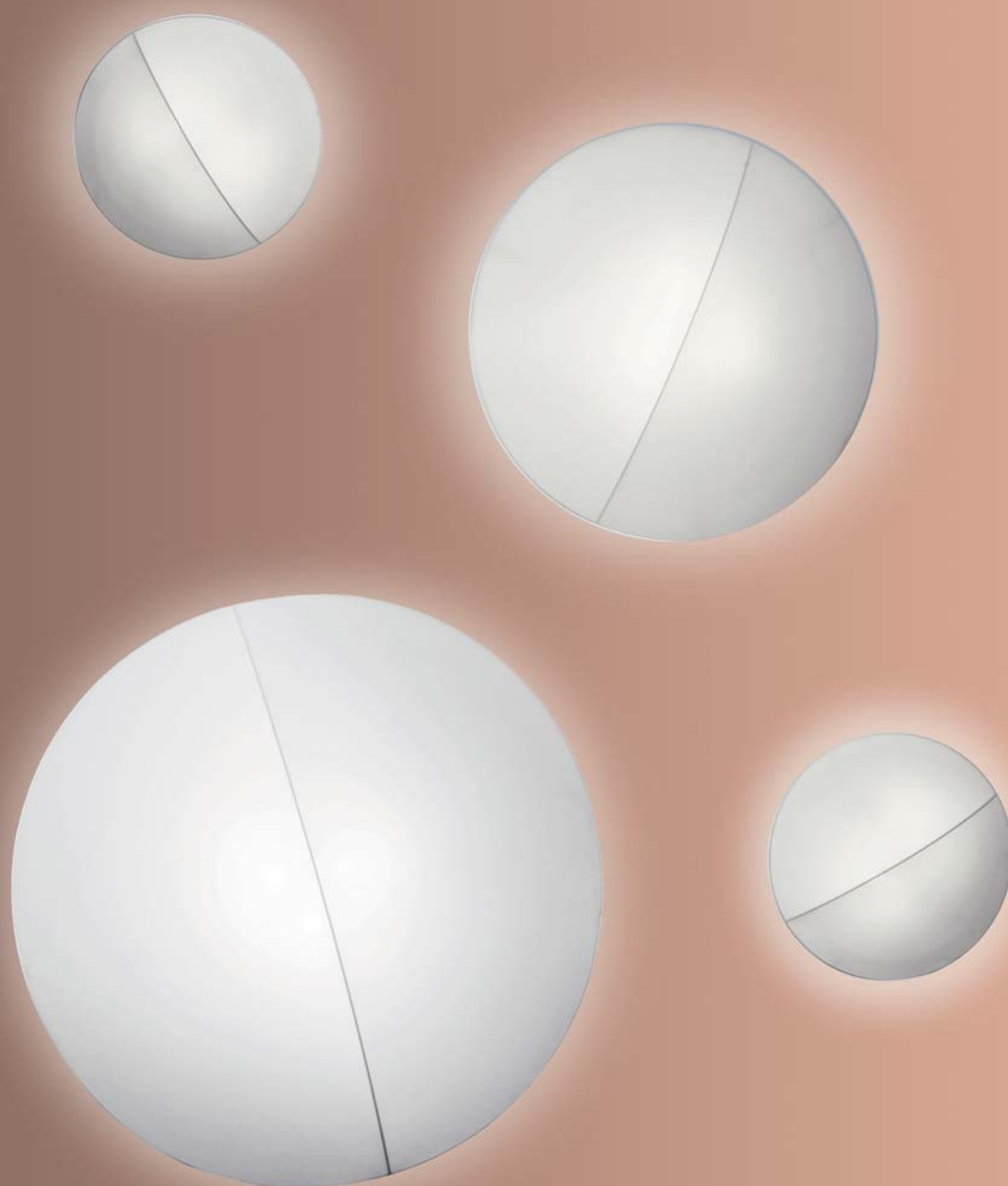

# Nelly Straight



# Orchid

Rainer Mutsch





L'incanto della natura con i suoi splendidi steli e boccioli trova espressione di design in Orchid. Fasci luminosi diretti come raggi di sole e intenso bagliore diffuso per caratterizzare con grazia ogni ambiente.

*Orchid design expresses the enchantment of nature with its splendid stems and buds. Direct light beams like rays of sun and intense diffused glow to gracefully characterize every space.*

S

M













L

XL

# Plumage

Vanessa Vivian



Meravigliose e grandi piume variopinte si sovrappongono ritmicamente, donando un profilo dinamico e leggero. Plumage fluttua nell'aria con eleganza maestosa e fiera, con immenso e inimitabile impatto visivo.

*Wonderful and large colorful feathers overlap rhythmically, giving a dynamic and weightless profile. Plumage floats in the air with majestic and proud elegance, with immense and inimitable visual impact.*

S

M

# Polia

Manuel Vivian

Come pagine mosse dal vento per sussurrare una bellissima storia. Polia è un racconto di luce intensa e inaspettata, che dona personalità e stile con discrezione e stupore.

*Like pages blown by the wind to whisper a beautiful story. Polia is a tale of intense and unexpected light, which discreetly gives personality and style.*

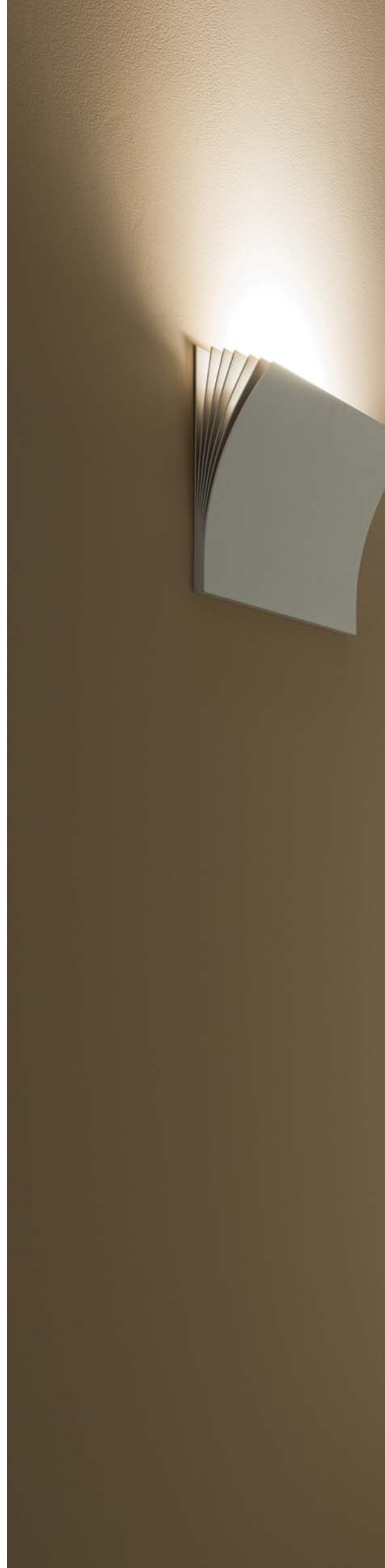





# Rythmos

S. & R. Cornellissen

Modernità spinta e perfezione del metallo bianco. Rythmos rappresenta l'essenzialità ritmica di forme squadrate che seducono gli ambienti con candida armonia.

*Powerful modernity and white metal perfection. Rythmos represents the rhythmic essentiality of square shapes that seduce the spaces into a candid harmony.*



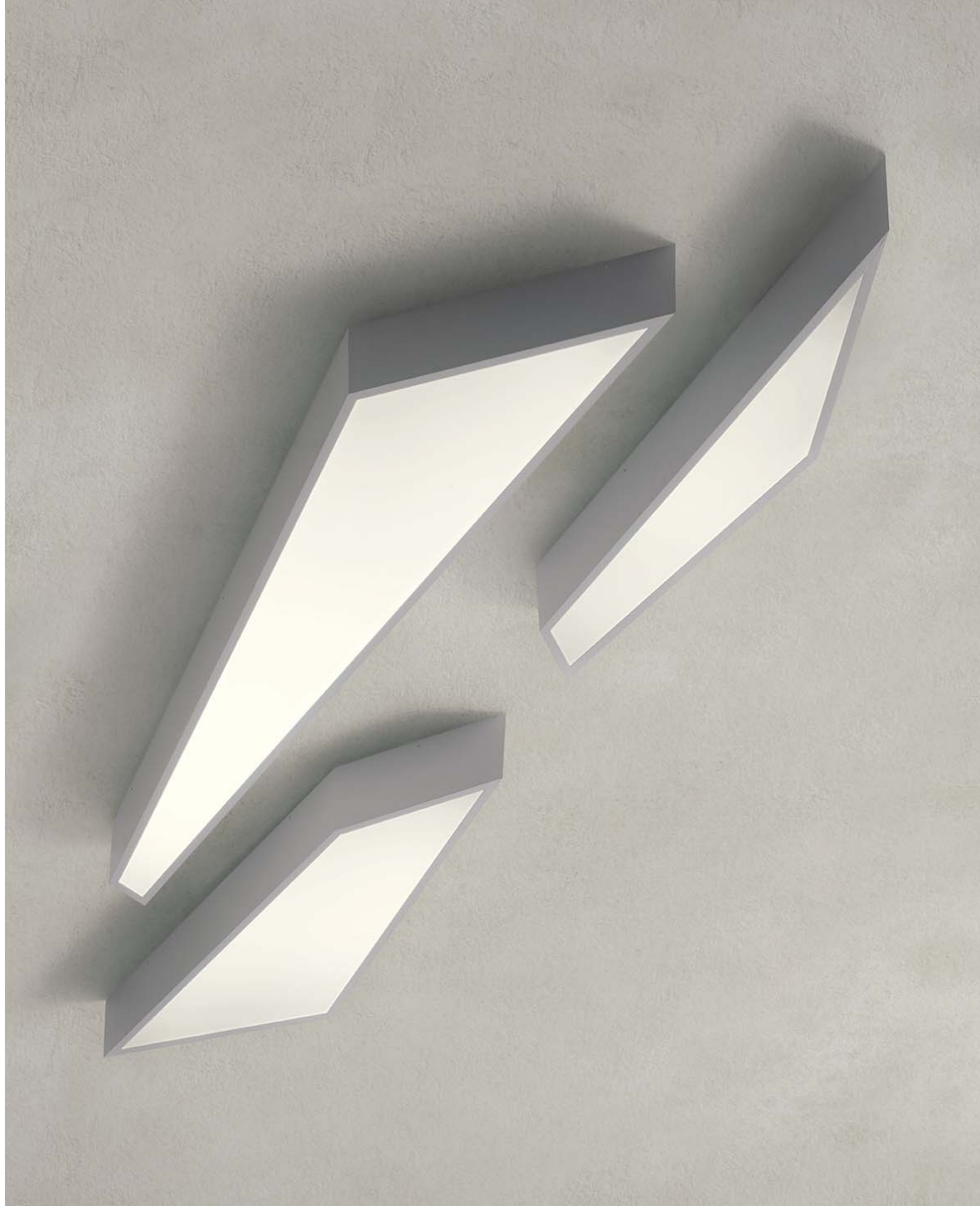

# Shatter

S. & R. Cornellissen

Leggerezza contemporanea nelle linee, purezza tecnologica dei materiali. Shatter plasma l'alluminio bianco e lo combina alla luce con uno stile squadrato e dinamico.

*Contemporary lightness in the lines, technological purity of the materials. Shatter shapes white aluminum and combines it with light in a polygonal and dynamic style.*



M

L

XL



# Skin

Manuel Vivian



M

L

XL



Razionalità raffinata di forma perfetta.

Skin si rivela nella sua semplicità con molteplici colori in ecopelle ignifuga e diverse dimensioni, donando unicità ed eleganza ad ogni ambiente.

*Refined rationality of perfect form.*

*Skin reveals itself in its simplicity with multiple colors in fireproof eco-leather and different sizes, giving uniqueness and elegance to any environment.*







L

XL

# Skirt

Manuel Vivian



Skirt è un racconto di ricchezza ed eleganza.  
La materia tattile e le forme sinuose danno origine  
a creazioni uniche, esclusive, da personalizzare  
con cromie variopinte e originalità di stile.

*Skirt is a story of wealth and elegance.  
The tactile matter and the sinuous forms conceive  
unique and exclusive creations, to be personalized  
with brilliantly varied colors and originality.*





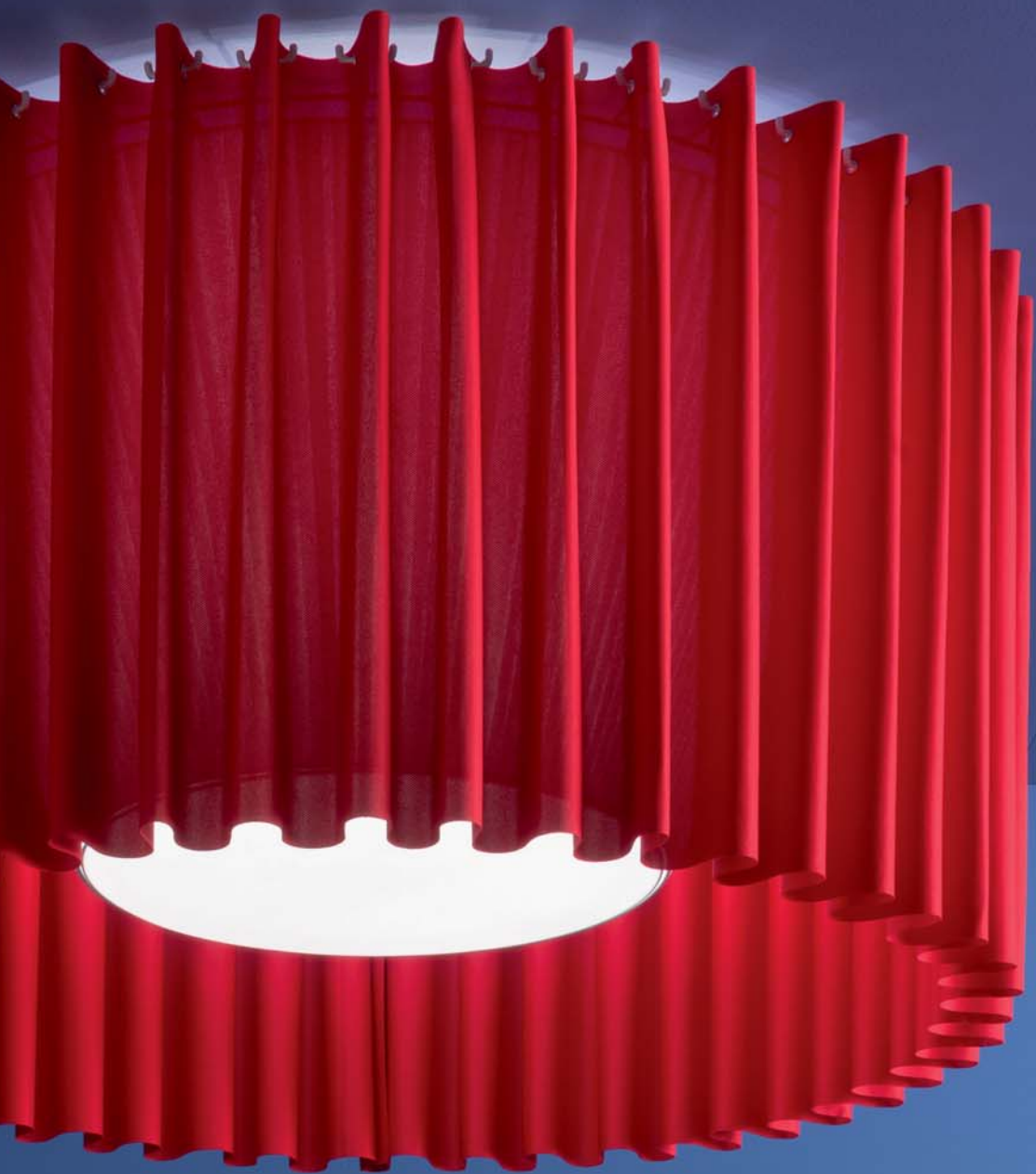



# Spillray

Manuel Vivian





S

M

L

XL



La delicatezza del vetro esprime una luce pura,  
ma dolcemente ricercata. Spillray è purezza dal design  
essenziale, capace di illuminare ogni ambiente  
con garbo e gentilezza.

*The delicacy of the glass expresses a pure but gently  
refined light. With its clean and essential design,  
Spillray is able to illuminate any space with grace  
and kindness.*





# Stilla

Manuel Vivian



Modernità ed evoluzione nell'equilibrio minimale di una goccia. Stilla è linearità decisa e puntuale, fluida nella forma, leggera nella materia.

*Modernity and evolution in the minimal balance of a drop. Decisive and punctual linearity, Stilla is fluid in the form and light in the material.*





# Stormy

Manuel Vivian





Elastica e malleabile, Stormy combina morbidezza ed estetica attraverso l'abbraccio con una flessuosa anima metallica. Movimenti e forme differenti da molteplici punti di vista.

*Elastic and malleable, Stormy combines softness and aesthetics through the embrace with a supple metallic soul. Different movements and shapes from multiple points of view.*

# U-Light

Timo Ripatti













L

XL

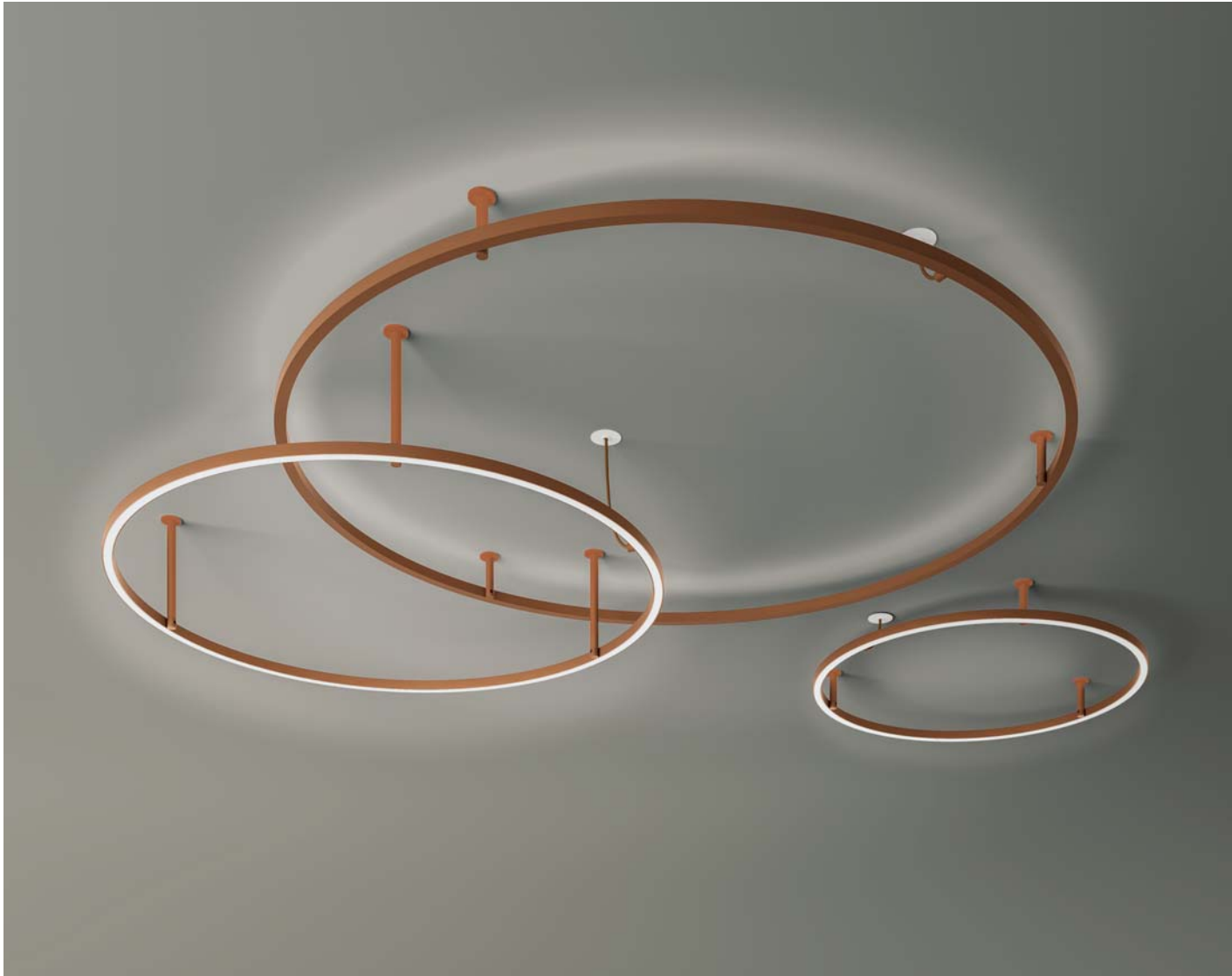

Disegno grafico essenziale e luce intensa. U-light esprime potenza ed efficienza luminosa enfatizzando l'essenza estetica, in un connubio armonico che sa lasciare un forte segno nello spazio.

Essential graphic design and intense light. U-light expresses power and luminous efficiency emphasizing the aesthetic essence in a harmonious union that creates a strong presence in the space.



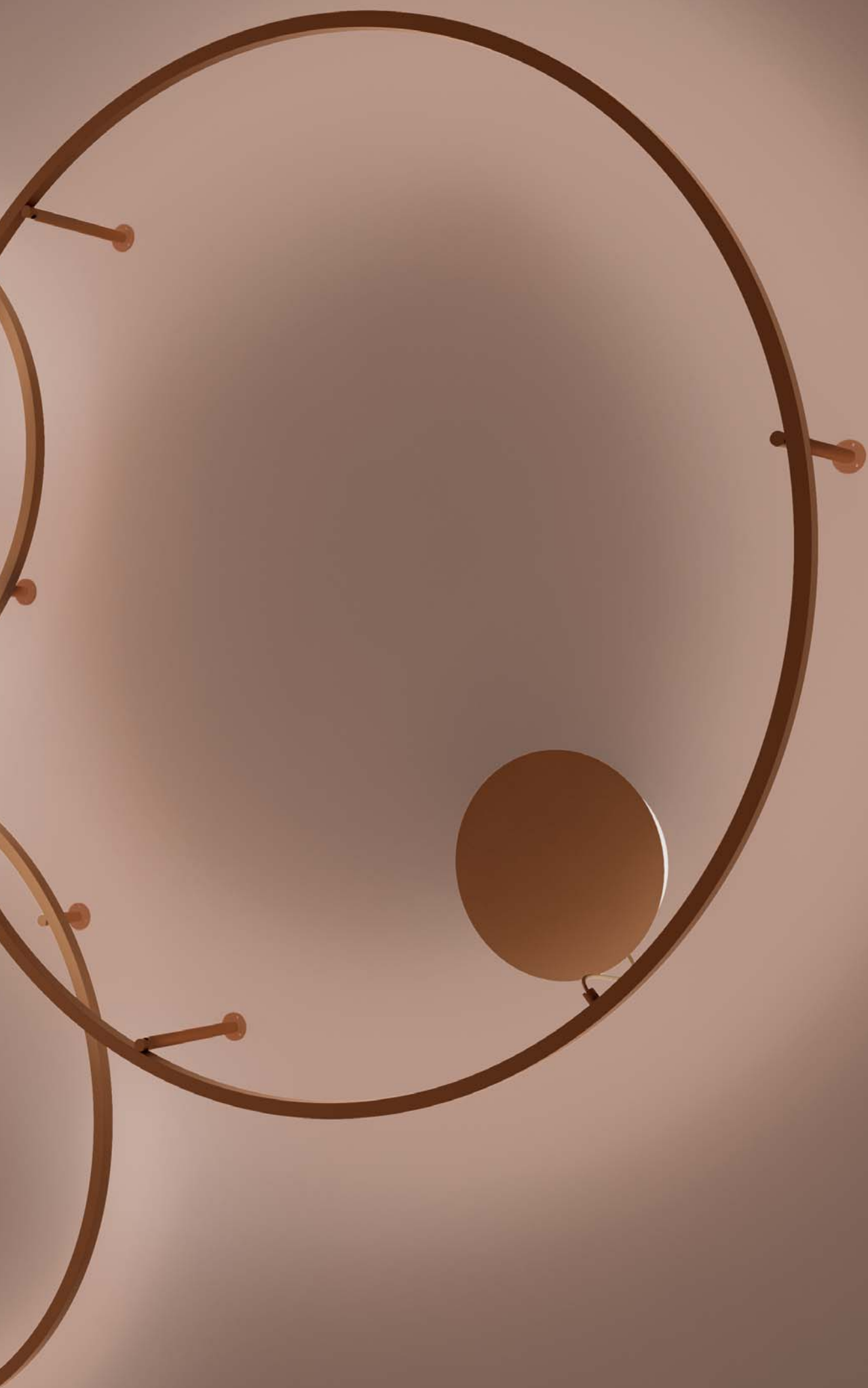



# Ukiyo

Manuel Vivian

Dinamica di linee e spigoli che plasmano flessuosi la duttile materia. Ukiyo è evoluzione della forma che non rimane mai statica, ma si trasforma e stupisce.

Dynamic of lines and edges that shape the flexible material. Ukiyo is an evolution of the form which is transformed, amazes and never remains static.

M | L

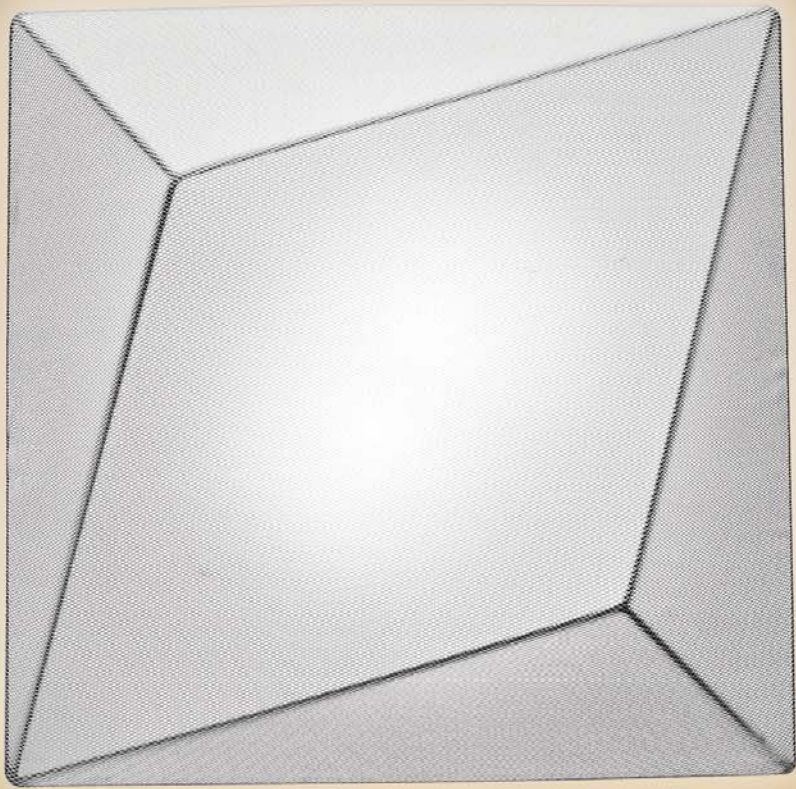

# Urban & Urban mini

Dima Loginoff



S

M



Estetica post industriale e performance all'avanguardia. Urban sa convertire forme geometriche semplici in un design unico, arricchito da finiture glamour e sofisticate.

*Post-industrial aesthetics and cutting-edge performance. Urban converts simple geometric shapes into a unique design, enriched with glamorous and sophisticated finishes.*











La forza audace del metallo domina lo spazio senza indugi. Uriel crea un potente segno di materia e luce nella parete, una simbiosi perfetta di stile.

*The bold strength of the metal dominates the space without hesitation. Uriel creates a powerful sign of matter and light in the wall. It is a perfect symbiosis of style.*

S M

# Uriel

Manuel Vivian



# Vasily

Manuel Vivian

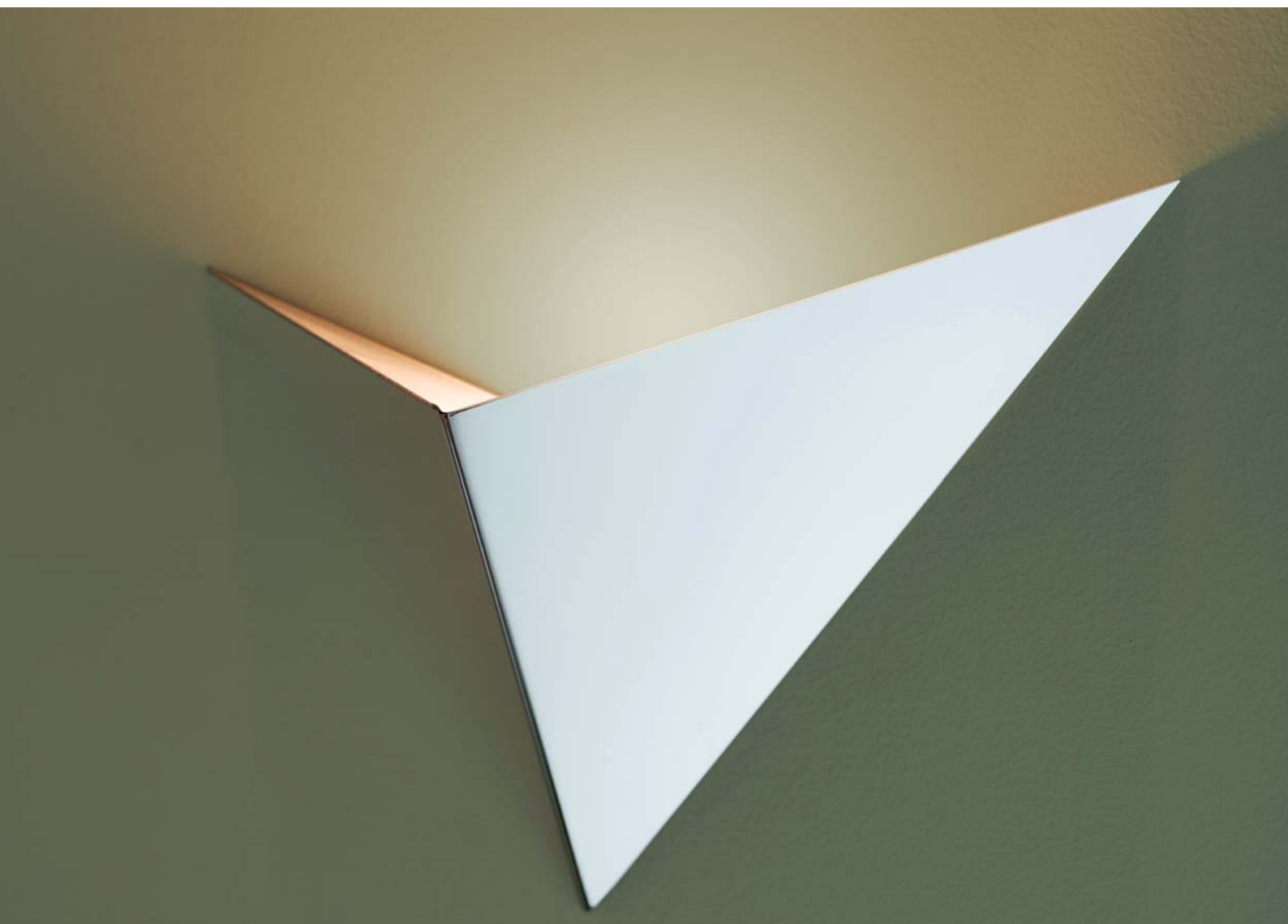

# S

Avanguardia futurista che osa con la forma per rompere gli schemi. Con i suoi spigoli di luce nella parete, Vasily gioca con i contrasti e sperimenta dinamiche innovative.

*Futurist avant-garde that dares with the shape to break the mold. Vasily plays with contrasts and experiments innovative dynamics with its edges of light in the wall.*







# Velvet

Manuel Vivian



M

L

XL

Materia tattile, colori variopinti, volumi differenti.  
Il tocco morbido di Velvet avvolge lo spazio con gusto  
e garbo, coinvolgendo tutti i sensi.

*Tactile matter, colorful shades, different volumes.  
The soft touch of Velvet envelops the space with  
style and grace, involving all the senses.*





# Virtus

Manuel Vivian

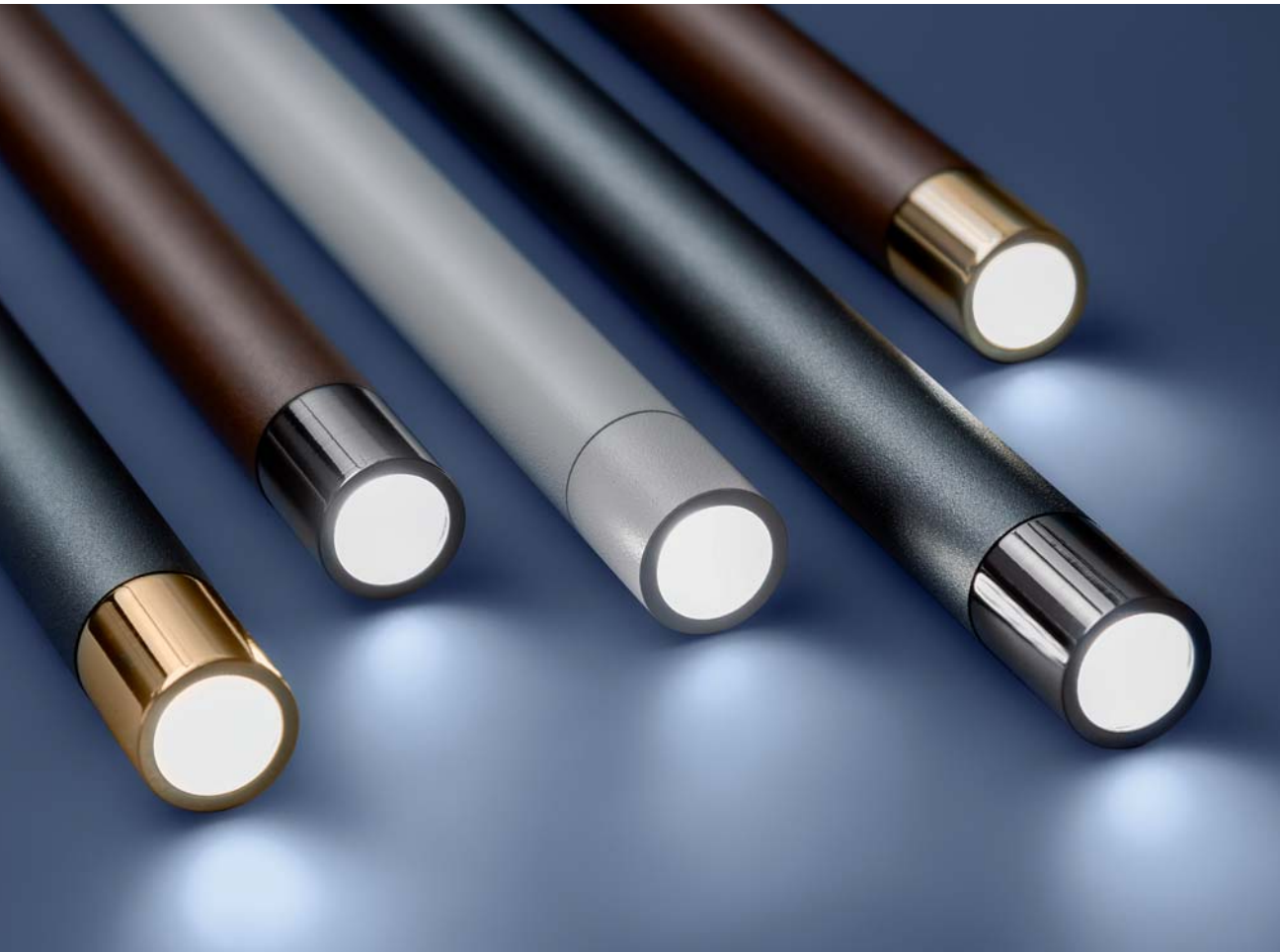

La semplicità lineare diventa eleganza pura.  
Virtus è un tratto di luce che combina leggerezza  
e grazia, generando progetti di architettura luminosa  
che personalizzano in modo unico lo spazio.

*Linear simplicity becomes pure elegance.  
Virtus is a stroke of light that combines lightness  
and grace, generating luminous architectural projects  
able to personalize the space in a very original way.*







# I designers

## The designers

### Axolight Lab

Team multidisciplinare, in grado di dare forma ad oggetti di design apparentemente irrealizzabili e di saper mettere in scena evocativi giochi di luce. A loro il merito di aver saputo rendere possibile lo sviluppo delle idee provenienti da tutti designer esterni che si avvicinano all'azienda.

Il team si diletta anche nella creazione di oggetti luminosi in autonoma creatività. L'ultimo oggetto concepito è Ego, la cui forma e flusso luminoso è un'indubbia sintesi di esperienza e creatività.

*A multidisciplinary team, able to give shape to apparently unattainable design objects and able to stage evocative games of light. It is their the merit of having been able to make possible the development of ideas coming from all external designers who approach the company. The team also enjoys creating lighting objects in creative autonomy. The last object conceived is Ego, whose shape and luminous flow is an undoubted synthesis of experience and creativity.*



### Giovanni Barbato

*Garbo, curve e materia.*

Collabora con Axolight da svariati anni, portano la sua firma le collezioni Aibu e Hoops, elegante e imponente sospensione in metallo in grado di illuminare, con una bi-emissione di luce diretta ed indiretta, e dare personalità a qualsiasi ambiente.

La conoscenza dei materiali e dei processi di trasformazione fanno di Giovanni Barbato uno fra i lighting designer di maggior valore della scena italiana.

*Grace, curves and malte.*

*Working with Axolight, from various several years now he has designed Aibu and Hoops collections. The last one is an elegant and imposing metal suspension able to illuminate, with a direct and indirect light emission, and give personality to any space. The knowledge of materials and the transformation processes make Giovanni Barbato one of the most valuable lighting designers on the Italian scene.*

### Davide Besozzi

*Luci e forme in movimento.*

Alla prima collaborazione con Axolight, è sua l'idea di Manto, lampada a sospensione capace di mutare forma ed effetto luminoso al variare della posizione della sfera in vetro soffiato, che può rimanere sospesa o finire immersa in un manto di tessuto. La chiarezza di stile, l'orientamento all'innovazione e l'amore per la ricerca fanno di Davide Besozzi uno fra i più talentuosi designer multidisciplinari emergenti.

*Lights and shapes in motion.*

*For his first collaboration with Axolight Davide Besozzi proposes: Manto. It is a suspension lamp able to change shape and lighting effect thanks to the variation of the position of the blown glass sphere, which can remain suspended or end up immersing in a fabric mantle.*

*The clarity of style, the orientation towards innovation and the love of research make Davide Besozzi one of the most talented emerging multidisciplinary designers.*







## Serge & Robert Cornelissen

*Eleganza informale.*

Lighting designer pluripremiati e di lungo corso, portano la loro firma le collezioni Rythmos, Shatter e Kwic, decisa ed elegante collezione di lampade da terra, da soffitto, a parete e a sospensione in alluminio e vetro soffiato nata dall'osservazione del comportamento del mercurio. Le loro creazioni si contraddistinguono per la grande capacità di coniugare forma e funzionalità tecniche.

*Informal elegance.*

*Long-established and award-winning lighting designers, they designed Rythmos, Shatter and Kwic collections. The last one is a strong and elegant collection which includes floor, ceiling, wall and suspension lamps in aluminum and blown glass. It was born from the observation of the behavior of mercury. Their creations are characterized by the great ability to combine form and technical functionality.*

## Riosuke Fukusada

*Sensualità e luce.*

Alla sua prima collaborazione con Axolight, è sua l'idea di Alysoïd, sinuosa collezione di sospensioni in alluminio ed ottone. La filosofia artistica si contraddistingue per la straordinaria capacità di coniugare forme curvilinee e praticità luminosa. Curiosità, stile e studio accurato delle tecniche manifatturiere fanno di Riosuke Fukusada uno fra i designer più coinvolgenti della scena contemporanea.

*Sensuality and light.*

*From the first collaboration between Riosuke Fukusada and Axolight results Alysoïd, a sinuous collection of suspension lamps in aluminum and brass. The artistic philosophy is characterized by the extraordinary ability to combine curvilinear forms and luminous functionality. Curiosity, style and careful study of manufacturing techniques make Riosuke Fukusada one of the most engaging designers of the contemporary scene.*





## Dima Loginoff

Personalità in luce.

Fra i più affermati e premiati lighting designer della scena contemporanea, portano la sua firma le collezioni Fedora, Mountain View, Urban e Cloudy. Dotato di coraggio ed estrema sensibilità artistica, a Dima va il merito di aver saputo avvicinare al mondo del lighting design forme apparentemente lontane. Le ricorrenti collaborazioni con Axolight sono definibili come delle vere e proprie sfide verso nuovi traguardi estetici.

*Personality in the spotlight.*

*Among the most successful and award-winning lighting designers on the contemporary scene, Dima Loginoff designed Fedora, Mountain View, Urban and Cloudy collections. Thanks to his courage and strong artistic sensitivity, Dima Loginoff has been able to approach shapes apparently distant to the world of lighting design. The multiple collaborations with Axolight can be defined as real progressions towards new aesthetic goals.*

## Sara Moroni

Ingegno, armonia ed eleganza.

Alla sua prima collaborazione con Axolight, è sua l'idea di Liaison, sistema modulare di sospensioni, rara sintesi di carattere, eleganza e razionalità progettuale. Unica nel suo genere, Sara è sicuramente una delle designer multidisciplinari più affascinanti della scena contemporanea.

*Ingenuity, harmony and elegance.*

*In her first collaboration with Axolight, Sara Moroni conceived the Liaison collection, a modular suspension system describing a rare synthesis of character, elegance and design rationality. Unique in her genre Sara Moroni is certainly one of the most fascinating multidisciplinary designers on the contemporary scene.*



## Rainer Mutsch

Grazia, modernità e conoscenza.

Designer multidisciplinare di lungo corso, fra i più affermati e stimolanti della scena europea.

Alla sua prima collaborazione con Axolight, è sua l'idea di Orchid, famiglia di lampade da terra, da tavolo, a parete, a soffitto e a sospensione. A bordo linea fra il modernismo ed il post minimalismo, Orchid è indubbiamente una fra le più apprezzate lampade della scena contemporanea.

*Elegance, modernity and knowledge.*

*Rainer Mutsch is one of the most successful, inspiring and long-time multidisciplinary designers on the European scene. In his first collaboration with Axolight, he designed Orchid, a collection which includes floor, table, wall, ceiling and suspension lamps.*

*Between modernism and post-minimalism, Orchid is undoubtedly one of the most popular lamps on the contemporary scene.*

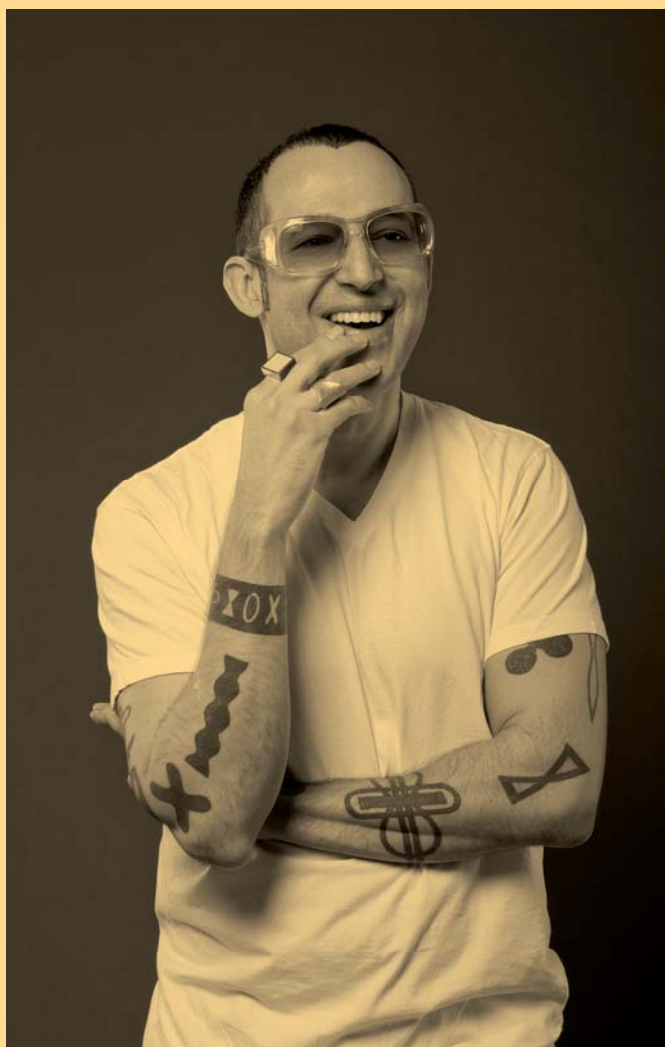

## Karim Rashid

Estro e creatività.

Pluripremiato archistar internazionale, è sua l'idea di Nafir, collezione di sospensioni e plafoniere che richiama la forma di uno strumento musicale.

Dotato di una eccezionale personalità è in grado di rendere riconoscibile ogni sua creazione.

*Inspiration and creativity.*

*Award-winning international archistar, Karim Rashid designed Nafir, a collection of suspensions and ceiling lamps reminiscent of the shape of a musical instrument. He has an exceptional personality and he is able to make every creation recognizable.*

## Timo Ripatti

Carattere e modernità.

Espressione del processo di rinnovamento di Axolight degli ultimi anni. Ideatore di opere essenziali, veri e propri disegni nello spazio, come nel caso di U-Light, e di oggetti dal sapore post industriale, materici e meccanicamente direzionabili, come nel caso di Cut. È sicuramente uno fra i designer più intriganti e coinvolgenti dei nostri giorni.

*Character and modernity.*

*Timo Ripatti is the expression of the Axolight renewal process over the past few years. He is a creator of essential works, real drawings in space, as in the case of U-Light, and objects with a post-industrial taste, material and mechanically directable, as in the case of Cut. He is certainly one of the most intriguing and engaging designers in this day and age.*



## Sandro Santantonio

Eccellenza armoniche.

Affermato designer multidisciplinare, fra i più prolifici della scena contemporanea, portano la sua firma le collezioni Muse e Melting Pot, una collezione di lampade a sospensione e da terra in grado di dare un'identità unica ed armonica ad un complesso di forme e grafiche differenti fra loro.

*Harmonic versatility.*

*Sandro Santantonio is a successful multidisciplinary designer, one of the most prolific on the contemporary scene. He designed Muse and Melting Pot collections. The last one is a collection of suspension and floor lamps that can give a unique and harmonious identity to a complex of different shapes and graphics.*

## Manuel e Vanessa Vivian

Cultura e artigianalità.

Manuel Vivian, designer di lunga esperienza, è custode inconsapevole della migliore tradizione artistica e manifatturiera italiana. Cultore dei processi produttivi artigianali, nelle sue creazioni non pone alcun limite alla sperimentazione. Sono frutto dell'idea creativa di Manuel alcune fra le più importanti collezioni storiche di Axolight: Bell, Skin, Skirt, Spillray, Fairy, Aura, Clavius, Virtus, Polia, Framework.

Vanessa, talentuosa figlia d'arte, è la mente creativa delle collezioni Layers e Plumage, oggetti che sembrano derivare dall'estro e dall'esperienza di designer maturi e completi, ma che al contrario provengono dall'immaginazione e dalla visione incontaminata di una giovane designer, eccellente portabandiera di una grande eredità familiare.

*Culture and craftsmanship.*

*Manuel Vivian, a long-experienced designer, is an unwitting guardian of the best in Italian artistic and manufacturing tradition. He is an expert in artisan production processes, in his creations he sets no limits to experimentation. Some of the most important historical collections of Axolight are the result of Manuel's creative idea: Bell, Skin, Skirt, Spillray, Fairy, Aura, Clavius, Virtus, Polia, Framework.*

*Vanessa, a talented daughter following the footsteps of her father, is the creative mind behind the Layers and Plumage collections, objects that seem to come from the inspiration and experience of mature and complete designers, rather than the imagination and uncontaminated vision of a young designer, an excellent standard-bearer of a great family legacy.*



## Studio Yonoh

Alex Selma and Clara del Portillo

Contemporaneità e vision.

Studio creativo multidisciplinare, fondato dai designer Clara del Portillo e Alex Selma. Alla prima collaborazione con Axolight, è loro l'idea di Jewel, pendente di piccole dimensioni, sintesi armonica fra le necessità funzionali e la vocazione decorativa della lampada. Studio Yonoh è oggi uno fra gli studi di design più premiati della scena internazionale. Semplicità, carattere ed innovazione sono sicuramente i primi tre elementi distintivi della loro moderna filosofia progettuale.

*Contemporaneity and vision.*

*Multidisciplinary creative studio founded by designers Clara del Portillo and Alex Selma. Jewel represents the first collaboration between Studio Yonoh and Axolight. It is a small pendant, a harmonious synthesis between functional needs and the decorative vocation of the lamp. Studio Yonoh is one of the most awarded design studios on the international scene in this day and age. Simplicity, character and innovation are certainly the distinctive elements of their modern design philosophy.*



## Dati tecnici / technical data

aibu	175	orchid	246
alysoid	176	plumage	249
aura (avir)	178	polia	251
ax20	183	rythmos	252
bell	185	shatter	253
clavius	192	skin	255
cloudy	195	skirt	260
cut	196	spillray	270
ego	198	stillia	279
fairy	199	stormy	280
favilla	203	u-light	281
fedora	204	ukiyo	289
framework	206	urban	290
hoops	208	urban mini	293
jewel	210	uriel	297
kwic	212	vasily	298
layers	214	velvet	299
liaison	218	virtus	304
lik	227	lampadine / lamp bulbs	306
manto	228	driver for ego - 250mA	307
melting pot	230	driver 350mA	308
mountain view	234	driver for spillray / u-light / transformer	309
muse	235	legenda / legend	310
nafir	241	EEL compatibility	310
nelly	242		
nelly straight	244		





# Aibu

Giovanni Barbato

Lampada da tavolo in vetro triplex soffiato e lavorato a mano, bianco.  
Sorgente luminosa a LED con attacco G9.

Table lamp in white triplex handmade blown glass. LED light source with G9 fitting.

## COLOUR



white

## LT AIBU

kg 1.8 m<sup>3</sup> 0.004

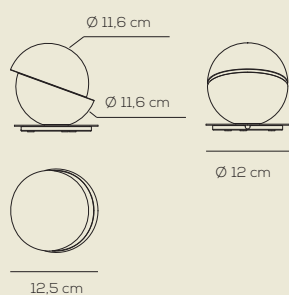

### AIBU

Type	Article	Colours	Finish	Source
LT	AIBU XX	BC white	BC white	G9L G9 LED 1x Max 2,5W only LED bulbs

Gli articoli in rosso sono disponibili solo fino ad esaurimento scorte. *Articles in red are available until sold out.*

CE □ IP20 LED 220-240V<sub>AC</sub>

**Attenzione: ordine minimo 2 pezzi. / Attention: minimum order 2 pieces.**

example composition code LT AIBUXX BC BC G9L

optional for more info see page 306

 LAMPG92,5WL2701 G9 LED bulb 2,5W - 2700K - 330° angle (\*)

# Alysoid

Ryosuke Fukusada

Collezione di lampade a sospensione in alluminio. Disponibile in vari colori e dimensioni. La sorgente luminosa è a LED integrato dimmerabile.

Collection consisting of aluminium suspended lamps. Available in several colours and sizes. Built-in dimmable LED light source.

## COLOURS



anthracite grey wrinkled / chains: black polished nickel

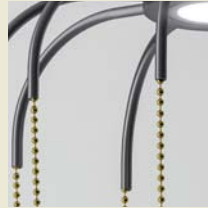

anthracite grey wrinkled / chains: natural brass



anthracite grey canopy

## SP ALYS 34

kg 2.5 m<sup>3</sup> 0.04

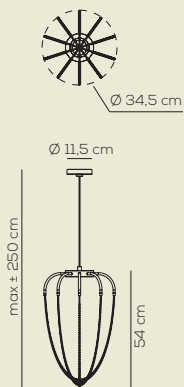

### ALYSOID

Type	Article	Colours	Catene / chains	Source
SP	ALYS 34	AN anthracite grey wrinkled	NI black polished nickel OT natural brass	LED 20W - diffused beam 3000K*, 2700K

IP20 CRI90 220-240V<sub>AC</sub> **LED** ~1800 lm\* 90 lm/W\*

example composition code SP ALYS34 AN OT LED

## SP ALYS 43

kg 3.2 m<sup>3</sup> 0.06

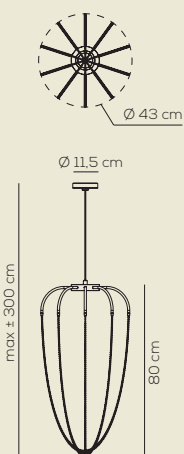

### ALYSOID

Type	Article	Colours	Catene / chains	Source
SP	ALYS 43	AN anthracite grey wrinkled	NI black polished nickel OT natural brass	LED 20W - diffused beam 3000K*, 2700K

IP20 CRI90 220-240V<sub>AC</sub> **LED** ~1800 lm\* 90 lm/W\*

example composition code SP ALYS43 AN NI LED

# Alysoid

Ryosuke Fukusada

Collezione di lampade a sospensione in alluminio. Disponibile in vari colori e dimensioni.  
La sorgente luminosa è a LED integrato dimmerabile.

Collection consisting of aluminium suspended lamps. Available in several colours and sizes.  
Built-in dimmable LED light source.

## SP ALY 51 P

kg 3.7 m<sup>3</sup> 0.11

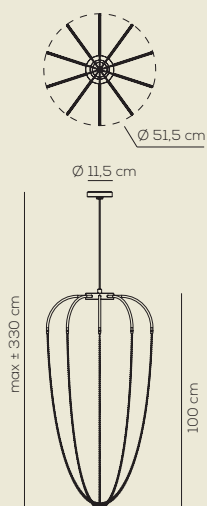

### ALYSOID

Type	Article	Colours	Catene / chains	Source
SP	ALY 51 P	AN anthracite grey wrinkled	NI black polished nickel OT natural brass	LED 20W - diffused beam 3000K*, 2700K

IP20 CRI90 220-240VAc **LED** ~1800 lm\* 90 lm/W\*

example composition code SP ALY51P AN OT LED

## SP ALY 51 G

kg 4.5 m<sup>3</sup> 0.11

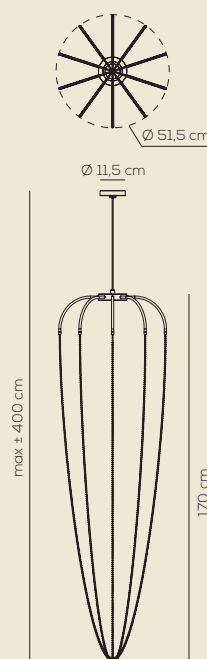

### ALYSOID

Type	Article	Colours	Catene / chains	Source
SP	ALY 51 G	AN anthracite grey wrinkled	NI black polished nickel OT natural brass	LED 20W - diffused beam 3000K*, 2700K

IP20 CRI90 220-240VAc **LED** ~1800 lm\* 90 lm/W\*

example composition code SP ALY51G AN NI LED

# Aura (Avir)

Manuel Vivian

Collezione composta da lampade da parete, lampade da soffitto, lampade a sospensione, con pendenti in vetro di Murano colorato incamiciato cristallo e ritorti a mano. Disponibile in vari colori e dimensioni. Sorgente luminosa con attacco a vite.

Collection consisting of wall lamps, ceiling lamps and suspended lamps with double-layered coloured Murano glass hand twisted pendants. Available in several colours and sizes. Screw fitting light source.

## COLOURS

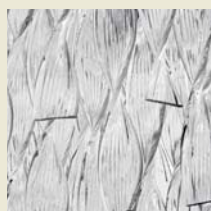

"rigadin" crystal



white

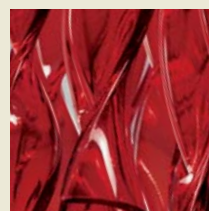

red

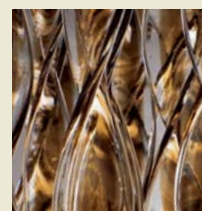

tea

## CEILING VERSION



chrome



gold leaf

## SUSPENSION VERSION

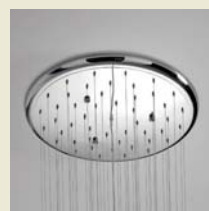

chrome

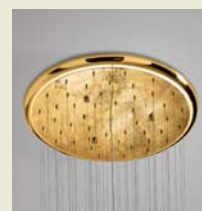

gold leaf

## AP AURA

kg 16.5 m<sup>3</sup> 0.26

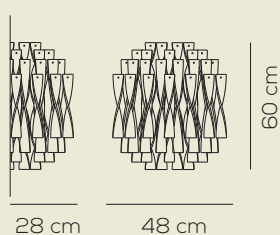

## AURA

Type	Article	Colours	Finish	Source
AP	AURA XX	CS "rigadin" crystal BC white RS red TA tea	CR chrome	E27 2 x Max 20W LED or 2 x Max 100W halo
AP	AURA XX	CS "rigadin" crystal BC white RS red TA tea	OR gold leaf	E27 2 x Max 20W LED or 2 x Max 100W halo

Gli articoli in rosso sono disponibili solo fino ad esaurimento scorte. Articles in red are available until sold out.

CE IP20 +LED 220-240V<sub>ac</sub>

example composition code AP AURA XX RS OR E27

# Aura (Avir)

Manuel Vivian

Collezione composta da lampade da parete, lampade da soffitto, lampade a sospensione, con pendenti in vetro di Murano colorato incamiciato cristallo e ritorti a mano. Disponibile in vari colori e dimensioni. Sorgente luminosa con attacco a vite.

Collection consisting of wall lamps, ceiling lamps and suspended lamps with double-layered coloured Murano glass hand twisted pendants. Available in several colours and sizes. Screw fitting light source.

## PL AUR P 30

kg 22 m<sup>3</sup> 0.33

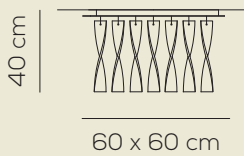

AURA				
Type	Article	Colours	Finish	Source
PL	AUR P 30	CS "rigadin" crystal BC white RS red TA tea	CR chrome	E27 4 x Max 20W LED or 4 x Max 100W halo
PL	AUR P 30	CS "rigadin" crystal BC white RS red TA tea	OR gold leaf	E27 4 x Max 20W LED or 4 x Max 100W halo

Gli articoli in rosso sono disponibili solo fino ad esaurimento scorte. Articles in red are available until sold out.

CE IP20 +LED 220-240V<sub>AC</sub>

example composition code PL AURP30 CS CR E27

## PL AURA P

kg 26.5 m<sup>3</sup> 0.45

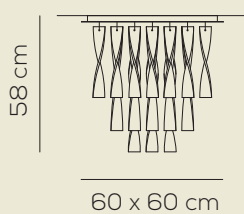

AURA				
Type	Article	Colours	Finish	Source
PL	AURA P X	CS "rigadin" crystal BC white RS red TA tea	CR chrome	E27 4 x Max 20W LED or 4 x Max 100W halo
PL	AURA P X	CS "rigadin" crystal BC white RS red TA tea	OR gold leaf	E27 4 x Max 20W LED or 4 x Max 100W halo

Gli articoli in rosso sono disponibili solo fino ad esaurimento scorte. Articles in red are available until sold out.

CE IP20 +LED 220-240V<sub>AC</sub>

example composition code PL AURA PX RS OR E27

# Aura (Avir)

Manuel Vivian

Collezione composta da lampade da parete, lampade da soffitto, lampade a sospensione, con pendenti in vetro di Murano colorato incamiciato cristallo e ritorti a mano. Disponibile in vari colori e dimensioni. Sorgente luminosa con attacco a vite.

Collection consisting of wall lamps, ceiling lamps and suspended lamps with double-layered coloured Murano glass hand twisted pendants. Available in several colours and sizes. Screw fitting light source.

## PL AUR G 30

kg 24.5 m<sup>3</sup> 0.44

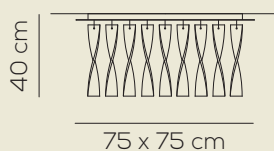

AURA				
Type	Article	Colours	Finish	Source
PL	AUR G 30	CS "rigadin" crystal BC white RS red TA tea	CR chrome	E27 4 x Max 20W LED or 4 x Max 100W halo
PL	AUR G 30	CS "rigadin" crystal BC white RS red TA tea	OR gold leaf	E27 4 x Max 20W LED or 4 x Max 100W halo

Gli articoli in rosso sono disponibili solo fino ad esaurimento scorte. Articles in red are available until sold out.

CE IP20 +LED 220-240V<sub>AC</sub>

example composition code PL URG30 RS OR E27

## PL AURA GR

kg 44 m<sup>3</sup> 0.62

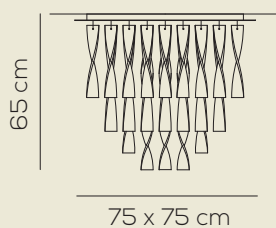

AURA				
Type	Article	Colours	Finish	Source
PL	AURA GR	CS "rigadin" crystal BC white RS red TA tea	CR chrome	E27 4 x Max 20W LED or 4 x Max 100W halo
PL	AURA GR	CS "rigadin" crystal BC white RS red TA tea	OR gold leaf	E27 4 x Max 20W LED or 4 x Max 100W halo

Gli articoli in rosso sono disponibili solo fino ad esaurimento scorte. Articles in red are available until sold out.

CE IP20 +LED 220-240V<sub>AC</sub>

example composition code PL AURAGR BC OR E27

# Aura (Avir)

Manuel Vivian

Collezione composta da lampade da parete, lampade da soffitto, lampade a sospensione, con pendenti in vetro di Murano colorato incamiciato cristallo e ritorti a mano. Disponibile in vari colori e dimensioni. Sorgente luminosa con attacco a vite.

Collection consisting of wall lamps, ceiling lamps and suspended lamps with double-layered coloured Murano glass hand twisted pendants. Available in several colours and sizes. Screw fitting light source.

## SP AURA 45

kg 19 m<sup>3</sup> 0.33

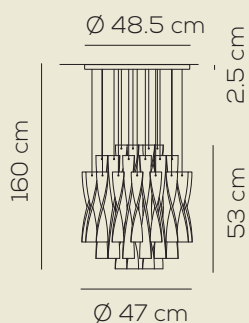

### AURA

Type	Article	Colours	Finish	Source
SP	AURA 45	CS "rigadin" crystal  BC white  RS red  TA tea	CR chrome	E27 1 x Max 27W LED or 1 x Max 150W halo
SP	AURA 45	CS "rigadin" crystal  BC white  RS red  TA tea	OR gold leaf	E27 1 x Max 27W LED or 1 x Max 150W halo

Gli articoli in rosso sono disponibili solo fino ad esaurimento scorte. Articles in red are available until sold out.

CE IP20 +LED 220-240V<sub>AC</sub>

example composition code SP AURA45 BC OR E27

## SP AU 45/2

kg 30 m<sup>3</sup> 0.57

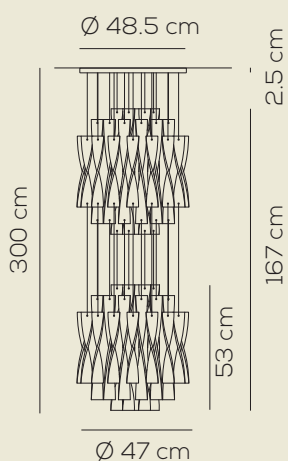

### AURA

Type	Article	Colours	Finish	Source
SP	AU 45/2	CS "rigadin" crystal  BC white  RS red  TA tea	CR chrome	E27 2 x Max 20W LED or 2 x Max 150W halo
SP	AU 45/2	CS "rigadin" crystal  BC white  RS red  TA tea	OR gold leaf	E27 2 x Max 20W LED or 2 x Max 150W halo

Gli articoli in rosso sono disponibili solo fino ad esaurimento scorte. Articles in red are available until sold out.

CE IP20 +LED 220-240V<sub>AC</sub>

example composition code SP AU 45/2 BC CR E27

# Aura (Avir)

Manuel Vivian

Collezione composta da lampade da parete, lampade da soffitto, lampade a sospensione, con pendenti in vetro di Murano colorato incamiciato cristallo e ritorti a mano. Disponibile in vari colori e dimensioni. Sorgente luminosa con attacco a vite.

Collection consisting of wall lamps, ceiling lamps and suspended lamps with double-layered coloured Murano glass hand twisted pendants. Available in several colours and sizes. Screw fitting light source.

## SP AURA 60

kg 28 m<sup>3</sup> 0.48

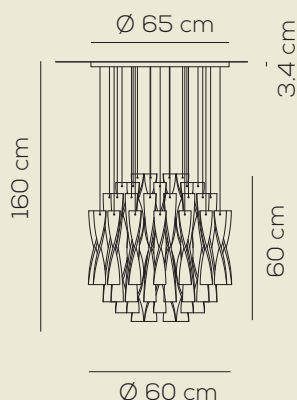

AURA				
Type	Article	Colours	Finish	Source
SP	AURA 60	CS "rigadin" crystal BC white RS red TA tea	CR chrome	E27 1 x Max 35W LED or 1 x Max 250W halo
SP	AURA 60	CS "rigadin" crystal BC white RS red TA tea	OR gold leaf	E27 1 x Max 35W LED or 1 x Max 250W halo

Gli articoli in rosso sono disponibili solo fino ad esaurimento scorte. Articles in red are available until sold out.

CE IP20 +LED 220-240V<sub>AC</sub>

example composition code PL AURA60 RS OR E27

## SP AU 60/2

kg 45 m<sup>3</sup> 0.84

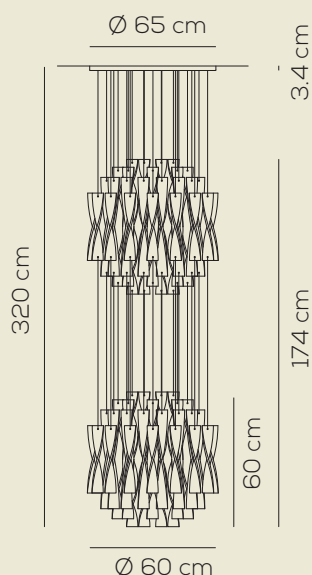

AURA				
Type	Article	Colours	Finish	Source
SP	AU 60/2	CS "rigadin" crystal BC white RS red TA tea	CR chrome	E27 2 x Max 20W LED or 2 x Max 250W halo
SP	AU 60/2	CS "rigadin" crystal BC white RS red TA tea	OR gold leaf	E27 2 x Max 20W LED or 2 x Max 250W halo

Gli articoli in rosso sono disponibili solo fino ad esaurimento scorte. Articles in red are available until sold out.

CE IP20 +LED 220-240V<sub>AC</sub>

example composition code SP AU 60/2 BC OR E27



# AX 20

Manuel Vivian

Collezione composta da lampade da parete, lampade a sospensione e lampade da terra in metallo cromato. Disponibile in varie dimensioni. Sorgente luminosa con attacco G9.

Collection consisting of wall lamps, suspended lamps and floor lamps with chrome-plated finish. Available in several sizes. Light source with G9 fitting.

## COLOURS

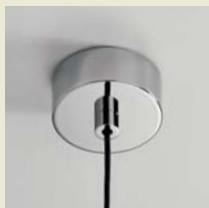

suspension canopy



floor lamp detail

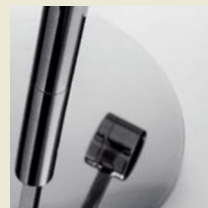

floor lamp detail

## AP AX20 PI

kg 1 m<sup>3</sup> 0.01

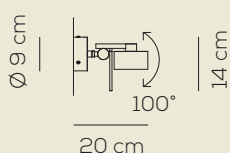

**AX 20** / applicazione a soffitto o a parete / application: both as ceiling or wall lamp

Type	Article	Colours	Finish	Source
AP	AX20 PI	XX chrome	CR chrome	G9X G9 1 x Max 60W halo

Gli articoli in rosso sono disponibili solo fino ad esaurimento scorte. Articles in red are available until sold out.

CE IP20 220-240V<sub>AC</sub>  
example composition code AP AX20PI XX CR G9X

## AP AX20 GR

kg 1.5 m<sup>3</sup> 0.016

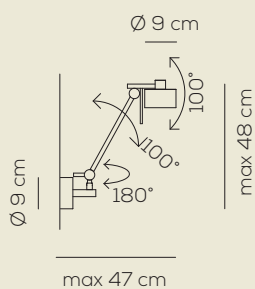

**AX 20**

Type	Article	Colours	Finish	Source
AP	AX20 GR	XX chrome	CR chrome	G9X G9 1 x Max 60W halo

Gli articoli in rosso sono disponibili solo fino ad esaurimento scorte. Articles in red are available until sold out.

CE IP20 220-240V<sub>AC</sub>  
example composition code AP AX20GR XX CR G9X

# AX 20

Manuel Vivian

Collezione composta da lampade da parete, lampade a sospensione e lampade da terra in metallo cromato. Disponibile in varie dimensioni. Sorgente luminosa con attacco G9.

Collection consisting of wall lamps, suspended lamps and floor lamps with chrome-plated finish. Available in several sizes. Light source with G9 fitting.

## SP AX20 PI

kg 0.8 m<sup>3</sup> 0.005

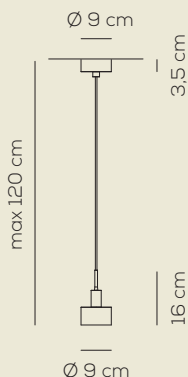

### AX 20

Type	Article	Colours	Finish	Source
SP	AX20 PI	XX chrome	CR chrome	G9X G9 1 x Max 60W halo

Gli articoli in rosso sono disponibili solo fino ad esaurimento scorte. Articles in red are available until sold out.



IP20 220-240V<sub>AC</sub>

example composition code SP AX20PI XX CR G9X

## PT AX20

kg 6 m<sup>3</sup> 0.11

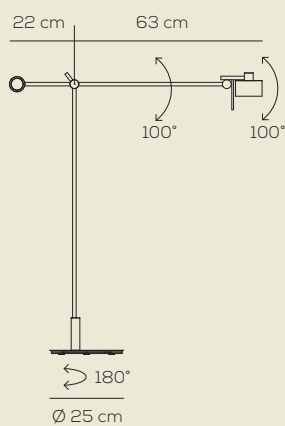

### AX 20

Type	Article	Colours	Finish	Source
PT	AX20 XX	XX chrome	CR chrome	G9X G9 1 x Max 60W halo

Gli articoli in rosso sono disponibili solo fino ad esaurimento scorte. Articles in red are available until sold out.



IP20  220-240V<sub>AC</sub>

example composition code PT AX20XX XX CR G9X

# Bell

Manuel Vivian

Collezione composta da lampade da soffitto e lampade a sospensione con struttura metallica rivestita con fettuccia di tessuto ignifugato pongé superliscio. Disponibile in vari colori e dimensioni. Sorgente luminosa con attacco a vite o a LED integrato dimmerabile.

Collection consisting of ceiling lamps and suspended lamps with a metal frame covered with strips of extra smooth flame-retardant pongé fabric. Available in several colours and sizes. Screw fitting or built-in dimmable LED light source.

## COLOURS



white



electric blue



warm white

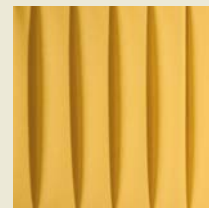

gold yellow



brown

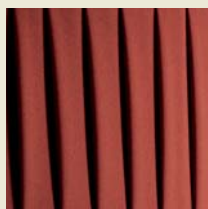

brick red



black

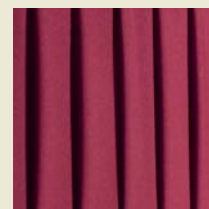

burgundy

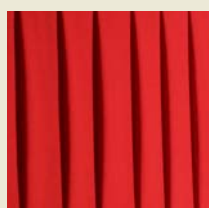

red



green



diffuser detail



white canopy

## PL BEL 060

kg 4 m<sup>3</sup> 0.18

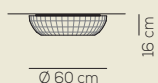

BELL / diffusore INCLUSO / diffuser INCLUDED

Type	Article	Colours	Finish	Source
PL	BEL 060 E27	<b>BC</b> white  <b>BL</b> electric blue  <b>BW</b> warm white  <b>GI</b> gold yellow  <b>MA</b> brown  <b>MT</b> brick red  <b>NE</b> black  <b>RB</b> burgundy  <b>RS</b> red  <b>VE</b> green	XX	E27 2 x Max 16W LED or 2 x Max 57W halo

CE IP20 +LED 220-240V<sub>AC</sub>

example composition code PL BEL060E27 GI XX

# Bell

Manuel Vivian

Collezione composta da lampade da soffitto e lampade a sospensione con struttura metallica rivestita con fettuccia di tessuto ignifugato pongé superliscio. Disponibile in vari colori e dimensioni. Sorgente luminosa con attacco a vite o a LED integrato dimmerabile.

*Collection consisting of ceiling lamps and suspended lamps with a metal frame covered with strips of extra smooth flame-retardant pongé fabric. Available in several colours and sizes. Screw fitting or built-in dimmable LED light source.*

## PL BEL 090

kg 8 m<sup>3</sup> 0.98

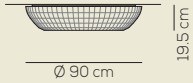

BELL / diffusore INCLUSO / diffuser INCLUDED

Type	Article	Colours	Finish	Source
PL	BEL 090 E27	<b>BC</b> white <b>BL</b> electric blue <b>BW</b> warm white <b>GI</b> gold yellow <b>MA</b> brown <b>MT</b> brick red <b>NE</b> black <b>RB</b> burgundy <b>RS</b> red <b>VE</b> green	XX	E27 3 x Max 16W LED or 3 x Max 57W halo

CE IP20 +LED 220-240V<sub>AC</sub>

example composition code PL BEL090E27 BW XX

## PL BEL 118

kg 10 m<sup>3</sup> 0.98

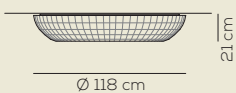

BELL / diffusore INCLUSO / diffuser INCLUDED

Type	Article	Colours	Finish	Source
PL	BEL 118 E27	<b>BC</b> white <b>BL</b> electric blue <b>BW</b> warm white <b>GI</b> gold yellow <b>MA</b> brown <b>MT</b> brick red <b>NE</b> black <b>RB</b> burgundy <b>RS</b> red <b>VE</b> green	XX	E27 4 x Max 16W LED or 4 x Max 57W halo

CE IP20 +LED 220-240V<sub>AC</sub>

example composition code PL BEL118E27 VE XX

# Bell

Manuel Vivian

Collezione composta da lampade da soffitto e lampade a sospensione con struttura metallica rivestita con fettuccia di tessuto ignifugato pongé superliscio. Disponibile in vari colori e dimensioni. Sorgente luminosa con attacco a vite o a LED integrato dimmerabile.

*Collection consisting of ceiling lamps and suspended lamps with a metal frame covered with strips of extra smooth flame-retardant pongé fabric. Available in several colours and sizes. Screw fitting or built-in dimmable LED light source.*

## PL BEL 180

kg 27 m<sup>3</sup> 2.64

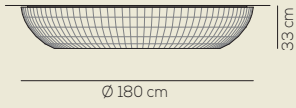

**BELL** / diffusore INCLUSO / diffuser INCLUDED

Type	Article	Colours	Finish	Source
PL	BEL 180 E27	<b>BC</b> white <b>BL</b> electric blue <b>BW</b> warm white <b>GI</b> gold yellow <b>MA</b> brown <b>MT</b> brick red <b>NE</b> black <b>RB</b> burgundy <b>RS</b> red <b>VE</b> green	XX	E27 5 x Max 16W LED or 5 x Max 46W halo

CE IP20 +LED 220-240V<sub>AC</sub>

example composition code PL BEL180E27 BW XX

# Bell

Manuel Vivian

Collezione composta da lampade da soffitto e lampade a sospensione con struttura metallica rivestita con fettucia di tessuto ignifugato pongé superliscio. Disponibile in vari colori e dimensioni. Sorgente luminosa con attacco a vite o a LED integrato dimmerabile.

*Collection consisting of ceiling lamps and suspended lamps with a metal frame covered with strips of extra smooth flame-retardant pongé fabric. Available in several colours and sizes. Screw fitting or built-in dimmable LED light source.*

## SP BEL 045

kg 5 m<sup>3</sup> 0.22

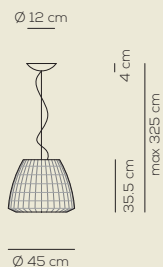

BELL / diffusore INCLUSO / diffuser INCLUDED

Type	Article	Colours	Finish	Source
SP	BEL 045 E27	<b>BC</b> white  <b>BL</b> electric blue  <b>BW</b> warm white  <b>GI</b> gold yellow  <b>MA</b> brown  <b>MT</b> brick red  <b>NE</b> black  <b>RB</b> burgundy  <b>RS</b> red  <b>VE</b> green	XX	E27 1 x Max 20W LED or 1 x Max 70W halo

CE IP20 +LED 220-240V<sub>AC</sub>

example composition code SP BEL045E27 GI XX

## SP BEL 060

kg 7.5 m<sup>3</sup> 0.43

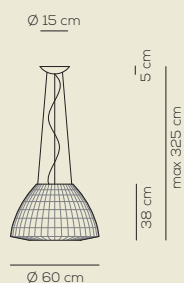

BELL / diffusore INCLUSO / diffuser INCLUDED

Type	Article	Colours	Finish	Source
SP	BEL 060 E27	<b>BC</b> white  <b>BL</b> electric blue  <b>BW</b> warm white  <b>GI</b> gold yellow  <b>MA</b> brown  <b>MT</b> brick red  <b>NE</b> black  <b>RB</b> burgundy  <b>RS</b> red  <b>VE</b> green	XX	E27 1 x Max 20W LED or 1 x Max 70W halo

CE IP20 +LED 220-240V<sub>AC</sub>

example composition code SP BEL060E27 BW XX

KITLIGHTEC2 diffusore opzionale - optional diffuser

# Bell

Manuel Vivian

Collezione composta da lampade da soffitto e lampade a sospensione con struttura metallica rivestita con fettucce di tessuto ignifugato pongé superliscio. Disponibile in vari colori e dimensioni. Sorgente luminosa con attacco a vite o a LED integrato dimmerabile.

Collection consisting of ceiling lamps and suspended lamps with a metal frame covered with strips of extra smooth flame-retardant pongé fabric. Available in several colours and sizes. Screw fitting or built-in dimmable LED light source.

## SP BEL 090

kg 13.5 m³ 1.06

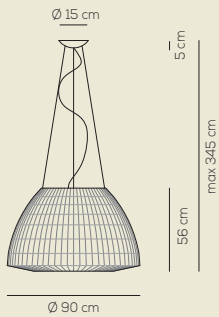

**BELL** / diffusore INCLUSO, con illuminazione verso alto e basso / *diffuser INCLUDED, with upward and downward lighting*

Type	Article	Colours	Finish	Source
SP	BEL 090 E27	<b>BC</b> white  <b>BL</b> electric blue  <b>BW</b> warm white  <b>GI</b> gold yellow  <b>MA</b> brown  <b>MT</b> brick red  <b>NE</b> black  <b>RB</b> burgundy  <b>RS</b> red  <b>VE</b> green	XX	E27 4 x Max 20W LED or 4 x Max 46W halo

CE IP20 +LED 220-240VAC

example composition code SP BEL090E27 BW XX

## SP BEL 090 LED

**BELL** / diffusore INCLUSO, con illuminazione verso alto e basso / *diffuser INCLUDED, with upward and downward lighting*

Type	Article	Colours	Finish	Source
SP	BEL 090 LED	<b>BC</b> white  <b>BL</b> electric blue  <b>BW</b> warm white  <b>GI</b> gold yellow  <b>MA</b> brown  <b>MT</b> brick red  <b>NE</b> black  <b>RB</b> burgundy  <b>RS</b> red  <b>VE</b> green	XX	LED 88W - diffused beam 3000K*, 4000K

CE IP20 CRI90 LED ~9610 lm\* 109 lm/W\* 110-240VAC

example composition code SP BEL090LED RS XX

# Bell

Manuel Vivian

Collezione composta da lampade da soffitto e lampade a sospensione con struttura metallica rivestita con fettucce di tessuto ignifugato pongé superliscio. Disponibile in vari colori e dimensioni. Sorgente luminosa con attacco a vite o a LED integrato dimmerabile.

Collection consisting of ceiling lamps and suspended lamps with a metal frame covered with strips of extra smooth flame-retardant pongé fabric. Available in several colours and sizes. Screw fitting or built-in dimmable LED light source.

## SP BEL 118

kg 16.5 m³ 1.9

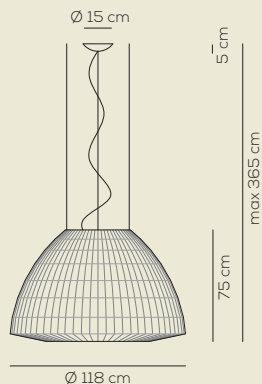

**BELL** / diffusore INCLUSO, con illuminazione verso alto e basso / *diffuser INCLUDED, with upward and downward lighting*

Type	Article	Colours	Finish	Source
SP	BEL 118 E27	<b>BC</b> white  <b>BL</b> electric blue  <b>BW</b> warm white  <b>GI</b> gold yellow  <b>MA</b> brown  <b>MT</b> brick red  <b>NE</b> black  <b>RB</b> burgundy  <b>RS</b> red  <b>VE</b> green	XX	E27 4 x Max 20W LED or 4 x Max 57W halo

CE IP20 +LED 220-240VAC

example composition code SP BEL118E27 VE XX

## SP BEL 118 LED

**BELL** / diffusore INCLUSO, con illuminazione verso alto e basso / *diffuser INCLUDED, with upward and downward lighting*

Type	Article	Colours	Finish	Source
SP	BEL 118 LED	<b>BC</b> white  <b>BL</b> electric blue  <b>BW</b> warm white  <b>GI</b> gold yellow  <b>MA</b> brown  <b>MT</b> brick red  <b>NE</b> black  <b>RB</b> burgundy  <b>RS</b> red  <b>VE</b> green	XX	LED 98W - diffused beam 3000K*, 4000K

CE IP20 CRI90 LED ~10719 lm\* 109 lm/W\* 110-240VAC

example composition code SP BEL118LED RS XX



# Bell

Manuel Vivian

Collezione composta da lampade da soffitto e lampade a sospensione con struttura metallica rivestita con fettucce di tessuto ignifugato pongé superliscio. Disponibile in vari colori e dimensioni. Sorgente luminosa con attacco a vite o a LED integrato dimmerabile.

Collection consisting of ceiling lamps and suspended lamps with a metal frame covered with strips of extra smooth flame-retardant pongé fabric. Available in several colours and sizes. Screw fitting or built-in dimmable LED light source.

## SP BEL 180

kg 39 m³ 5.7

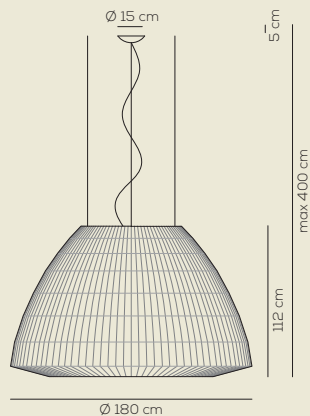

**BELL** / diffusore INCLUSO, con illuminazione verso alto e basso / *diffuser INCLUDED, with upward and downward lighting*

Type	Article	Colours	Finish	Source
SP	BEL 180 E27	<b>BC</b> white  <b>BL</b> electric blue  <b>BW</b> warm white  <b>GI</b> gold yellow  <b>MA</b> brown  <b>MT</b> brick red  <b>NE</b> black  <b>RB</b> burgundy  <b>RS</b> red  <b>VE</b> green	XX	<b>E27</b> 4 x Max 16W + 1 x Max 9,5W LED  or  4 x Max 57W + 1 x Max 46W halo

CE IP20 +LED 220-240VAc

example composition code SP BEL180E27 GI XX

## SP BEL 180 LED

**BELL** / diffusore INCLUSO, con illuminazione verso alto e basso / *diffuser INCLUDED, with upward and downward lighting*

Type	Article	Colours	Finish	Source
SP	BEL 180 LED	<b>BC</b> white  <b>BL</b> electric blue  <b>BW</b> warm white  <b>GI</b> gold yellow  <b>MA</b> brown  <b>MT</b> brick red  <b>NE</b> black  <b>RB</b> burgundy  <b>RS</b> red  <b>VE</b> green	XX	<b>LED</b> 98W - diffused beam 3000K*, 4000K

CE IP20 CRI90 LED ~10719 lm\* 109 lm/W\* 110-240VAc

example composition code SP BEL180LED MT XX

# Clavius

Manuel Vivian

Collezione composta da lampade da parete, lampade da soffitto, lampade a sospensione, lampade da tavolo e lampada da terra con montatura in metallo e paralume lavorato a mano con fili setati. Disponibile in vari colori e dimensioni. Sorgente luminosa con attacco a vite o LED integrato.

Collection consisting of wall lamps, ceiling lamps, suspended lamps, table lamps and floor lamp. Metal frame and hand-made silken thread lampshade. Available in several colours and sizes. Screw fitting light or built-in LED light source.

## COLOURS



white



tobacco



sand

## FINISHES



chrome canopy



gold canopy



chrome finish



gold finish

## AP CLAV BR

kg 1.5 m<sup>3</sup> 0.03

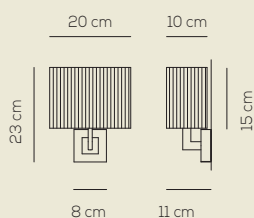

### CLAVIUS

Type	Article	Colours	Finish	Source
AP	CLAV BR	BC white	XX chrome	E14 1 x Max 6,5W LED or 1 x Max 42W halo
		TA tobacco	OR gold	
		SA sand		

CE IP20 ADA +LED 220-240V<sub>AC</sub>

example composition code AP CLAVBR SA OR E14

## AP CLAV 30

kg 2 m<sup>3</sup> 0.03

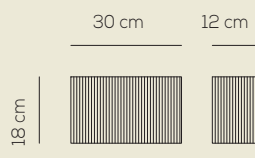

### CLAVIUS / diffusore INCLUSO / diffuser INCLUDED

Type	Article	Colours	Finish	Source
AP	CLAV 30	BC white	XX white	E14 1 x Max 6,5W LED or 1 x Max 42W halo
		TA tobacco		
		SA sand		

CE IP20 +LED 220-240V<sub>AC</sub>

example composition code AP CLAV30 TA XX E14

# Clavius

Manuel Vivian

Collezione composta da lampade da parete, lampade da soffitto, lampade a sospensione, lampade da tavolo e lampada da terra con montatura in metallo e paralume lavorato a mano con fili setati. Disponibile in vari colori e dimensioni. Sorgente luminosa con attacco a vite o LED integrato.

Collection consisting of wall lamps, ceiling lamps, suspended lamps, table lamps and floor lamp. Metal frame and hand-made silken thread lampshade. Available in several colours and sizes. Screw fitting light or built-in LED light source.

## PL CLAVIU

kg 3 m<sup>3</sup> 0.06

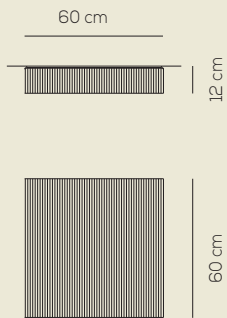

### CLAVIUS

Type	Article	Colours	Finish	Source
PL	CLAVIU	BC white  TA tobacco  SA sand	XX white	E27 3 x Max 9,5W LED or 3 x Max 46W halo



IP20 +LED 220-240V<sub>AC</sub>

example composition code PL CLAVIU BC XX E27

## SP CLAVIU E27

kg 5 m<sup>3</sup> 0.12

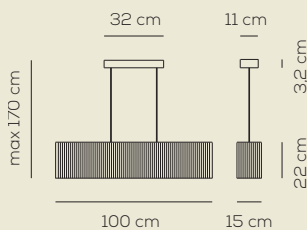

### CLAVIUS / diffusore NON INCLUSO / diffuser NOT INCLUDED

Type	Article	Colours	Finish	Source
SP	CLAVIU	BC white  TA tobacco  SA sand	CR chrome  OR gold	E27 3 x Max 16W LED or 3 x Max 70W halo



IP20 +LED 220-240V<sub>AC</sub>

example composition code SP CLAVIU SA OR E27

DSPCLAVIUSXXXXX diffusore optional / optional diffuser

## PT CLAVIU

kg 16 m<sup>3</sup> 0.24

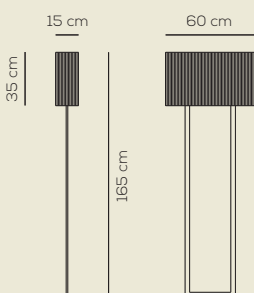

### CLAVIUS

Type	Article	Colours	Finish	Source
PT	CLAVIU	BC white  TA tobacco  SA sand	CR chrome  OR gold	E27 2 x Max 70W halo (dimnable lamps required)



IP20 +LED 220-240V<sub>AC</sub>

example composition code PT CLAVIU BC OR E27

# Clavius

Manuel Vivian

Collezione composta da lampade da parete, lampade da soffitto, lampade a sospensione, lampade da tavolo e lampada da terra con montatura in metallo e paralume lavorato a mano con fili setati. Disponibile in vari colori e dimensioni. Sorgente luminosa con attacco a vite o LED integrato.

Collection consisting of wall lamps, ceiling lamps, suspended lamps, table lamps and floor lamp. Metal frame and hand-made silken thread lampshade. Available in several colours and sizes. Screw fitting light or built-in LED light source.

## LT CLAV XP

kg 1 m<sup>3</sup> 0.03

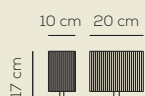

### CLAVIUS

Type	Article	Colours	Finish	Source
LT	CLAV XP	BC white TA tobacco SA sand	CR chrome OR gold	E14 1 x Max 6,5W LED or 1 x Max 42W halo

IP20 **+LED** 220-240V<sub>AC</sub>  
 example composition code LT CLAVXP BC OR E14

## LT CLAVI P

kg 4 m<sup>3</sup> 0.07

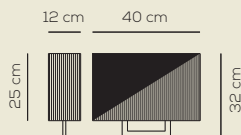

### CLAVIUS

Type	Article	Colours	Finish	Source
LT	CLAVI P	BC white TA tobacco SA sand	CR chrome OR gold	E14 2 x Max 6,5W LED or 2 x Max 42W halo

IP20 **+LED** 220-240V<sub>AC</sub>  
 example composition code LT CLAVIP SA CR E14

## LT CLAVI G

kg 8 m<sup>3</sup> 0.16

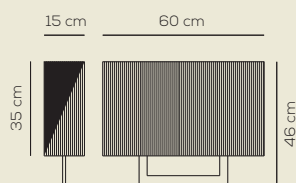

### CLAVIUS

Type	Article	Colours	Finish	Source
LT	CLAVI G	BC white TA tobacco SA sand	CR chrome OR gold	E27 2 x Max 16W LED or 2 x Max 70W halo

IP20 **+LED** 220-240V<sub>AC</sub>  
 example composition code LT CLAVIG SA OR E27

# Cloudy

Dima Loginoff

Lampade a sospensione con struttura metallica in alluminio e acciaio diffusori in materiale plastico con rivestimento in tessuto elastico removibile. Disponibile in colore bianco. Sorgente luminosa a LED integrato dimmerabile.

*Suspended lamp with steel and aluminum frame and diffusers in plastic material with elastic and removable fabric cover. Available in white colour. Built-in dimmable LED light source.*

COLOUR



white

## SP CLOUDY

kg 14 m<sup>3</sup> 0.700

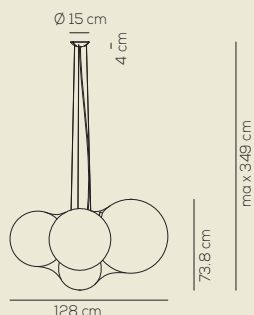
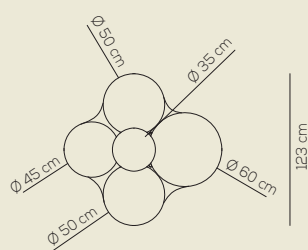

### CLOUDY / DRIVER INCLUDED

Type	Article	Colours	Finishings	Source
SP	CLOUDY	BC white	XX white	<b>LED</b> 92W - diffused beam 3000K*, 2700K



IP20

CRI>90



110-240V<sub>AC</sub>

**LED**

~7602 lm\*

~83 lm/W\*

example composition code SP CLOUDY BC XX LED

# Cut

Timo Ripatti

Collezione di lampade a sospensione, terra e tavolo con struttura metallica in alluminio e acciaio. Disponibile in colore nero. Corpo illuminante installabile in tre posizioni differenti. Sorgente luminosa a LED integrato dimmerabile.

Collection consisting of steel and aluminum suspended, floor and table lamps. Available in black colour. The Lighting source can be installed in three different positions. Built-in dimmable LED light source.

COLOUR



intense black

## SP CUT

kg 5,57 m<sup>3</sup> 0,133

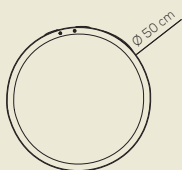
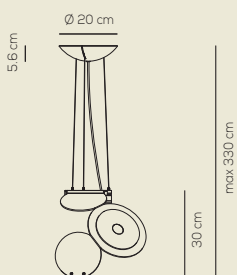

CUT / DRIVER INCLUDED

Type	Article	Colours	Finishings	Source
SP	CUT XXX	NE intense black	XX	LED 21W - optic ~ 60° beam 3000K

IP20 CRI>90 110-240V<sub>AC</sub> **LED** ~1665 lm ~80 lm/W

example composition code SP CUT XXX NE XX LED

## PT CUT

kg 15.5 m<sup>3</sup> 0,220

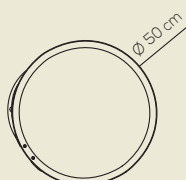
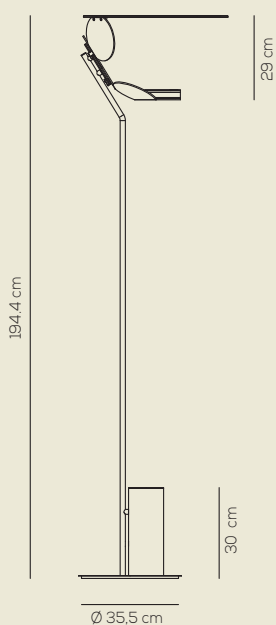

CUT / DIMMER INCLUDED

Type	Article	Colours	Finishings	Source
PT	CUT XXX	NE intense black	XX	<b>LED</b> 21W - optic ~ 60° beam 3000K

IP20 CRI>90 110-240V<sub>AC</sub> **LED** ~1665 lm ~80 lm/W

example composition code PT CUTXXX NE XX LED

# Cut

Timo Ripatti

Collezione di lampade a sospensione, terra e tavolo con struttura metallica in alluminio e acciaio. Disponibile in colore nero. Corpo illuminante installabile in tre posizioni differenti. Sorgente luminosa a LED integrato dimmerabile.

Collection consisting of steel and aluminum suspended, floor and table lamps. Available in black colour. The Lighting source can be installed in three different positions. Built-in dimmable LED light source.

## LT CUT

kg 4,75 m<sup>3</sup> 0,133

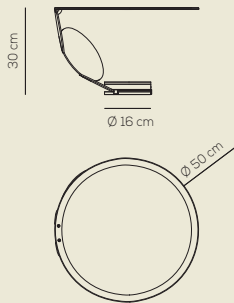

### CUT / DIMMER INCLUDED

Type	Article	Colours	Finishings	Source
LT	CUT XXX	NE intense black	XX	<b>LED</b> 17W - optic ~ 60° beam <b>3000K</b>

IP20 CRI>90 dimmable 110-240VAc **LED** ~1376 lm ~81 lm/W

example composition code LT CUT XXX NE XX LED

Altre 2 posizioni di montaggio del diffusore / Installation of the diffuser in 2 additional positions

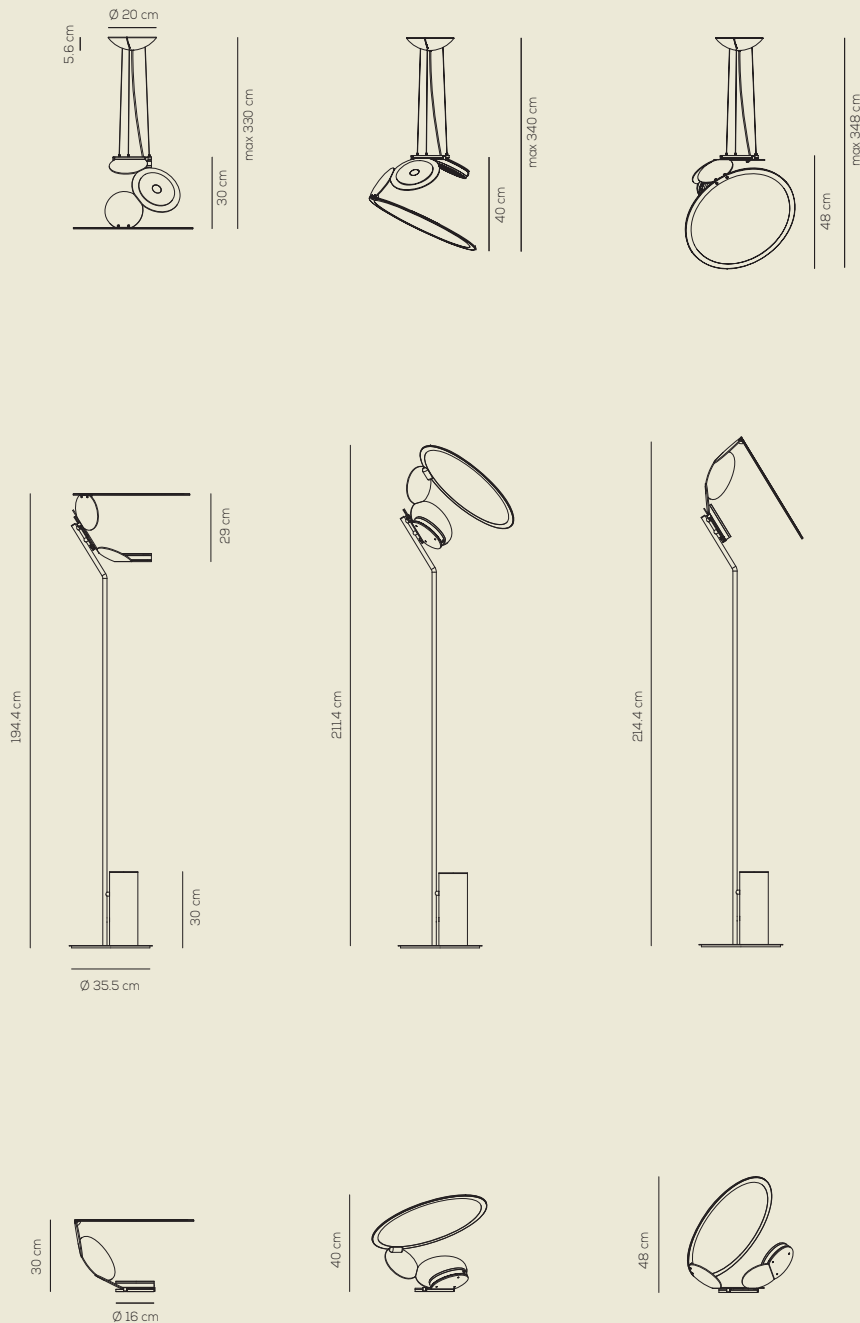

Lampada da soffitto o parete con struttura metallica in ottone naturale. Sorgente luminosa orientabile. LED integrato dimmerabile.

*Ceiling or wall lamp with metal and natural brass frame. The lighting source can be adjusted. Built-in dimmable LED light source.*

COLOUR



natural brass

**FA EGO**

kg 0,5 m³ 0,004

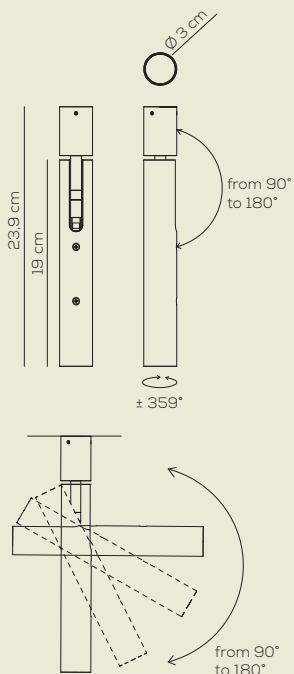

EGO

Type	Article	Colours	Finishings	Source
FA	EGO X 30	OT natural brass	XX	LED 1 x 8.8W - 250 mA 32.2Vdc diffused - <b>3000K</b>

IP20 CRI80 **LED** ~1220 lm ~139 lm/W  
 example composition code FA EGOX30 OT XX LED

optional for more info see page 307

CEDLTC00123 standard 250mA driver - Max 10W



CEDLTC00124 dimmable Phase Cut 250mA driver - Max 12W

CEDLTC00125 dimmable DALI 1-10V & PUSH 250mA driver - Max 28W

CEDLTC00126 dimmable DALI 250mA driver - Max 12W



# Fairy

Manuel Vivian

Collezione composta da faretti, lampade da parete, lampade da soffitto e lampade a sospensione con struttura in metallo e diffusore in cristallo. Disponibile in vari colori e dimensioni. Sorgente luminosa a LED integrato dimmerabile per alcuni articoli.

Collection consisting of recessed downlights, wall lamps, ceiling lamps and suspended lamps with metal frame and glass diffuser. Available in several colours and sizes. Built-in (dimmerable for some versions) LED light source.

## COLOURS



crystal



amber



grey



chrome finish

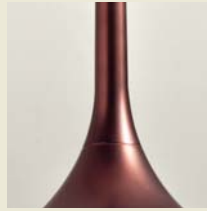

matt bronze



matt nickel



chromed recessed canopy



chrome canopy

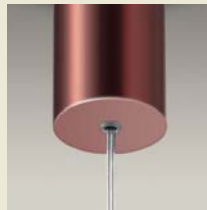

matt bronze canopy



matt nickel canopy



white canopy for 12 R, 12 AND 18 versions

## FA FAIRY

kg 1 m<sup>3</sup> 0.0014

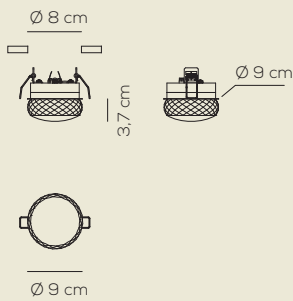

### FAIRY / DRIVER NOT INCLUDED

Type	Article	Colours	Finish	Source
FA	FAIRY X	CS crystal AM amber GR grey	CR chrome	LED 6,2W - 350mA diffused beam - 2700K

CE ~565 lm 91 lm/W

foro - hole Ø 8 cm / profondità min - min depth 10 cm - Collegare in serie. / Wire in series.

example composition code FA FAIRYX AM CR LED

optional for more info see page 308

	CEDLTC00100	standard 350mA driver - Max 8W
	CEDLTC00103	dimmmable 1-10V 350mA driver - Max 25W
	CEDLTC00104	dimmmable DALI 350mA driver - Max 25W

# Fairy

Manuel Vivian

Collezione composta da faretti, lampade da parete, lampade da soffitto e lampade a sospensione con struttura in metallo e diffusore in cristallo. Disponibile in vari colori e dimensioni. Sorgente luminosa a LED integrato dimmerabile per alcuni articoli.

Collection consisting of recessed downlights, wall lamps, ceiling lamps and suspended lamps with metal frame and glass diffuser. Available in several colours and sizes. Built-in (dimmmable for some versions) LED light source.

## AP FAIRY

kg 1.3 m<sup>3</sup> 0.0032

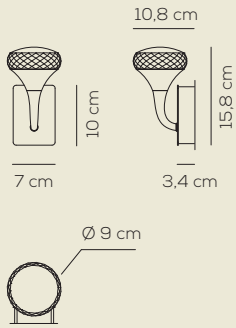

### FAIRY / DRIVER INCLUDED

Type	Article	Colours	Finish	Source
AP	FAIRY X	CS crystal AM amber GR grey	CR chrome	LED 7,4W - diffused beam 2700K

CE IP20 CRI90 LED ~565 lm 76 lm/W 100-240V<sub>AC</sub>

example composition code AP FAIRYX CS CR LED

## PL FAIRY

kg 1.3 m<sup>3</sup> 0.0048

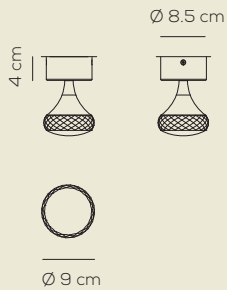

### FAIRY / DRIVER INCLUDED

Type	Article	Colours	Finish	Source
PL	FAIRY X	CS crystal AM amber GR grey	CR chrome	LED 7,4W - diffused beam 2700K

CE IP20 CRI90 LED ~565 lm 76 lm/W 100-240V<sub>AC</sub>

example composition code PL FAIRYX GR CR LED

## PL FAIRY I (RECESSED)

kg 1 m<sup>3</sup> 0.001

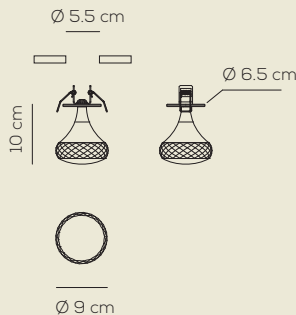

### FAIRY / DRIVER NOT INCLUDED

Type	Article	Colours	Finish	Source
PL	FAIRY I	CS crystal AM amber GR grey	CR chrome	LED 6,2W - 350mA diffused beam - 2700K

CE IP20 CRI90 LED ~565 lm 91 lm/W

foro - hole Ø 5,5 cm / profondità min - min depth 10 cm - Collegare in serie. / Wire in series.

example composition code PL FAIRYI GR CR LED

optional for more info see page 308

□	CEDLTC00100	standard 350mA driver - Max 8W
□	CEDLTC00103	dimmmable 1-10V 350mA driver - Max 25W
□	CEDLTC00104	dimmmable DALI 350mA driver - Max 25W

# Fairy

Manuel Vivian

Collezione composta da faretti, lampade da parete, lampade da soffitto e lampade a sospensione con struttura in metallo e diffusore in cristallo. Disponibile in vari colori e dimensioni. Sorgente luminosa a LED integrato dimmerabile per alcuni articoli.

Collection consisting of recessed downlights, wall lamps, ceiling lamps and suspended lamps with metal frame and glass diffuser. Available in several colours and sizes. Built-in (dimmmable for some versions) LED light source.

## SP FAIRY

kg 1.7 m<sup>3</sup> 0.015

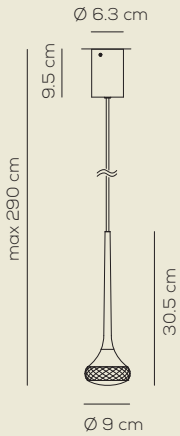

### FAIRY / DRIVER INCLUDED

Type	Article	Colours	Finish	Source
SP	FAIRY X	CS crystal	CR chrome	LED 7,4W diffused beam - 2700K
		AM amber	BR matt bronze	
		GR grey	NI matt nickel	

Gli articoli in rosso sono disponibili solo fino ad esaurimento scorte. Articles in red are available until sold out.

~565 lm 76 lm/W 100-240VAc  
 example composition code SP FAIRYX CS BR LED

## SP FAIRY I (RECESSED)

kg 1.2 m<sup>3</sup> 0.015

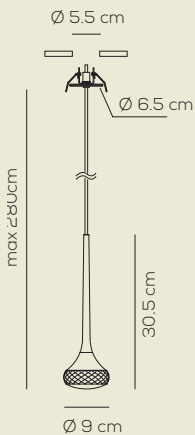

### FAIRY / DRIVER NOT INCLUDED

Type	Article	Colours	Finish	Source
SP	FAIRY I	CS crystal	CR chrome	LED 6,2W - 350mA diffused beam - 2700K
		AM amber	BR matt bronze	
		GR grey	NI matt nickel	

Gli articoli in rosso sono disponibili solo fino ad esaurimento scorte. Articles in red are available until sold out.

~565 lm 91 lm/W

foro - hole Ø 5,5 cm / profondità min - min depth 10 cm - Collegare in serie. / Wire in series.

example composition code SP FAIRYI AM NI LED

optional for more info see page 308

- CEDLTC00100 standard 350mA driver - Max 8W
- CEDLTC00103 dimmable 1-10V 350mA driver - Max 25W
- CEDLTC00104 dimmable DALI 350mA driver - Max 25W

## SP FAI 12 R

kg 14.5 m<sup>3</sup> 0.16

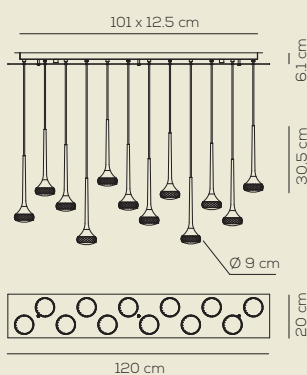

### FAIRY / DRIVER INCLUDED

Type	Article	Colours	Finish	Source
SP	FAI 12 R	CS crystal	CR white + chrome	LED 12 x 6,4W diffused beam - 2700K
		AM amber	BR matt bronze	
		GR grey	NI matt nickel	

Gli articoli in rosso sono disponibili solo fino ad esaurimento scorte. Articles in red are available until sold out.

12 x ~565 lm 88 lm/W 110-240VAc  
 example composition code SP FAI12R GR BR LED

# Fairy

Manuel Vivian

Collezione composta da faretti, lampade da parete, lampade da soffitto e lampade a sospensione con struttura in metallo e diffusore in cristallo. Disponibile in vari colori e dimensioni. Sorgente luminosa a LED integrato dimmerabile per alcuni articoli.

Collection consisting of recessed downlights, wall lamps, ceiling lamps and suspended lamps with metal frame and glass diffuser. Available in several colours and sizes. Built-in (dimmmable for some versions) LED light source.

## SP FAIR 12

kg 14.5 m<sup>3</sup> 0.17

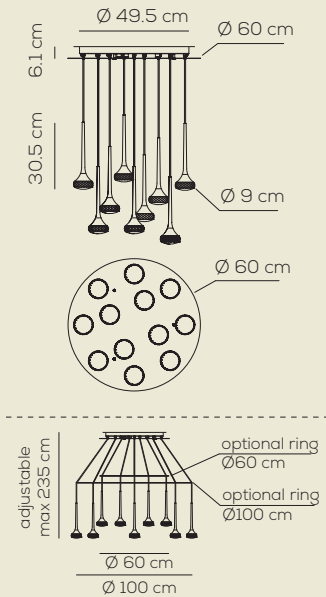

### FAIRY / DRIVER INCLUDED

Type	Article	Colours	Finish	Source
SP	FAIR 12	CS crystal	CR white + chrome	LED 12 x 6,4W diffused beam - 2700K
		AM amber	BR white + matt bronze	
		GR grey	NI white + matt nickel	

Gli articoli in rosso sono disponibili solo fino ad esaurimento scorte. Articles in red are available until sold out.

12 x ~565 lm 88 lm/W 110-240VAc  
 example composition code SP FAIR12 CS NI LED

optional accessories:

ANELLOFAIRY060X kg 1.2 - m<sup>3</sup> 0.034 - Ø 60 cm  
 Anello per composizione personalizzata. Elementi di bloccaggio inclusi.  
 Ring for customised composition. Fastening elements included.

ANELLOFAIRY100X kg 2 - m<sup>3</sup> 0.093 - Ø 100 cm  
 Anello per composizione personalizzata. Elementi di bloccaggio inclusi.  
 Ring for customised composition. Fastening elements included.

Suggerito l'uso di entrambi gli anelli da Ø 60 e Ø 100 cm per la creazione di composizioni personalizzate. We suggest the use of both the Ø 60 e Ø 100 cm rings together when creating customised compositions.

## SP FAIR 18

kg 20.1 m<sup>3</sup> 0.28

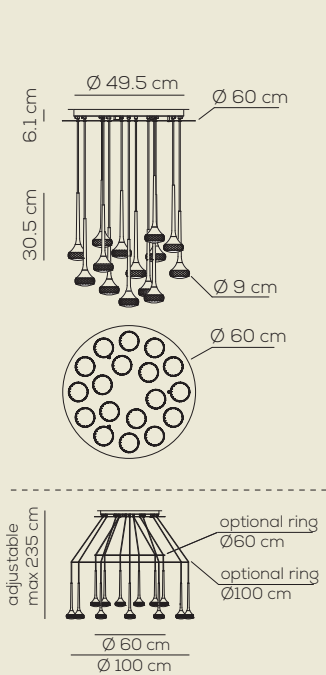

### FAIRY / DRIVER INCLUDED

Type	Article	Colours	Finish	Source
SP	FAIR 18	CS crystal	CR white + chrome	LED 18 x 6,4W diffused beam - 2700K
		AM amber	BR white + matt bronze	
		GR grey	NI white + matt nickel	

Gli articoli in rosso sono disponibili solo fino ad esaurimento scorte. Articles in red are available until sold out.

18 x ~565 lm 88 lm/W 110-240VAc  
 example composition code SP FAIR18 CS CR LED

optional accessories:

ANELLOFAIRY060X kg 1.2 - m<sup>3</sup> 0.034 - Ø 60 cm  
 Anello per composizione personalizzata. Elementi di bloccaggio inclusi.  
 Ring for customised composition. Fastening elements included.

ANELLOFAIRY100X kg 2 - m<sup>3</sup> 0.093 - Ø 100 cm  
 Anello per composizione personalizzata. Elementi di bloccaggio inclusi.  
 Ring for customised composition. Fastening elements included.

Suggerito l'uso di entrambi gli anelli da Ø 60 e Ø 100 cm per la creazione di composizioni personalizzate. We suggest the use of both the Ø 60 e Ø 100 cm rings together when creating customised compositions.

# Favilla

Manuel Vivian

Lampada da parete o da soffitto in alluminio in due colori, orientabile. Disponibile anche nella versione ad incasso. Sorgente luminosa a LED integrato.

Adjustable wall or ceiling lamp in aluminium, also in a recessed version. Available in two colours. Built-in LED light source.

## COLOURS



black



white

## WALL/CEILING/ SPOT

kg 0.58 m<sup>3</sup> 0.0025

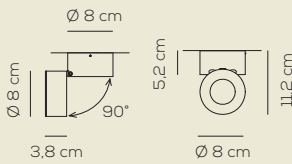

### FAVILLA / LED 7,4W / DRIVER INCLUDED

Zone	Type	Article	System compatibility	Finish	LED colour temperature	Beam options
E	6	105	0	<b>04</b> matt black  <b>07</b> white 9016 matt	<b>1</b> 2700 K	<b>1</b> 22°  <b>3</b> 45°

Gli articoli in rosso sono disponibili solo fino ad esaurimento scorte. Articles in red are available until sold out.

CE IP20 CRI90 100-240VAC **LED** ~565 lm 76 lm/W 100-240VAC

example composition code E 6 105 0 04 1 3

### FAVILLA / LED 8,4W / DRIVER INCLUDED

Zone	Type	Article	System compatibility	Finish	LED colour temperature	Beam options
E	6	105	0	<b>04</b> matt black  <b>07</b> white 9016 matt	<b>3</b> 4000 K	<b>1</b> 22°  <b>3</b> 45°

Gli articoli in rosso sono disponibili solo fino ad esaurimento scorte. Articles in red are available until sold out.

CE IP20 CRI80 100-240VAC **LED** ~620 lm 74 lm/W 100-240VAC

example composition code E 6 105 0 07 3 1

## RECESSED

kg 0.4 m<sup>3</sup> 0.0023

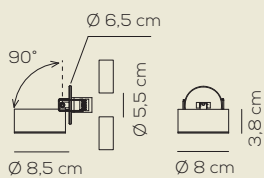

### FAVILLA / LED 6,2W - 350mA / DRIVER NOT INCLUDED

Zone	Type	Article	System compatibility	Finish	LED colour temperature	Beam options
E	8	105	<b>4</b> recessed	<b>04</b> matt black  <b>07</b> white 9016 matt	<b>1</b> 2700 K	<b>1</b> 22°  <b>3</b> 45°

CE IP20 **ADA** CRI90 **LED** ~565 lm 91 lm/W

foro - hole Ø 5,5 cm / profondità min - min depth 10 cm

Collegare in serie. Lunghezza cavo 150 cm. / Wire in series. Cable length 150 cm.

example composition code E 8 105 4 07 1 3

Gli articoli in rosso sono disponibili solo fino ad esaurimento scorte. Articles in red are available until sold out.

optional for more info see page 308

- CEDLTC00100 standard 350mA driver - Max 8W
- CEDLTC00103 dimmable 1-10V 350mA driver - Max 25W
- CEDLTC00104 dimmable DALI 350mA driver - Max 25W

# Fedora

Dima Loginoff

Collezione composta da faretto ad incasso e lampade a sospensione. Disponibile in vari colori e dimensioni. Sorgente luminosa LED con attacco GU10.

Collection consisting of recessed downlight and suspended lamps. Available in several colours and sizes. LED light source with GU10 fitting.

## COLOURS



rose gold



bronze



chrome



white canopies

## FA FEDORA

kg 0.4 m<sup>3</sup> 0.01

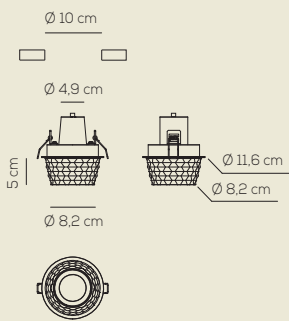

### FEDORA

Type	Article	Colours	Finish	Source
FA	FEDORA	XX glass	XX white varnished metal	GU1 GU10 LED 1 x Max 5,5W <b>only</b> LED bulbs

CE IP20 LED 220-240V<sub>AC</sub>

foro - hole Ø 10 cm / profondità min - min depth 11 cm

example composition code FA FEDORA XX XX GU1

LAMPGU105,5W040 optional GU10 LED bulb 5,5W - 3000K - 40° angle - see page 306

## SP FEDOR 1

kg 1.21 m<sup>3</sup> 0.04

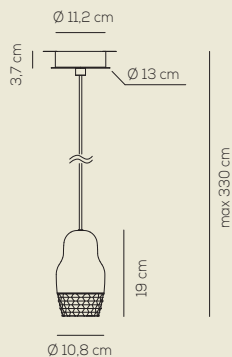

### FEDORA

Type	Article	Colours	Finish	Source
SP	FEDOR 1	RO rose gold + glass BR bronze + glass CR chrome + glass	BC white varnished metal	GU1 GU10 LED 1 x Max 5,5W <b>only</b> LED bulbs

CE IP20 LED 220-240V<sub>AC</sub>

example composition code SP FEDOR1 CR BC GU1

LAMPGU105,5W040 optional GU10 LED bulb 5,5W - 3000K - 40° angle - see page 306

## SP FEDOR 3

kg 4.56 m<sup>3</sup> 0.06

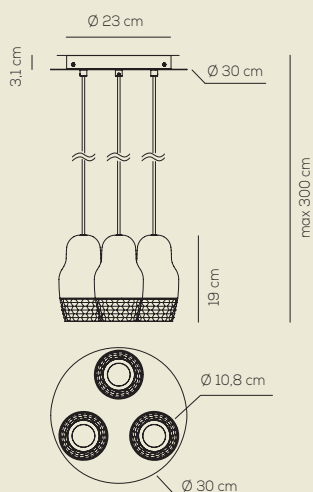

### FEDORA

Type	Article	Colours	Finish	Source
SP	FEDOR 3	RO rose gold + glass BR bronze + glass CR chrome + glass	BC white varnished metal	GU1 GU10 LED 3 x Max 5,5W <b>only</b> LED bulbs

CE IP20 LED 220-240V<sub>AC</sub>

example composition code SP FEDOR3 RO BC GU1

LAMPGU105,5W040 optional GU10 LED bulb 5,5W - 3000K - 40° angle - see page 306

# Fedora

Dima Loginoff

Collezione composta da faretto ad incasso e lampade a sospensione. Disponibile in vari colori e dimensioni. Sorgente luminosa LED con attacco GU10.

Collection consisting of recessed downlight and suspended lamps. Available in several colours and sizes. LED light source with GU10 fitting.

## SP FEDOR 6

kg 9.12 m<sup>3</sup> 0.24

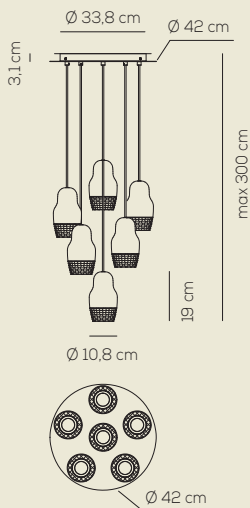

### FEDORA

Type	Article	Colours	Finish	Source
SP	FEDOR 6	RO rose gold + glass BR bronze + glass CR chrome + glass	BC white varnished metal	GU1 GU10 LED 6 x Max 5,5W only LED bulbs

CE IP20 LED 220-240V<sub>AC</sub>

example composition code SP FEDOR6 BR BC GU1

LAMPGU105,5W040 optional GU10 LED bulb 5,5W - 3000K - 40° angle - see page 306

## SP FEDOR 7

kg 11 m<sup>3</sup> 0.25

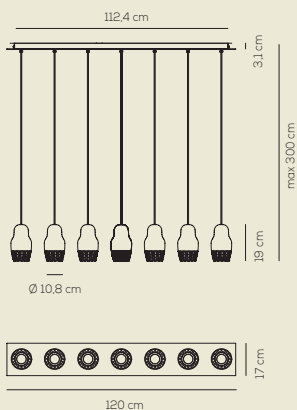

### FEDORA

Type	Article	Colours	Finish	Source
SP	FEDOR 7	RO rose gold + glass BR bronze + glass CR chrome + glass	BC white varnished metal	GU1 GU10 LED 7 x Max 5,5W only LED bulbs

CE IP20 LED 220-240V<sub>AC</sub>

example composition code SP FEDOR7 RO BC GU1

LAMPGU105,5W040 optional GU10 LED bulb 5,5W - 3000K - 40° angle - see page 306

## SP FEDO 12

kg 17.95 m<sup>3</sup> 0.41

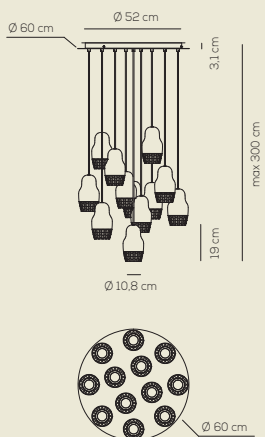

### FEDORA

Type	Article	Colours	Finish	Source
SP	FEDO 12	RO rose gold + glass BR bronze + glass CR chrome + glass	BC white varnished metal	GU1 GU10 LED 12 x Max 5,5W only LED bulbs

CE IP20 LED 220-240V<sub>AC</sub>

example composition code SP FEDO12 CR BC GU1

LAMPGU105,5W040 optional GU10 LED bulb 5,5W - 3000K - 40° angle - see page 306

# Framework

Manuel Vivian

Collezione composta da lampade da soffitto parete e sospensioni in alluminio bianco. Disponibile in varie dimensioni. Le lampade da soffitto/da parete sono fornite in tre diverse altezze. Sorgente luminosa a LED integrato dimmerabile.

Collection consisting of ceiling or wall lamps and suspended lamps in white aluminium. Available in several sizes. The ceiling/wall lamps are also supplied in three different heights. Built-in LED light source.

## COLOURS



white



canopy



diffuser detail

### PL FW P 090

kg 6.1 m<sup>3</sup> 0.20

### PL FW P 180

kg 6.2 m<sup>3</sup> 0.20

### PL FW P 270

kg 6.3 m<sup>3</sup> 0.20

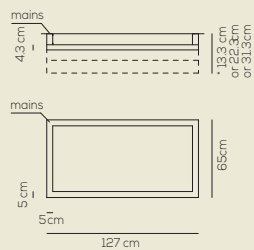

**FRAMEWORK** / DRIVER INCLUDED / applicazione a soffitto o a parete / application: both as ceiling or wall lamp

Type	Article	Colours	Code End	Source
PL	FW P 090 LED	BC white	XX	LED 70W - diffused beam 3000K*, 4000K
	FW P 180 LED			
	FW P 270 LED			

Gli articoli in rosso sono disponibili solo fino ad esaurimento scorte. Articles in red are available until sold out.

~9920 lm\* 142 lm/W\* 110-240VAc  
 example composition code PL FWP180LED BC XX

### PL FW M 090

kg 9.2 m<sup>3</sup> 0.37

### PL FW M 180

kg 9.3 m<sup>3</sup> 0.37

### PL FW M 270

kg 9.4 m<sup>3</sup> 0.37

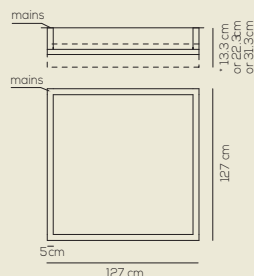

**FRAMEWORK** / DRIVER INCLUDED / applicazione a soffitto o a parete / application: both as ceiling or wall lamp

Type	Article	Colours	Code End	Source
PL	FW M 090 LED	BC white	XX	LED 70W - diffused beam 3000K*, 4000K
	FW M 180 LED			
	FW M 270 LED			

Gli articoli in rosso sono disponibili solo fino ad esaurimento scorte. Articles in red are available until sold out.

~9920 lm\* 142 lm/W\* 110-240VAc  
 example composition code PL FWM090LED BC XX

### PL FW G 090

kg 8.8 m<sup>3</sup> 0.38

### PL FW G 180

kg 8.9 m<sup>3</sup> 0.38

### PL FW G 270

kg 9 m<sup>3</sup> 0.38

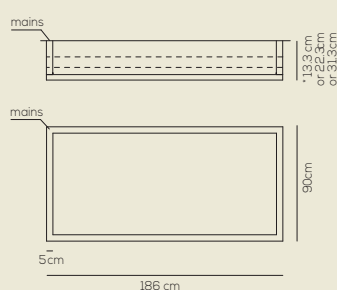

**FRAMEWORK** / DRIVER INCLUDED / applicazione a soffitto o a parete / application: both as ceiling or wall lamp

Type	Article	Colours	Code End	Source
PL	FW G 090 LED	BC white	XX	LED 105W - diffused beam 3000K*, 4000K
	FW G 180 LED			
	FW G 270 LED			

Gli articoli in rosso sono disponibili solo fino ad esaurimento scorte. Articles in red are available until sold out.

~14880 lm\* 142 lm/W\* 110-240VAc  
 example composition code PL FWG270LED BC XX



# Framework

Manuel Vivian

Collezione composta da lampade da soffitto parete e sospensioni in alluminio bianco. Disponibile in varie dimensioni. Le lampade da soffitto/da parete sono fornite in tre diverse altezze. Sorgente luminosa a LED integrato dimmerabile.

Collection consisting of ceiling or wall lamps and suspended lamps in white aluminium. Available in several sizes. The ceiling/wall lamps are also supplied in three different heights. Built-in LED light source.

## SP FRAME P

kg 5.6 m<sup>3</sup> 0.22

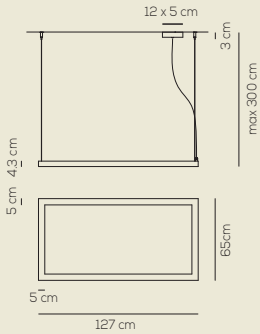

FRAMEWORK / DRIVER INCLUDED / con illuminazione verso l'alto / with upward lighting

Type	Article	Colours	Code End	Source
SP	FRAME P LED	BC white	XX	LED 70W - diffused beam 3000K*, 4000K

Gli articoli in rosso sono disponibili solo fino ad esaurimento scorte. Articles in red are available until sold out

~9920 lm\* 142 lm/W\* 110-240VAc  
 example composition code SP FRAMEPLED BC XX

## SP FRAME M

kg 7.5 m<sup>3</sup> 0.39

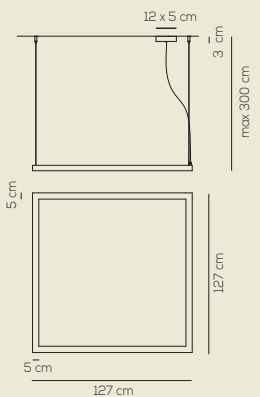

FRAMEWORK / DRIVER INCLUDED / con illuminazione verso l'alto / with upward lighting

Type	Article	Colours	Code End	Source
SP	FRAME M LED	BC white	XX	LED 70W - diffused beam 3000K*, 4000K

Gli articoli in rosso sono disponibili solo fino ad esaurimento scorte. Articles in red are available until sold out

~9920 lm\* 142 lm/W\* 110-240VAc  
 example composition code SP FRAMEMLED BC XX

## SP FRAME G

kg 8.2 m<sup>3</sup> 0.41

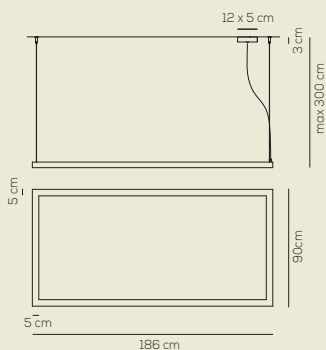

FRAMEWORK / DRIVER INCLUDED / con illuminazione verso l'alto / with upward lighting

Type	Article	Colours	Code End	Source
SP	FRAME G LED	BC white	XX	LED 105W - diffused beam 3000K*, 4000K

Gli articoli in rosso sono disponibili solo fino ad esaurimento scorte. Articles in red are available until sold out

~14880 lm\* 142 lm/W\* 110-240VAc  
 example composition code SP FRAMEGLED BC XX

# Hoops

Giovanni Barbato

Collezione composta da lampade da soffitto e lampade a sospensione con elementi intercambiabili di diverse forme e dimensioni. Finitura dorata o nera. Sorgente luminosa a LED integrato dimmerabile. Le lampade a sospensione prevedono un'illuminazione uplight e downlight.

Collection consisting of ceiling lamps and suspended lamps with interchangeable elements in different shapes and sizes. Gold or black finish. Built-in dimmable LED light source. The suspended lamps can light upward and downward.

## COLOURS



gold



gold canopy

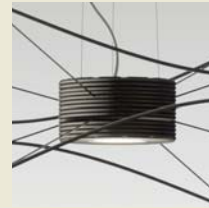

black



black canopy

## PL HOOPS 2

kg 3.7 m<sup>3</sup> 0.43

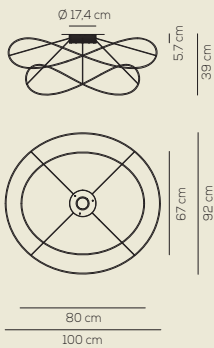

### HOOPS

Type	Article	Colours / Finish	Source
PL	HOOPS 2	OR gold / OR gold  NE black / NE black	LED 17W - diffused beam 3000K  other CCT options available upon request.

CE IP20 CRI90 220-240VAC **LED** ~1330 lm 78 lm/W

example composition code PL HOOPS2 NE NE LED

## PL HOOPS 3

kg 4 m<sup>3</sup> 0.43

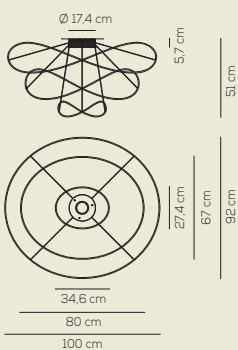

### HOOPS

Type	Article	Colours / Finish	Source
PL	HOOPS 3	OR gold / OR gold  NE black / NE black	LED 17W - diffused beam 3000K  other CCT options available upon request.

CE IP20 CRI90 220-240VAC **LED** ~1330 lm 78 lm/W

example composition code PL HOOPS3 OR OR LED

## SP HOOPS 2

kg 5.7 m<sup>3</sup> 0.43

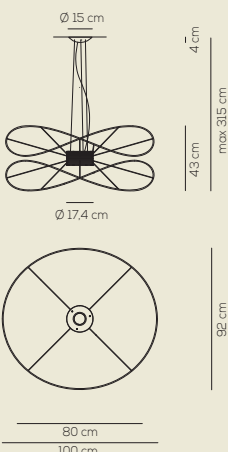

### HOOPS / con illuminazione verso alto e basso / with upward and downward lighting

Type	Article	Colours / Finish	Source
SP	HOOPS 2	OR gold / OR gold  NE black / NE black	LED 34W - diffused beam 3000K  other CCT options available upon request.

CE IP20 CRI90 220-240VAC **LED** ~2660 lm 78 lm/W

example composition code SP HOOPS2 OR OR LED

# Hoops

Giovanni Barbato

Collezione composta da lampade da soffitto e lampade a sospensione con elementi intercambiabili di diverse forme e dimensioni. Finitura dorata o nera. Sorgente luminosa a LED integrato dimmerabile. Le lampade a sospensione prevedono un'illuminazione uplight e downlight.

Collection consisting of ceiling lamps and suspended lamps with interchangeable elements in different shapes and sizes. Gold or black finish. Built-in dimmable LED light source. The suspended lamps can light upward and downward.

## SP HOOPS 3

kg 5.8 m<sup>3</sup> 0.43

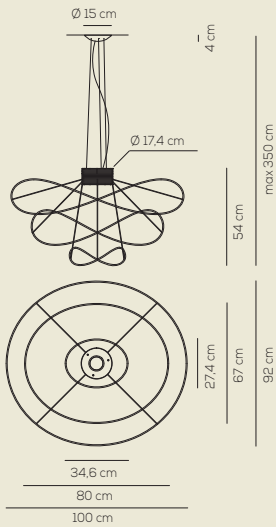

HOOPS / con illuminazione verso alto e basso / with upward and downward lighting

Type	Article	Colours / Finish	Source
SP	HOOPS 3	OR gold / OR gold  NE black / NE black	LED 34W - diffused beam 3000K  other CCT options available upon request.

220-240VAC **LED** ~2660 lm 78 lm/W  
 example composition code SP HOOPS3 OR OR LED

## SP HOOPS 4

kg 7.1 m<sup>3</sup> 0.43

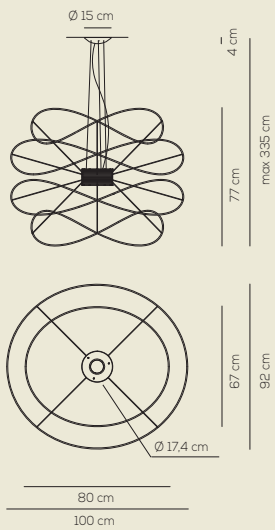

HOOPS / con illuminazione verso alto e basso / with upward and downward lighting

Type	Article	Colours / Finish	Source
SP	HOOPS 4	OR gold / OR gold  NE black / NE black	LED 34W - diffused beam 3000K  other CCT options available upon request.

220-240VAC **LED** ~2660 lm 78 lm/W  
 example composition code SP HOOPS4 OR OR LED

## SP HOOPS 6

kg 7.7 m<sup>3</sup> 0.43

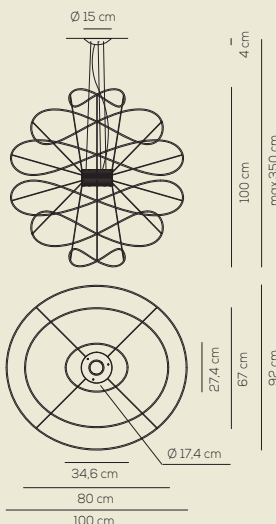

HOOPS / con illuminazione verso alto e basso / with upward and downward lighting

Type	Article	Colours / Finish	Source
SP	HOOPS 6	OR gold / OR gold  NE black / NE black	LED 34W - diffused beam 3000K  other CCT options available upon request.

220-240VAC **LED** ~2660 lm 78 lm/W  
 example composition code SP HOOPS6 OR OR LED

# Jewel

Yonoh

Collezione di lampade a sospensione in alluminio con arco in nylon caricato a vetro riciclato. Disponibile in colore nero e quattro versioni. La sorgente luminosa è a LED integrato dimmerabile o non dimmerabile.

Collection of aluminum suspended lamps with glass filled nylon arch made with recycled materials. Available in four pre-defined configurations in black color. Built-in dimmable or not dimmable LED light source.

COLOUR



black



produced with recycled material

## SP JEWE / JEWD 01

kg 0,9 m<sup>3</sup> 0,039

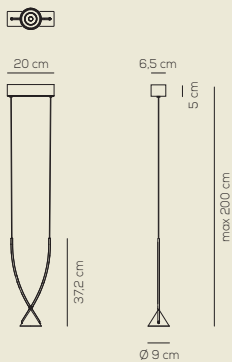

JEWEL / DRIVER INCLUDED NOT DIMMABLE

Type	Article	Colours / Finish	Source
SP	JEWE 01	NE black / NE black	LED 9W - optic ~ 35° beam 3000K*, 2700K not dimmable

CE IP20 CRI>90 LED ~671 lm\* 75 lm/W\* 220-240VAc

example composition code SP JEWE 01 NE NE LED

JEWEL / DRIVER INCLUDED DIMMABLE

Type	Article	Colours / Finish	Source
SP	JEWD 01	NE black / NE black	LED 9W - optic ~ 35° beam 3000K*, 2700K dimmable

CE IP20 CRI>90 dimmable 0/1-10V LED ~671 lm\* 75 lm/W\* 220-240VAc

example composition code SP JEWD 01 NE NE LED

## SP JEWE / JEWD 03

kg 3,5 m<sup>3</sup> 0,0208

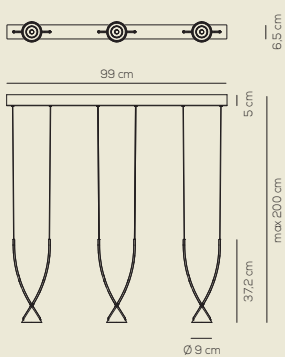

JEWEL / DRIVER INCLUDED NOT DIMMABLE

Type	Article	Colours / Finish	Source
SP	JEWE 03	NE black / NE black	LED 3 x 9W - optic ~ 35° beam 3000K*, 2700K not dimmable

CE IP20 CRI>90 LED ~2013 lm\* 77 lm/W\* 220-240VAc

example composition code SP JEWE 03 NE NE LED

JEWEL / DRIVER INCLUDED DIMMABLE

Type	Article	Colours / Finish	Source
SP	JEWD 03	NE black / NE black	LED 3 x 9W - optic ~ 35° beam 3000K*, 2700K dimmable

CE IP20 CRI>90 dimmable 0/1-10V LED ~2013 lm\* 77 lm/W\* 220-240VAc

example composition code SP JEWD 03 NE NE LED

# Jewel

Yonoh

Collezione di lampade a sospensione in alluminio con arco in nylon caricato a vetro riciclato. Disponibile in colore nero e quattro versioni. La sorgente luminosa è a LED integrato dimmerabile o non dimmerabile.

Collection of aluminum suspended lamps with glass filled nylon arch made with recycled materials. Available in four pre-defined configurations in black color. Built-in dimmable or not dimmable LED light source.

## SP JEWE / JEWD 04

kg 8,7 m<sup>3</sup> 0,065

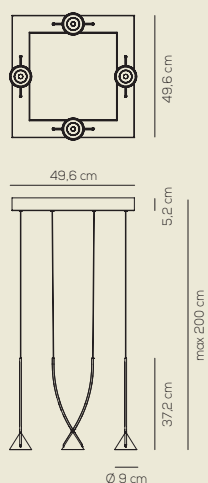

### JEWEL / DRIVER INCLUDED NOT DIMMABLE

Type	Article	Colours / Finish	Source
SP	JEWE 04	NE black / NE black	<b>LED</b> 4 x 9W - optic ~ 35° beam 3000K*, 2700K not dimmable

CE IP20 CRI>90 **LED** ~2684 lm\* 77 lm/W\* 220-240V<sub>AC</sub>

example composition code SP JEWE 04 NE NE LED

### JEWEL / DRIVER INCLUDED DIMMABLE

Type	Article	Colours / Finish	Source
SP	JEWD 04	NE black / NE black	<b>LED</b> 4 x 9W - optic ~ 35° beam 3000K*, 2700K dimmable

CE IP20 CRI>90  **LED** ~2684 lm\* 77 lm/W\* 220-240V<sub>AC</sub>

example composition code SP JEWD 04 NE NE LED

## SP JEWD 10

kg 8,7 m<sup>3</sup> 0,201

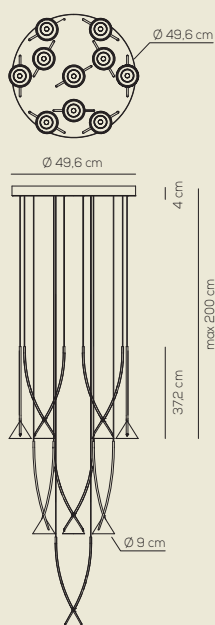

### JEWEL / DRIVER INCLUDED DIMMABLE

Type	Article	Colours / Finish	Source
SP	JEWD 10	NE black / NE black	<b>LED</b> 10 x 7.2W - optic ~ 35° beam 3000K*, 2700K dimmable

CE IP20 CRI>90  **LED** ~6710 lm\* 93 lm/W\* 220-240V<sub>AC</sub>

example composition code SP JEWD 10 NE NE LED

# Kwic

S. & R. Cornelissen

Collezione di lampade a soffitto/parete, sospensione e terra con struttura metallica in alluminio e acciaio. Diffusore in vetro soffiato opalino. Disponibile in due colori e due dimensioni. Sorgente luminosa a LED integrato dimmerabile.

Collection consisting of steel and aluminum ceiling/wall lamps, suspended and floor lamps with opaline blown glass diffuser. Available in two colours and two sizes. Built-in dimmable LED light source.

## COLOURS



intense black



transparent bronze

## PL KWIC 36

kg 1.9 m<sup>3</sup> 0,065

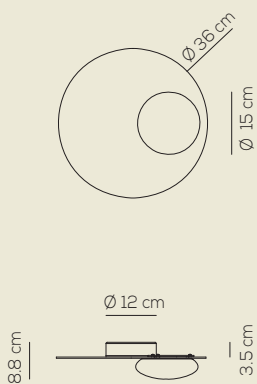

**KWIC / DRIVER INCLUDED / applicazione a soffitto o parete / application: both as ceiling or wall lamp**

Type	Article	Colours	Finishings	Source
PL	KWIC 36	NE intense black BR transparent bronze	XX	<b>LED</b> 18W - diffused beam 3000K*, 2700K

IP20 CRI>90 dimmable 0/1-10V 110-240VAc **LED** ~2151 lm\* ~119 lm/W\*

example composition code PL KWIC 36 XX XX LED

## PL KWIC 48

kg 2.25 m<sup>3</sup> 0,074

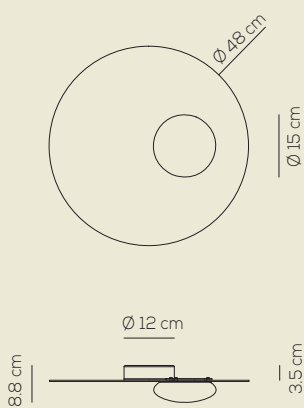

**KWIC / DRIVER INCLUDED / applicazione a soffitto o parete / application: both as ceiling or wall lamp**

Type	Article	Colours	Finishings	Source
PL	KWIC 48	NE intense black BR transparent bronze	XX	<b>LED</b> 18W - diffused beam 3000K*, 2700K

IP20 CRI>90 dimmable 0/1-10V 110-240VAc **LED** ~2151 lm\* ~119 lm/W\*

example composition code PL KWIC 48 XX XX LED

# Kwic

S. & R. Cornelissen

Collezione di lampade a soffitto/parete, sospensione e terra con struttura metallica in alluminio e acciaio. Diffusore in vetro soffiato opalino. Disponibile in due colori e due dimensioni. Sorgente luminosa a LED integrato dimmerabile.

Collection consisting of steel and aluminum ceiling/wall lamps, suspended and floor lamps with opaline blown glass diffuser. Available in two colours and two sizes. Built-in dimmable LED light source.

## SP KWIC 36

kg 2.25 m<sup>3</sup> 0,065

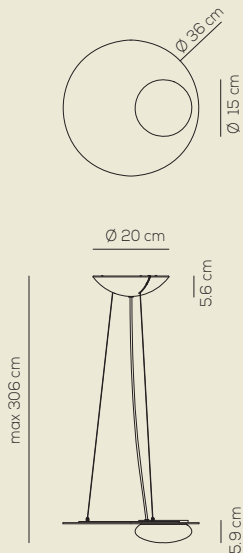

### KWIC / DRIVER INCLUDED

Type	Article	Colours	Finishings	Source
SP	KWIC 36	NE intense black BR transparent bronze	XX	LED 18W - diffused beam 3000K*, 2700K

CE IP20 CRI>90 110-240VAC **LED** ~2151 lm\* ~119 lm/W\*

example composition code SP KWIC 36 XX XX LED

## SP KWIC 48

kg 3.2 m<sup>3</sup> 0,074

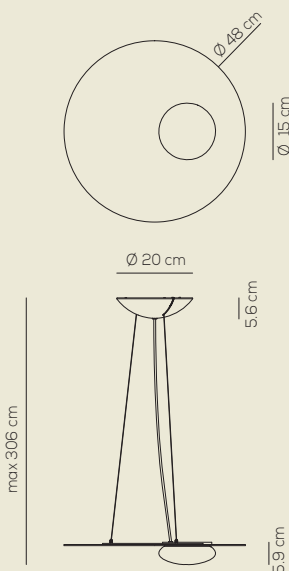

### KWIC / DRIVER INCLUDED

Type	Article	Colours	Finishings	Source
SP	KWIC 48	NE intense black BR transparent bronze	XX	LED 18W - diffused beam 3000K*, 2700K

CE IP20 CRI>90 110-240VAC **LED** ~2151 lm\* ~119 lm/W\*

example composition code SP KWIC 48 XX XX LED

## PT KWIC 36

kg 10,1 m<sup>3</sup> 0,126

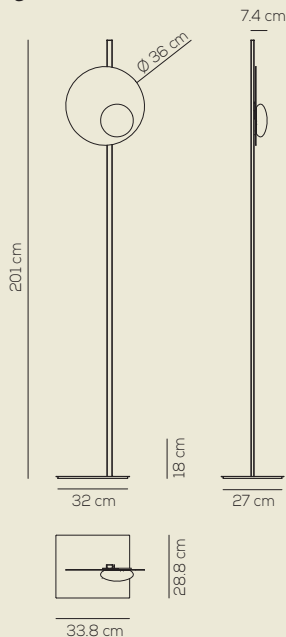

### KWIC / DIMMER INCLUDED

Type	Article	Colours	Finishings	Source
PT	KWIC 36	NE intense black BR transparent bronze	XX	LED 18W - diffused beam 3000K*, 2700K

CE IP20 CRI>90 110-240VAC **LED** ~2151 lm\* ~119 lm/W\*

example composition code PT KWIC 36 XX XX LED

# Layers

Vanessa Vivian

Collezione composta da lampade a sospensione con struttura metallica rivestita con fettuccia di tessuto ignifugato pongé superliscio. Disponibile vari colori e dimensioni. Sorgente luminosa con attacco a vite.

Collection consisting of suspended lamps with a metal frame covered with strips of extra smooth flame-retardant pongé fabric. Available in several colours and sizes. Screw fitting light source.

## COLOURS



white



orange



warm white



gold yellow



light grey



dark grey



brick red



burgundy



red



light green



multicolor 1:  
RB+RS+AR+GI



multicolor 2:  
GS+GR+BC



white canopy

## SP LAY A

kg 26.2 m<sup>3</sup> 0.76

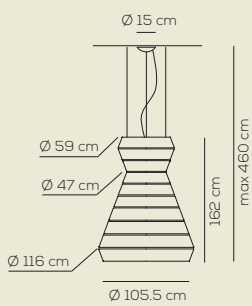

## LAYERS

Type	Article	Colours	Code End	Source
SP	LAY A XX E27	BC white	XX	E27 9 x Max 16W LED or 9 x Max 70W halo
		AR orange		
		BW warm white		
		GI gold yellow		
		GR light grey		
		GS dark grey		
		MT brick red		
		RB burgundy		
		RS red		
		VE light green		
		M1 multicolor 1: RB+RS+AR+GI		
		M2 multicolor 2: GS+GR+BC		



IP20 +LED

220-240V<sub>ac</sub>

example composition code SP LAYAXXE27 RS XX



# Layers

Vanessa Vivian

Collezione composta da lampade a sospensione con struttura metallica rivestita con fettuccia di tessuto ignifugato pongé superliscio. Disponibile vari colori e dimensioni. Sorgente luminosa con attacco a vite.

Collection consisting of suspended lamps with a metal frame covered with strips of extra smooth flame-retardant pongé fabric. Available in several colours and sizes. Screw fitting light source.

## SP LAY B

kg 48.5 m<sup>3</sup> 2.06

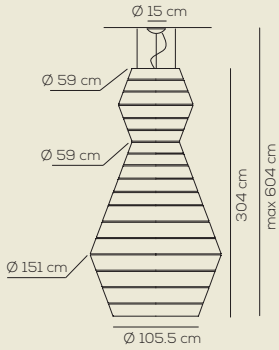

### LAYERS

Type	Article	Colours	Code End	Source
SP	LAY B XX E27	BC white AR orange BW warm white GI gold yellow GR light grey GS dark grey MT brick red RB burgundy RS red VE light green M1 multicolor 1: RB+RS+AR+GI M2 multicolor 2: GS+GR+BC	XX	E27 15 x Max 16W LED or 15 x Max 70W halo

IP20 +LED 220-240V<sub>AC</sub>  
 example composition code SP LAYBXXE27 M2 XX

## SP LAY C

kg 41.3 m<sup>3</sup> 1.71

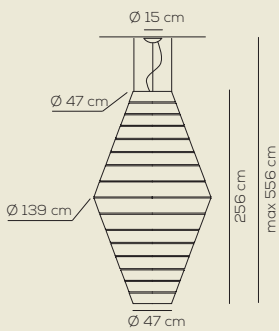

### LAYERS

Type	Article	Colours	Code End	Source
SP	LAY C XX E27	BC white AR orange BW warm white GI gold yellow GR light grey GS dark grey MT brick red RB burgundy RS red VE light green M1 multicolor 1: RB+RS+AR+GI M2 multicolor 2: GS+GR+BC	XX	E27 15 x Max 16W LED or 15 x Max 70W halo

IP20 +LED 220-240V<sub>AC</sub>  
 example composition code SP LAYCXXE27 GI XX

# Layers

Vanessa Vivian

Collezione composta da lampade a sospensione con struttura metallica rivestita con fettuccia di tessuto ignifugato pongé superliscio. Disponibile vari colori e dimensioni. Sorgente luminosa con attacco a vite.

Collection consisting of suspended lamps with a metal frame covered with strips of extra smooth flame-retardant pongé fabric. Available in several colours and sizes. Screw fitting light source.

## SP LAY D

kg 29.3 m<sup>3</sup> 0.76

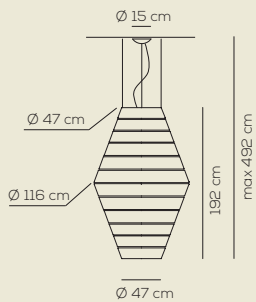

### LAYERS

Type	Article	Colours	Code End	Source
SP	LAY D XX E27	BC white AR orange BW warm white GI gold yellow GR light grey GS dark grey MT brick red RB burgundy RS red VE light green M1 multicolor 1: RB+RS+AR+GI M2 multicolor 2: GS+GR+BC	XX	E27 9 x Max 16W LED or 9 x Max 70W halo

CE IP20 +LED 220-240V<sub>AC</sub>  
example composition code SP LAYDXXE27 GI XX

## SP LAY E

kg 24.4 m<sup>3</sup> 1.71

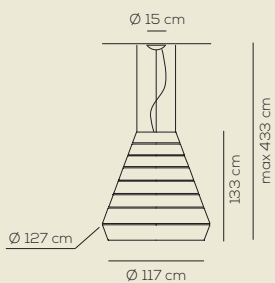

### LAYERS

Type	Article	Colours	Code End	Source
SP	LAY E XX E27	BC white AR orange BW warm white GI gold yellow GR light grey GS dark grey MT brick red RB burgundy RS red VE light green M1 multicolor 1: RB+RS+AR+GI M2 multicolor 2: GS+GR+BC	XX	E27 9 x Max 16W LED or 9 x Max 70W halo

CE IP20 +LED 220-240V<sub>AC</sub>  
example composition code SP LAYEXXE27 RS XX

# Layers

Vanessa Vivian

Collezione composta da lampade a sospensione con struttura metallica rivestita con fettuccia di tessuto ignifugato pongé superliscio. Disponibile vari colori e dimensioni. Sorgente luminosa con attacco a vite.

Collection consisting of suspended lamps with a metal frame covered with strips of extra smooth flame-retardant pongé fabric. Available in several colours and sizes. Screw fitting light source.

## SP LAY F

kg 25.1 m<sup>3</sup> 0.76

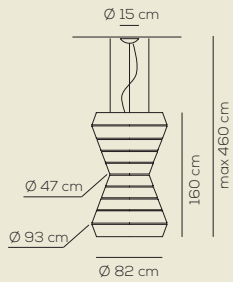

### LAYERS

Type	Article	Colours	Code End	Source
SP	LAY F XX E27	<p>BC white</p> <p>AR orange</p> <p>BW warm white</p> <p>GI gold yellow</p> <p>GR light grey</p> <p>GS dark grey</p> <p>MT brick red</p> <p>RB burgundy</p> <p>RS red</p> <p>VE light green</p> <p>M1 multicolor 1: RB+RS+AR+GI</p> <p>M2 multicolor 2: GS+GR+BC</p>	XX	E27 9 x Max 16W LED or 9 x Max 70W halo



 IP20 **+LED** 220-240V<sub>AC</sub>  
 example composition code SP LAYFXXE27 BC XX

# Liaison compositions

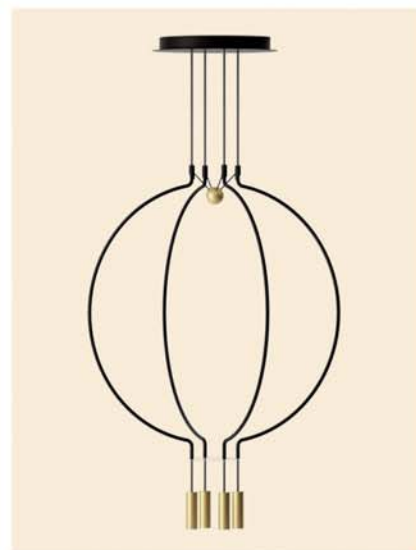
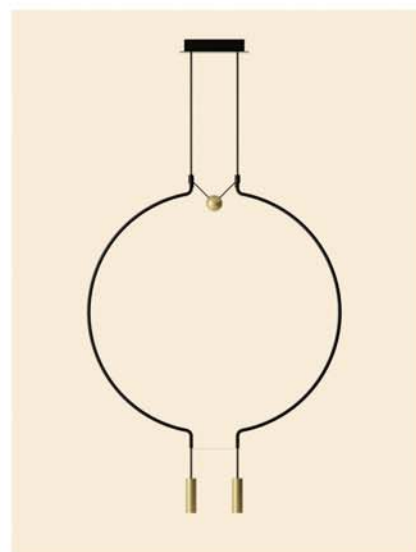
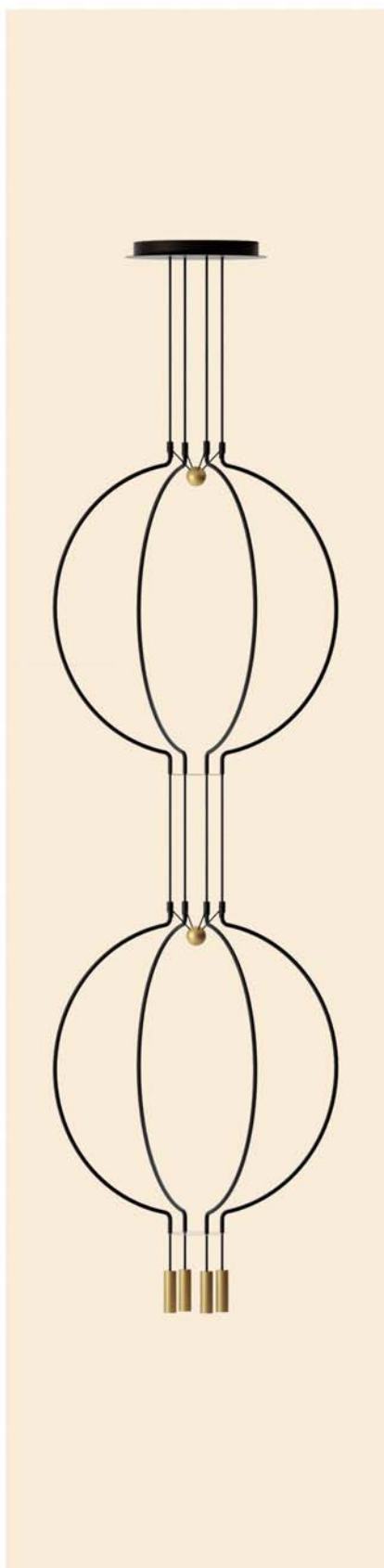

# Liaison colors legend

## BLACK / MATT GOLD

Arch colors / Final & sphere finishes

NE black / OO matt gold

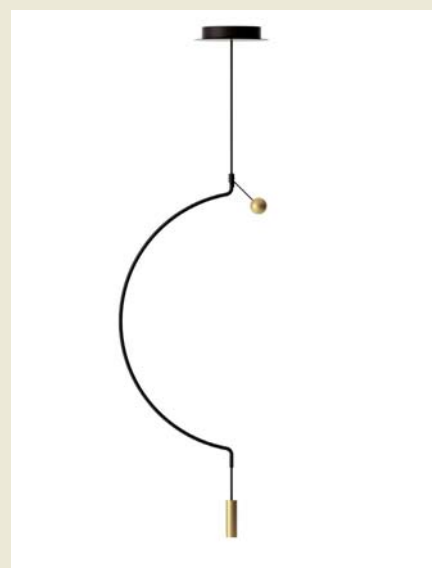

## MATT GOLD / BLACK

Arch colors / Final & sphere finishes

OO matt gold / NE black



## BLACK / BLACK

Arch colors / Final & sphere finishes

NE black / NE black

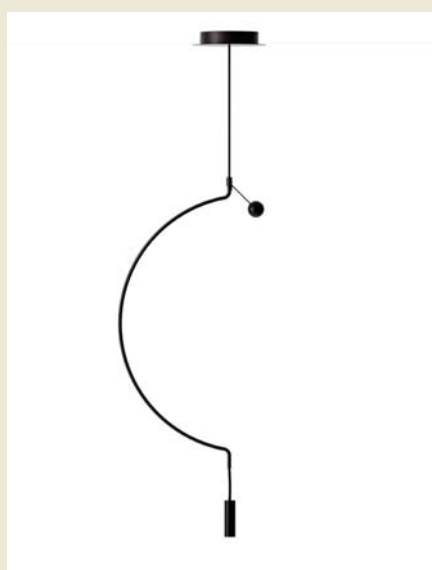

# Liaison

Sara Moroni

Collezione di lampade a sospensione in metallo. Disponibile in vari colori e dimensioni. La sorgente luminosa è a LED integrato dimmerabile.

Collection consisting of metal suspended lamps. Available in several colors and sizes. Built-in dimmable LED light source.

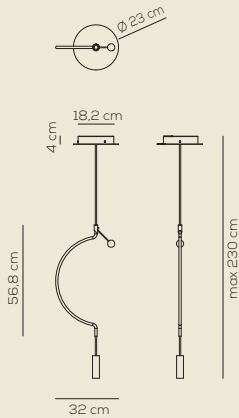

## SP LIAI P 1

kg 1,766 m<sup>3</sup> 0,0591



LIAISON / DRIVER INCLUDED

Type	Article	Arch / Final & sphere finishes	Source
SP	LIAI P 1	NE black / NE black	LED 9W - optic ~ 40° beam 3000K*, 2700K
		NE black / OO matt gold	
		OO matt gold / NE black	



 IP20 CRI>90 **LED** ~671 lm\* 75 lm/W\* 220-240VAC  
 example composition code SP LIAI P 1 NE NE LED

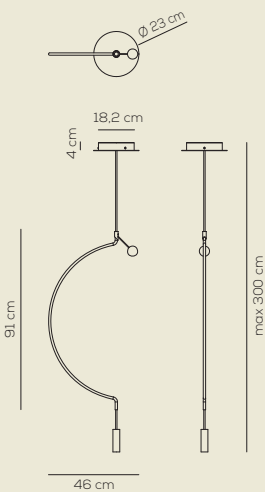

## SP LIAI M 1

kg 2,181 m<sup>3</sup> 0,0947



LIAISON / DRIVER INCLUDED

Type	Article	Arch / Final & sphere finishes	Source
SP	LIAI M 1	NE black / NE black	LED 9W - optic ~ 40° beam 3000K*, 2700K
		NE black / OO matt gold	
		OO matt gold / NE black	



 IP20 CRI>90 **LED** ~671 lm\* 75 lm/W\* 220-240VAC  
 example composition code SP LIAI M 1 OO NE LED

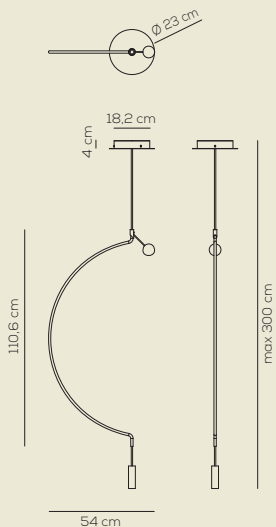

## SP LIAI G 1

kg 2,448 m<sup>3</sup> 0,16



LIAISON / DRIVER INCLUDED

Type	Article	Arch / Final & sphere finishes	Source
SP	LIAI G 1	NE black / NE black	LED 9W - optic ~ 40° beam 3000K*, 2700K
		NE black / OO matt gold	
		OO matt gold / NE black	



 IP20 CRI>90 **LED** ~671 lm\* 75 lm/W\* 220-240VAC  
 example composition code SP LIAI G 1 OO NE LED

# Liaison

Sara Moroni

Collezione di lampade a sospensione in metallo. Disponibile in vari colori e dimensioni. La sorgente luminosa è a LED integrato dimmerabile.

Collection consisting of metal suspended lamps. Available in several colors and sizes. Built-in dimmable LED light source.

## SP LIAI P 2

kg 2,549 m<sup>3</sup> 0,0591

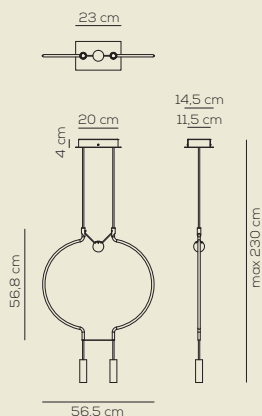

LIAISON / DRIVER INCLUDED

Type	Article	Arch / Final & sphere finishes	Source
SP	LIAI P 2	NE black / NE black	LED 2 x 9W - optic ~ 40° beam 3000K*, 2700K
		NE black / OO matt gold	
		OO matt gold / NE black	



IP20 CRI>90 **LED** ~1342 lm\* 75 lm/W\* 220-240VAc

example composition code SP LIAI P 2 NE NE LED

## SP LIAI M 2

kg 2,673 m<sup>3</sup> 0,0947

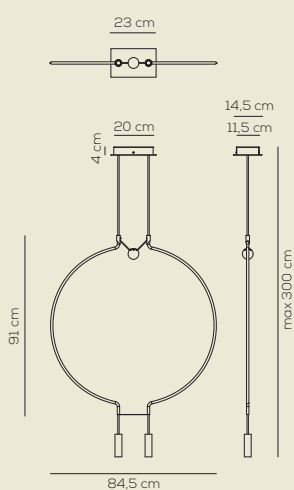

LIAISON / DRIVER INCLUDED

Type	Article	Arch / Final & sphere finishes	Source
SP	LIAI M 2	NE black / NE black	LED 2 x 9W - optic ~ 40° beam 3000K*, 2700K
		NE black / OO matt gold	
		OO matt gold / NE black	



IP20 CRI>90 **LED** ~1342 lm\* 75 lm/W\* 220-240VAc

example composition code SP LIAI M 2 OO NE LED

## SP LIAI G 2

kg 2,734 m<sup>3</sup> 0,16

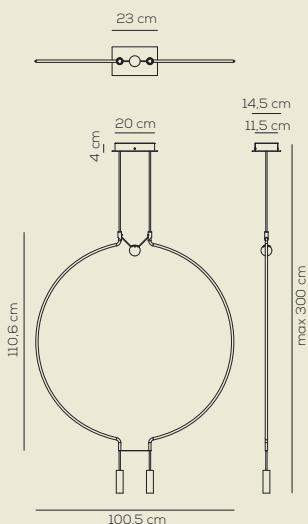

LIAISON / DRIVER INCLUDED

Type	Article	Arch / Final & sphere finishes	Source
SP	LIAI G 2	NE black / NE black	LED 2 x 9W - optic ~ 40° beam 3000K*, 2700K
		NE black / OO matt gold	
		OO matt gold / NE black	



IP20 CRI>90 **LED** ~1342 lm\* 75 lm/W\* 220-240VAc

example composition code SP LIAI G 2 OO NE LED

# Liaison

Sara Moroni

Collezione di lampade a sospensione in metallo. Disponibile in vari colori e dimensioni. La sorgente luminosa è a LED integrato dimmerabile.

Collection consisting of metal suspended lamps. Available in several colors and sizes. Built-in dimmable LED light source.

## SP LIAI P 4

kg 5,697 m<sup>3</sup> 0,1196

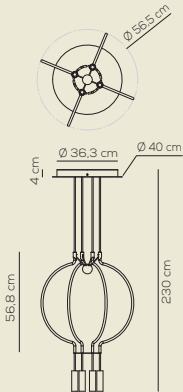

LIAISON / DRIVER INCLUDED

Type	Article	Arch / Final & sphere finishes	Source
SP	LIAI P 4	NE black / NE black	LED 4 x 7.5W - optic ~ 40° beam 3000K*, 2700K
		NE black / OO matt gold	
		OO matt gold / NE black	



 IP20 CRI>90 **LED** ~2684 lm\* 89 lm/W\* 220-240Vac  
 example composition code SP LIAI P 4 NE NE LED

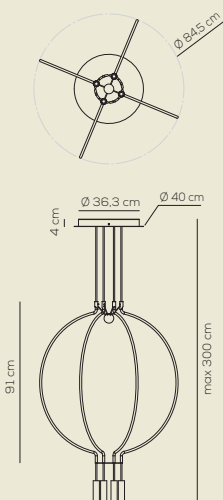

## SP LIAI M 4

kg 5,945 m<sup>3</sup> 0,2477



LIAISON / DRIVER INCLUDED

Type	Article	Arch / Final & sphere finishes	Source
SP	LIAI M 4	NE black / NE black	LED 4 x 7.5W - optic ~ 40° beam 3000K*, 2700K
		NE black / OO matt gold	
		OO matt gold / NE black	



 IP20 CRI>90 **LED** ~2684 lm\* 89 lm/W\* 220-240Vac  
 example composition code SP LIAI M 4 OO NE LED

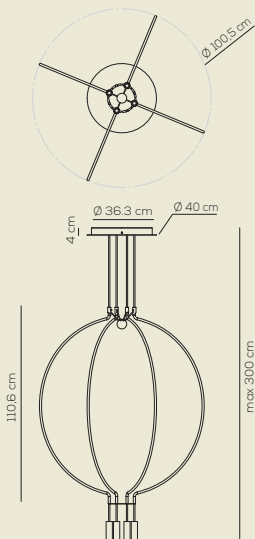

## SP LIAI G 4

kg 6,068 m<sup>3</sup> 0,1794



LIAISON / DRIVER INCLUDED

Type	Article	Arch / Final & sphere finishes	Source
SP	LIAI G 4	NE black / NE black	LED 4 x 7.5W - optic ~ 40° beam 3000K*, 2700K
		NE black / OO matt gold	
		OO matt gold / NE black	

 IP20 CRI>90 **LED** ~2684 lm\* 89 lm/W\* 220-240Vac  
 example composition code SP LIAI G 4 OO NE LED



# Liaison

Sara Moroni

Collezione di lampade a sospensione in metallo. Disponibile in vari colori e dimensioni. La sorgente luminosa è a LED integrato dimmerabile.

Collection consisting of metal suspended lamps. Available in several colors and sizes. Built-in dimmable LED light source.

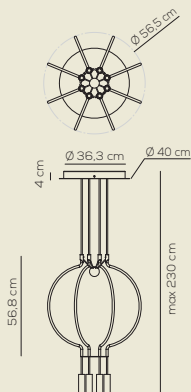

## SP LIAI P 8

kg 7,914 m<sup>3</sup> 0,1196



LIAISON / DRIVER INCLUDED

Type	Article	Arch / Final & sphere finishes	Source
SP	LIAI P 8	NE black / NE black	LED 8 x 7.5W - optic ~ 40° beam 3000K*, 2700K
		NE black / OO matt gold	
		OO matt gold / NE black	



 IP20 CRI>90 **LED** ~5368 lm\* 89 lm/W\* 220-240Vac  
 example composition code SP LIAI P 8 NE NE LED

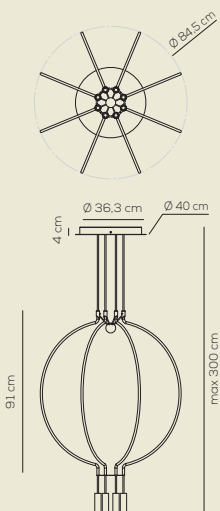

## SP LIAI M 8

kg 8,41 m<sup>3</sup> 0,2477



LIAISON / DRIVER INCLUDED

Type	Article	Arch / Final & sphere finishes	Source
SP	LIAI M 8	NE black / NE black	LED 8 x 7.5W - optic ~ 40° beam 3000K*, 2700K
		NE black / OO matt gold	
		OO matt gold / NE black	



 IP20 CRI>90 **LED** ~5368 lm\* 89 lm/W\* 220-240Vac  
 example composition code SP LIAI M 8 OO NE LED

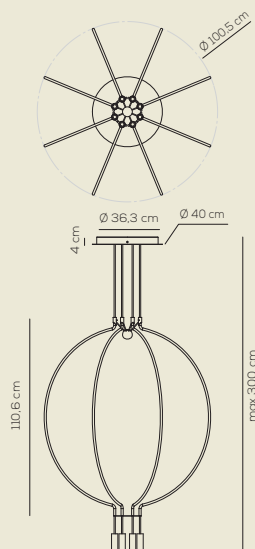

## SP LIAI G 8

kg 8,656 m<sup>3</sup> 0,1794



LIAISON / DRIVER INCLUDED

Type	Article	Arch / Final & sphere finishes	Source
SP	LIAI G 8	NE black / NE black	LED 8 x 7.5W - optic ~ 40° beam 3000K*, 2700K
		NE black / OO matt gold	
		OO matt gold / NE black	



 IP20 CRI>90 **LED** ~5368 lm\* 89 lm/W\* 220-240Vac  
 example composition code SP LIAI G 8 OO NE LED

# Liaison

Sara Moroni

Collezione di lampade a sospensione in metallo. Disponibile in vari colori e dimensioni. La sorgente luminosa è a LED integrato dimmerabile.

Collection consisting of metal suspended lamps. Available in several colors and sizes. Built-in dimmable LED light source.

## SP LIAD P 2

kg 3,678 m<sup>3</sup> 0,0759

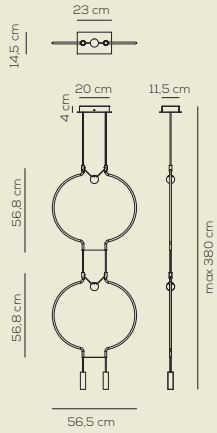

LIAISON / DRIVER INCLUDED

Type	Article	Arch / Final & sphere finishes	Source
SP	LIAD P 2	NE black / NE black	LED 2 x 9W - optic ~ 40° beam 3000K*, 2700K
		NE black / OO matt gold	
		OO matt gold / NE black	



IP20 CRI>90 **LED** ~1342 lm\* 75 lm/W\* 220-240VAC

example composition code SP LIAD P 2 NE NE LED

## SP LIAD M 2

kg 4,12 m<sup>3</sup> 0,0947

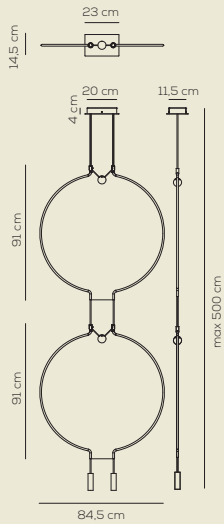

LIAISON / DRIVER INCLUDED

Type	Article	Arch / Final & sphere finishes	Source
SP	LIAD M 2	NE black / NE black	LED 2 x 9W - optic ~ 40° beam 3000K*, 2700K
		NE black / OO matt gold	
		OO matt gold / NE black	



IP20 CRI>90 **LED** ~1342 lm\* 75 lm/W\* 220-240VAC

example composition code SP LIAD M 2 OO NE LED

## SP LIAD G 2

kg 4,28 m<sup>3</sup> 0,1605

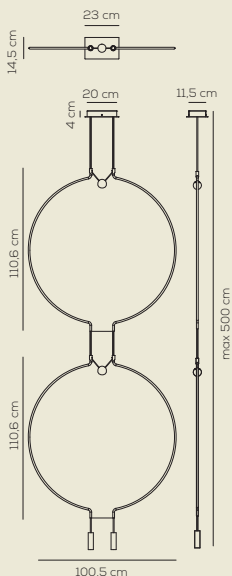

LIAISON / DRIVER INCLUDED

Type	Article	Arch / Final & sphere finishes	Source
SP	LIAD G 2	NE black / NE black	LED 2 x 9W - optic ~ 40° beam 3000K*, 2700K
		NE black / OO matt gold	
		OO matt gold / NE black	



IP20 CRI>90 **LED** ~1342 lm\* 75 lm/W\* 220-240VAC

example composition code SP LIAD G 2 OO NE LED

# Liaison

Sara Moroni

Collezione di lampade a sospensione in metallo. Disponibile in vari colori e dimensioni. La sorgente luminosa è a LED integrato dimmerabile.

Collection consisting of metal suspended lamps. Available in several colors and sizes. Built-in dimmable LED light source.

## SP LIAD P 4

kg 7,355 m<sup>3</sup> 0,0948

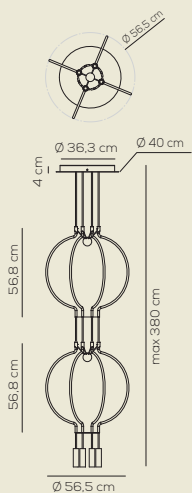

LIAISON / DRIVER INCLUDED

Type	Article	Arch / Final & sphere finishes	Source
SP	LIAD P 4	NE black / NE black	LED 4 x 7.5W - optic ~ 40° beam 3000K*, 2700K
		NE black / OO matt gold	
		OO matt gold / NE black	



 IP20 CRI>90 **LED** ~2684 lm\* 89 lm/W\* 220-240Vac  
 example composition code SP LIAD P 4 NE NE LED

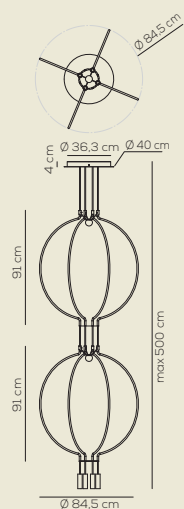

## SP LIAD M 4

kg 8,241 m<sup>3</sup> 0,2477



LIAISON / DRIVER INCLUDED

Type	Article	Arch / Final & sphere finishes	Source
SP	LIAD M 4	NE black / NE black	LED 4 x 7.5W - optic ~ 40° beam 3000K*, 2700K
		NE black / OO matt gold	
		OO matt gold / NE black	



 IP20 CRI>90 **LED** ~2684 lm\* 89 lm/W\* 220-240Vac  
 example composition code SP LIAD M 4 OO NE LED

## SP LIAD G 4

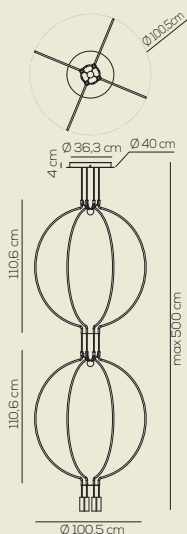
kg 8,559 m<sup>3</sup> 0,1794



LIAISON / DRIVER INCLUDED

Type	Article	Arch / Final & sphere finishes	Source
SP	LIAD G 4	NE black / NE black	LED 4 x 7.5W - optic ~ 40° beam 3000K*, 2700K
		NE black / OO matt gold	
		OO matt gold / NE black	



 IP20 CRI>90 **LED** ~2684 lm\* 89 lm/W\* 220-240Vac  
 example composition code SP LIAD G 4 OO NE LED

# Liaison

Sara Moroni

Collezione di lampade a sospensione in metallo. Disponibile in vari colori e dimensioni. La sorgente luminosa è a LED integrato dimmerabile.

Collection consisting of metal suspended lamps. Available in several colors and sizes. Built-in dimmable LED light source.

## SP LIAD P 8

kg 10,631 m<sup>3</sup> 0,0948

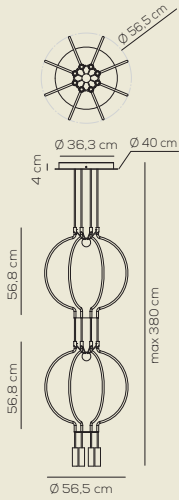

LIAISON / DRIVER INCLUDED

Type	Article	Arch / Final & sphere finishes	Source
SP	LIAD P 8	NE black / NE black	LED 8 x 7.5W - optic ~ 40° beam 3000K*, 2700K
		NE black / OO matt gold	
		OO matt gold / NE black	



 IP20 CRI>90 **LED** ~5368 lm\* 89 lm/W\* 220-240Vac  
 example composition code SP LIAD P 8 NE NE LED

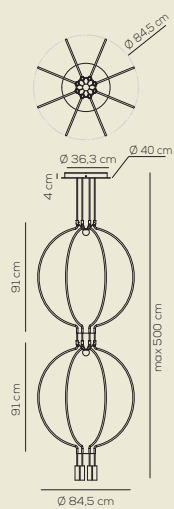

## SP LIAD M 8

kg 12,401 m<sup>3</sup> 0,2477



LIAISON / DRIVER INCLUDED

Type	Article	Arch / Final & sphere finishes	Source
SP	LIAD M 8	NE black / NE black	LED 8 x 7.5W - optic ~ 40° beam 3000K*, 2700K
		NE black / OO matt gold	
		OO matt gold / NE black	



 IP20 CRI>90 **LED** ~5368 lm\* 89 lm/W\* 220-240Vac  
 example composition code SP LIAD M 8 OO NE LED

## SP LIAD G 8

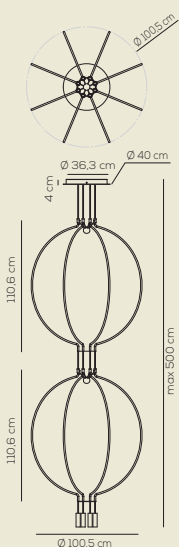
kg 13,039 m<sup>3</sup> 0,1794



LIAISON / DRIVER INCLUDED

Type	Article	Arch / Final & sphere finishes	Source
SP	LIAD G 8	NE black / NE black	LED 8 x 7.5W - optic ~ 40° beam 3000K*, 2700K
		NE black / OO matt gold	
		OO matt gold / NE black	



 IP20 CRI>90 **LED** ~5368 lm\* 89 lm/W\* 220-240Vac  
 example composition code SP LIAD G 8 OO NE LED

# Lik

S. & R. Cornelissen

Lampada da parete in alluminio disponibile in tre colori. Sorgente luminosa a LED integrato dimmerabile.

Aluminium wall lamp available in three colours. Built-in dimmable LED light.

## COLOURS



wrinkle white



matt bronze



matt nickel

## AP LIK

kg 0,5 m³ 0,02

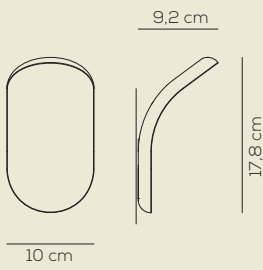

### LIK

Type	Article	Colours	Code End	Source
AP	LIK XXX	BC wrinkled white BR matt bronze NI matt nickel	XX	LED 16,6W - diffused beam 3000K*, 2700K, 4000K

IP20 CRI90
 
 ADA 220-240V<sub>AC</sub>

 ~1480 lm\* 89 lm/W\*

example composition code AP LIKXXX BR XX LED

# Manto

Davide Besozzi

Collezione di lampade a sospensione con struttura metallica in alluminio e acciaio. Diffusore in vetro soffiato e tessuto elastico removibile. Il diffusore è regolabile nella posizione in altezza. Disponibile in tre dimensioni. Sorgente luminosa a LED integrato dimmerabile.

Collection consisting of aluminum and steel suspended lamps. Blown opaline glass and elastic removable fabric diffuser. The height position of the diffuser can be adjust. Available in three sizes. Built-in dimmable LED light source.

## COLOUR



white fabric and light grey finishings

## SP MAN 070

kg 4,36 m<sup>3</sup> 0,382

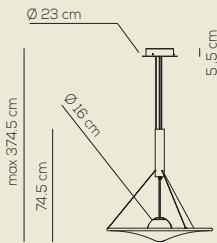
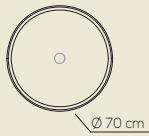

### MANTO / DRIVER INCLUDED

Type	Article	Colours	Finishings	Source
SP	MAN 070	GR light grey	XX	LED 18W - diffused beam 3000K*, 2700K

100-277VAC **LED** ~1956 lm\* ~108 lm/W\*  
 example composition code SP MAN070 GR XX LED

## SP MAN 120

kg 6,27 m<sup>3</sup> 0,194

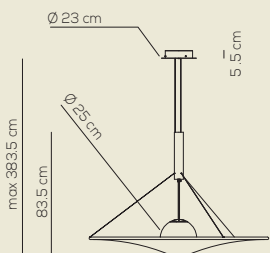
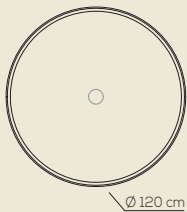

### MANTO / DRIVER INCLUDED

Type	Article	Colours	Finishings	Source
SP	MAN 120	GR light grey	XX	LED 24W - diffused beam 3000K*, 2700K

100-277VAC **LED** ~2507 lm\* ~104 lm/W\*  
 example composition code SP MAN120 GR XX LED

# Manto

Davide Besozzi

Collezione di lampade a sospensione con struttura metallica in alluminio e acciaio. Diffusore in vetro soffiato e tessuto elastico removibile. Il diffusore è regolabile nella posizione in altezza. Disponibile in tre dimensioni. Sorgente luminosa a LED integrato dimmerabile.

Collection consisting of aluminum and steel suspended lamps. Blown opaline glass and elastic removable fabric diffuser. The height position of the diffuser can be adjust. Available in three sizes. Built-in dimmable LED light source.

## SP MAN 180

kg 9,23 m³ 0,475

### MANTO / DRIVER INCLUDED

Type	Article	Colours	Finishings	Source
SP	MAN 180	GR light grey	XX	LED 28W - diffused beam 3000K*, 2700K

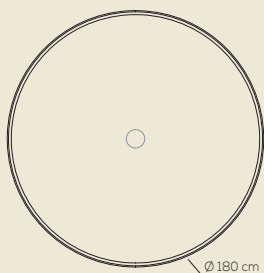

Ø180 cm

IP20 CRI>90 dimmable 0/1-10V 100-277V<sub>AC</sub> LED ~2894 lm\* ~103 lm/W\*

example composition code SP MAN 180 GR XX LED

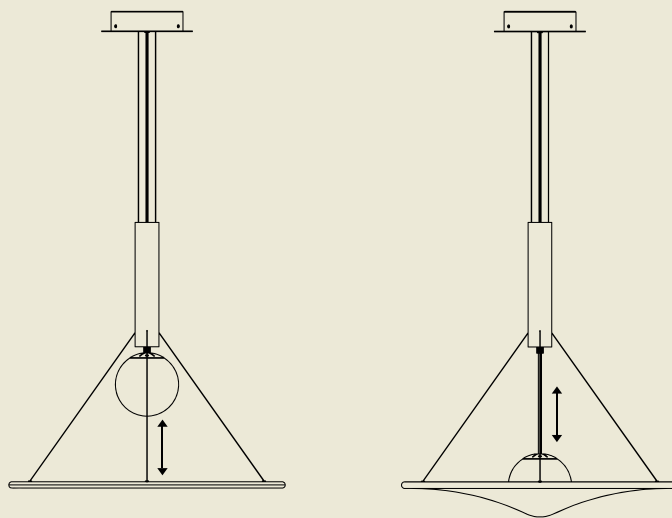
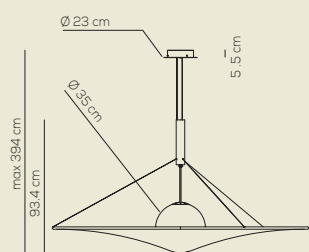

# Melting pot

Sandro Santantonio

Collezione composta da lampade da parete, lampade a sospensione e lampade da terra. I paralumi sono proposti con diversi pattern decorativi. Diffusori opalescenti disponibili su richiesta. Sorgente luminosa con attacco a vite.

Collection consisting of wall lamps, suspended lamps and floor lamps. The lampshades coming in various decorative patterns. Opalescent diffusers available on request. Screw fitting light source.

## FC: NEW LIGHT PATTERNS

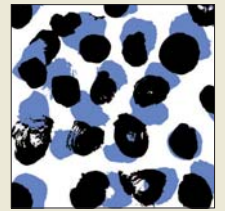
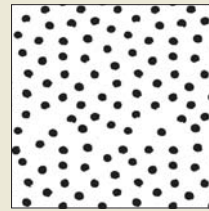
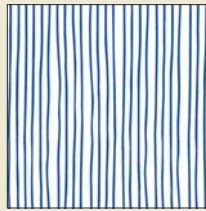
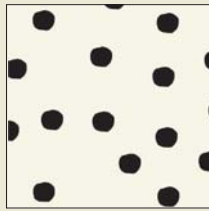

## FS: NEW DARK PATTERNS

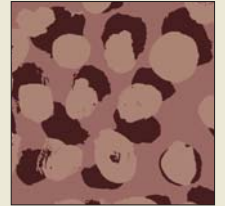
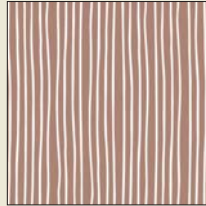
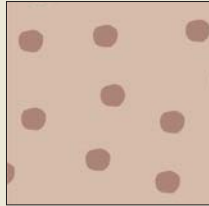

white inside

## BC / BA / BO: LIGHT PATTERNS

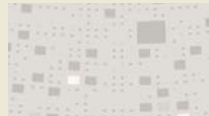

light patterns / white inside



light patterns / silver inside

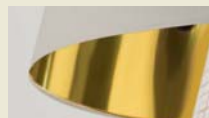

light patterns / gold inside

## NA / NE: DARK PATTERNS

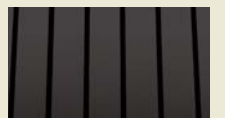
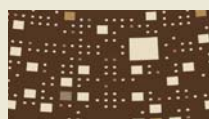

dark patterns / silver inside



dark patterns / gold inside

## DETAILS



floor lamp finish



white canopy



diffuser optional



# Melting pot

Sandro Santantonio

Collezione composta da lampade a sospensione e lampade da terra. I paralumi sono proposti con diversi pattern decorativi. Diffusori opalescenti disponibili su richiesta. Sorgente luminosa con attacco a vite.

Collection consisting of suspended lamps and floor lamps. The lampshades coming in various decorative patterns. Opalescent diffusers available on request. Screw fitting light source.

## AP MELTIN

kg 1 m<sup>3</sup> 0.04

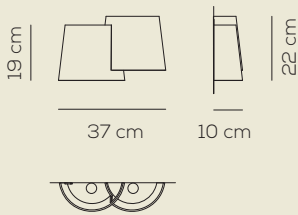

### MELTING POT

Type	Article	Colours	Code end	Source
AP	MELTIN	<p><b>FC</b> light patterns outside / white inside</p> <p><b>FS</b> dark patterns outside / white inside</p> <p><b>BC</b> light patterns outside / white inside</p> <p><b>BO</b> light patterns outside / gold inside</p> <p><b>NE</b> dark patterns outside / gold inside</p>	<p><b>XX</b> white varnished metal</p>	<p><b>E27</b> 2 x Max 16W LED or 2 x Max 30W halo</p>

Gli articoli in rosso sono disponibili solo fino ad esaurimento scorte. Articles in red are available until sold out

IP20 **ADA** **+LED** 220-240V<sub>ac</sub>

example composition code AP MELTIN FC XX E27

## SP MELT 60

kg 2.5 m<sup>3</sup> 0.14

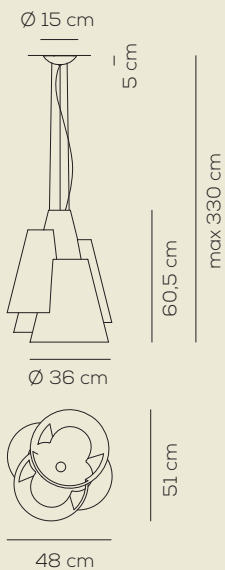

### MELTING POT / diffusore NON INCLUSO / diffuser NOT INCLUDED

Type	Article	Colours	Code end	Source
SP	MELT 60	<p><b>FC</b> light patterns outside / white inside</p> <p><b>FS</b> dark patterns outside / white inside</p> <p><b>BC</b> light patterns outside / white inside</p> <p><b>BA</b> light patterns outside / silver inside</p> <p><b>BO</b> light patterns outside / gold inside</p> <p><b>NA</b> dark patterns outside / silver inside</p> <p><b>NE</b> dark patterns outside / gold inside</p>	<p><b>XX</b> white varnished metal</p>	<p><b>E27</b> 1 x Max 16W LED or 1 x Max 70W halo</p>

Gli articoli in rosso sono disponibili solo fino ad esaurimento scorte. Articles in red are available until sold out

IP20 **+LED** 220-240V<sub>ac</sub>

example composition code SP MELT60 FS XX E27

DSPMELTING60XXX optional: diffusori (2 pezzi) / diffusers (2 pieces)

# Melting pot

Sandro Santantonio

Collezione composta da lampade a sospensione e lampade da terra. I paralumi sono proposti con diversi pattern decorativi. Diffusori opalescenti disponibili su richiesta. Sorgente luminosa con attacco a vite.

Collection consisting of suspended lamps and floor lamps. The lampshades coming in various decorative patterns. Opalescent diffusers available on request. Screw fitting light source.

## SP MEL 115

kg 4.5 m<sup>3</sup> 0.17

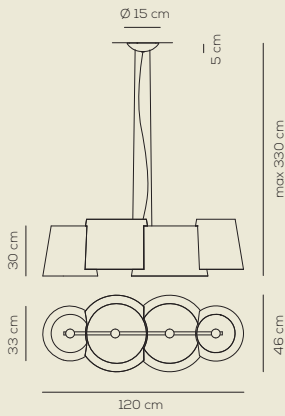

MELTING POT / diffusore NON INCLUSO / diffuser NOT INCLUDED

Type	Article	Colours	Code end	Source
SP	MEL 115	<p><b>FC</b> light patterns outside / white inside</p> <p><b>FS</b> dark patterns outside / white inside</p> <p><b>BC</b> light patterns outside / white inside</p> <p><b>BA</b> light patterns outside / silver inside</p> <p><b>BO</b> light patterns outside / gold inside</p> <p><b>NA</b> dark patterns outside / silver inside</p> <p><b>NE</b> dark patterns outside / gold inside</p>	XX white varnished metal	E27 4 x Max 16W LED or 4 x Max 70W halo

Gli articoli in rosso sono disponibili solo fino ad esaurimento scorte. Articles in red are available until sold out

CE IP20 +LED 220-240V<sub>ac</sub>

example composition code SP MEL115 NE XX E27

DSPMELTING115XX optional: diffusori (4 pezzi) / diffusers (4 pieces)

## SP MEL 120

kg 5 m<sup>3</sup> 0.39

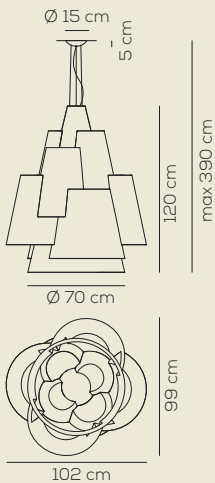

MELTING POT / diffusore NON INCLUSO / diffuser NOT INCLUDED

Type	Article	Colours	Code end	Source
SP	MEL 120	<p><b>FC</b> light patterns outside / white inside</p> <p><b>FS</b> dark patterns outside / white inside</p> <p><b>BC</b> light patterns outside / white inside</p> <p><b>BA</b> light patterns outside / silver inside</p> <p><b>BO</b> light patterns outside / gold inside</p> <p><b>NA</b> dark patterns outside / silver inside</p> <p><b>NE</b> dark patterns outside / gold inside</p>	XX white varnished metal	E27 3 x Max 16W LED or 3 x Max 70W halo

Gli articoli in rosso sono disponibili solo fino ad esaurimento scorte. Articles in red are available until sold out

CE IP20 +LED 220-240V<sub>ac</sub>

example composition code SP MEL120 NE XX E27

DSPMELTING120XX optional: diffusore (1 pezzo) / diffuser (1 piece)

# Melting pot

Sandro Santantonio

Collezione composta da lampade a sospensione e lampade da terra. I paralumi sono proposti con diversi pattern decorativi. Diffusori opalescenti disponibili su richiesta. Sorgente luminosa con attacco a vite.

Collection consisting of suspended lamps and floor lamps. The lampshades coming in various decorative patterns. Opalescent diffusers available on request. Screw fitting light source.

## PT MELT 55

kg 11.2 m<sup>3</sup> 0.356

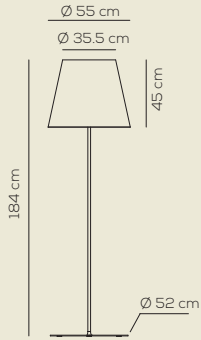

### MELTING POT

Type	Article	Colours	Code end	Source
PT	MELT 55	<p><b>FC</b> light patterns outside / white inside</p> <p><b>FS</b> dark patterns outside / white inside</p> <p><b>BA</b> two light patterns outside / silver inside</p> <p><b>BO</b> two light patterns outside / gold inside</p> <p><b>NA</b> two dark patterns outside / silver inside</p> <p><b>NE</b> two dark patterns outside / gold inside</p>	<b>GR</b> grey varnished metal	<b>E27</b> 3 x Max 16W LED or 3 x Max 70W fluo (dimnable lamps required)

Gli articoli in rosso sono disponibili solo fino ad esaurimento scorte. Articles in red are available until sold out

220-240V<sub>AC</sub>  
 example composition code **PT MELT55 BO GR E27**

## PT MELT 80

kg 12 m<sup>3</sup> 0.68

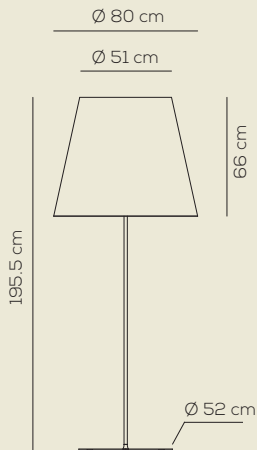

### MELTING POT

Type	Article	Colours	Code end	Source
PT	MELT 80	<p><b>FC</b> light patterns outside / white inside</p> <p><b>FS</b> dark patterns outside / white inside</p> <p><b>BA</b> two light patterns outside / silver inside</p> <p><b>BO</b> two light patterns outside / gold inside</p> <p><b>NA</b> two dark patterns outside / silver inside</p> <p><b>NE</b> two dark patterns outside / gold inside</p>	<b>GR</b> grey varnished metal	<b>E27</b> 3 x Max 16W LED or 3 x Max 70W fluo (dimnable lamps required)

Gli articoli in rosso sono disponibili solo fino ad esaurimento scorte. Articles in red are available until sold out

220-240V<sub>AC</sub>  
 example composition code **PT MELT80 BA GR E27**

# Mountain View

Dima Loginoff

Lampada a sospensione realizzata in vetro soffiato trasparente disponibile in vari colori. Sorgente luminosa a LED integrato dimmerabile.

*Suspended lamp made of transparent blown glass, available in several colours. Built-in dimmable LED light source.*

## COLOURS



crystal / chrome



crystal / gold



amber / gold



grey / chrome



chrome canopy



gold canopy

## SP MOUNTA

kg 16 m<sup>3</sup> 0.22

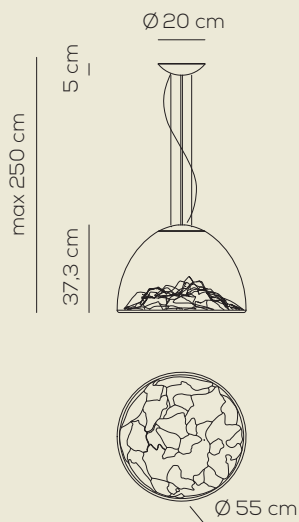

### MOUNTAIN VIEW / DRIVER INCLUDED

Type	Article	Colours / Finish	Source
SP	MOUNTA	CS / CR crystal / chrome	LED 18W - 3000K
		CS / OR crystal / gold	
		AM / OR amber / gold	
		GR / CR grey / chrome	



IP20



CRI 80

LED

~2285 lm 127 lm/W

220-240Vac

example composition code SP MOUNTA AM OR LED

# Muse

Sandro Santantonio

Collezione di lampade da soffitto, da parete, e da tavolo con struttura metallica e rivestimento in tessuto elasticizzato, sfoderabile e lavabile. Disponibile in vari colori e dimensioni. Sorgente luminosa con attacco a vite.

*Collection consisting of ceiling or wall lamps, and table lamps with metal frame and removable, washable elastic fabric covering. Available in several colours and sizes. Screw fitting light source.*

## COLOURS



white

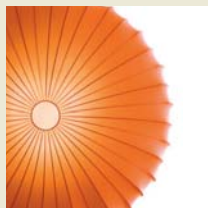

orange



light blue



dark blue



fuchsia



yellow



pink

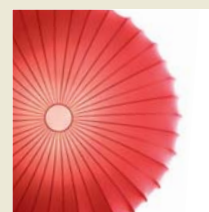

red



green



violet



multicolor

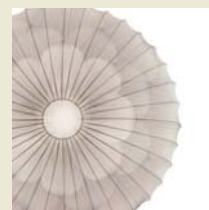

flower



sticks



white for table lamp

# Muse

Sandro Santantonio

Collezione di lampade da soffitto, da parete, e da tavolo con struttura metallica e rivestimento in tessuto elasticizzato, sfoderabile e lavabile. Disponibile in vari colori e dimensioni. Sorgente luminosa con attacco a vite.

Collection consisting of ceiling or wall lamps, and table lamps with metal frame and removable, washable elastic fabric covering. Available in several colours and sizes. Screw fitting light source.

## PL MUSE 40

kg 1 m<sup>3</sup> 0.03

MUSE / tessuto INCLUSO, kit lente NON PREVISTO / fabric INCLUDED, glass diffuser kit NOT AVAILABLE  
/ applicazione a soffitto o a parete / application: both as ceiling or wall lamp

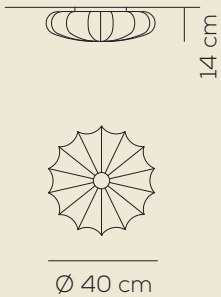

Type	Article	Colours	Finish	Source
PL	MUSE 40	BC white	XX white metal	E27 1 x Max 6,5W LED or 1 x Max 42W halo
		AR orange		
		AZ light blue		
		BL dark blue		
		FU fuchsia		
		GI yellow		
		RO pink		
		RS red		
		VE green		
		VI violet		
		MC multicolour		
		FI flower		
		ST sticks		

CE IP20 +LED 220-240VAc

example composition code PL MUSE40 GI XX E27

### TESSUTI SUPPLEMENTARI SU RICHIESTA / ADDITIONAL FABRICS UPON REQUEST:

TSPLMUSE40	white
TSPLMUSE40AR	orange
TSPLMUSE40AZ	light blue
TSPLMUSE40BL	dark blue
TSPLMUSE40FU	fuchsia
TSPLMUSE40GI	yellow
TSPLMUSE40RO	pink
TSPLMUSE40RS	red
TSPLMUSE40VE	green
TSPLMUSE40VI	violet
TSPLMUSE40MC	multicolour
TSPLMUSE40FI	flower
TSPLMUSE40ST	sticks

# Muse

Sandro Santantonio

Collezione di lampade da soffitto, da parete, e da tavolo con struttura metallica e rivestimento in tessuto elasticizzato, sfoderabile e lavabile. Disponibile in vari colori e dimensioni. Sorgente luminosa con attacco a vite.

Collection consisting of ceiling or wall lamps, and table lamps with metal frame and removable, washable elastic fabric covering. Available in several colours and sizes. Screw fitting light source.

## PL MUSE 60

kg 1.5 m<sup>3</sup> 0.09

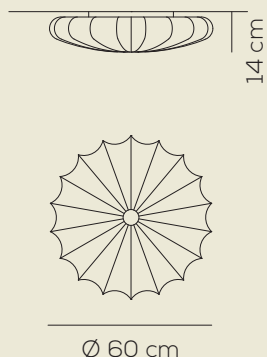

**MUSE** / tessuto INCLUSO, kit lente NON PREVISTO / fabric INCLUDED, glass diffuser kit NOT AVAILABLE  
/ applicazione a soffitto o a parete / application: both as ceiling or wall lamp

Type	Article	Colours	Finish	Source
PL	MUSE 60	<b>BC</b> white <b>AR</b> orange <b>AZ</b> light blue <b>BL</b> dark blue <b>FU</b> fuchsia <b>GI</b> yellow <b>RO</b> pink <b>RS</b> red <b>VE</b> green <b>VI</b> violet <b>MC</b> multicolour <b>FI</b> flower <b>ST</b> sticks	<b>XX</b> white metal	<b>E27</b> 2 x Max 6,5W LED or 2 x Max 42W halo

CE IP20 +LED 220-240V<sub>AC</sub>

example composition code PL MUSE60 ST XX E27

### TESSUTI SUPPLEMENTARI SU RICHIESTA / ADDITIONAL FABRICS UPON REQUEST:

TSPLMUSE60	white
TSPLMUSE60AR	orange
TSPLMUSE60AZ	light blue
TSPLMUSE60BL	dark blue
TSPLMUSE60FU	fuchsia
TSPLMUSE60GI	yellow
TSPLMUSE60RO	pink
TSPLMUSE60RS	red
TSPLMUSE60VE	green
TSPLMUSE60VI	violet
TSPLMUSE60MC	multicolour
TSPLMUSE60FI	flower
TSPLMUSE60ST	sticks

# Muse

Sandro Santantonio

Collezione di lampade da soffitto, da parete, e da tavolo con struttura metallica e rivestimento in tessuto elasticizzato, sfoderabile e lavabile. Disponibile in vari colori e dimensioni. Sorgente luminosa con attacco a vite.

Collection consisting of ceiling or wall lamps, and table lamps with metal frame and removable, washable elastic fabric covering. Available in several colours and sizes. Screw fitting light source.

## PL MUSE 80

kg 4 m<sup>3</sup> 0.13

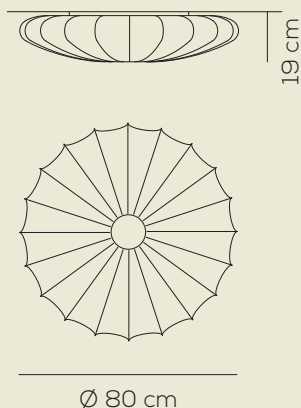

**MUSE** / tessuto INCLUSO, kit lente NON INCLUSO / fabric INCLUDED, glass diffuser kit NOT INCLUDED  
/ applicazione a soffitto o a parete / application: both as ceiling or wall lamp

Type	Article	Colours	Finish	Source
PL	MUSE 80	BC white	XX white metal	E27 3 x Max 16W LED or 3 x Max 70W halo
		AR orange		
		AZ light blue		
		BL dark blue		
		FU fuchsia		
		GI yellow		
		RO pink		
		RS red		
		VE green		
		VI violet		
		MC multicolour		
		FI flower		
		ST sticks		

CE IP20 +LED 220-240V<sub>ac</sub>

example composition code PL MUSE80 MC XX E27

KPLMUSE

optional: kit lente **solo** per E27 con lampadina LED  
optional: glass diffuser kit **only** for E27 when mounting LED bulb

### TESSUTI SUPPLEMENTARI SU RICHIESTA / ADDITIONAL FABRICS UPON REQUEST:

TSPLMUSE80	white
TSPLMUSE80AR	orange
TSPLMUSE80AZ	light blue
TSPLMUSE80BL	dark blue
TSPLMUSE80FU	fuchsia
TSPLMUSE80GI	yellow
TSPLMUSE80RO	pink
TSPLMUSE80RS	red
TSPLMUSE80VE	green
TSPLMUSE80VI	violet
TSPLMUSE80MC	multicolour
TSPLMUSE80FI	flower
TSPLMUSE80ST	sticks



# Muse

Sandro Santantonio

Collezione di lampade da soffitto, da parete, e da tavolo con struttura metallica e rivestimento in tessuto elasticizzato, sfoderabile e lavabile. Disponibile in vari colori e dimensioni. Sorgente luminosa con attacco a vite.

Collection consisting of ceiling or wall lamps, and table lamps with metal frame and removable, washable elastic fabric covering. Available in several colours and sizes. Screw fitting light source.

## PL MUS 120

kg 7 m<sup>3</sup> 0.31

MUSE / tessuto INCLUSO, kit lente NON INCLUSO / fabric INCLUDED, glass diffuser kit NOT INCLUDED  
/ applicazione a soffitto o a parete / application: both as ceiling or wall lamp

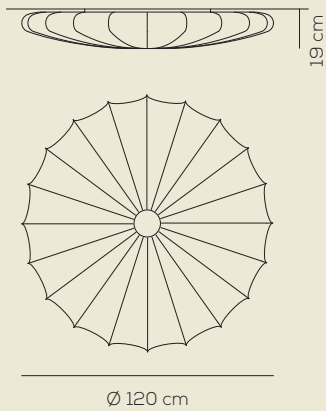

Type	Article	Colours	Finish	Source
PL	MUS 120	BC white	XX white metal	E27 3 x Max 16W LED or 3 x Max 70W halo
		AR orange		
		AZ light blue		
		BL dark blue		
		FU fuchsia		
		GI yellow		
		RO pink		
		RS red		
		VE green		
		VI violet		
		MC multicolour		
		FI flower		
		ST sticks		

CE IP20 +LED 220-240VAc

example composition code PL MUS120 VE XX E27

KPLMUSE

optional: kit lente **solo** per E27 con lampadina LED  
optional: glass diffuser kit **only** for E27 when mounting LED bulb

### TESSUTI SUPPLEMENTARI SU RICHIESTA / ADDITIONAL FABRICS UPON REQUEST:

TSPLMUSE120	white
TSPLMUSE120AR	orange
TSPLMUSE120AZ	light blue
TSPLMUSE120BL	dark blue
TSPLMUSE120FU	fuchsia
TSPLMUSE120GI	yellow
TSPLMUSE120RO	pink
TSPLMUSE120RS	red
TSPLMUSE120VE	green
TSPLMUSE120VI	violet
TSPLMUSE120MC	multicolour
TSPLMUSE120FI	flower
TSPLMUSE120ST	sticks

# Muse

Sandro Santantonio

Collezione di lampade da soffitto, da parete, e da tavolo con struttura metallica e rivestimento in tessuto elasticizzato, sfoderabile e lavabile. Disponibile in vari colori e dimensioni. Sorgente luminosa con attacco a vite.

Collection consisting of ceiling or wall lamps, and table lamps with metal frame and removable, washable elastic fabric covering. Available in several colours and sizes. Screw fitting light source.

## LT MUSE P

kg 2 m<sup>3</sup> 0.025

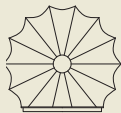

22 cm

33 cm



29,4 cm

13 cm

MUSE / tessuto INCLUSO / fabric INCLUDED

Type	Article	Colours	Finish	Source
LT	MUSE P X	BC white	XX white metal	E14 1 x Max 6,5W LED or 1 x Max 42W halo

Gli articoli in rosso sono disponibili solo fino ad esaurimento scorte. Articles in red are available until sold out



IP20 +LED

220-240VAc

example composition code LT MUSEPX BC XX E14

# Nafir

Karim Rashid

Collezione composta da lampade a sospensione in ABS ad iniezione. Disponibile in vari colori. Sorgente luminosa LED con attacco GU10.

Collection consisting of suspended lamps in injection moulded ABS. Available in several colours. LED light source with GU10 fitting.

## COLOURS



white / white



chrome / white



white / gold

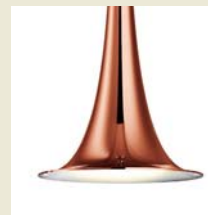

bronze / white



pink gold / white

## SP NAFIR 1

kg 1.1 m<sup>3</sup> 0.04

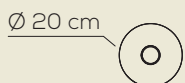
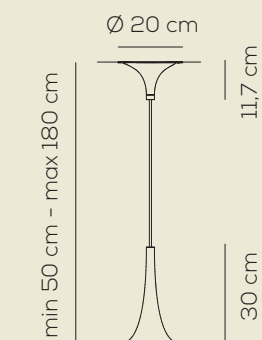

### NAFIR

Type	Article	Colours / Finish	Source
SP	NAFIR 1	BC / BC white / white	GU1 GU10 LED 1 x Max 5,5W only LED bulb
		CR / BC chrome / white	
		BC / OR white / gold	
		BR / BC bronze / white	
		RO / BC pink gold / white	

Gli articoli in rosso sono disponibili solo fino ad esaurimento scorte. Articles in red are available until sold out

CE IP20 LED 220-240VAC

example composition code SP NAFIR1 CR BC GU1

optional for more info see page 306

LAMPGU105,5W040 Optional GU10 LED bulb 5,5W - 3000K - 40° angle

## SP NAFIR 3

kg 2.9 m<sup>3</sup> 0.15

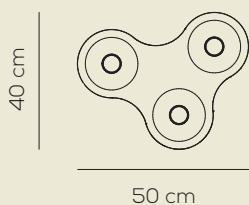
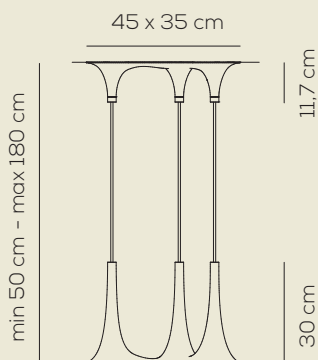

### NAFIR

Type	Article	Colours / Finish	Source
SP	NAFIR 3	BC / BC white / white	GU1 GU10 LED 3 x Max 5,5W only LED bulb
		CR / BC chrome / white	
		BC / OR white / gold	
		BR / BC bronze / white	
		RO / BC pink gold / white	

Gli articoli in rosso sono disponibili solo fino ad esaurimento scorte. Articles in red are available until sold out

CE IP20 LED 220-240VAC

example composition code SP NAFIR3 RO BC GU1

optional for more info see page 306

LAMPGU105,5W040 Optional GU10 LED bulb 5,5W - 3000K - 40° angle

Collezione di lampade da soffitto, da parete, con struttura metallica e rivestimento in tessuto elasticizzato, sfoderabile e lavabile. Disponibile in vari colori e dimensioni. Sorgente luminosa con attacco a vite.

Collection consisting of ceiling or wall lamps, with metal frame and removable, washable elastic fabric covering. Available in several colours and sizes. Screw fitting light source.

## COLOURS



white



ivory pattern

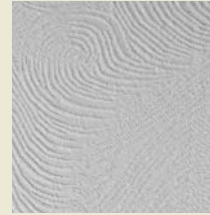

white pattern

## PL NELL 60

kg 2 m<sup>3</sup> 0.06

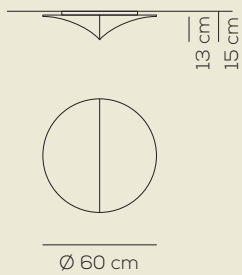

NELLY / tessuto INCLUSO / fabric INCLUDED

Type	Article	Colours	Finish	Source
PL	NELL 60	BC white  FA ivory pattern  FB white pattern	XX white metal	E27 2 x Max 16W LED or 2 x Max 70W halo

Gli articoli in rosso sono disponibili solo fino ad esaurimento scorte. Articles in red are available until sold out.

CE IP20 +LED 220-240V<sub>ac</sub>

example composition code PL NELL60 FA XX E27

### TESSUTI SUPPLEMENTARI SU RICHIESTA / ADDITIONAL FABRICS UPON REQUEST:

TSPLNELLY60BC	white
TSPLNELLY60FA	ivory pattern
TSPLNELLY60FB	white pattern

## PL NEL 100

kg 4 m<sup>3</sup> 0.17

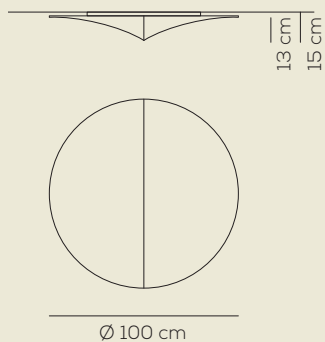

NELLY / tessuto INCLUSO / fabric INCLUDED

Type	Article	Colours	Finish	Source
PL	NEL 100	BC white  FA ivory pattern  FB white pattern	XX white metal	E27 3 x Max 16W LED or 3 x Max 70W halo

Gli articoli in rosso sono disponibili solo fino ad esaurimento scorte. Articles in red are available until sold out.

CE IP20 +LED 220-240V<sub>ac</sub>

example composition code PL NEL100 FB XX E27

### TESSUTI SUPPLEMENTARI SU RICHIESTA / ADDITIONAL FABRICS UPON REQUEST:

TSPLNELLY100BC	white
TSPLNELLY100FA	ivory pattern
TSPLNELLY100FB	white pattern

# Nelly

Manuel Vivian

Collezione di lampade da soffitto, da parete, con struttura metallica e rivestimento in tessuto elasticizzato, sfoderabile e lavabile. Disponibile in vari colori e dimensioni. Sorgente luminosa con attacco a vite.

Collection consisting of ceiling or wall lamps, with metal frame and removable, washable elastic fabric covering. Available in several colours and sizes. Screw fitting light source.

## PL NEL 140

kg 6 m<sup>3</sup> 0.5

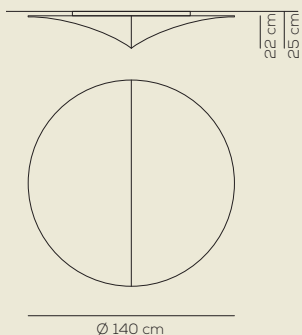

**NELLY** / tessuto INCLUSO / fabric INCLUDED

Type	Article	Colours	Finish	Source
PL	NEL 140	BC white	XX white metal	<b>E27</b> 4 x Max 16W LED or 4 x Max 70W halo



IP20 **+LED**

220-240V<sub>ac</sub>

example composition code PL NEL140 BC XX E27

TESSUTI SUPPLEMENTARI SU RICHIESTA / ADDITIONAL FABRICS UPON REQUEST:

TSPLNELLY140BC white

# Nelly straight

Manuel Vivian

Collezione di lampade da soffitto, da parete, con struttura metallica e rivestimento in tessuto elasticizzato, sfoderabile e lavabile. Disponibile in vari colori e dimensioni. Sorgente luminosa con attacco a vite.

Collection consisting of ceiling or wall lamps, with metal frame and removable, washable elastic fabric covering. Available in several colours and sizes. Screw fitting light source.

## COLOURS



white



ivory pattern



white pattern

## PL NEL S 60

kg 2 m<sup>3</sup> 0.06

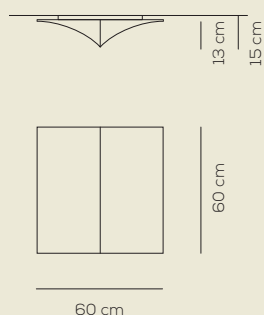

### NELLY STRAIGHT / tessuto INCLUSO / fabric INCLUDED

Type	Article	Colours	Finish	Source
PL	NEL S 60	BC white  FA ivory pattern  FB white pattern	XX white metal	E27 2 x Max 16W LED or 2 x Max 70W halo

Gli articoli in rosso sono disponibili solo fino ad esaurimento scorte. Articles in red are available until sold out.

CE IP20 +LED 220-240V<sub>AC</sub>

example composition code PL NELS60 FA XX E27

### TESSUTI SUPPLEMENTARI SU RICHIESTA / ADDITIONAL FABRICS UPON REQUEST:

TSPLNELLYQ60BC white

TSPLNELLYQ60FA ivory pattern

TSPLNELLYQ60FB white pattern

## PL NE S 100

kg 4 m<sup>3</sup> 0.17

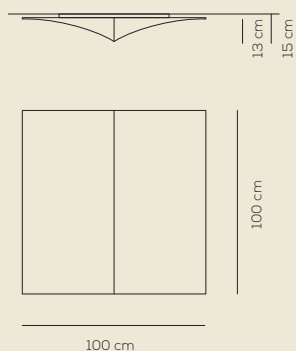

### NELLY / tessuto INCLUSO / fabric INCLUDED

Type	Article	Colours	Finish	Source
PL	NE S 100	BC white  FA ivory pattern  FB white pattern	XX white metal	E27 3 x Max 16W LED or 3 x Max 70W halo

Gli articoli in rosso sono disponibili solo fino ad esaurimento scorte. Articles in red are available until sold out.

CE IP20 +LED 220-240V<sub>AC</sub>

example composition code PL NES100 FB XX E27

### TESSUTI SUPPLEMENTARI SU RICHIESTA / ADDITIONAL FABRICS UPON REQUEST:

TSPLNELLYQ100BC white

TSPLNELLYQ100FA ivory pattern

TSPLNELLYQ100FB white pattern

# Nelly straight

Manuel Vivian

Collezione di lampade da soffitto, da parete, con struttura metallica e rivestimento in tessuto elasticizzato, sfoderabile e lavabile. Disponibile in vari colori e dimensioni. Sorgente luminosa con attacco a vite.

Collection consisting of ceiling or wall lamps, with metal frame and removable, washable elastic fabric covering. Available in several colours and sizes. Screw fitting light source.

## PL NE S 140

kg 6 m<sup>3</sup> 0.5

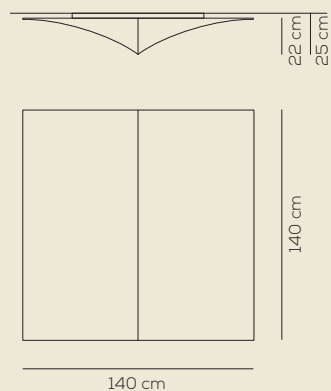

**NELLY** / tessuto INCLUSO / fabric INCLUDED

Type	Article	Colours	Finish	Source
PL	NE S 140	BC white	XX white metal	E27 4 x Max 16W LED or 4 x Max 70W halo

CE IP20 +LED 220-240V<sub>ac</sub>

example composition code PL NE S 140 BC XX E27

TESSUTI SUPPLEMENTARI SU RICHIESTA / ADDITIONAL FABRICS UPON REQUEST:

TSPLNELLYQ140BC white

# Orchid

Rainer Mutsch

Collezione composta da lampade da parete, soffitto, sospensione, terra e da tavolo in alluminio. Disponibile in tre colori. La sorgente luminosa è a LED integrato dimmerabile.

Collection consisting of aluminium wall lamps, ceiling lamps, suspended lamps, floor lamps and table lamps. Available in three colours. Built-in dimmable LED light source.

## COLOURS



white



sand

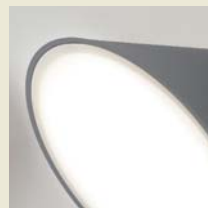

anthracite grey

## DETAILS



white canopy

## AP ORCHID

kg 1 m<sup>3</sup> 0.02

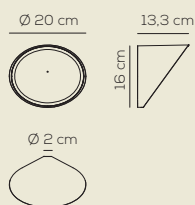

ORCHID / applicazione a soffitto o a parete / application: both as ceiling or wall lamp

Type	Article	Colours	Code End	Source
AP	ORCHID	BC white	XX	LED 10W - diffused beam 3000K*, 2700K, 4000K
		SA sand		
		AN anthracite grey		

IP20 CRI90
 
 220-240VAC **LED** ~800 lm\* 80lm/W\*

example composition code AP ORCHID SA XX LED

## PL ORCHID

kg 6 m<sup>3</sup> 0.07

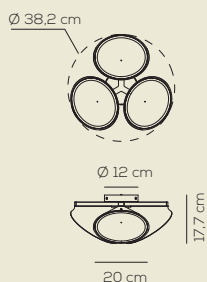

ORCHID

Type	Article	Colours	Code End	Source
AP	ORCHID	BC white	XX	LED 3 x 10W - diffused beam 3000K*, 2700K, 4000K
		SA sand		
		AN anthracite grey		

IP20 CRI90
 
 220-240VAC **LED** 3 x ~800 lm\* 80lm/W\*

example composition code PL ORCHID SA XX LED



# Orchid

Rainer Mutsch

Collezione composta da lampade da parete, soffitto, sospensione, terra e da tavolo in alluminio. Disponibile in tre colori. La sorgente luminosa è a LED integrato dimmerabile.

Collection consisting of aluminium wall lamps, ceiling lamps, suspended lamps, floor lamps and table lamps. Available in three colours. Built-in dimmable LED light source.

## SP ORCHI 3

kg 6 m<sup>3</sup> 0.18

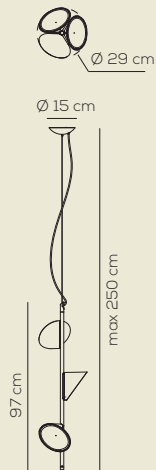

### ORCHID

Type	Article	Colours	Code End	Source
SP	ORCHI 3	BC white	XX	LED 3 x 10W - diffused beam 3000K*, 2700K, 4000K
		SA sand		
		AN anthracite grey		

220-240V<sub>AC</sub> **LED** 3 x ~800 lm\* 90lm/W\*  
 example composition code SP ORCHI3 SA XX LED

## SP ORCHI 4

kg 8 m<sup>3</sup> 0.2

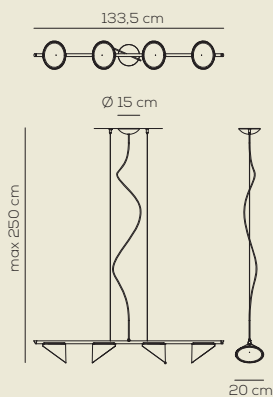

### ORCHID

Type	Article	Colours	Code End	Source
SP	ORCHI 4	BC white	XX	LED 4 x 10W - diffused beam 3000K*, 2700K, 4000K
		SA sand		
		AN anthracite grey		

220-240V<sub>AC</sub> **LED** 4 x ~800 lm\* 80lm/W\*  
 example composition code SP ORCHI3 BC XX LED

## PT ORCHID

kg 13 m<sup>3</sup> 0.2

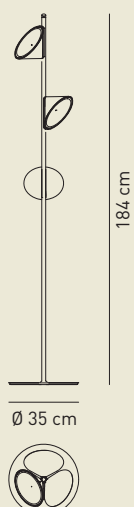

### ORCHID / DIMMER INCLUDED

Type	Article	Colours	Code End	Source
PT	ORCHID	BC white	XX	LED 3 x 7W - diffused beam 3000K*, 2700K
		SA sand		
		AN anthracite grey		

220-240V<sub>AC</sub> **LED** 3 x ~710 lm\* 101lm/W\*  
 example composition code PT ORCHID AN XX LED

# Orchid

Rainer Mutsch

Collezione composta da lampade da parete, soffitto, sospensione, terra e da tavolo in alluminio. Disponibile in tre colori. La sorgente luminosa è a LED integrato dimmerabile.

Collection consisting of aluminium wall lamps, ceiling lamps, suspended lamps, floor lamps and table lamps. Available in three colours. Built-in dimmable LED light source.



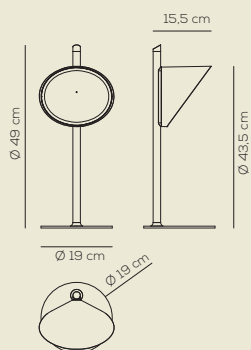

## LT ORCHID

kg 2,5 m³ 0.07



### ORCHID / DIMMER INCLUDED

Type	Article	Colours	Code End	Source
LT	ORCHID	BC white SA sand AN anthracite grey	XX	LED 7W - diffused beam 3000K*, 2700K



 IP20 CRI90  220-240V<sub>Ac</sub>  ~710 lm\* 101lm/W\*  
 example composition code LT ORCHID BC XX LED

# Plumage

Vanessa Vivian

Collezione composta da lampade da sospensione e lampade da terra con struttura in metallo verniciato bianco e diffusori in tessuto TREVIRA® CS ignifugato. Disponibile in vari colori e dimensioni. Sorgente luminosa con attacco a vite.

Collection consisting of suspended lamps and floor lamps with white metal frame and fabric diffusers covered with flame-retardant TREVIRA® CS. Available in several colours and sizes. Screw fitting light source.

## COLOURS



white



orange



fuchsia



light grey

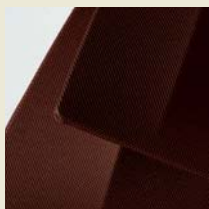

brown

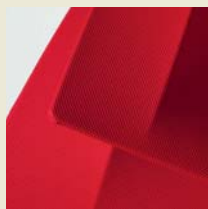

red



light green



multicolor

## DETAILS



canopy



floor lamp

## SP PLU 080

kg 11 m<sup>3</sup> 0.41



### PLUMAGE

Type	Article	Colours	Finish	Source
SP	PLU 080 E27	BC white AR orange FU fuchsia GR light grey MA brown RS red VE light green MC multicolor	XX	E27 3 x Max 16W LED or 3 x Max 70W halo



IP20 +LED

220-240VAc

example composition code SP PLU080E27 GR XX

# Plumage

Vanessa Vivian

Collezione composta da lampade da sospensione e lampade da terra con struttura in metallo verniciato bianco e diffusori in tessuto TREVIRA® CS ignifugato. Disponibile in vari colori e dimensioni. Sorgente luminosa con attacco a vite.

Collection consisting of suspended lamps and floor lamps with white metal frame and fabric diffusers covered with flame-retardant TREVIRA® CS. Available in several colours and sizes. Screw fitting light source.

## SP PLU 120

kg 18 m<sup>3</sup> 0.74

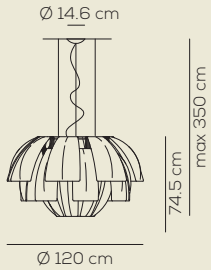

### PLUMAGE

Type	Article	Colours	Finish	Source
SP	PLU 120 E27	BC white AR orange FU fuchsia GR light grey MA brown RS red VE light green MC multicolor	XX	E27 6 x Max 16W LED or 6 x Max 70W halo

CE IP20 +LED 220-240V<sub>ac</sub>

example composition code SP PLU120E27 GR XX

## SP PLU 180

kg 32.2 m<sup>3</sup> 1.93



### PLUMAGE

Type	Article	Colours	Finish	Source
SP	PLU 180 E27	BC white AR orange FU fuchsia GR light grey MA brown RS red VE light green MC multicolor	XX	E27 6 x Max 16W LED or 6 x Max 70W halo

CE IP20 +LED 220-240V<sub>ac</sub>

example composition code SP PLU180E27 GR XX

## PT PLU 180

kg 70 m<sup>3</sup> 2.06

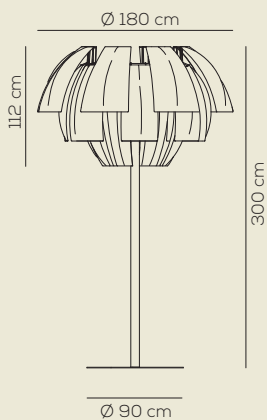

### PLUMAGE

Type	Article	Colours	Finish	Source
SP	PLU 080 E27	BC white AR orange FU fuchsia GR light grey MA brown RS red VE light green MC multicolor	XX	E27 6 x Max 70W halo (dimmmable lamps required)

CE IP20 dimmable 220-240V<sub>ac</sub>

example composition code SP PLU180E27 GR XX

# Polia

Manuel Vivian

Collezione composta da lampade da parete in metallo, disponibile in tre colori e due dimensioni. Sorgente luminosa a LED integrato dimmerabile.

Collection consisting of metal wall lamps available in three colours two sizes. Built-in dimmable LED light source.

## COLOURS



textured white

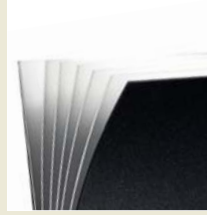

white and basalt grey

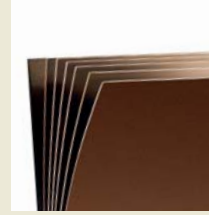

rust brown

## AP POLIA P

kg 2 m<sup>3</sup> 0.025

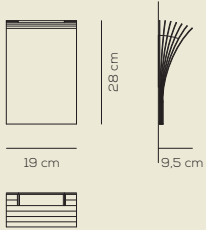

### POLIA

Type	Article	Colours	Code End	Source
AP	POLIA P	BC textured white GR white and basalt grey CO rust brown	XX	LED 16W - diffused beam 3000K*, 2700K, 4000K

220-240V<sub>AC</sub> ~1120 lm\* 70lm/W\*

example composition code AP POLIAP GR XX LED

## AP POLIA G

kg 4.8 m<sup>3</sup> 0.04

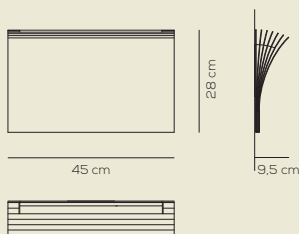

### POLIA

Type	Article	Colours	Code End	Source
AP	POLIA G	BC textured white GR white and basalt grey CO rust brown	XX	LED 24W - diffused beam 3000K*, 2700K, 4000K

220-240V<sub>AC</sub> ~1680 lm\* 70lm/W\*

example composition code AP POLIAG CO XX LED

# Rythmos

S. & R. Cornelissen

Collezione composta da lampade da parete e lampade a sospensione in metallo bianco. Sorgente luminosa a LED integrato monoemissione o biemissione.

Collection consisting of wall lamps and suspended lamps in white metal. Built-in LED light source mono-emitting or bi-emitting.

## COLOURS



white



white canopy

## RYTHMOS WALL

kg 1.3 m<sup>3</sup> 0.0069

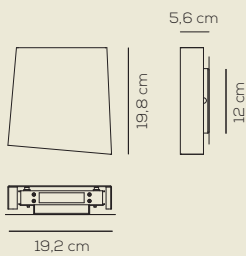

RYTHMOS / LED 9W (monoemitting) or 18W (biemitting) / DRIVER INCLUDED

Zone	Type	Article	System compatibility	Finish	LED colour temperature	Beam options
E	1	111	<b>8</b> mono emitting <b>9</b> biemitting	<b>07</b> white 9016 matt	<b>1</b> 3000 K	<b>4</b> diffused

Gli articoli in rosso sono disponibili solo fino ad esaurimento scorte. Articles in red are available until sold out.

IP20 **ADA** CRI85 **LED** ~777 lm - 86 lm/W (monoemitting) ~1554 lm - 86 lm/W (biemitting) 220-240VAC  
 example composition code E 1 111 8 07 1 4

## RYTHMOS HEAD WALL

kg 1.3 m<sup>3</sup> 0.0069

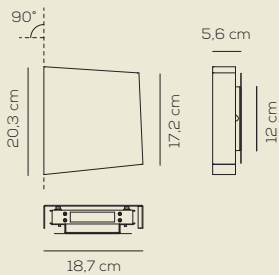

RYTHMOS / LED 9W (monoemitting) or 18W (biemitting) / DRIVER INCLUDED

Zone	Type	Article	System compatibility	Finish	LED colour temperature	Beam options
E	1	112	<b>8</b> mono emitting <b>9</b> biemitting	<b>07</b> white 9016 matt	<b>1</b> 3000 K	<b>4</b> diffused

Gli articoli in rosso sono disponibili solo fino ad esaurimento scorte. Articles in red are available until sold out.

IP20 **ADA** CRI85 **LED** ~777 lm - 86 lm/W (monoemitting) ~1554 lm - 86 lm/W (biemitting) 220-240VAC  
 example composition code E 1 112 9 07 1 4

## RYTHMOS SUSPENSION

kg 1.9 m<sup>3</sup> 0.0065

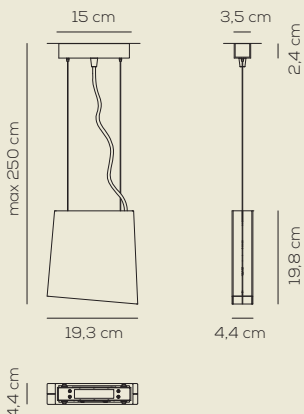

RYTHMOS / LED 9W (monoemitting) / LED 15W (biemitting) / DRIVER INCLUDED

Zone	Type	Article	System compatibility	Finish	LED colour temperature	Beam options
E	2	115	<b>1</b> monopoint canopy version	<b>07</b> white 9016 matt	<b>1</b> 3000 K	<b>4</b> diffused
E	2	116	<b>1</b> monopoint canopy version	<b>07</b> white 9016 matt	<b>1</b> 3000 K	<b>4</b> diffused

Gli articoli in rosso sono disponibili solo fino ad esaurimento scorte. Articles in red are available until sold out.

IP20 **ADA** CRI85 **LED** ~777 lm - 86 lm/W (monoemitting) ~1554 lm - 104 lm/W (biemitting) 220-240VAC  
 example composition code E 2 116 1 07 1 4

# Shatter

Manuel Vivian

Collezione composta da lampade da soffitto e sospensione in alluminio bianco. Disponibile in tre dimensioni. Sorgente luminosa a LED integrato dimmerabile.

Collection consisting ceiling lamps and suspended lamps in white aluminium. Available in three sizes. Built-in dimmable LED light source.

## COLOURS



white



white canopy

## PL SHATT P

kg 5.5 m<sup>3</sup> 0.07

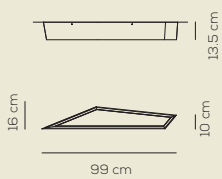

### SHATTER / DRIVER INCLUDED

Type	Article	Colours	Code End	Source
PL	SHATT P LED	BC white	XX	LED 35W - diffused beam 3000K*, 4000K

Gli articoli in rosso sono disponibili solo fino ad esaurimento scorte. Articles in red are available until sold out.

IP20 CRI80 **LED** ~4960 lm\* 142 lm/W\* 110-240VAC  
 example composition code PL SHATTPLED BC XX

## PL SHATT M

kg 8 m<sup>3</sup> 0.13

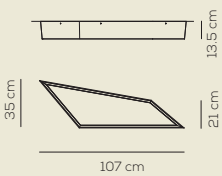

### SHATTER / DRIVER INCLUDED

Type	Article	Colours	Code End	Source
PL	SHATT M LED	BC white	XX	LED 70W - diffused beam 3000K*, 4000K

Gli articoli in rosso sono disponibili solo fino ad esaurimento scorte. Articles in red are available until sold out.

IP20 CRI80 **LED** ~9920 lm\* 142 lm/W\* 110-240VAC  
 example composition code PL SHATTMLED BC XX

## PL SHATT G

kg 11.5 m<sup>3</sup> 0.19

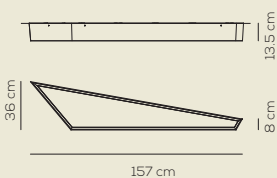

### SHATTER / DRIVER INCLUDED

Type	Article	Colours	Code End	Source
PL	SHATT G LED	BC white	XX	LED 105W - diffused beam 3000K*, 4000K

Gli articoli in rosso sono disponibili solo fino ad esaurimento scorte. Articles in red are available until sold out.

IP20 CRI80 **LED** ~14880 lm\* 142 lm/W\* 110-240VAC  
 example composition code PL SHATTGLEED BC XX

# Shatter

Manuel Vivian

Collezione composta da lampade da soffitto e sospensione in alluminio bianco. Disponibile in tre dimensioni. Sorgente luminosa a LED integrato dimmerabile.

Collection consisting ceiling lamps and suspended lamps in white aluminium. Available in three sizes. Built-in dimmable LED light source.

## SP SHATT P

kg 6.5 m<sup>3</sup> 0.07

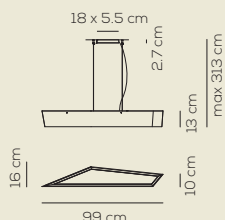

SHATTER / DRIVER INCLUDED / solo luce verso il basso / downward lighting only

Type	Article	Colours	Code End	Source
SP	SHATT P LED	BC white	XX	LED 35W - diffused beam 3000K*, 4000K

Gli articoli in rosso sono disponibili solo fino ad esaurimento scorte. Articles in red are available until sold out.

IP20 CRI80 **LED** ~4960 lm\* 142 lm/W\* 110-240VAC  
 example composition code SP SHATTPLED BC XX

## SP SHATT M

kg 9 m<sup>3</sup> 0.13

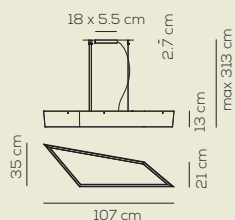

SHATTER / DRIVER INCLUDED / solo luce verso il basso / downward lighting only

Type	Article	Colours	Code End	Source
SP	SHATT M LED	BC white	XX	LED 70W - diffused beam 3000K*, 4000K

Gli articoli in rosso sono disponibili solo fino ad esaurimento scorte. Articles in red are available until sold out.

IP20 CRI80 **LED** ~9920 lm\* 142 lm/W\* 110-240VAC  
 example composition code SP SHATTMLED BC XX

## SP SHATT G

kg 12 m<sup>3</sup> 0.19

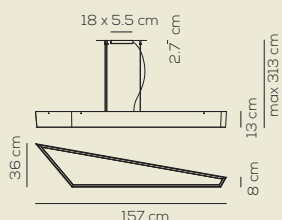

SHATTER / DRIVER INCLUDED / solo luce verso il basso / downward lighting only

Type	Article	Colours	Code End	Source
SP	SHATT G LED	BC white	XX	LED 105W - diffused beam 3000K*, 4000K

Gli articoli in rosso sono disponibili solo fino ad esaurimento scorte. Articles in red are available until sold out.

IP20 CRI80 **LED** ~14880 lm\* 142 lm/W\* 110-240VAC  
 example composition code SP SHATTGLED BC XX



# Skin

Manuel Vivian

Collezione composta da lampade da soffitto e lampade a sospensione con paralume in ecopelle ignifuga. Disponibile in vari colori e dimensioni. Sorgente luminosa con attacco a vite o a LED integrato dimmerabile.

Collection consisting of ceiling lamps and suspended lamps. The lampshade is covered with flame-retardant eco-leather. Available in several colours and sizes. Screw fitting or built-in dimmable LED light source.

## COLOURS



white

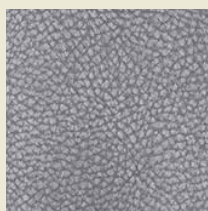

silver

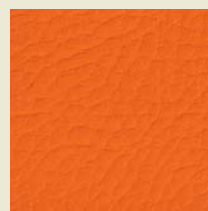

orange



light blue



ivory white



brown

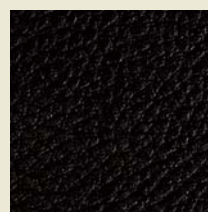

matt black

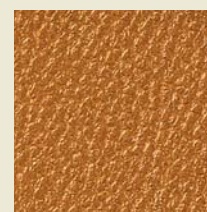

gold

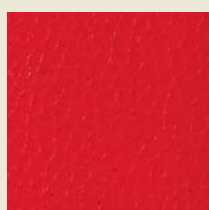

fire red

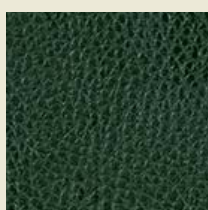

green

## DIFFUSER COLOURS



white



warm white



white canopy

## PL SKI 070

kg 6 m<sup>3</sup> 0.33

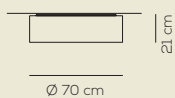

SKIN		Colours (lampshade)	Colours (radial diffuser)	Source
Type	Article			
PL	SKI 070 E27	<b>BC</b> white <b>AG</b> silver <b>AR</b> orange <b>AZ</b> light blue <b>BA</b> ivory white <b>MA</b> brown <b>NE</b> matt black <b>OR</b> gold <b>RS</b> fire red <b>VE</b> green	<b>BC</b> white <b>BW</b> warm white	<b>E27</b> 2 x Max 16W LED or 2 x Max 20W fluo



IP20 +LED

220-240Vac

example composition code PL SKI070E27 BC BC

# Skin

Manuel Vivian

Collezione composta da lampade da soffitto e lampade a sospensione con paralume in ecopelle ignifuga. Disponibile in vari colori e dimensioni. Sorgente luminosa con attacco a vite o a LED integrato dimmerabile.

Collection consisting of ceiling lamps and suspended lamps. The lampshade is covered with flame-retardant eco-leather. Available in several colours and sizes. Screw fitting or built-in dimmable LED light source.

## PL SKI 100

kg 12 m<sup>3</sup> 0.98



### SKIN

Type	Article	Colours (lampshade)	Colours (radial diffuser)	Source
PL	SKI 100 E27	BC white	BC white	E27 3 x Max 16W LED or 3 x Max 23W fluo
		AG silver	BW warm white	
		AR orange		
		AZ light blue		
		BA ivory white		
		MA brown		
		NE matt black		
		OR gold		
		RS fire red		
		VE green		



IP20 +LED

220-240V<sub>AC</sub>

example composition code PL SKI100E27 OR BW

## PL SKI 160

kg 24 m<sup>3</sup> 2.22



### SKIN

Type	Article	Colours (lampshade)	Colours (radial diffuser)	Source
PL	SKI 160 E27	BC white	BC white	E27 5 x Max 16W LED or 5 x Max 23W fluo
		AG silver	BW warm white	
		AR orange		
		AZ light blue		
		BA ivory white		
		MA brown		
		NE matt black		
		OR gold		
		RS fire red		
		VE green		



IP20 +LED

220-240V<sub>AC</sub>

example composition code PL SKI160E27 OR BW

# Skin

Manuel Vivian

Collezione composta da lampade da soffitto e lampade a sospensione con paralume in ecopelle ignifuga. Disponibile in vari colori e dimensioni. Sorgente luminosa con attacco a vite o a LED integrato dimmerabile.

*Collection consisting of ceiling lamps and suspended lamps. The lampshade is covered with flame-retardant eco-leather. Available in several colours and sizes. Screw fitting or built-in dimmable LED light source.*

## SP SKI 070

kg 10 m<sup>3</sup> 0.33

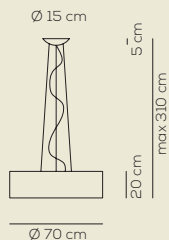

**SKIN** / con illuminazione verso alto e basso / with upward and downward lighting

Type	Article	Colours (lampshade)	Colours (radial diffuser)	Source
SP	SKI 070 E27	BC white	BC white	E27 4 x Max 16W LED or 4 x Max 20W fluo
		AG silver	BW warm white	
		AR orange		
		AZ light blue		
		BA ivory white		
		MA brown		
		NE matt black		
		OR gold		
		RS fire red		
		VE green		

CE IP20 +LED 220-240V<sub>AC</sub>

example composition code SP SKI070E27 MA BW

# Skin

Manuel Vivian

Collezione composta da lampade da soffitto e lampade a sospensione con paralume in ecopelle ignifuga. Disponibile in vari colori e dimensioni. Sorgente luminosa con attacco a vite o a LED integrato dimmerabile.

Collection consisting of ceiling lamps and suspended lamps. The lampshade is covered with flame-retardant eco-leather. Available in several colours and sizes. Screw fitting or built-in dimmable LED light source.

## SP SKI 100

kg 15 m³ 1.08

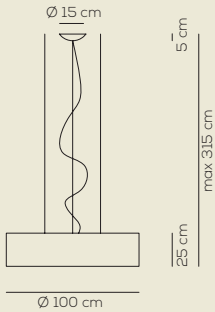

SKIN / con illuminazione verso alto e basso / with upward and downward lighting

Type	Article	Colours (lampshade)	Colours (radial diffuser)	Source
SP	SKI 100 E27	BC white	BC white	E27 6 x Max 16W LED or 6 x Max 20W fluo
		AG silver	BW warm white	
		AR orange		
		AZ light blue		
		BA ivory white		
		MA brown		
		NE matt black		
		OR gold		
		RS fire red		
		VE green		

CE IP20 +LED 220-240VAc

example composition code SP SKI100E27 MA BW

## SP SKI 100 LED

SKIN / con illuminazione verso alto e basso / with upward and downward lighting / DRIVER INCLUDED

Type	Article	Colours (lampshade)	Colours (radial diffuser)	Source
SP	SKI 100 LED	BC white	BC white	LED 98W - diffused beam 3000K*, 4000K
		AG silver	BW warm white	
		AR orange		
		AZ light blue		
		BA ivory white		
		MA brown		
		NE matt black		
		OR gold		
		RS fire red		
		VE green		

CE IP20 CRI90 LED ~10719 lm\* 109 lm/W\*

110-240VAc

example composition code SP SKI100LED BC BW

# Skin

Manuel Vivian

Collezione composta da lampade da soffitto e lampade a sospensione con paralume in ecopelle ignifuga. Disponibile in vari colori e dimensioni. Sorgente luminosa con attacco a vite o a LED integrato dimmerabile.

Collection consisting of ceiling lamps and suspended lamps. The lampshade is covered with flame-retardant eco-leather. Available in several colours and sizes. Screw fitting or built-in dimmable LED light source.

## SP SKI 160

kg 23 m<sup>3</sup> 2.15

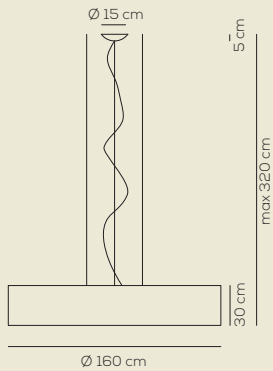

SKIN / con illuminazione verso alto e basso / with upward and downward lighting

Type	Article	Colours (lampshade)	Colours (radial diffuser)	Source
SP	SKI 160 E27	BC white AG silver AR orange AZ light blue BA ivory white MA brown NE matt black OR gold RS fire red VE green	BC white BW warm white	E27 6 x Max 16W LED or 6 x Max 20W fluo

CE IP20 +LED 220-240V<sub>AC</sub>

example composition code SP SKI160E27 MA BW

## SP SKI 160 LED

SKIN / con illuminazione verso alto e basso / with upward and downward lighting / DRIVER INCLUDED

Type	Article	Colours (lampshade)	Colours (radial diffuser)	Source
SP	SKI 160 LED	BC white AG silver AR orange AZ light blue BA ivory white MA brown NE matt black OR gold RS fire red VE green	BC white BW warm white	LED 98W - diffused beam 3000K*, 4000K

CE IP20 CRI90 LED ~10719 lm\* 109 lm/W\*

110-240V<sub>AC</sub>

example composition code SP SKI160LED BA BW

# Skirt

Manuel Vivian

Collezione di lampade da soffitto, a sospensione e da tavolo con paralume in tessuto ignifugato TREVIRA® CS. Disponibile in varie dimensioni e colori, anche con tessuto esterno retato nero.

Collection of ceiling, suspended and table lamps in flame-retardant TREVIRA®CS fabric, available in several sizes and colours. The fabric can also come in a double-layer version with an exterior black net fabric.

## COLOURS

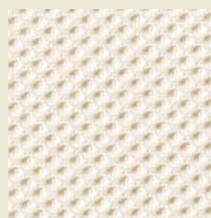

white

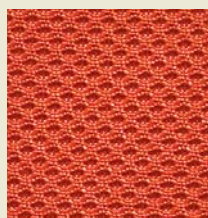

orange



light blue



blue

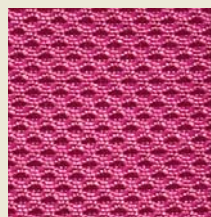

fuchsia

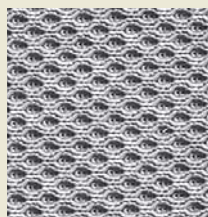

light grey



brown

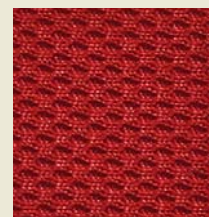

red



light green



black net over a white fabric



white canopy

## PL SKR 070

kg 5.5 m<sup>3</sup> 0.43

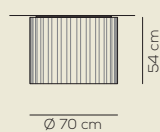

SKIRT / diffusore INCLUSO / diffuser INCLUDED

Type	Article	Exterior Net	Fabric Colours	Source
PL	SKR 070 E27	NE black net XX no black net	BC white AR orange AZ light blue BL blue FU fuchsia GR light grey MA brown RS red VE light green	E27 1 x Max 16W LED or 1 x Max 70W halo



IP20 +LED

220-240Vac

example composition code PL SKR070E27 XX GR

# Skirt

Manuel Vivian

Collezione di lampade da soffitto, a sospensione e da tavolo con paralume in tessuto ignifugato TREVIRA® CS. Disponibile in varie dimensioni e colori, anche con tessuto esterno retato nero.

Collection of ceiling, suspended and table lamps in flame-retardant TREVIRA®CS fabric, available in several sizes and colours. The fabric can also come in a double-layer version with an exterior black net fabric.

## PL SKR 100

kg 10 m<sup>3</sup> 1.06



SKIRT / diffusore INCLUSO / diffuser INCLUDED

Type	Article	Exterior Net	Fabric Colours	Source
PL	SKR 100 E27	NE black net	BC white	E27 3 x Max 16W LED or 3 x Max 70W halo
		XX no black net	AR orange	
			AZ light blue	
			BL blue	
			FU fuchsia	
			GR light grey	
			MA brown	
			RS red	
			VE light green	

CE IP20 +LED 220-240VAc

example composition code PL SKR100E27 NE BC

## PL SKR 150

kg 25 m<sup>3</sup> 2.54

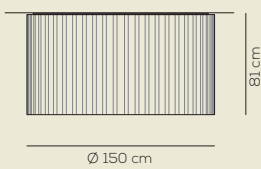

SKIRT / diffusore INCLUSO / diffuser INCLUDED

Type	Article	Exterior Net	Fabric Colours	Source
PL	SKR 150 E27	NE black net	BC white	E27 4 x Max 16W LED or 4 x Max 70W halo
		XX no black net	AR orange	
			AZ light blue	
			BL blue	
			FU fuchsia	
			GR light grey	
			MA brown	
			RS red	
			VE light green	

CE IP20 +LED 220-240VAc

example composition code PL SKR150E27 XX RS

# Skirt

Manuel Vivian

Collezione di lampade da soffitto, a sospensione e da tavolo con paralume in tessuto ignifugato TREVIRA® CS. Disponibile in varie dimensioni e colori, anche con tessuto esterno retato nero.

Collection of ceiling, suspended and table lamps in flame-retardant TREVIRA®CS fabric, available in several sizes and colours. The fabric can also come in a double-layer version with an exterior black net fabric.

## PL SK 100 2

kg 18 m³ 1.06

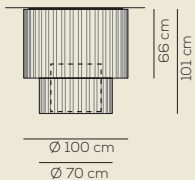

SKIRT / diffusore INCLUSO / diffuser INCLUDED

Type	Article	Exterior Net	Fabric Colours	Source
PL	SK 100 2 E27	NE black net	BC white	E27 3 x Max 16W LED or 3 x Max 70W halo
		XX no black net	AR orange	
			AZ light blue	
			BL blue	
			FU fuchsia	
			GR light grey	
			MA brown	
			RS red	
			VE light green	



IP20 +LED

220-240V<sub>AC</sub>

example composition code PL SK1002E27 XX RS

## PL SK 150 2

kg 30 m³ 2,54

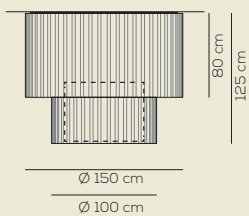

SKIRT / diffusore INCLUSO / diffuser INCLUDED

Type	Article	Exterior Net	Fabric Colours	Source
PL	SK 150 2 E27	NE black net	BC white	E27 4 x Max 16W LED or 4 x Max 70W halo
		XX no black net	AR orange	
			AZ light blue	
			BL blue	
			FU fuchsia	
			GR light grey	
			MA brown	
			RS red	
			VE light green	



IP20 +LED

220-240V<sub>AC</sub>

example composition code PL SK1502E27 XX RS



# Skirt

Manuel Vivian

Collezione di lampade da soffitto, a sospensione e da tavolo con paralume in tessuto ignifugato TREVIRA® CS. Disponibile in varie dimensioni e colori, anche con tessuto esterno retato nero.

Collection of ceiling, suspended and table lamps in flame-retardant TREVIRA®CS fabric, available in several sizes and colours. The fabric can also come in a double-layer version with an exterior black net fabric.

## SP SKR 050

kg 3.5 m³ 0.13

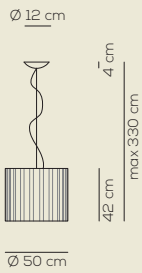

SKIRT / diffusore INCLUSO / diffuser INCLUDED

Type	Article	Exterior Net	Fabric Colours	Source
SP	SKR 050 E27	NE black net	BC white	E27 1 x Max 20W LED or 1 x Max 70W halo
		XX no black net	AR orange	
			AZ light blue	
			BL blue	
			FU fuchsia	
			GR light grey	
			MA brown	
			RS red	
			VE light green	



IP20 +LED

220-240V<sub>AC</sub>

example composition code SP SKR050E27 XX RS

## SP SKR 070

kg 6.5 m³ 0.43

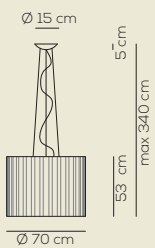

SKIRT / diffusore INCLUSO / diffuser INCLUDED

Type	Article	Exterior Net	Fabric Colours	Source
SP	SKR 070 E27	NE black net	BC white	E27 1 x Max 20W LED or 1 x Max 70W halo
		XX no black net	AR orange	
			AZ light blue	
			BL blue	
			FU fuchsia	
			GR light grey	
			MA brown	
			RS red	
			VE light green	



IP20 +LED

220-240V<sub>AC</sub>

example composition code SP SKR070E27 XX RS

# Skirt

Manuel Vivian

Collezione di lampade da soffitto, a sospensione e da tavolo con paralume in tessuto ignifugato TREVIRA® CS. Disponibile in varie dimensioni e colori, anche con tessuto esterno retato nero.

Collection of ceiling, suspended and table lamps in flame-retardant TREVIRA®CS fabric, available in several sizes and colours. The fabric can also come in a double-layer version with an exterior black net fabric.

## SP SKR 100

kg 12.5 m³ 1.06

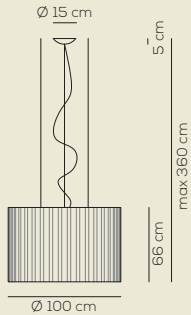

SKIRT / with upward and downward lighting / diffuser INCLUDED / DRIVER INCLUDED

Type	Article	Exterior Net	Fabric Colours	Source
SP	SKR 100 E27	NE black net	BC white	E27 4 x Max 20W LED or 4 x Max 70W halo
		XX no black net	AR orange	
			AZ light blue	
			BL blue	
			FU fuchsia	
			GR light grey	
			MA brown	
			RS red	
			VE light green	



IP20 +LED

220-240V<sub>AC</sub>

example composition code SP SKR100E27 XX RS

## SP SKR 100 LED

SKIRT / with upward and downward lighting / diffuser INCLUDED / DRIVER INCLUDED

Type	Article	Exterior Net	Fabric Colours	Source
SP	SKR 100 LED	NE black net	BC white	LED 98W - diffused beam 3000K*, 4000K
		XX no black net	AR orange	
			AZ light blue	
			BL blue	
			FU fuchsia	
			GR light grey	
			MA brown	
			RS red	
			VE light green	



IP20 CRI90



LED

~10719 lm\* 109 lm/W\*

110-240V<sub>AC</sub>

example composition code SP SKR100LED XX RS

# Skirt

Manuel Vivian

Collezione di lampade da soffitto, a sospensione e da tavolo con paralume in tessuto ignifugato TREVIRA® CS. Disponibile in varie dimensioni e colori, anche con tessuto esterno retato nero.

Collection of ceiling, suspended and table lamps in flame-retardant TREVIRA®CS fabric, available in several sizes and colours. The fabric can also come in a double-layer version with an exterior black net fabric.

## SP SKR 140

kg 11.5 m<sup>3</sup> 0.65

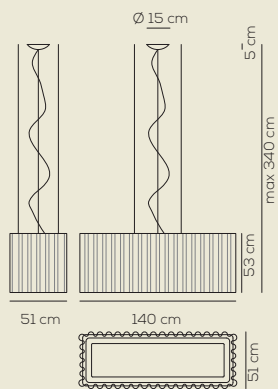

SKIRT / diffusore INCLUSO / diffuser INCLUDED

Type	Article	Exterior Net	Fabric Colours	Source
SP	SKR 140 E27	<b>NE</b> black net  <b>XX</b> no black net	<b>BC</b> white  <b>AR</b> orange  <b>AZ</b> light blue  <b>BL</b> blue  <b>FU</b> fuchsia  <b>GR</b> light grey  <b>MA</b> brown  <b>RS</b> red  <b>VE</b> light green	<b>E27</b> 4 x Max 16W LED or 4 x Max 57W halo



IP20 +LED

220-240V<sub>ac</sub>

example composition code SP SKR140E27 XX RS

# Skirt

Manuel Vivian

Collezione di lampade da soffitto, a sospensione e da tavolo con paralume in tessuto ignifugato TREVIRA® CS. Disponibile in varie dimensioni e colori, anche con tessuto esterno retato nero.

Collection of ceiling, suspended and table lamps in flame-retardant TREVIRA®CS fabric, available in several sizes and colours. The fabric can also come in a double-layer version with an exterior black net fabric.

## SP SKR 150

kg 19 m³ 2.54

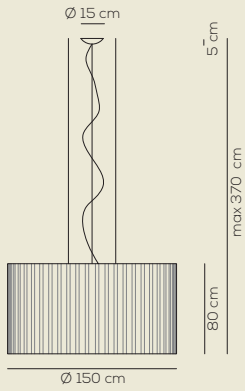

**SKIRT** / diffusore INCLUSO, con illuminazione verso alto e basso / *diffuser INCLUDED, with upward and downward lighting*

Type	Article	Exterior Net	Fabric Colours	Source
SP	SKR 150 E27	NE black net	BC white	E27 4 x Max 16W + 1 x Max 12W LED
		XX no black net	AR orange	
			AZ light blue	4 x Max 70W + 1 x Max 57W halo
			BL blue	
			FU fuchsia	
			GR light grey	
			MA brown	
			RS red	
			VE light green	



IP20 +LED

220-240V<sub>AC</sub>

example composition code SP SKR150E27 XX BC

## SP SKR 150 LED

**SKIRT** / with upward and downward lighting / *diffuser INCLUDED / DRIVER INCLUDED*

Type	Article	Exterior Net	Fabric Colours	Source
SP	SKR 150 LED	NE black net	BC white	LED 98W - diffused beam 3000K*, 4000K
		XX no black net	AR orange	
			AZ light blue	
			BL blue	
			FU fuchsia	
			GR light grey	
			MA brown	
			RS red	
			VE light green	



IP20 CRI90



LED

~10719 lm\* 109 lm/W\*

110-240V<sub>AC</sub>

example composition code SP SKR150LED NE MA

# Skirt

Manuel Vivian

Collezione di lampade da soffitto, a sospensione e da tavolo con paralume in tessuto ignifugato TREVIRA® CS. Disponibile in varie dimensioni e colori, anche con tessuto esterno retato nero.

Collection of ceiling, suspended and table lamps in flame-retardant TREVIRA®CS fabric, available in several sizes and colours. The fabric can also come in a double-layer version with an exterior black net fabric.

## SP SK 100 2

kg 18 m³ 1.06

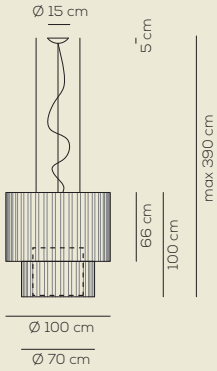

SKIRT / diffusore INCLUSO, con illuminazione verso alto e basso / diffuser INCLUDED, with upward and downward lighting

Type	Article	Exterior Net	Fabric Colours	Source
SP	SK 100 2 E27	NE black net	BC white	E27 4 x Max 20W LED or 4 x Max 70W halo
		XX no black net	AR orange	
			AZ light blue	
			BL blue	
			FU fuchsia	
			GR light grey	
			MA brown	
			RS red	
			VE light green	

CE IP20 +LED 220-240VAc  
example composition code SP SKR150E27 XX BC

## SP SK 100 2 LED

SKIRT / with upward and downward lighting / diffuser INCLUDED / DRIVER INCLUDED

Type	Article	Exterior Net	Fabric Colours	Source
SP	SK 100 2 LED	NE black net	BC white	LED 98W - diffused beam 3000K*, 4000K
		XX no black net	AR orange	
			AZ light blue	
			BL blue	
			FU fuchsia	
			GR light grey	
			MA brown	
			RS red	
			VE light green	

CE IP20 CRI90 LED ~10719 lm\* 109 lm/W\* 110-240VAc  
example composition code SP SK1002LED NE MA

# Skirt

Manuel Vivian

Collezione di lampade da soffitto, a sospensione e da tavolo con paralume in tessuto ignifugato TREVIRA® CS. Disponibile in varie dimensioni e colori, anche con tessuto esterno retato nero.

Collection of ceiling, suspended and table lamps in flame-retardant TREVIRA®CS fabric, available in several sizes and colours. The fabric can also come in a double-layer version with an exterior black net fabric.

## SP SK 150 2

kg 23 m³ 2.54

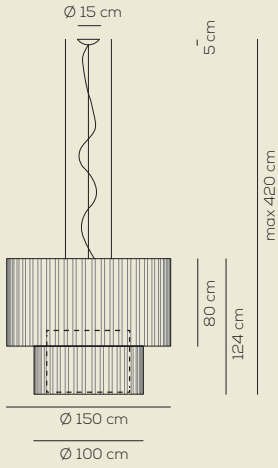

SKIRT / diffuser INCLUDED, with upward and downward lighting

Type	Article	Exterior Net	Fabric Colours	Source
SP	SK 150 2 E27	NE black net	BC white	E27 4 x Max 16W + 1 x Max 12W LED
		XX no black net	AR orange	
			AZ light blue	or 4 x Max 70W + 1 x Max 57W halo
			BL blue	
			FU fuchsia	
			GR light grey	
			MA brown	
			RS red	
			VE light green	



IP20 +LED

220-240V<sub>AC</sub>

example composition code SP SK1502E27 NE MA

## SP SK 150 2 LED

SKIRT / with upward and downward lighting / diffuser INCLUDED / DRIVER INCLUDED

Type	Article	Exterior Net	Fabric Colours	Source
SP	SK 150 2 LED	NE black net	BC white	LED 98W - diffused beam 3000K*, 4000K
		XX no black net	AR orange	
			AZ light blue	
			BL blue	
			FU fuchsia	
			GR light grey	
			MA brown	
			RS red	
			VE light green	



IP20 CRI90



LED

~10719 lm\* 109 lm/W\*

110-240V<sub>AC</sub>

example composition code SP SK1502LED XX BC

# Skirt

Manuel Vivian

Collezione di lampade da soffitto, a sospensione e da tavolo con paralume in tessuto ignifugato TREVIRA® CS. Disponibile in varie dimensioni e colori, anche con tessuto esterno retato nero.

Collection of ceiling, suspended and table lamps in flame-retardant TREVIRA®CS fabric, available in several sizes and colours. The fabric can also come in a double-layer version with an exterior black net fabric.

## LT SKR 050

kg 11 m<sup>3</sup> 0.20

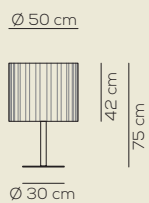

SKIRT				
Type	Article	Exterior Net	Fabric Colours	Source
LT	SKR 050 E27	NE black net	BC white	E27 3 x Max 16W LED or 3 x Max 46W halo
		XX no black net	AR orange	
			AZ light blue	
			BL blue	
			FU fuchsia	
			GR light grey	
			MA brown	
			RS red	
			VE light green	

CE  IP20 +LED

220-240V<sub>AC</sub>

example composition code LT SKR050E27 XX GR

# Spillray

Manuel Vivian

Collezione composta da lampade da parete, lampade da soffitto ad incasso e lampade a sospensione in vetro con montatura in metallo cromato. Disponibile in vari colori e dimensioni. Sorgente luminosa alogena o a LED.

Collection consisting of wall lamps, recessed ceiling lamps and suspended lamps. The diffusers are made of glass with chrome-plated metal frame. Available in several colours and sizes. Halo or LED light source.

## COLOURS



crystal



red



grey

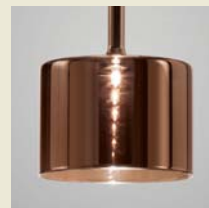

metallic bronze

## CANOPIES



monopoint canopy

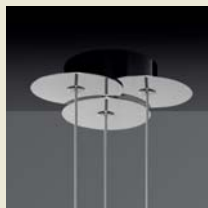

3 lights canopy

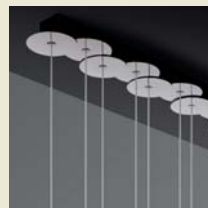

linear multipoint canopy

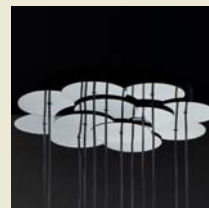

circular multipoint canopy

## RECESSED VERSION



suspension lamp



ceiling lamp

## AP SPILLR

kg 1.2 m³ 0.03

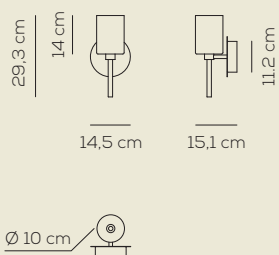

### SPILLRAY

Type	Article	Colours	Finish	Source
AP	SPILLR	CS crystal	CR chrome	<b>12V (••)</b> G41xMax 20W 12VAc halo <b>included</b>
		RS red		<b>G4L (•)</b> G41xMax 1,5W 12Vdc LED <b>included</b> - only LED bulb
		GR grey		

Gli articoli in rosso sono disponibili solo fino ad esaurimento scorte. Articles in red are available until sold out

example composition code AP SPILLR RS CR G4L

optional for more info see page 306

	LAMPADINABISP.20W	20W G4 halogen bulb 12V - 3000K
	LAMPG41,5WL3001	1,5W G4 LED bulb - 3000K



# Spillray

Manuel Vivian

Collezione composta da lampade da parete, lampade da soffitto ad incasso e lampade a sospensione in vetro con montatura in metallo cromato. Disponibile in vari colori e dimensioni. Sorgente luminosa alogena o a LED.

Collection consisting of wall lamps, recessed ceiling lamps and suspended lamps. The diffusers are made of glass with chrome-plated metal frame. Available in several colours and sizes. Halo or LED light source.

## PL SPIL P I (RECESSED)

kg 0.7 m<sup>3</sup> 0.02

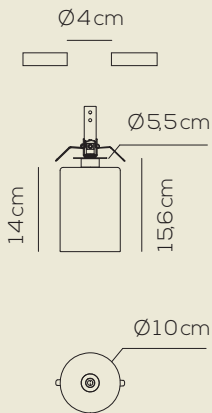

SPILLRAY / TRANSFORMER OR DRIVER NOT INCLUDED

Type	Article	Colours	Finish	Source
PL	SPIL P I	CS crystal	CR chrome	<b>12V (••)</b> G4 1xMax 20W 12Vac halo <b>included</b>
		RS red		<b>G4L (•)</b> G4 1xMax 1,5W 12Vdc LED <b>included</b> - <b>only LED bulb</b>
		GR grey		

Gli articoli in rosso sono disponibili solo fino ad esaurimento scorte. Articles in red are available until sold out



foro - hole  $\varnothing$  4 cm / profondità min - min depth 10 cm

example composition code PL SPILPI CS CR 12V

optional for more info see page 306 & 309

	TR60PRIMULA	(12V) dimmable phase cut 60W transformer
	CEDMWC00200	(G4L) standard driver - Max 8W
	CEDMWC00201	(G4L) standard driver - Max 12W
	LAMPADINABISP.20W	20W G4 halogen bulb 12V - 3000K
	LAMPG41,5WL3001	1,5W G4 LED bulb - 3000K

## PL SPIL M I (RECESSED)

kg 0.6 m<sup>3</sup> 0.02

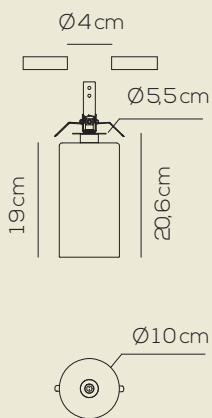

SPILLRAY / TRANSFORMER OR DRIVER NOT INCLUDED

Type	Article	Colours	Finish	Source
PL	SPIL M I	CS crystal	CR chrome	<b>12V (••)</b> G4 1xMax 20W 12Vac halo <b>included</b>
		RS red		<b>G4L (•)</b> G4 1xMax 1,5W 12Vdc LED <b>included</b> - <b>only LED bulb</b> not dimmable
		GR grey		

Gli articoli in rosso sono disponibili solo fino ad esaurimento scorte. Articles in red are available until sold out

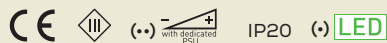

foro - hole  $\varnothing$  4 cm / profondità min - min depth 10 cm

example composition code PL SPILMI CS CR 12V

optional for more info see page 306 & 309

	TR60PRIMULA	(12V) dimmable phase cut 60W transformer
	CEDMWC00200	(G4L) standard driver - Max 8W
	CEDMWC00201	(G4L) standard driver - Max 12W
	LAMPADINABISP.20W	20W G4 halogen bulb 12V - 3000K
	LAMPG41,5WL3001	1,5W G4 LED bulb - 3000K

# Spillray

Manuel Vivian

Collezione composta da lampade da parete, lampade da soffitto ad incasso e lampade a sospensione in vetro con montatura in metallo cromato. Disponibile in vari colori e dimensioni. Sorgente luminosa alogena o a LED.

Collection consisting of wall lamps, recessed ceiling lamps and suspended lamps. The diffusers are made of glass with chrome-plated metal frame. Available in several colours and sizes. Halo or LED light source.

## PL SPIL G I (RECESSED)

kg 0.6 m³ 0.023

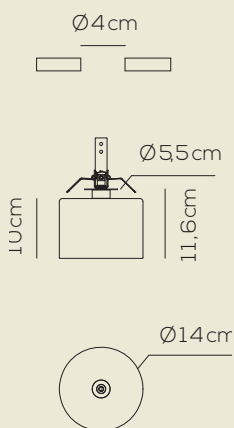

SPILLRAY / TRANSFORMER OR DRIVER NOT INCLUDED

Type	Article	Colours	Finish	Source
PL	SPIL G I	CS crystal	CR chrome	<b>12V (••)</b> G4 1xMax 20W 12Vac halo <b>included</b>
		RS red		<b>G4L (•)</b> G4 1xMax 1,5W 12Vdc LED <b>included</b> - <b>only</b> LED bulb
		GR grey		

Gli articoli in rosso sono disponibili solo fino ad esaurimento scorte. Articles in red are available until sold out

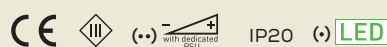

foro - hole  $\varnothing$  4 cm / profondità min - min depth 10 cm

example composition code PL SPILGI CS CR 12V

optional for more info see page 306 & 309

	TR60PRIMULA	(12V) dimmable phase cut 60W transformer
	CEDMWC00200	(G4L) standard driver - Max 8W
	CEDMWC00201	(G4L) standard driver - Max 12W
	LAMPADINABISP.20W	20W G4 halogen bulb 12V - 3000K
	LAMPG41,5WL3001	1,5W G4 LED bulb - 3000K

# Spillray

Manuel Vivian

Collezione composta da lampade da parete, lampade da soffitto ad incasso e lampade a sospensione in vetro con montatura in metallo cromato. Disponibile in vari colori e dimensioni. Sorgente luminosa alogena o a LED.

Collection consisting of wall lamps, recessed ceiling lamps and suspended lamps. The diffusers are made of glass with chrome-plated metal frame. Available in several colours and sizes. Halo or LED light source.

## SP SPILL P

kg 1.2 m<sup>3</sup> 0.02

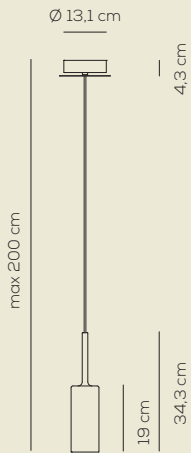

### SPILLRAY

Type	Article	Colours	Finish	Source
SP	SPILL P	CS crystal	CR chrome	<b>12V (••)</b> G4 1xMax 20W 12VAc halo <b>included</b>
		RS red		<b>G4L (•)</b> G4 1xMax 1,5W 12Vdc LED <b>included</b> - <b>only</b> LED bulb
		GR grey		
		BR metallic bronze		

Gli articoli in rosso sono disponibili solo fino ad esaurimento scorte. Articles in red are available until sold out

IP20 (••) 220-240V<sub>AC</sub> (•) LED 90-264V<sub>AC</sub>  
 example composition code SP SPILLP BR CR 12V

optional for more info see page 306

	LAMPADINABISP.20W	20W G4 halogen bulb 12V - 3000K
	LAMPG41,5WL3001	1,5W G4 LED bulb - 3000K

## SP SPIL P I (RECESSED)

kg 1.2 m<sup>3</sup> 0.03

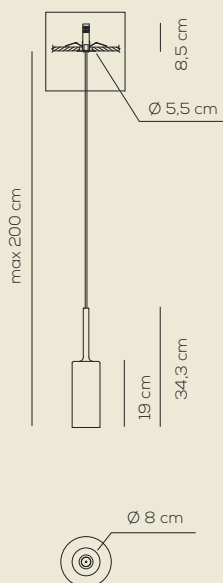

### SPILLRAY / TRANSFORMER OR DRIVER NOT INCLUDED

Type	Article	Colours	Finish	Source
SP	SPIL P I	CS crystal	CR chrome	<b>12V (••)</b> G4 1xMax 20W 12VAc halo <b>included</b>
		RS red		<b>G4L (•)</b> G4 1xMax 1,5W 12Vdc LED <b>included</b> - <b>only</b> LED bulb
		GR grey		
		BR metallic bronze		

Gli articoli in rosso sono disponibili solo fino ad esaurimento scorte. Articles in red are available until sold out

IP20 (•) LED  
 foro - hole Ø 4 cm / profondità min - min depth 10 cm  
 example composition code SP SPILPI BR CR 12V

optional for more info see page 306 & 309

	TR60PRIMULA	(12V) dimmable phase cut 60W transformer
	CEDMWC00200	(G4L) standard driver - Max 8W
	CEDMWC00201	(G4L) standard driver - Max 12W
	LAMPADINABISP.20W	20W G4 halogen bulb 12V - 3000K
	LAMPG41,5WL3001	1,5W G4 LED bulb - 3000K

# Spillray

Manuel Vivian

Collezione composta da lampade da parete, lampade da soffitto ad incasso e lampade a sospensione in vetro con montatura in metallo cromato. Disponibile in vari colori e dimensioni. Sorgente luminosa alogena o a LED.

Collection consisting of wall lamps, recessed ceiling lamps and suspended lamps. The diffusers are made of glass with chrome-plated metal frame. Available in several colours and sizes. Halo or LED light source.

## SP SPILL M

kg 1.4 m<sup>3</sup> 0.05

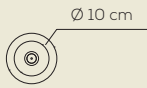
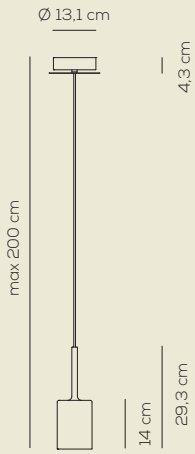

### SPILLRAY

Type	Article	Colours	Finish	Source
SP	SPILL M	CS crystal	CR chrome	<b>12V (••)</b> G4 1xMax 20W 12Vac halo <b>included</b>
		RS red		<b>G4L (•)</b> G4 1xMax 1,5W 12Vdc LED <b>included</b> - <b>only</b> LED bulb
		GR grey		
		BR metallic bronze		

Gli articoli in rosso sono disponibili solo fino ad esaurimento scorte. Articles in red are available until sold out

IP20 (••) 220-240V<sub>AC</sub> (•) LED 90-264V<sub>AC</sub>  
 example composition code SP SPILLM BR CR G4L

optional for more info see page 306

	LAMPADINABISP.20W	20W G4 halogen bulb 12V - 3000K
	LAMPG41,5WL3001	1,5W G4 LED bulb - 3000K

## SP SPIL M I (RECESSED)

kg 1.4 m<sup>3</sup> 0.05

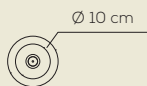
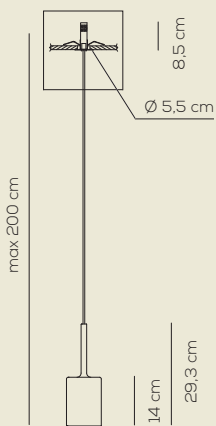

### SPILLRAY / TRANSFORMER OR DRIVER NOT INCLUDED

Type	Article	Colours	Finish	Source
SP	SPIL M I	CS crystal	CR chrome	<b>12V (••)</b> G4 1xMax 20W 12Vac halo <b>included</b>
		RS red		<b>G4L (•)</b> G4 1xMax 1,5W 12Vdc LED <b>included</b> - <b>only</b> LED bulb
		GR grey		
		BR metallic bronze		

Gli articoli in rosso sono disponibili solo fino ad esaurimento scorte. Articles in red are available until sold out

IP20 (•) LED  
 foro - hole Ø 4 cm / profondità min - min depth 10 cm  
 example composition code SP SPILMI BR CR 12V

optional for more info see page 306 & 309

	TR60PRIMULA	(12V) dimmable phase cut 60W transformer
	CEDMWC00200	(G4L) standard driver - Max 8W
	CEDMWC00201	(G4L) standard driver - Max 12W
	LAMPADINABISP.20W	20W G4 halogen bulb 12V - 3000K
	LAMPG41,5WL3001	1,5W G4 LED bulb - 3000K

# Spillray

Manuel Vivian

Collezione composta da lampade da parete, lampade da soffitto ad incasso e lampade a sospensione in vetro con montatura in metallo cromato. Disponibile in vari colori e dimensioni. Sorgente luminosa alogena o a LED.

Collection consisting of wall lamps, recessed ceiling lamps and suspended lamps. The diffusers are made of glass with chrome-plated metal frame. Available in several colours and sizes. Halo or LED light source.

## SP SPILL G

kg 1.6 m<sup>3</sup> 0.05

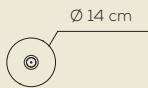
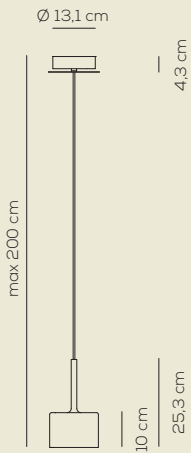

### SPILLRAY

Type	Article	Colours	Finish	Source
SP	SPILL G	CS crystal	CR chrome	<b>12V (••)</b> G4 1xMax 20W 12VAc halo <b>included</b>
		RS red		<b>G4L (•)</b> G4 1xMax 1,5W 12Vdc LED <b>included</b> - <b>only</b> LED bulb
		GR grey		
		BR metallic bronze		

Gli articoli in rosso sono disponibili solo fino ad esaurimento scorte. Articles in red are available until sold out

IP20 (••) 220-240VAc (•) **LED** 90-264VAc  
 example composition code SP SPILLG BR CR 12V

optional for more info see page 306

	LAMPADINABISP.20W	20W G4 halogen bulb 12V - 3000K
	LAMPG41,5WL3001	1,5W G4 LED bulb - 3000K

## SP SPIL G I (RECESSED)

kg 1.6 m<sup>3</sup> 0.05

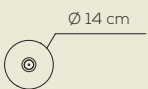
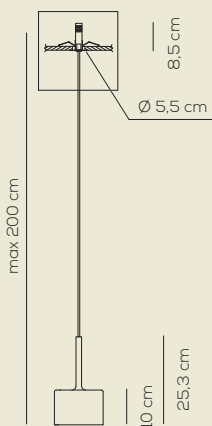

### SPILLRAY / TRANSFORMER OR DRIVER NOT INCLUDED

Type	Article	Colours	Finish	Source
SP	SPIL G I	CS crystal	CR chrome	<b>12V (••)</b> G4 1xMax 20W 12VAc halo <b>included</b>
		RS red		<b>G4L (•)</b> G4 1xMax 1,5W 12Vdc LED <b>included</b> - <b>only</b> LED bulb
		GR grey		
		BR metallic bronze		

Gli articoli in rosso sono disponibili solo fino ad esaurimento scorte. Articles in red are available until sold out

IP20 (•) **LED**  
 foro - hole Ø 4 cm / profondità min - min depth 10 cm  
 example composition code SP SPILGI BR CR G4L

optional for more info see page 306 & 309

	TR60PRIMULA	(12V) dimmable phase cut 60W transformer
	CEDMWC00200	(G4L) standard driver - Max 8W
	CEDMWC00201	(G4L) standard driver - Max 12W
	LAMPADINABISP.20W	20W G4 halogen bulb 12V - 3000K
	LAMPG41,5WL3001	1,5W G4 LED bulb - 3000K

# Spillray

Manuel Vivian

Collezione composta da lampade da parete, lampade da soffitto ad incasso e lampade a sospensione in vetro con montatura in metallo cromato. Disponibile in vari colori e dimensioni. Sorgente luminosa alogena o a LED.

Collection consisting of wall lamps, recessed ceiling lamps and suspended lamps. The diffusers are made of glass with chrome-plated metal frame. Available in several colours and sizes. Halo or LED light source.

## SP SPILL 3

kg 1.8 m<sup>3</sup> 0.05

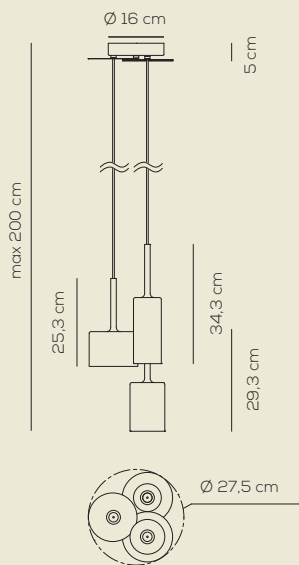

### SPILLRAY

Type	Article	Colours	Finish	Source
SP	SPILL 3	CS crystal	CR chrome	<b>12V (••)</b> G4 3xMax 20W 12Vac halo <b>included</b>
		RS red		<b>G4L (•)</b> G4 3xMax 1,5W 12Vdc LED <b>included</b> - <b>only</b> LED bulb
		GR grey		
		BR metallic bronze		

Gli articoli in rosso sono disponibili solo fino ad esaurimento scorte. Articles in red are available until sold out

IP20 (••) 220-240VAC (•) **LED** 90-264VAC  
 example composition code SP SPILL3 BR CR 12V

optional for more info see page 306

	LAMPADINABISP.20W	20W G4 halogen bulb 12V - 3000K
	LAMPG41,5WL3001	1,5W G4 LED bulb - 3000K

## SP SPILL 6

kg 4.5 m<sup>3</sup> 0.13

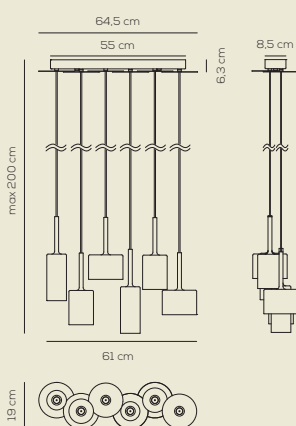

### SPILLRAY

Type	Article	Colours	Finish	Source
SP	SPILL 6	CS crystal	CR chrome	<b>12V (••)</b> G4 6xMax 20W 12Vac halo <b>included</b>
		RS red		<b>G4L (•)</b> G4 6xMax 1,5W 12Vdc LED <b>included</b> - <b>only</b> LED bulb
		GR grey		
		BR metallic bronze		

Gli articoli in rosso sono disponibili solo fino ad esaurimento scorte. Articles in red are available until sold out

IP20 (••) 220-240VAC (•) **LED** 90-264VAC  
 example composition code SP SPILL6 BR CR 12V

optional for more info see page 306

	LAMPADINABISP.20W	20W G4 halogen bulb 12V - 3000K
	LAMPG41,5WL3001	1,5W G4 LED bulb - 3000K

# Spillray

Manuel Vivian

Collezione composta da lampade da parete, lampade da soffitto ad incasso e lampade a sospensione in vetro con montatura in metallo cromato. Disponibile in vari colori e dimensioni. Sorgente luminosa alogena o a LED.

Collection consisting of wall lamps, recessed ceiling lamps and suspended lamps. The diffusers are made of glass with chrome-plated metal frame. Available in several colours and sizes. Halo or LED light source.

## SP SPIL 10

kg 7 m<sup>3</sup> 0.22

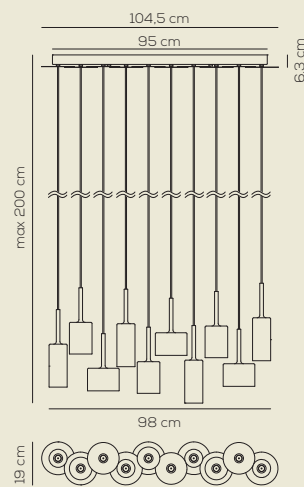

### SPILLRAY

Type	Article	Colours	Finish	Source
SP	SPIL 10	CS crystal	CR chrome	<b>12V (••)</b> G4 10xMax 20W 12V <sub>ac</sub> halo <b>included</b>
		RS red		<b>G4L (•)</b> G4 10xMax 1,5W 12V <sub>dc</sub> LED <b>included</b> - only LED bulb
		GR grey		
		BR metallic bronze		

Gli articoli in rosso sono disponibili solo fino ad esaurimento scorte. Articles in red are available until sold out

IP20 (••) 220-240V<sub>ac</sub> (•) **LED** 90-264V<sub>ac</sub>  
 example composition code **SP SPIL10 BR CR 12V**

optional for more info see page 306

	LAMPADINABISP.20W	20W G4 halogen bulb 12V - 3000K
	LAMPG41,5WL3001	1,5W G4 LED bulb - 3000K

## SP SPIL 12

kg 9 m<sup>3</sup> 0.13

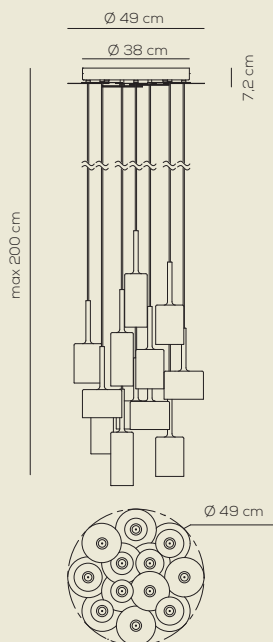

### SPILLRAY

Type	Article	Colours	Finish	Source
SP	SPIL 12	CS crystal	CR chrome	<b>12V (••)</b> G4 12xMax 20W 12V <sub>ac</sub> halo <b>included</b>
		RS red		<b>G4L (•)</b> G4 12xMax 1,5W 12V <sub>dc</sub> LED <b>included</b> - only LED bulb
		GR grey		
		BR metallic bronze		

Gli articoli in rosso sono disponibili solo fino ad esaurimento scorte. Articles in red are available until sold out

IP20 (••) 220-240V<sub>ac</sub> (•) **LED** 90-264V<sub>ac</sub>  
 example composition code **SP SPIL12 BR CR 12V**

optional for more info see page 306

	LAMPADINABISP.20W	20W G4 halogen bulb 12V - 3000K
	LAMPG41,5WL3001	1,5W G4 LED bulb - 3000K

# Spillray

Manuel Vivian

Collezione composta da lampade da parete, lampade da soffitto ad incasso e lampade a sospensione in vetro con montatura in metallo cromato. Disponibile in vari colori e dimensioni. Sorgente luminosa alogena o a LED.

Collection consisting of wall lamps, recessed ceiling lamps and suspended lamps. The diffusers are made of glass with chrome-plated metal frame. Available in several colours and sizes. Halo or LED light source.

## SP SPIL 20

kg 22 m<sup>3</sup> 1.08

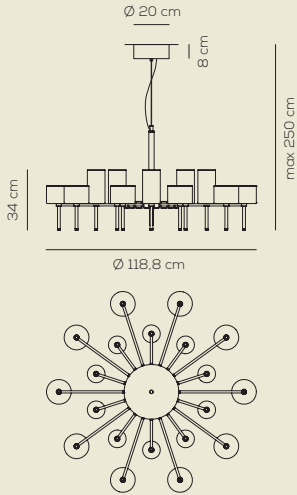

### SPILLRAY

Type	Article	Colours	Finish	Source
SP	SPIL 20	CS crystal	CR chrome	<b>12V (••)</b> G4 20 x Max 10W halo included
		RS red		<b>G4L (•)</b> G4 20xMax 1,5W 12Vdc LED included - only LED bulb
		GR grey		

Gli articoli in rosso sono disponibili solo fino ad esaurimento scorte. Articles in red are available until sold out

220-240VAC (•) **LED** 90-264VAC  
 example composition code **SP SPIL20 RS CR 12V**

optional for more info see page 306

- LAMPADINABISP.10W 10W G4 halogen bulb 12V - 3000K
- LAMPG41,5WL3001 1,5W G4 LED bulb - 3000K

## SP SPIL 26

kg 23.5 m<sup>3</sup> 0.86

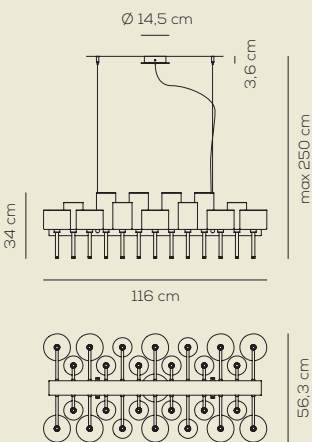

### SPILLRAY

Type	Article	Colours	Finish	Source
SP	SPIL 26	CS crystal	CR chrome	<b>12V (••)</b> G4 26 x Max 10W halo included
		RS red		<b>G4L (•)</b> G4 26xMax 1,5W 12Vdc LED included - only LED bulb
		GR grey		

Gli articoli in rosso sono disponibili solo fino ad esaurimento scorte. Articles in red are available until sold out

220-240VAC (•) **LED** 90-264VAC  
 example composition code **SP SPIL26 RS CR 12V**

optional for more info see page 306

- LAMPADINABISP.10W 10W G4 halogen bulb 12V - 3000K
- LAMPG41,5WL3001 1,5W G4 LED bulb - 3000K

## SP SPIL 30

kg 31 m<sup>3</sup> 1.31

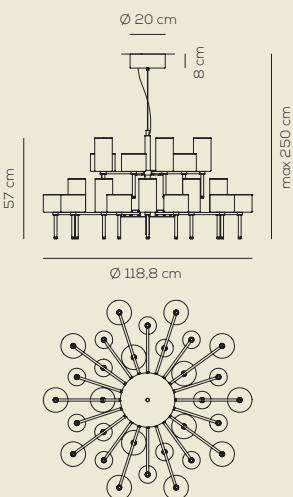

### SPILLRAY

Type	Article	Colours	Finish	Source
SP	SPIL 30	CS crystal	CR chrome	<b>12V (••)</b> G4 30 x Max 10W halo included
		RS red		<b>G4L (•)</b> G4 30xMax 1,5W 12Vdc LED included - only LED bulb
		GR grey		

Gli articoli in rosso sono disponibili solo fino ad esaurimento scorte. Articles in red are available until sold out

220-240VAC (•) **LED** 90-264VAC  
 example composition code **SP SPIL30 RS CR 12V**

optional for more info see page 306

- LAMPADINABISP.10W 10W G4 halogen bulb 12V - 3000K
- LAMPG41,5WL3001 1,5W G4 LED bulb - 3000K



# Stilla

Manuel Vivian

Lampada a sospensione in alluminio in due colori. Disponibile anche nella versione ad incasso. Sorgente luminosa a LED integrato.

Aluminium suspended lamp, also in a recessed version. Available in two colours. Built-in LED light source.

## COLOURS

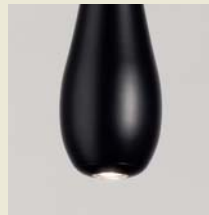

black



black recessed version



white



white with canopy

## STILLA SUSPENSION

kg 1.07 m<sup>3</sup> 0.0073

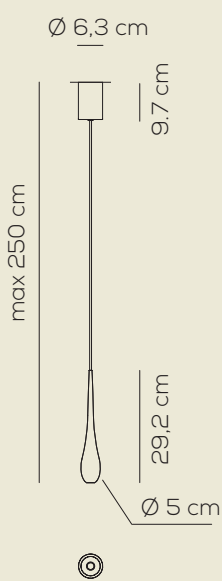

### STILLA / LED 8,7W / DRIVER INCLUDED

Zone	Type	Article	System compatibility	Finish	LED colour temperature	Beam options
E	2	100	1 monopoint canopy version	04 matt black  07 white 9016	1 3000 K	2 47°  3 60°

Gli articoli in rosso sono disponibili solo fino ad esaurimento scorte. Articles in red are available until sold out

CE IP20 CRI80 LED ~780 lm 90lm/W 220-240Vac

example composition code E 2 100 1 07 1 2

optional:

E000700800 Kit decentramento nero Ø 2,2 x 2 cm. / Black decentralization kit Ø 2,2 x 2 cm.

E000700900 Kit decentramento bianco Ø 2,2 x 2 cm. / White decentralization kit Ø 2,2 x 2 cm.

### STILLA RECESSED / LED 6,5W / 350mA / DRIVER NOT INCLUDED

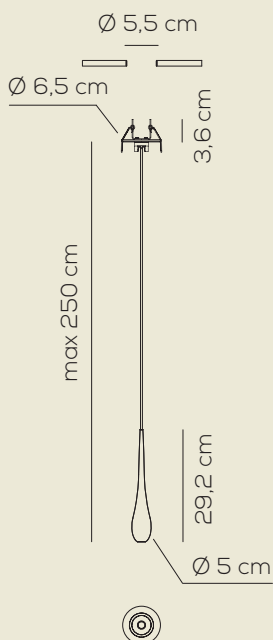

Zone	Type	Article	System compatibility	Finish	LED colour temperature	Beam options
E	2	100	4 recessed	04 matt black  07 white 9016	1 3000 K	2 47°  3 60°

Gli articoli in rosso sono disponibili solo fino ad esaurimento scorte. Articles in red are available until sold out

CE IP20 CRI80 LED ~780 lm 120lm/W

foro - hole Ø 5,5 cm / profondità min - min depth 10 cm - Collegare in serie. / Wire in series.

example composition code E 2 100 4 04 1 3

optional driver for more info see page 308

E000700800 Kit decentramento nero Ø 2,2 x 2 cm. / Black decentralization kit Ø 2,2 x 2 cm.

E000700900 Kit decentramento bianco Ø 2,2 x 2 cm. / White decentralization kit Ø 2,2 x 2 cm.

CEDLTC00100 standard 350mA driver - Max 8W

CEDLTC00103 dimmable 1-10V 350mA driver - Max 25W

CEDLTC00104 dimmable DALI 350mA driver - Max 25W

# Stormy

Manuel Vivian

Collezione composta da lampade da soffitto o da parete con struttura metallica e rivestimento in tessuto elasticizzato, sfoderabile e lavabile. Disponibile in vari colori e dimensioni. Sorgente luminosa con attacco a vite.

Collection consisting of ceiling or wall lamps with metal frame and removable, washable elastic fabric covering. Available in several colours and sizes. Screw fitting light source.

## COLOURS



white



ivory

## PL STOR 60

kg 2.5 m<sup>3</sup> 0.07

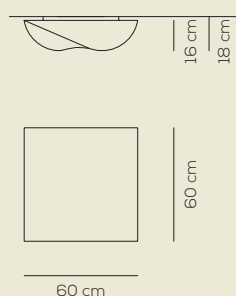

**STORMY** / tessuto INCLUSO - applicazione a soffitto o a parete / *fabric INCLUDED* - application: both as ceiling or wall lamp

Type	Article	Colours	Finish	Source
PL	STOR 60	BC white  AV ivory	XX white metal	E27 2 x Max 16W LED or 2 x Max 70W halo

Gli articoli in rosso sono disponibili solo fino ad esaurimento scorte. Articles in red are available until sold out.

CE IP20 +LED 220-240V<sub>ac</sub>

example composition code PL STOR60 AV XX E27

### TESSUTI SUPPLEMENTARI SU RICHIESTA / ADDITIONAL FABRICS UPON REQUEST:

TSPLSTORMY60BC white

## PL STO 100

kg 4 m<sup>3</sup> 0.22

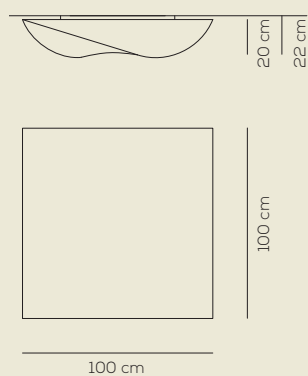

**STORMY** / tessuto INCLUSO - applicazione a soffitto o a parete / *fabric INCLUDED* - application: both as ceiling or wall lamp

Type	Article	Colours	Finish	Source
PL	STO 100	BC white  AV ivory	XX white metal	E27 3 x Max 16W LED or 3 x Max 70W halo

Gli articoli in rosso sono disponibili solo fino ad esaurimento scorte. Articles in red are available until sold out.

CE IP20 +LED 220-240V<sub>ac</sub>

example composition code PL STO100 BC XX E27

### TESSUTI SUPPLEMENTARI SU RICHIESTA / ADDITIONAL FABRICS UPON REQUEST:

TSPLSTORMY100BC white

TSPLSTORMY100AV ivory

# U-light

Timo Ripatti

Collezione composta da lampade da parete, lampade da soffitto e lampade a sospensione in alluminio. Disponibile in due colori e varie dimensioni. Sorgente luminosa a LED integrato dimmerabile.

*Collection consisting of wall lamps, ceiling lamps and suspended lamps in aluminium. Available in two colours and several sizes. Built-in LED dimmable light source.*

## COLOURS



anthracite grey



canopy



rust brow



canopy

## WALL AND CEILING LAMP VERSION



wall or ceiling details



wall or ceiling lamp canopy version

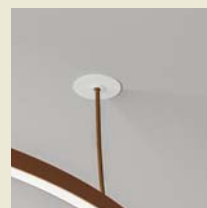

wall or ceiling lamp recessed version

## AP ULI 090

kg 1.3 m<sup>3</sup> 0.09

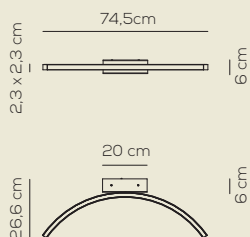

U-LIGHT / downlight or uplight mounting / DRIVER INCLUDED

Type	Article	Colours	Code End	Source
AP	ULI 090 LED	AN anthracite grey RU rust brown	XX	LED 23W - diffused beam <b>3000K*, 2700K</b> other CCT options available upon request.

Gli articoli in rosso sono disponibili solo fino ad esaurimento scorte. *Articles in red are available until sold out.*

~1470 lm\* 64 lm/W\* 100-240VAc  
 example composition code **AP ULI090LED RU XX**

# U-light

Timo Ripatti

Collezione composta da lampade da parete, lampade da soffitto e lampade a sospensione in alluminio. Disponibile in due colori e varie dimensioni. Sorgente luminosa a LED integrato dimmerabile.

Collection consisting of wall lamps, ceiling lamps and suspended lamps in aluminium. Available in two colours and several sizes. Built-in LED dimmable light source.

## PL UL 1 090 h10 cm canopy PL UL 2 090 h25 cm canopy

PL UL 1: kg 5.8 m<sup>3</sup> 0.128  
PL UL 2: kg 6.3 m<sup>3</sup> 0.128

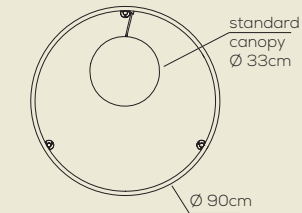

rosone standard / standard canopy

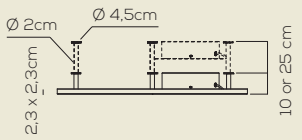

altezze disponibili  
available heights

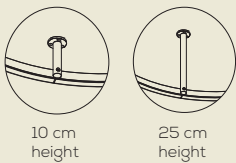

U-LIGHT / h10 cm or h25 cm ceiling lamp with canopy / DRIVER INCLUDED

Type	Article	Colours	Version	Source
PL	UL 1 090 LED (h10 cm)	AN anthracite grey	XX standard canopy	LED 63W - diffused beam <b>3000K*, 2700K</b> other CCT options available upon request.
	UL 2 090 LED (h25 cm)	RU rust brown		

CE IP20 CRI90 LED ~4904 lm\* 78 lm/W\* 100-240Vac

Installazione come plafoniera (downlight o uplight) oppure applique (con illuminazione verso la superficie di installazione).  
Application: both as ceiling (downlight or uplight mounting) or wall lamp (only wallward light).

example composition code PL UL2090LED AN XX

## PL UL 1 090 h10 cm recessed PL UL 2 090 h25 cm recessed

PL UL 1: kg 2.7 m<sup>3</sup> 0.126  
PL UL 2: kg 3.1 m<sup>3</sup> 0.126

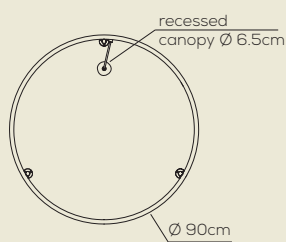

rosone incasso / recessed canopy

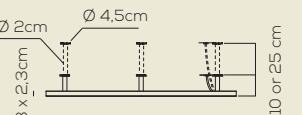

altezze disponibili  
available heights

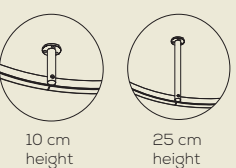

U-LIGHT / h10 cm or h25 cm recessed ceiling lamp / DRIVER NOT INCLUDED

Type	Article	Colours	Version	Source
PL	UL 1 090 LED (h10 cm)	AN anthracite grey	IN recessed canopy	LED 54W - diffused beam <b>3000K*, 2700K</b> 24VDC other CCT options available upon request.
	UL 2 090 LED (h25 cm)	RU rust brown		

CE IP20 CRI90 LED ~4904 lm\* 91 lm/W\* 24Vdc

foro - hole Ø 4,5 cm / profondità min - min depth 10 cm

Installazione come plafoniera (downlight o uplight) oppure applique (con illuminazione verso la superficie di installazione).  
Application: both as ceiling (downlight or uplight mounting) or wall lamp (only wallward light).

example composition code PL UL1090LED RU IN

optional for more info see page 309

	CEDMWC00202	dimmerable 1-10V 24VDC driver max 80W
	CEDMWC00204	dimmerable DALI 24VDC driver max 75W

# U-light

Timo Ripatti

Collezione composta da lampade da parete, lampade da soffitto e lampade a sospensione in alluminio. Disponibile in due colori e varie dimensioni. Sorgente luminosa a LED integrato dimmerabile.

Collection consisting of wall lamps, ceiling lamps and suspended lamps in aluminium. Available in two colours and several sizes. Built-in LED dimmable light source.

## PL UL 1 120 h10 cm canopy PL UL 2 120 h25 cm canopy

PL UL 1: kg 6.6 m<sup>3</sup> 0.180  
PL UL 2: kg 7 m<sup>3</sup> 0.180

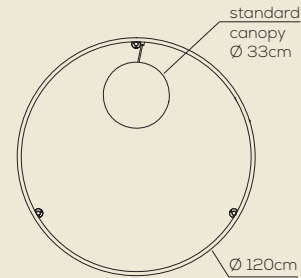

rosone standard / standard canopy

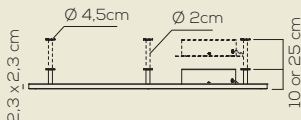

altezze disponibili  
available heights

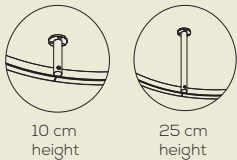

U-LIGHT / h10cm or h25cm ceiling lamp with canopy / DRIVER INCLUDED

Type	Article	Colours	Version	Source
PL	UL 1 120 LED (h10 cm)	AN anthracite grey	XX standard canopy	LED 86W - diffused beam <b>3000K*, 2700K</b> other CCT options available upon request.
	UL 2 120 LED (h25 cm)	RU rust brown		

CE IP20 CRI90 ~7354 lm\* 86 lm/W\* 100-240VAc

Installazione come plafoniera (downlight o uplight) oppure applique (con illuminazione verso la superficie di installazione).  
Application: both as ceiling (downlight or uplight mounting) or wall lamp (only wallward light).

example composition code PL UL1120LED RU XX

## PL UL 1 120 h10 cm recessed PL UL 2 120 h25 cm recessed

PL UL 1: kg 3.2 m<sup>3</sup> 0.150  
PL UL 2: kg 3.6 m<sup>3</sup> 0.150

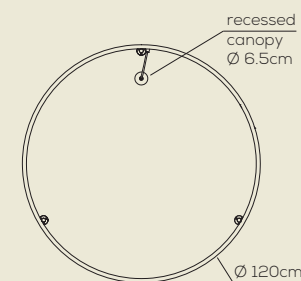

rosone incasso / recessed canopy

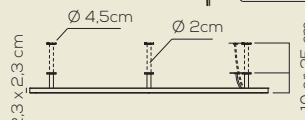

altezze disponibili  
available heights

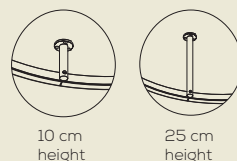

U-LIGHT / h10 cm or h25 cm recessed ceiling lamp / DRIVER NOT INCLUDED

Type	Article	Colours	Version	Source
PL	UL 1 120 LED (h10 cm)	AN anthracite grey	IN recessed canopy	LED 74W - diffused beam <b>3000K*, 2700K</b> 24VDC other CCT options available upon request.
	UL 2 120 LED (h25 cm)	RU rust brown		

CE IP20 CRI90 ~7354 lm\* 99 lm/W\* 24Vdc

foro - hole Ø 4,5 cm / profondità min - min depth 10 cm

Installazione come plafoniera (downlight o uplight) oppure applique (con illuminazione verso la superficie di installazione).  
Application: both as ceiling (downlight or uplight mounting) or wall lamp (only wallward light).

example composition code PL UL2120LED AN IN

optional for more info see page 309

	CEDMWC00203	dimmerable 1-10V 24VDC driver max 100W
	CEDMWC00205	dimmerable DALI 24VDC driver max 100W

# U-light

Timo Ripatti

Collezione composta da lampade da parete, lampade da soffitto e lampade a sospensione in alluminio. Disponibile in due colori e varie dimensioni. Sorgente luminosa a LED integrato dimmerabile.

Collection consisting of wall lamps, ceiling lamps and suspended lamps in aluminium. Available in two colours and several sizes. Built-in LED dimmable light source.

## PL UL 1 160 h10 cm canopy

## PL UL 2 160 h25 cm canopy

PL UL 1: kg 9.2 m<sup>3</sup> 0.310

PL UL 2: kg 9.6 m<sup>3</sup> 0.310

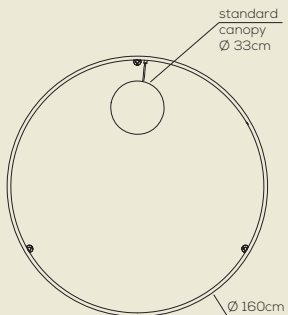

rosone standard / standard canopy

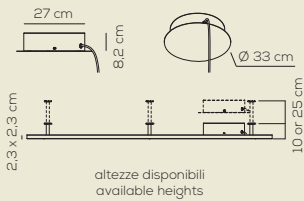

altezze disponibili  
available heights

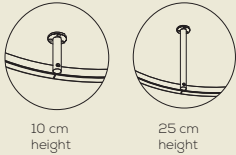

10 cm  
height

25 cm  
height

U-LIGHT / h10 cm or h25 cm ceiling lamp with canopy / DRIVER INCLUDED

Type	Article	Colours	Version	Source
PL	UL 1 160 LED (h10 cm)	AN anthracite grey	XX standard canopy	LED 125W - diffused beam <b>3000K*, 2700K</b> other CCT options available upon request.
	UL 2 160 LED (h25 cm)	RU rust brown		

CE IP20 CRI90 LED ~8575 lm\* 69 lm/W\* 100-240VAC

Installazione come plafoniera (downlight o uplight) oppure applique (con illuminazione verso la superficie di installazione).  
Application: both as ceiling (downlight or uplight mounting) or wall lamp (only wallward light).

example composition code PL UL2160LED AN XX

## PL UL 1 160 h10 cm recessed

## PL UL 2 160 h25 cm recessed

PL UL 1: kg 5 m<sup>3</sup> 0.280

PL UL 2: kg 5.4 m<sup>3</sup> 0.280

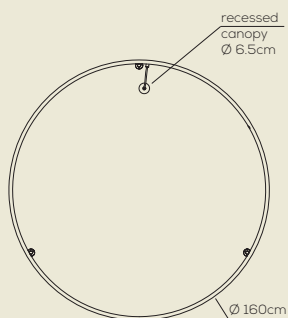

rosone incasso / recessed canopy  
hole Ø 4.5 cm

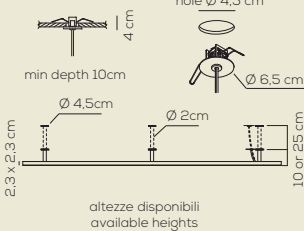

altezze disponibili  
available heights



10 cm  
height

25 cm  
height

U-LIGHT / h10 cm or h25 cm recessed ceiling lamp / DRIVER NOT INCLUDED

Type	Article	Colours	Version	Source
PL	UL 1 160 LED (h10 cm)	AN anthracite grey	IN recessed canopy	LED 102W - diffused beam <b>3000K*, 2700K</b> 24VDC other CCT options available upon request.
	UL 2 160 LED (h25 cm)	RU rust brown		

CE IP20 CRI90 LED ~8575 lm\* 84 lm/W\* 24Vdc

foro - hole Ø 4,5 cm / profondità min - min depth 10 cm

Installazione come plafoniera (downlight o uplight) oppure applique (con illuminazione verso la superficie di installazione).  
Application: both as ceiling (downlight or uplight mounting) or wall lamp (only wallward light).

example composition code PL UL1160LED RU IN

optional for more info see page 309



CEDMWC00202 dimmable 1-10V 24VDC driver max 80W x 2 pcs.

CEDMWC00204 dimmable DALI 24VDC driver max 75W x 2 pcs.

# U-light

Timo Ripatti

Collezione composta da lampade da parete, lampade da soffitto e lampade a sospensione in alluminio. Disponibile in due colori e varie dimensioni. Sorgente luminosa a LED integrato dimmerabile.

Collection consisting of wall lamps, ceiling lamps and suspended lamps in aluminium. Available in two colours and several sizes. Built-in LED dimmable light source.

## PL UL 1 180 h10 cm canopy

## PL UL 2 180 h25 cm canopy

PL UL 1: kg 10,4 m<sup>3</sup> 0,330

PL UL 2: kg 11,0 m<sup>3</sup> 0,330

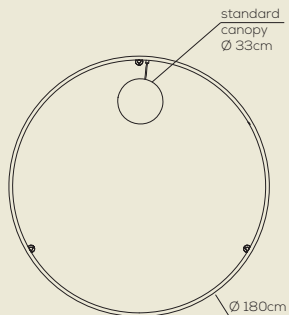

rosone standard / standard canopy

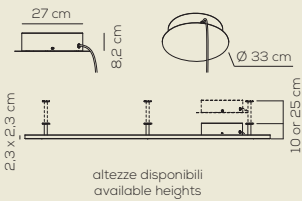

altezze disponibili available heights

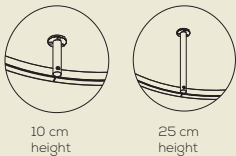

10 cm height

25 cm height

U-LIGHT / h10 cm or h25 cm ceiling lamp with canopy / DRIVER INCLUDED

Type	Article	Colours	Version	Source
PL	UL 1 180 LED (h10 cm)	AN anthracite grey	XX standard canopy	LED 153W - diffused beam <b>3000K*, 2700K</b> other CCT options available upon request.
	UL 2 180 LED (h25 cm)	RU rust brown		

CE IP20 CRI90  **LED** ~9800 lm\* 64 lm/W\* 100-240VAC

Installazione come plafoniera (downlight o uplight) oppure applique (con illuminazione verso la superficie di installazione).  
Application: both as ceiling (downlight or uplight mounting) or wall lamp (only wallward light).

example composition code PL UL2180LED AN XX

## PL UL 1 180 h10 cm recessed

## PL UL 2 180 h25 cm recessed

PL UL 1: kg 5,7 m<sup>3</sup> 0,310

PL UL 2: kg 6,1 m<sup>3</sup> 0,310

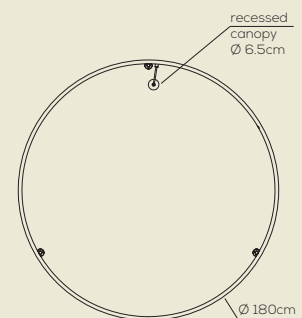

rosone incasso / recessed canopy

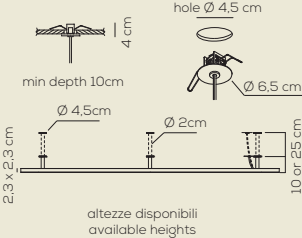

altezze disponibili available heights

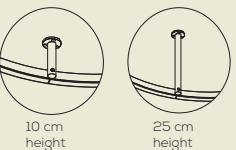

10 cm height

25 cm height

U-LIGHT / h10 cm or h25 cm recessed ceiling lamp / DRIVER NOT INCLUDED

Type	Article	Colours	Version	Source
PL	UL 1 180 LED (h10 cm)	AN anthracite grey	IN recessed canopy	LED 123W - diffused beam <b>3000K*, 2700K</b> 24VDC other CCT options available upon request.
	UL 2 180 LED (h25 cm)	RU rust brown		

CE  IP20 CRI90  **LED** ~9800 lm\* 108 lm/W\* 24Vdc

foro - hole  $\varnothing$  4,5 cm / profondità min - min depth 10 cm

Installazione come plafoniera (downlight o uplight) oppure applique (con illuminazione verso la superficie di installazione).  
Application: both as ceiling (downlight or uplight mounting) or wall lamp (only wallward light).

example composition code PL UL1180LED RU IN

optional for more info see page 309



CEDMWC00203 dimmable 1-10V 24VDC driver max 100W x 2 pcs.

CEDMWC00205 dimmable DALI 24VDC driver max 100W x 2 pcs.

# U-light

Timo Ripatti

Collezione composta da lampade da parete, lampade da soffitto e lampade a sospensione in alluminio. Disponibile in due colori e varie dimensioni. Sorgente luminosa a LED integrato dimmerabile.

Collection consisting of wall lamps, ceiling lamps and suspended lamps in aluminium. Available in two colours and several sizes. Built-in LED dimmable light source.

## SP ULA 090 canopy SP ULA 090 recessed

canopy kg 5.8 m<sup>3</sup> 0.128  
recessed kg 2.5 m<sup>3</sup> 0.126

Installazione downlight o uplight.  
Downlight or uplight mounting.

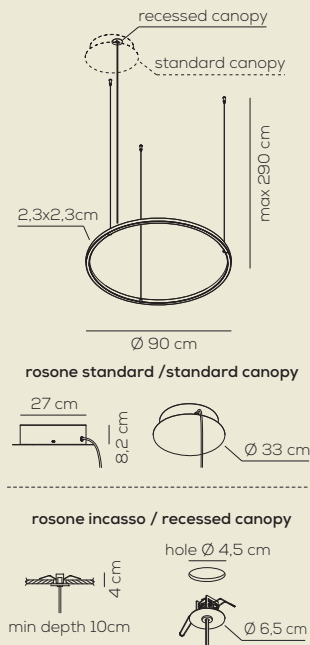

U-LIGHT / suspension with canopy / DRIVER INCLUDED

Type	Article	Colours	Version	Source
SP	ULA 090 LED	AN anthracite grey RU rust brown	XX standard canopy	LED 63W - diffused beam <b>3000K*, 2700K</b> other CCT options available upon request.

CE IP20 CRI90 ~4904 lm\* 78 lm/W\* 100-240VAc

example composition code SP ULA090LED RU XX

U-LIGHT / recessed suspension lamp / DRIVER NOT INCLUDED

Type	Article	Colours	Version	Source
SP	ULA 090 LED	AN anthracite grey RU rust brown	IN recessed canopy	LED 54W - diffused beam <b>3000K*, 2700K</b> 24VDC other CCT options available upon request.

CE IP20 CRI90 ~4904 lm\* 91 lm/W\* 24Vdc

foro - hole Ø 4,5 cm / profondità min - min depth 10 cm

example composition code SP ULA090LED AN IN

optional for more info see page 309

CEDMWC00202 dimmable 1-10V 24VDC driver max 80W  
 CEDMWC00204 dimmable DALI 24VDC driver max 75W

## SP ULA 120 canopy SP ULA 120 recessed

canopy kg 6.5 m<sup>3</sup> 0.180  
recessed kg 3 m<sup>3</sup> 0.150

Installazione downlight o uplight.  
Downlight or uplight mounting.

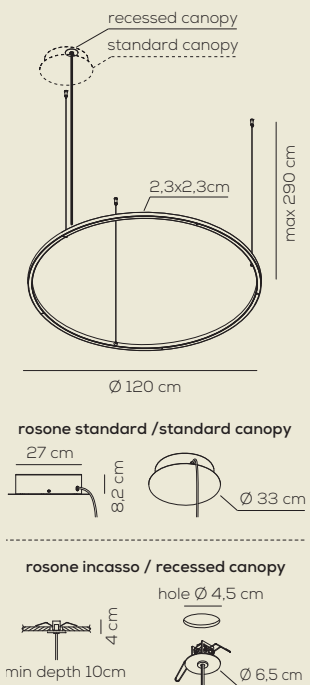

U-LIGHT / suspension with canopy / DRIVER INCLUDED

Type	Article	Colours	Version	Source
SP	ULA 120 LED	AN anthracite grey RU rust brown	XX standard canopy	LED 86W - diffused beam <b>3000K*, 2700K</b> other CCT options available upon request.

CE IP20 CRI90 ~7354 lm\* 86 lm/W\* 100-240VAc

example composition code SP ULA120LED AN XX

U-LIGHT / recessed suspension lamp / DRIVER NOT INCLUDED

Type	Article	Colours	Version	Source
SP	ULA 120 LED	AN anthracite grey RU rust brown	IN recessed canopy	LED 74W - diffused beam <b>3000K*, 2700K</b> 24VDC other CCT options available upon request.

CE IP20 CRI90 ~7354 lm\* 99 lm/W\* 24Vdc

foro - hole Ø 4,5 cm / profondità min - min depth 10 cm

example composition code SP ULA120LED RU IN

optional for more info see page 309

CEDMWC00203 dimmable 1-10V 24VDC driver max 100W  
 CEDMWC00205 dimmable DALI 24VDC driver max 100W



# U-light

Timo Ripatti

Collezione composta da lampade da parete, lampade da soffitto e lampade a sospensione in alluminio. Disponibile in due colori e varie dimensioni. Sorgente luminosa a LED integrato dimmerabile.

Collection consisting of wall lamps, ceiling lamps and suspended lamps in aluminium. Available in two colours and several sizes. Built-in LED dimmable light source.

## SP ULA 160 canopy SP ULA 160 recessed

canopy kg 9.1 m<sup>3</sup> 0.310  
recessed kg 4.8 m<sup>3</sup> 0.280

Installazione downlight o uplight.  
Downlight or uplight mounting.

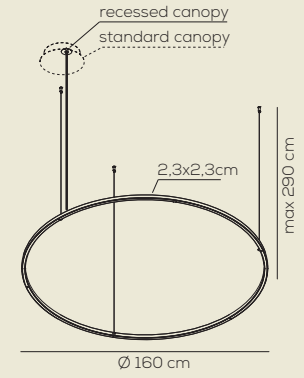

rosone standard / standard canopy



rosone incasso / recessed canopy



min depth 10cm

U-LIGHT / suspension with canopy / DRIVER INCLUDED

Type	Article	Colours	Version	Source
SP	ULA 160 LED	AN anthracite grey RU rust brown	XX standard canopy	LED 125W - diffused beam <b>3000K*, 2700K</b> other CCT options available upon request.

CE IP20 CRI90 LED ~8575 lm\* 69 lm/W\* 100-240VAC

example composition code SP ULA160LED RU XX

U-LIGHT / recessed suspension lamp / DRIVER NOT INCLUDED

Type	Article	Colours	Version	Source
SP	ULA 160 LED	AN anthracite grey RU rust brown	IN recessed canopy	LED 102W - diffused beam <b>3000K*, 2700K</b> 24VDC other CCT options available upon request.

CE IP20 CRI90 LED ~8575 lm\* 84 lm/W\* 24Vdc

foro - hole Ø 4,5 cm / profondità min - min depth 10 cm

example composition code SP ULA160LED AN IN

optional for more info see page 309

	CEDMWC00202	dimmer 1-10V 24VDC driver max 80W X 2 pcs.
	CEDMWC00204	dimmer DALI 24VDC driver max 75W X 2 pcs.

## SP ULA 180 canopy SP ULA 180 recessed

canopy kg 10,5 m<sup>3</sup> 0,330  
recessed kg 5,4 m<sup>3</sup> 0,310

Installazione downlight o uplight.  
Downlight or uplight mounting.

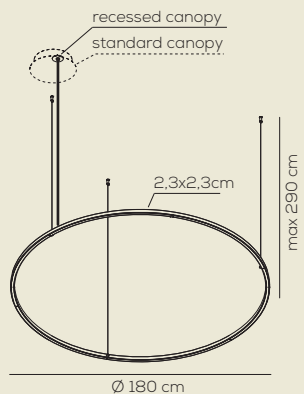

rosone standard / standard canopy



rosone incasso / recessed canopy

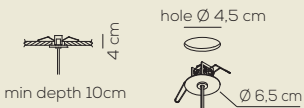

min depth 10cm

U-LIGHT / suspension with canopy / DRIVER INCLUDED

Type	Article	Colours	Version	Source
SP	ULA 180 LED	AN anthracite grey RU rust brown	XX standard canopy	LED 153W - diffused beam <b>3000K*, 2700K</b> other CCT options available upon request.

CE IP20 CRI90 LED ~9800 lm\* 64 lm/W\* 100-240VAC

example composition code SP ULA180LED RU XX

U-LIGHT / recessed suspension lamp / DRIVER NOT INCLUDED

Type	Article	Colours	Version	Source
SP	ULA 180 LED	AN anthracite grey RU rust brown	IN recessed canopy	LED 123W - diffused beam <b>3000K*, 2700K</b> 24VDC other CCT options available upon request.

CE IP20 CRI90 LED ~9800 lm\* 80 lm/W\* 24Vdc

foro - hole Ø 4,5 cm / profondità min - min depth 10 cm

example composition code SP ULA180LED AN IN

optional for more info see page 309

	CEDMWC00203	dimmer 1-10V 24VDC driver max 100W X 2 pcs.
	CEDMWC00205	dimmer DALI 24VDC driver max 100W x 2 pcs.

# U-light

Timo Ripatti

Collezione composta da lampade da parete, lampade da soffitto e lampade a sospensione in alluminio. Disponibile in due colori e varie dimensioni. Sorgente luminosa a LED integrato dimmerabile.

Collection consisting of wall lamps, ceiling lamps and suspended lamps in aluminium. Available in two colours and several sizes. Built-in LED dimmable light source.

## SP ULI 090

kg 7.2 m<sup>3</sup> 0.19

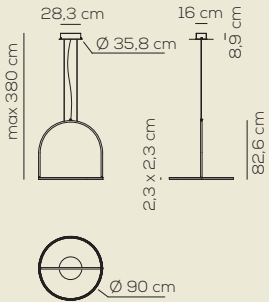

U-LIGHT / downward lighting only / DRIVER INCLUDED

Type	Article	Colours	Code End	Source
SP	ULI 090 LED	AN anthracite grey RU rust brown	XX	LED 63W - diffused beam <b>3000K*, 2700K</b> other CCT options available upon request.

~4904 lm\* 78 lm/W\* 100-240VAc  
 example composition code SP ULI090LED RU XX

## SP ULI 120

kg 8.2 m<sup>3</sup> 0.33

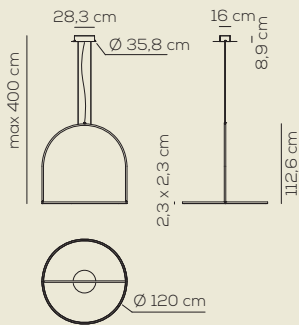

U-LIGHT / downward lighting only / DRIVER INCLUDED

Type	Article	Colours	Code End	Source
SP	ULI 120 LED	AN anthracite grey RU rust brown	XX	LED 86W - diffused beam <b>3000K*, 2700K</b> other CCT options available upon request.

~7354 lm\* 86 lm/W\* 100-240VAc  
 example composition code SP ULI120LED RU XX

## SP ULI 160

kg 18.8 m<sup>3</sup> 0.6

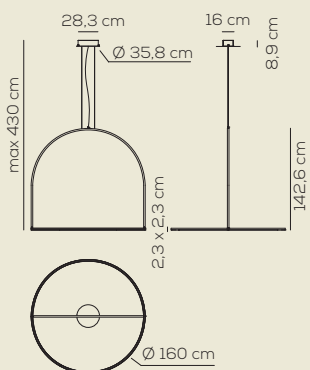

U-LIGHT / downward lighting only / DRIVER INCLUDED

Type	Article	Colours	Code End	Source
SP	ULI 160 LED	AN anthracite grey RU rust brown	XX	LED 125W - diffused beam <b>3000K*, 2700K</b> other CCT options available upon request.

~9900 lm\* 88 lm/W\* 100-240VAc  
 example composition code SP ULI160LED RU XX

# Ukiyo

Manuel Vivian

Collezione composta da lampade da parete o da soffitto con struttura metallica e rivestimento in tessuto bianco retato elasticizzato, sfoderabile e lavabile. Disponibile in tre dimensioni. Sorgente luminosa con attacco a vite.

Collection consisting of ceiling or wall lamps with metal frame and white removable, washable elastic mesh fabric covering. Available in three sizes. Screw fitting light source.

## COLOURS



white

## PL UKIYO P

kg 1.7 m<sup>3</sup> 0.06

UKIYO / tessuto INCLUSO - applicazione a soffitto o a parete / fabric INCLUDED - application: both as ceiling or wall lamp

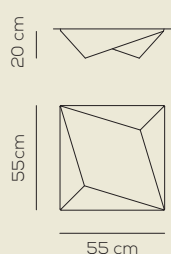

Type	Article	Colours	Finish	Source
PL	UKIYO P	BC white	XX white metal	E27 3 x Max 6,5W LED or 3 x Max 42W halo

CE IP20 +LED 220-240V<sub>ac</sub>

example composition code PL UKIYOP BC XX E27

TESSUTO SUPPLEMENTARE SU RICHIESTA / ADDITIONAL FABRIC UPON REQUEST:

TSPLUKIYO60X60BC white

## PL UKI 110

kg 3 m<sup>3</sup> 0.12

UKIYO / tessuto INCLUSO - applicazione a soffitto o a parete / fabric INCLUDED - application: both as ceiling or wall lamp

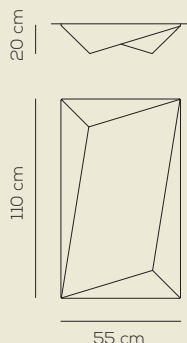

Type	Article	Colours	Finish	Source
PL	UKI 110	BC white	XX white metal	E27 3 x Max 16W LED or 3 x Max 70W halo

CE IP20 +LED 220-240V<sub>ac</sub>

example composition code PL UKI110 BC XX E27

TESSUTO SUPPLEMENTARE SU RICHIESTA / ADDITIONAL FABRIC UPON REQUEST:

TSPLUKIYO100X55BC white

## PL UKIYO G

kg 3.6 m<sup>3</sup> 0.24

UKIYO / tessuto INCLUSO - applicazione a soffitto o a parete / fabric INCLUDED - application: both as ceiling or wall lamp

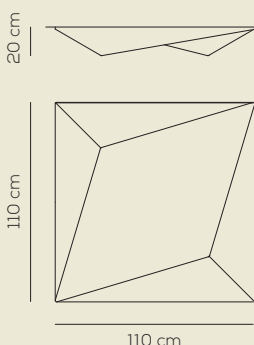

Type	Article	Colours	Finish	Source
PL	UKIYO G	BC white	XX white metal	E27 3 x Max 16W LED or 3 x Max 70W halo

CE IP20 +LED 220-240V<sub>ac</sub>

example composition code PL UKIYOG BC XX E27

TESSUTO SUPPLEMENTARE SU RICHIESTA / ADDITIONAL FABRIC UPON REQUEST:

TSPLUKIYO100X100BC white

# Urban

Dima Loginoff

Collezione composta da lampade da soffitto e lampade a sospensione in alluminio. Disponibile in tre colori e dimensioni. Le sospensioni sono disponibili anche nella versione ad incasso. Sorgente luminosa a LED integrato dimmerabile.

Collection consisting of aluminium ceiling lamps and suspended lamps, also in a recessed version. Available in three colours and sizes. Built-in dimmable LED light source.

## COLOURS



wrinkled white



matt bronze



matt nickel



standard canopy



recessed canopy

## PL URBAN P

kg 1,6 m<sup>3</sup> 0,02



8,3 cm

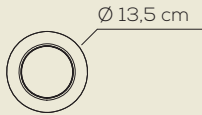

Ø 13,5 cm

### URBAN

Type	Article	Colours	Finishing	Source
PL	URBAN P	BC wrinkled white	XX	LED 15W - diffused beam 3000K*, 2700K, 4000K
		BR matt bronze		
		NI matt nickel		

IP20 CRI90 220-240V<sub>AC</sub> **LED** ~1350 lm\* 90 lm/W\*

example composition code PL URBANP NI XX LED

## PL URBAN M

kg 1,3 m<sup>3</sup> 0,02



13,8 cm

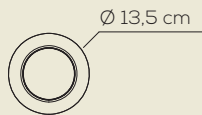

Ø 13,5 cm

### URBAN

Type	Article	Colours	Finishing	Source
PL	URBAN M	BC wrinkled white	XX	LED 15W - diffused beam 3000K*, 2700K, 4000K
		BR matt bronze		
		NI matt nickel		

IP20 CRI90 220-240V<sub>AC</sub> **LED** ~1350 lm\* 90 lm/W\*

example composition code PL URBANM NI XX LED

# Urban

Dima Loginoff

Collezione composta da lampade da soffitto e lampade a sospensione in alluminio. Disponibile in tre colori e dimensioni. Le sospensioni sono disponibili anche nella versione ad incasso. Sorgente luminosa a LED integrato dimmerabile.

Collection consisting of aluminium ceiling lamps and suspended lamps, also in a recessed version. Available in three colours and sizes. Built-in dimmable LED light source.

## PL URBAN G

kg 1,7 m<sup>3</sup> 0,025



### URBAN

Type	Article	Colours	Finishing	Source
PL	URBAN P	BC wrinkled white BR matt bronze NI matt nickel	XX	LED 15W - diffused beam 3000K*, 2700K, 4000K

IP20 CRI90 220-240VAC **LED** ~1350 lm\* 90 lm/W\*  
 example composition code PL URBANP NI XX LED

## SP URBAN P

kg 1,9 m<sup>3</sup> 0,02

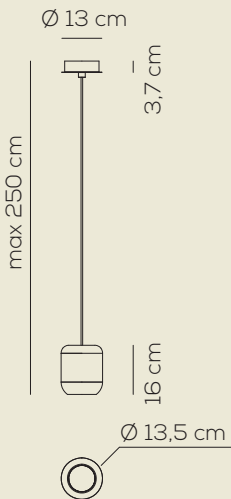

URBAN / solo con illuminazione verso il basso / downward lighting only

Type	Article	Colours	Finishing	Source
SP	URBAN P	BC wrinkled white BR matt bronze NI matt nickel	XX	LED 15W - diffused beam 3000K*, 2700K, 4000K

IP20 CRI90 220-240VAC **LED** ~1350 lm\* 90 lm/W\*  
 example composition code SP URBANP BR XX LED

## SP URBAN M

kg 2,3 m<sup>3</sup> 0,025

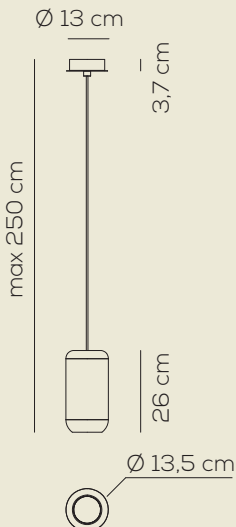

URBAN / solo con illuminazione verso il basso / downward lighting only

Type	Article	Colours	Finishing	Source
SP	URBAN M	BC wrinkled white BR matt bronze NI matt nickel	XX	LED 15W - diffused beam 3000K*, 2700K, 4000K

IP20 CRI90 220-240VAC **LED** ~1350 lm\* 90 lm/W\*  
 example composition code SP URBANM BR XX LED

# Urban

Dima Loginoff

Collezione composta da lampade da soffitto e lampade a sospensione in alluminio. Disponibile in tre colori e dimensioni. Le sospensioni sono disponibili anche nella versione ad incasso. Sorgente luminosa a LED integrato dimmerabile.

Collection consisting of aluminium ceiling lamps and suspended lamps, also in a recessed version. Available in three colours and sizes. Built-in dimmable LED light source.

## SP URBA P I (RECESSED)

kg 1,7 m³ 0,02

URBAN / solo con illuminazione verso il basso / downward lighting only

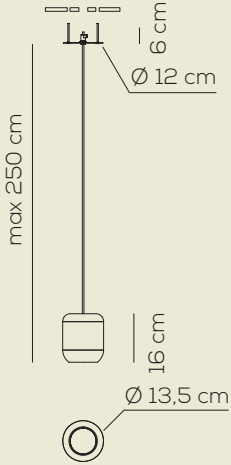

Type	Article	Colours	Finishing	Source
SP	URBA P I	<b>BC</b> wrinkled white  <b>BR</b> matt bronze  <b>NI</b> matt nickel	XX	<b>LED</b> 15W - diffused beam <b>3000K*, 2700K, 4000K</b>

220-240V<sub>AC</sub> **LED** ~1350 lm\* 90 lm/W\*

foro - hole Ø 4,5 cm / profondità min - min depth 10 cm

example composition code **SP URBAPI BR XX LED**

## SP URBA M I (RECESSED)

kg 2,1 m³ 0,025

URBAN / solo con illuminazione verso il basso / downward lighting only

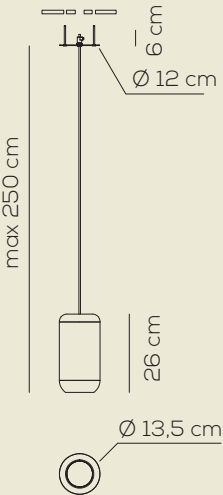

Type	Article	Colours	Finishing	Source
SP	URBA M I	<b>BC</b> wrinkled white  <b>BR</b> matt bronze  <b>NI</b> matt nickel	XX	<b>LED</b> 15W - diffused beam <b>3000K*, 2700K, 4000K</b>

220-240V<sub>AC</sub> **LED** ~1350 lm\* 90 lm/W\*

foro - hole Ø 4,5 cm / profondità min - min depth 10 cm

example composition code **SP URBAMI BR XX LED**

# Urban mini

Dima Loginoff

Collezione composta da lampade da soffitto e lampade a sospensione in alluminio. Disponibile in tre colori e dimensioni. Le sospensioni sono disponibili anche nella versione ad incasso. Sorgente luminosa a LED integrato dimmerabile.

Collection consisting of aluminium ceiling lamps and suspended lamps, also in a recessed version. Available in three colours and sizes. Built-in dimmable LED light source.

## COLOURS



wrinkled white



matt bronze



matt nickel



standard canopy



recessed canopy

## PL URBMI P

kg 0,4 m<sup>3</sup> 0,004

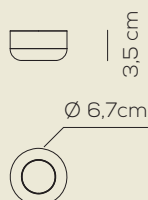

### URBAN MINI

Type	Article	Colours	Finishing	Source
PL	URB MI P	BC wrinkled white	XX	LED 8W - diffused beam 3000K*, 2700K, 4000K
		BR matt bronze		
		NI matt nickel		

IP20 CRI90
 220-240V<sub>AC</sub>
 ~560 lm\* 70 lm/W\*

example composition code PL URBMIP BR XX LED

## PL URBMI M

kg 0,5 m<sup>3</sup> 0,02

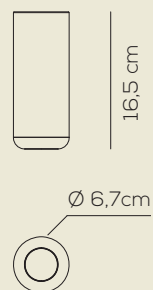

### URBAN MINI

Type	Article	Colours	Finishing	Source
PL	URB MI M	BC wrinkled white	XX	LED 8W - diffused beam 3000K*, 2700K, 4000K
		BR matt bronze		
		NI matt nickel		

IP20 CRI90
 220-240V<sub>AC</sub>
 ~560 lm\* 70 lm/W\*

example composition code PL URBMIM BR XX LED

# Urban mini

Dima Loginoff

Collezione composta da lampade da soffitto e lampade a sospensione in alluminio. Disponibile in tre colori e dimensioni. Le sospensioni sono disponibili anche nella versione ad incasso. Sorgente luminosa a LED integrato dimmerabile.

Collection consisting of aluminium ceiling lamps and suspended lamps, also in a recessed version. Available in three colours and sizes. Built-in dimmable LED light source.

## PL URBMI G

kg 0,8 m<sup>3</sup> 0,025

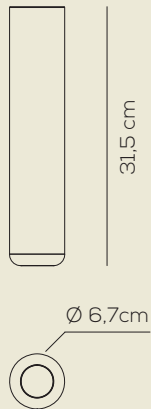

### URBAN MINI

Type	Article	Colours	Finishing	Source
PL	URB MI G	BC wrinkled white	XX	LED 8W - diffused beam 3000K*, 2700K, 4000K
		BR matt bronze		
		NI matt nickel		

IP20 CRI90 220-240VAC **LED** ~560 lm\* 70 lm/W\*  
 example composition code PL URBMI G BR XX LED

## SP URMI PI (RECESSED)

kg 0,5 m<sup>3</sup> 0,004

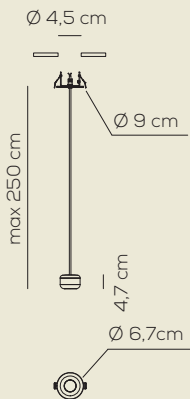

### URBAN MINI / solo con illuminazione verso il basso / downward lighting only

Type	Article	Colours	Finishing	Source
SP	URMI PI	BC wrinkled white	XX	LED 8W - diffused beam 3000K*, 2700K, 4000K
		BR matt bronze		
		NI matt nickel		

IP20 CRI90 220-240VAC **LED** ~560 lm\* 70 lm/W\*  
 foro - hole Ø 4,5 cm / profondità min - min depth 10 cm  
 example composition code SP URMI PI NI XX LED

## SP URMI MI (RECESSED)

kg 0,7 m<sup>3</sup> 0,02

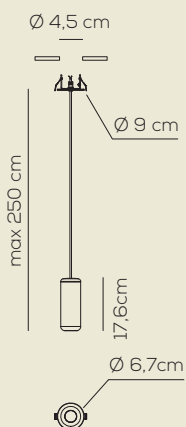

### URBAN MINI / solo con illuminazione verso il basso / downward lighting only

Type	Article	Colours	Finishing	Source
SP	URMI MI	BC wrinkled white	XX	LED 8W - diffused beam 3000K*, 2700K, 4000K
		BR matt bronze		
		NI matt nickel		

IP20 CRI90 220-240VAC **LED** ~560 lm\* 70 lm/W\*  
 foro - hole Ø 4,5 cm / profondità min - min depth 10 cm  
 example composition code SP URMI MI NI XX LED



# Urban mini

Dima Loginoff

Collezione composta da lampade da soffitto e lampade a sospensione in alluminio. Disponibile in tre colori e dimensioni. Le sospensioni sono disponibili anche nella versione ad incasso. Sorgente luminosa a LED integrato dimmerabile.

Collection consisting of aluminium ceiling lamps and suspended lamps, also in a recessed version. Available in three colours and sizes. Built-in dimmable LED light source.

## SP URMIGI (RECESSED)

kg 1 m<sup>3</sup> 0,025

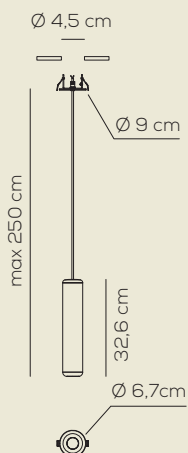

URBAN MINI / solo con illuminazione verso il basso / downward lighting only

Type	Article	Colours	Finishing	Source
SP	URMIGI	BC wrinkled white BR matt bronze NI matt nickel	XX	LED 8W - diffused beam 3000K*, 2700K, 4000K

CE IP20 CRI90  220-240VAC **LED** ~560 lm\* 70 lm/W\*

foro - hole Ø 4,5 cm / profondità min - min depth 10 cm

example composition code SP URMIGI NI XX LED

## SP URBMI P

kg 0,5 m<sup>3</sup> 0,004

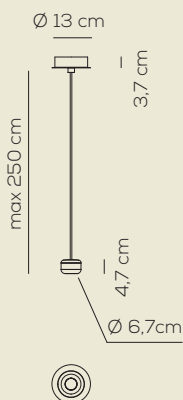

URBAN MINI / solo con illuminazione verso il basso / downward lighting only

Type	Article	Colours	Finishing	Source
SP	URBMI P	BC wrinkled white BR matt bronze NI matt nickel	XX	LED 8W - diffused beam 3000K*, 2700K, 4000K

CE IP20 CRI90  220-240VAC **LED** ~560 lm\* 70 lm/W\*

example composition code SP URBMI P BR XX LED

## SP URBMI M

kg 0,5 m<sup>3</sup> 0,04

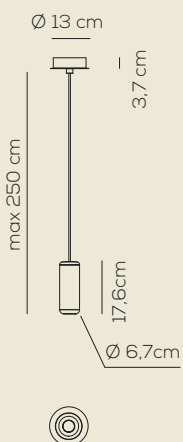

URBAN MINI / solo con illuminazione verso il basso / downward lighting only

Type	Article	Colours	Finishing	Source
SP	URBMI M	BC wrinkled white BR matt bronze NI matt nickel	XX	LED 8W - diffused beam 3000K*, 2700K, 4000K

CE IP20 CRI90  220-240VAC **LED** ~560 lm\* 70 lm/W\*

example composition code SP URBMI M BC XX LED

# Urban mini

Dima Loginoff

Collezione composta da lampade da soffitto e lampade a sospensione in alluminio. Disponibile in tre colori e dimensioni. Le sospensioni sono disponibili anche nella versione ad incasso. Sorgente luminosa a LED integrato dimmerabile.

Collection consisting of aluminium ceiling lamps and suspended lamps, also in a recessed version. Available in three colours and sizes. Built-in dimmable LED light source.

## SP URBMI G

kg 0,5 m<sup>3</sup> 0,04

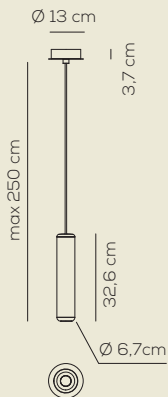

URBAN MINI / solo con illuminazione verso il basso / downward lighting only

Type	Article	Colours	Finishing	Source
SP	URBMI G	<b>BC</b> wrinkled white  <b>BR</b> matt bronze  <b>NI</b> matt nickel	XX	<b>LED</b> 8W - diffused beam 3000K*, 2700K, 4000K

IP20 CRI90 220-240VAC **LED** ~560 lm\* 70 lm/W\*

example composition code SP URBMI G NI XX LED

# Uriel

Manuel Vivian

Collezione composta da lampade da parete in metallo, disponibile in vari colori e dimensioni. Sorgente luminosa con attacco R7S.

Collection consisting of metal wall lamps. Available in several colours and sizes. Light source with R7s fitting.

## COLOURS



pearl white



matt bronze



matt nickel

## AP URIEL P

kg 1 m<sup>3</sup> 0.02

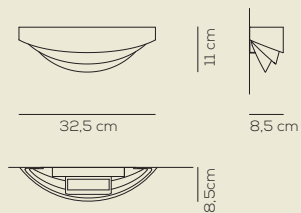

### URIEL

Type	Article	Colours	Code End	Source
AP	URIEL P	BC pearl white	XX	R7S 1 x Max 120W (78)
		BR bronze		
		CR chrome		

Gli articoli in rosso sono disponibili solo fino ad esaurimento scorte. Articles in red are available until sold out.



IP20



220-240V<sub>AC</sub>

example composition code AP URIELP BR XX R7S

## AP URIEL G

kg 2 m<sup>3</sup> 0.08

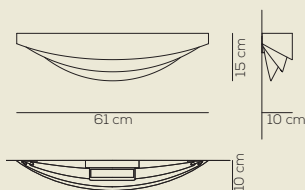

### URIEL

Type	Article	Colours	Code End	Source
AP	URIEL G	BC pearl white	XX	R7S 1 x Max 160W (118)
		BR bronze		
		CR chrome		

Gli articoli in rosso sono disponibili solo fino ad esaurimento scorte. Articles in red are available until sold out.



IP20



220-240V<sub>AC</sub>

example composition code AP URIELG CR XX R7S

COLOURS



textured white



polished steel

**AP VASILY**

kg 1 m<sup>3</sup> 0.02

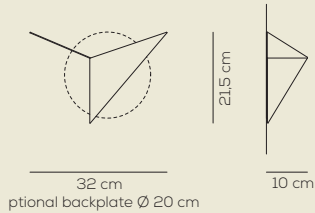

optional backplate Ø 20 cm



VASILY

Type	Article	Colours	Finish	Source
AP	VASILY	BC textured white	XX	G9X G9 1 x Max 60W halo
		CR polished steel		

Gli articoli in rosso sono disponibili solo fino ad esaurimento scorte. Articles in red are available until sold out.

CE IP20 ADA 220-240V<sub>AC</sub>

example composition code AP VASILY CR XX G9X

optional:

PLACCAVASILYBC placca bianco texturizzato / textured white backplate

PLACCAVASILYCR placca acciaio lucido / polished steel backplate

# Velvet

Manuel Vivian

Collezione di lampade a sospensione e da soffitto con paralume troncoconico in tessuto ignifugato. Disponibile in vari colori e dimensioni.

Collection of ceiling and suspended lamps. The cone-shaped lampshade is covered with a flame-retardant. Available in several colours and sizes.

## COLOURS



ice white



orange

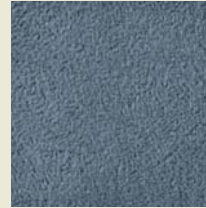

light blue



ivory white



blue



brown



black



burgundy

## RADIAL DIFFUSER COLOURS

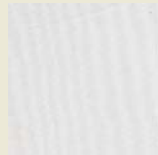

white



electric blue



warm white

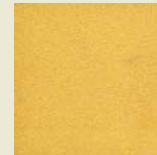

gold yellow



brown



brick red



black

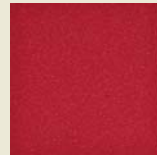

burgundy



red



green

## PL VEL 070

kg 7 m<sup>3</sup> 0.28

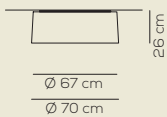

VELVET / diffusore INCLUSO / diffuser INCLUDED

Type	Article	Colours (lampshade)	Colour (Radial diffuser)	Source
PL	VEL 070 E27	BC ice white	BC white	E27 2 x Max 16W LED or 2 x Max 20W fluo
		AR orange	BL electric blue	
		AZ light blue	BW warm white	
		BA ivory white	GI gold yellow	
		BL blue	MA brown	
		MA brown	MT brick red	
		NE black	NE black	
		RB burgundy	RB burgundy	
			RS red	
			VE green	



IP20 +LED

220-240V<sub>AC</sub>

example composition code PL VEL070E27 BL RS

# Velvet

Manuel Vivian

Collezione di lampade a sospensione e da soffitto con paralume troncoconico in tessuto ignifugato. Disponibile in vari colori e dimensioni.

Collection of ceiling and suspended lamps. The cone-shaped lampshade is covered with a flame-retardant. Available in several colours and sizes.

## PL VEL 100

kg 9 m<sup>3</sup> 0.98



VELVET / diffusore INCLUSO / diffuser INCLUDED

Type	Article	Colours (lampshade)	Colour (Radial diffuser)	Source
PL	VEL 100 E27	BC ice white	BC white	E27 3 x Max 16W LED or 3 x Max 57W halo
		AR orange	BL electric blue	
		AZ light blue	BW warm white	
		BA ivory white	GI gold yellow	
		BL blue	MA brown	
		MA brown	MT brick red	
		NE black	NE black	
		RB burgundy	RB burgundy	
			RS red	
			VE green	



IP20 +LED

220-240V<sub>ac</sub>

example composition code PL VEL100E27 NE GI

## PL VEL 160

kg 32 m<sup>3</sup> 2.22

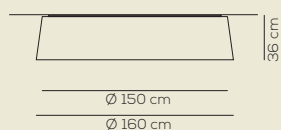

VELVET / diffusore INCLUSO / diffuser INCLUDED

Type	Article	Colours (lampshade)	Colour (Radial diffuser)	Source
PL	VEL 160 E27	BC ice white	BC white	E27 5 x Max 16W LED or 5 x Max 46W halo
		AR orange	BL electric blue	
		AZ light blue	BW warm white	
		BA ivory white	GI gold yellow	
		BL blue	MA brown	
		MA brown	MT brick red	
		NE black	NE black	
		RB burgundy	RB burgundy	
			RS red	
			VE green	



IP20 +LED

220-240V<sub>ac</sub>

example composition code PL VEL160E27 BL BC

# Velvet

Manuel Vivian

Collezione di lampade a sospensione e da soffitto con paralume troncoconico in tessuto ignifugato. Disponibile in vari colori e dimensioni.

Collection of ceiling and suspended lamps. The cone-shaped lampshade is covered with a flame-retardant. Available in several colours and sizes.

## SP VEL 050

kg 5 m<sup>3</sup> 0.25

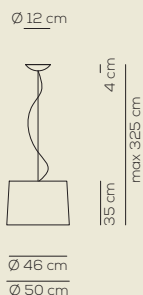

VELVET / diffusore INCLUSO / diffuser INCLUDED

Type	Article	Colours (lampshade)	Colour (Radial diffuser)	Source
SP	VEL 050 E27	BC ice white	BC white	E27 1 x Max 16W LED or 1 x Max 23W halo
		AR orange	BL electric blue	
		AZ light blue	BW warm white	
		BA ivory white	GI gold yellow	
		BL blue	MA brown	
		MA brown	MT brick red	
		NE black	NE black	
		RB burgundy	RB burgundy	
			RS red	
			VE green	



IP20 +LED

220-240V<sub>AC</sub>

example composition code SP VEL050E27 BC BC

## SP VEL 070

kg 6.5 m<sup>3</sup> 0.48

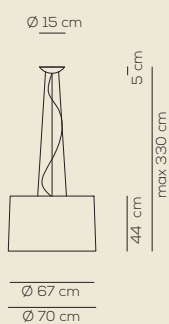

VELVET / diffusore INCLUSO / diffuser INCLUDED

Type	Article	Colours (lampshade)	Colour (Radial diffuser)	Source
SP	VEL 100 E27	BC ice white	BC white	E27 1 x Max 20W LED or 1 x Max 70W halo
		AR orange	BL electric blue	
		AZ light blue	BW warm white	
		BA ivory white	GI gold yellow	
		BL blue	MA brown	
		MA brown	MT brick red	
		NE black	NE black	
		RB burgundy	RB burgundy	
			RS red	
			VE green	



IP20 +LED

220-240V<sub>AC</sub>

example composition code SP VEL070E27 NE GI

# Velvet

Manuel Vivian

Collezione di lampade a sospensione e da soffitto con paralume troncoconico in tessuto ignifugato. Disponibile in vari colori e dimensioni.

Collection of ceiling and suspended lamps. The cone-shaped lampshade is covered with a flame-retardant. Available in several colours and sizes.

## SP VEL 100

kg 17.5 m<sup>3</sup> 1.16

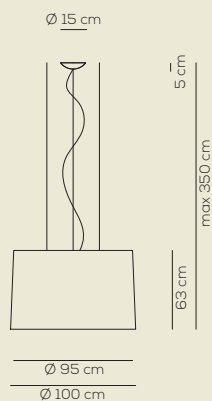

VELVET / diffusore INCLUSO, con illuminazione verso alto e basso / diffuser INCLUDED, with upward and downward lighting

Type	Article	Colours (lampshade)	Colour (Radial diffuser)	Source
SP	VEL 100 E27	BC ice white	BC white	E27 4 x Max 20W LED or 4 x Max 57W halo
		AR orange	BL electric blue	
		AZ light blue	BW warm white	
		BA ivory white	GI gold yellow	
		BL blue	MA brown	
		MA brown	MT brick red	
		NE black	NE black	
		RB burgundy	RB burgundy	
			RS red	
			VE green	



IP20 +LED

220-240V<sub>AC</sub>

example composition code SP VEL100E27 MA BC

## SP VEL 100 LED

VELVET / diffuser INCLUDED, with upward and downward lighting / DRIVER INCLUDED

Type	Article	Colours (lampshade)	Colour (Radial diffuser)	Source
PL	VEL 100 LED	BC ice white	BC white	LED 98W - diffused beam 3000K*, 4000K
		AR orange	BL electric blue	
		AZ light blue	BW warm white	
		BA ivory white	GI gold yellow	
		BL blue	MA brown	
		MA brown	MT brick red	
		NE black	NE black	
		RB burgundy	RB burgundy	
			RS red	
			VE green	



IP20 CRI90



LED

~10719 lm\* 109 lm/W\*

110-240V<sub>AC</sub>

example composition code PL VEL100E27 NE GI



# Velvet

Manuel Vivian

Collezione di lampade a sospensione e da soffitto con paralume troncoconico in tessuto ignifugato. Disponibile in vari colori e dimensioni.

Collection of ceiling and suspended lamps. The cone-shaped lampshade is covered with a flame-retardant. Available in several colours and sizes.

## SP VEL 160

kg 25 m<sup>3</sup> 4.32

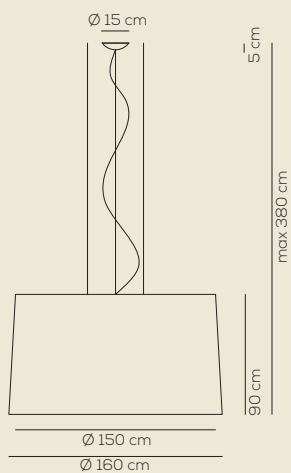

VELVET / diffusore INCLUSO, con illuminazione verso alto e basso / diffuser INCLUDED, with upward and downward lighting

Type	Article	Colours (lampshade)	Colour (Radial diffuser)	Source
SP	VEL 160 E27	BC ice white	BC white	E27 4 x Max 16W + 1 x Max 9,5W LED
		AR orange	BL electric blue	or 4 x Max 57 W + 1xMax 46W halo
		AZ light blue	BW warm white	
		BA ivory white	GI gold yellow	
		BL blue	MA brown	
		MA brown	MT brick red	
		NE black	NE black	
		RB burgundy	RB burgundy	
			RS red	
			VE green	



IP20 +LED

220-240V<sub>AC</sub>

example composition code SP VEL160E27 AR BC

## SP VEL 160 LED

VELVET / diffuser INCLUDED, with upward and downward lighting / DRIVER INCLUDED

Type	Article	Colours (lampshade)	Colour (Radial diffuser)	Source
SP	VEL 160 LED	BC ice white	BC white	LED 98W - diffused beam 3000K, 4000K
		AR orange	BL electric blue	
		AZ light blue	BW warm white	
		BA ivory white	GI gold yellow	
		BL blue	MA brown	
		MA brown	MT brick red	
		NE black	NE black	
		RB burgundy	RB burgundy	
			RS red	
			VE green	



IP20 CRI90



LED ~10719 lm\* 109 lm/W\*

110-240V<sub>AC</sub>

example composition code SP VEL160LED MA BC

# Virtus

Manuel Vivian

Collezione composta da lampade a sospensione in alluminio in vari colori.  
Disponibile anche nella versione ad incasso. Sorgente luminosa a LED integrato dimmerabile.

Collection consisting of suspended lamps in aluminium, also in a recessed version.  
Available in several colours. Built-in dimmable LED light source.

## COLOURS



matt white RAL 9016 wrinkled



anthracite grey wrinkled / final black polished nickel

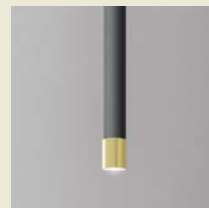

anthracite grey wrinkled / final polished gold



rust brown wrinkled / final black polished nickel

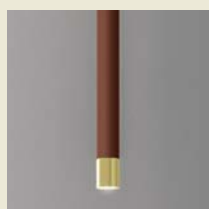

rust brown wrinkled / final polished gold

## CANOPIES DETAILS



white for white version



anthracite grey for anthracite version



rust brown for rust brown version

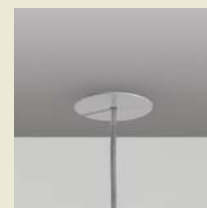

white for recessed versions

## VIRTUS SUSPENSION

kg 0.89 m<sup>3</sup> 0.015

VIRTUS / LED 4W / DRIVER INCLUDED

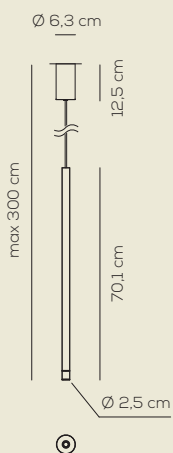

Zone	Type	Article	System compatibility	Finish	LED colour temperature	Beam options
E	2	101	1  monopoint canopy version	07 matt white RAL 9016 wrinkled	1  3000 K	2  medium beam not adjustable
				10 anthracite grey wrinkled / final black polished nickel	3  4000 K	
				11 anthracite grey wrinkled / final polished gold		
				12 rust brown wrinkled / final black polished nickel		
				13 rust brown wrinkled / final polished gold		



IP20

CRI90



~295 lm\* 74 lm/W\*

220-240Vac

example composition code E 2 101 1 11 1 2

optional accessories

E000700900 Kit decentramento bianco Ø 2,2 x 2 cm / White decentralization kit Ø 2,2 x 2 cm.

# Virtus

Manuel Vivian

Collezione composta da lampade a sospensione in alluminio in vari colori.  
Disponibile anche nella versione ad incasso. Sorgente luminosa a LED integrato dimmerabile.



Collection consisting of suspended lamps in aluminium, also in a recessed version.  
Available in several colours. Built-in dimmable LED light source.

## VIRTUS SUSPENSION

kg 0.89 m<sup>3</sup> 0.0015

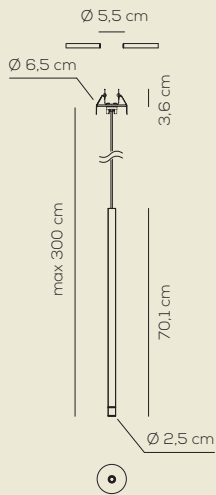
VIRTUS RECESSED / LED 3W / 350mA / DRIVER NOT INCLUDED



Zone	Type	Article	System compatibility	Finish	LED colour temperature	Beam options
E	2	101	4  recessed	07 matt white RAL 9016 wrinkled 10 anthracite grey wrinkled / final black polished nickel 11 anthracite grey wrinkled / final polished gold 12 rust brown wrinkled / final black polished nickel 13 rust brown wrinkled / final polished gold	1 3000 K 3 4000 K	2  medium beam not adjustable

CE  IP20 CRI90  **LED** ~295 lm\* 98 lm/W\*

example composition code E 2 101 4 11 1 2

foro - hole Ø 5,5 cm / profondità min - min depth 10 cm - Collegare in serie. / Wire in series.

optional driver for more info see page 308

E000700900 Kit decentramento bianco Ø 2,2 x 2 cm / White decentralization kit Ø 2,2 x 2 cm.

CEDLTC00100 standard 350mA driver - Max 8W

CEDLTC00101 standard 350mA driver - Max 12W

CEDLTC00102 dimmable 1-10V & PUSH 350mA driver - Max 6W

CEDLTC00103 dimmable 1-10V 350mA driver - Max 25W



CEDLTC00104 dimmable DALI 350mA driver - Max 25W

CEDLLG00302 standard 350mA driver - Max 6W

CEDLLG00303 standard 350mA driver - Max 12W

# Accessori / Accessories - Lampadine / Bulbs

## LAMP BULBS

	Code	Description
	<b>LAMPG92,5WL2701</b>	<b>G9 LED BULB</b> (for Aibu) 2,5W, 200lm, 2700K, beam 330°, Ra>80, A+ class, not dimmable - 220-240VAc
	<b>LAMPGU105,5W040</b>	<b>GU10 LED BULB</b> (for Fedora - Nafir) 5,5W, 350lm, 3000K, beam 40°, A class, not dimmable - 220-240VAc
	<b>LAMPG41,5WL3001</b>	<b>G4 LED BULB</b> (for Spillray G4L) 1,5W, 200lm, 3000K, COB leds, Ra>80, A+ class, not dimmable - 12V AC/DC
	<b>LAMPADINABISP.10W</b>	<b>G4 12V HALOGEN BULB</b> (for Spillray 12V) 10W, 130 lm, 3000K, Ra 100, C class, dimmable - 12VAc
	<b>LAMPADINABISP.20W</b>	<b>G4 12V HALOGEN BULB</b> (for Spillray 12V) 20W, 320 lm, 3000K, Ra 100, C class, dimmable - 12VAc

Gli articoli in rosso sono disponibili solo fino ad esaurimento scorte. *Articles in red are available until sold out.*

# Driver for Ego - 250mA

## STANDARD

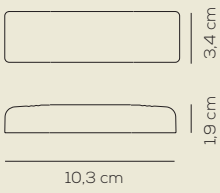

### DRIVER 250mA STANDARD

Code	Product	W Max	Input	Output	Weight
CEDLTC00123	Standard not dimmable	10	100-240Vac 50-60 Hz	250mA constant 44V	net kg 0.06

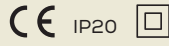

## DIMMABLE PHASE CUT

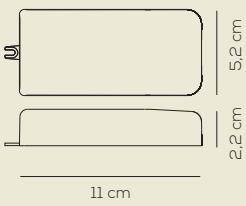

### DRIVER 250mA DIMMABLE PHASE CUT

Code	Product	W Max	Input	Output	Weight
CEDLTC00124	Dimmable phase cut	12	220-240Vac 50-60 Hz	250mA constant 55V	net kg 0.108



## DIMMABLE DALI - 0/1-10V - PUSH

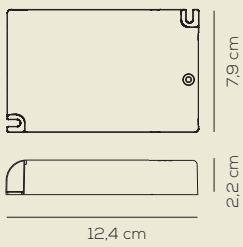

### DRIVER 250mA DIMMABLE DALI 0/1-10V & PUSH

Code	Product	W Max	Input	Output	Weight
CEDLTC00125	Dimmable 0/1-10V - Push	28	110-240Vac 50-60 Hz	250mA constant 119V	net kg 0.215



## DIMMABLE DALI

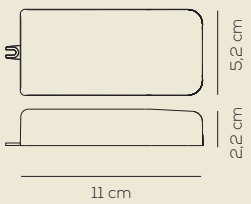

### DRIVER 250mA DIMMABLE DALI

Code	Product	W Max	Input	Output	Weight
CEDLTC00126	Dimmable DALI	12	110-240Vac 50-60 Hz	250mA constant 59V	net kg 0.106



# Driver 350mA

## STANDARD

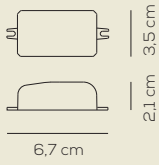

### DRIVER 350mA STANDARD

Code	Product	W Max	Input	Output	Weight
CEDLTC00100	Standard not dimmable	8	220-240V 50-60 Hz	350mA constant 24V	net kg 0.04

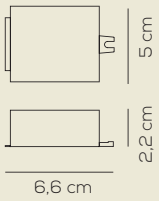
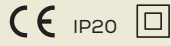

### DRIVER 350mA STANDARD

Code	Product	W Max	Input	Output	Weight
CEDLTC00101	Standard not dimmable	12	100-240V 50-60 Hz	350mA constant 36V	net kg 0.045



## DIMMABLE 1-10V

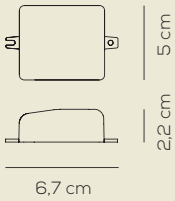

### DRIVER 350mA DIMMABLE 1-10V & PUSH

Code	Product	W Max	Input	Output	Weight
CEDLTC00102	Dimmable 1-10V	6	220-240V 50-60 Hz	350mA constant 24V	net kg 0.06

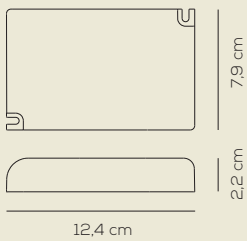

### DRIVER 350mA DIMMABLE 1-10V

Code	Product	W Max	Input	Output	Weight
CEDLTC00103	Dimmable 1-10V	25	110-240V 50-60 Hz	350mA constant 74V Max	net kg 0.15



## DIMMABLE DALI

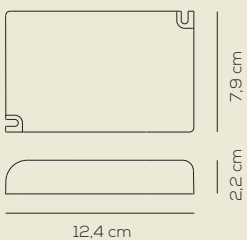

### DRIVER 350mA DIMMABLE DALI

Code	Product	W Max	Input	Output	Weight
CEDLTC00104	Dimmable DALI	25	110-240V 50-60 Hz	350mA constant 74V Max	net kg 0.15



# Driver for Spillray LED 12V

## STANDARD

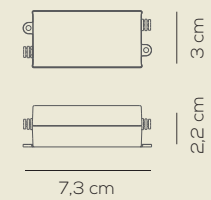

### DRIVER 12V / LED 1+5 x 1,5W

Code	Product	W Max	Input	Output	Weight
CEDMWC00200	Standard not dimmable	8	100-264Vac 50-60 Hz	12VDC constant 0,67mA	net kg 0,09

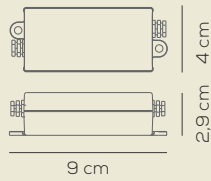

### DRIVER 12V / LED 1+8 x 1,5W

Code	Product	W Max	Input	Output	Weight
CEDMWC00201	Standard not dimmable	12	100-264Vac 50-60 Hz	12VDC constant 1A	net kg 0,08



# Driver for U-Light 24V - dimmable 1-10V

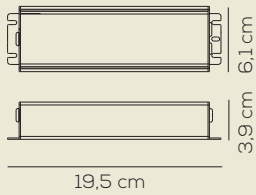

### DRIVER 24V

Code	Product	W Max	Input	Output	Weight
CEDMWC00202	Dimmable 1-10V	80	100-305Vac 50-60 Hz	24VDC constant 3,4A	net kg 0,9

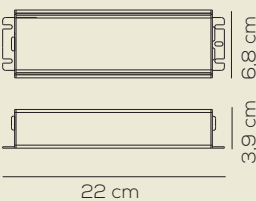

### DRIVER 24V

Code	Product	W Max	Input	Output	Weight
CEDMWC00203	Dimmable 1-10V	100	100-305Vac 50-60 Hz	24VDC constant 4A	net kg 1,2



# Driver for U-Light 24V - dimmable DALI

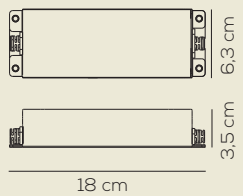

### DRIVER 24V

Code	Product	W Max	Input	Output	Weight
CEDMWC00204	Dimmable DALI	75	100-305Vac 50-60 Hz	24VDC constant 3,15A	net kg 0,8

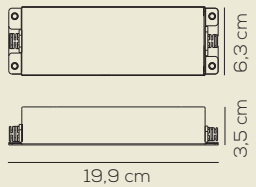

### DRIVER 24V

Code	Product	W Max	Input	Output	Weight
CEDMWC00205	Dimmable DALI	100	100-305Vac 50-60 Hz	24VDC constant 4A	net kg 0,85



# TRANSFORMER 12V

## DIMMABLE PHASE CUT TRANSFORMER

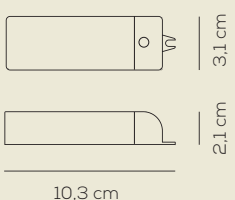

Code	Product	W Max	Input	Output	Weight
TR60PRIMULA	Dimmable Phase Cut	60	230-240V 50-60 Hz	12VAC	net kg 0,06



Gli articoli in rosso sono disponibili solo fino ad esaurimento scorte. Articles in red are available until sold out.

# Legenda / Legend



I nostri prodotti sono sottoposti alle prove di sicurezza elettrica e conformi alle Direttive Comunitarie Europee EN60598-1, LVD 2006/95/EC, EMC 2004/108/EC (ove previsto).

*Our products undergo electric safety tests and comply with ECC Directive EN60598-1, LVD 2006/95/EC, EMC 2004/108/EC (where provided).*

I dati nominali di flusso (lm) e di efficienza (lm/W) sono riferiti rispettivamente alle sorgenti LED e alle sorgenti LED più l'assorbimento della PSU.

*Nominal flux (lm) and efficacy (lm/W) of the products are estimated on the LED sources and the LED sources plus the PSU absorption.*

I dati riportati sono puramente indicativi; è possibile che siano riportati degli errori di stampa. Axo Light può apporre modifiche di qualsivoglia tipo agli apparecchi, ai dati e alle relative istruzioni senza preavviso alcuno. Axo Light non presta garanzia legale relativamente all'accuratezza dei dati riportati nel presente listino.

*The details given here are intended purely as guidance as errors may have occurred during the printing process. Axo Light may make alterations of any type to the light fittings, data and relevant instructions without notice. Axo Light does not provide legal guarantee regarding the accuracy of the data provided in this price list.*



## CLASSE 1

Solo isolamento fondamentale; le parti conduttrici accessibili sono collegate ad un conduttore di terra. Messa a terra obbligatoria.

*Basic insulation, accessible conductors are earthed. Earthing is compulsory.*



## CLASSE 2

Sistema a doppio isolamento; messa a terra esclusa.

*Double insulation. Earthing: excluded.*



## CLASSE 3

Apparecchio in cui la protezione contro la scossa elettrica si basa sulla alimentazione a bassissima tensione di sicurezza.

*Appliance in which protection against electrical shock is guaranteed by the extremely low voltage power supply.*

## PSU

Alimentatore.

*Power Supply Unit.*



Dimmerabile. Dimmer incluso.

*Dimmable. Dimmer included.*

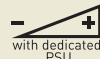

Dimmerabile solo con driver dedicato.

*Dimmable only with dedicated power supply unit.*



Articolo dimmerabile 1-10V.

*Dimmable 1-10V.*



Interfacciabile con sistema DALI.

*Interfaceable with DALI system.*



Dimmerabile a taglio di fase.

*Dimmable phase cut.*

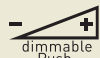

Articolo dimmerabile Push

*Dimmable Push*

## 220-240V<sub>AC</sub> LED

Prodotto con LED integrato a tensione di rete.

*Product equipped with Integrated LED for the mains voltage.*

Misure dei disegni in cm.

Schede tecniche e files 3D verranno implementati e resi disponibili nel sito [www.axolight.it](http://www.axolight.it) nella sezione PRODOTTI > AXO LIGHT sotto la voce "dimensioni / dati tecnici" di ogni collezione.

## LED

Prodotto con LED integrato.

*Integrated LED product.*

## LED

Prodotto per sola lampadina a LED.

*Product for LED light bulbs only.*

## +LED

Prodotto con lampadine LED o convenzionali.

*Product for LED or conventional light bulbs.*

*Measures of the drawings in cm.*

*Technical sheets and the 3D files will be updated and available at [www.axolight.it](http://www.axolight.it) in the section PRODUCTS > AXO LIGHT and under the link "dimension / technical data", available under each collection.*

## IPXY

Grado di protezione contro corpi solidi X - e contro i liquidi Y.

*Protection rating against solid bodies X - against liquids Y.*

## CRI

Indice di resa di colore.

*Colour rendering index.*

## EEL compatibility

Gli apparecchi Axo Light sono compatibili con lampadine etichettate con le classi energetiche del regolamento ENERGY LABELLING eventualmente disponibili in commercio e previa verifica dimensionale. La classe energetica in grassetto è quella della lampadina con cui è venduto l'apparecchio. I prodotti presenti a listino con il simbolo **LED** sono muniti di lampade a LED integrate A, A+, A++ non sostituibili. Le informazioni qui riportate riguardo le classi energetiche delle lampadine non sono esaustive di tutti i tipi effettivamente reperibili sul mercato dell'Area Economica Europea.

Elenco EELc al seguente link:

[www.axolight.eu/eelc-axolight.pdf](http://www.axolight.eu/eelc-axolight.pdf)

*The Axo Light luminaires are compatible with bulbs - if available in the market and previously checked as regards their dimensions - labelled with the energy classes of the ENERGY LABELLING regulation. The energy class letter in bold format is related to the bulb supplied together with the specific article. The products with the symbol **LED** are equipped with built-in LED lamps A, A+, A++ that cannot be changed. The information regarding the energy classes of the bulbs are not exhaustive about the actual whole range available in the Economic European Area market.*

EELc list at the following link:

[www.axolight.eu/eelc-axolight.pdf](http://www.axolight.eu/eelc-axolight.pdf)

## ADA

Prodotto conforme alla normativa USA A.D.A. (protruding objects).

*Product conforms to the USA A.D.A. standards (protruding objects).*

Il peso indicato si riferisce al peso netto degli articoli. Il volume indicato si riferisce al volume degli imballi degli articoli.

*The weight indications refer to the net weight of the items. The volume indications refer to the volume of the packing boxes of the items.*





**CONCEPT AND GRAPHIC DESIGN**

design-associati.it

**ART DIRECTION**

Magdalena Kirova

**MAIN PHOTOGRAPHERS**

Studio Step, Maximilian Pramatarov

**RENDERING**

Axolight Lab, Nicolò Lamon, Fabrizio Cettina

**PRINT**

Printed in Italy

Axo Light si riserva il diritto di apportare ai modelli, senza alcun preavviso, qualsiasi modifica ritenesse opportuna.

Axo Light non risponde per eventuali danni a persone o cose causati da una non corretta installazione dei propri apparecchi d'illuminazione. I dati riportati sono puramente indicativi; è possibile che siano riportati degli errori di stampa.

*Axo Light reserves itself the right to introduce any changes to its own models, without prior notice. Axo Light is not liable for injuries or damage due to the incorrect installation of its fixtures. The details given here are intended purely as guidance as errors may have occurred during the printing process.*

Le schede tecniche dei prodotti Axo Light sono scaricabili direttamente dal nostro sito: [www.axolight.it](http://www.axolight.it)

*Axo Light technical sheets can be downloaded directly from our website: [www.axolight.it](http://www.axolight.it)*



axolight.it  
axolightusa.com

**AXO LIGHT SRL**

via Moglianese 44

30037 Scorzè

Venezia (Italy)

t +39 041 5845193

[axolight@axolight.it](mailto:axolight@axolight.it)

**AXO LIGHT USA INC**

22 Shelter Rock Lane STE# 104

Danbury, CT 06810, USA

t +1 (203) 730 0452

[info@axolightusa.com](mailto:info@axolightusa.com)