

INI

Outdoor lighting
Catalogue 22

novantadieci[®]



OUT

INDEX	
ANALYTICAL	3
BY CATEGORY	5
PRODUCTS	29
MATERIALS	253
DESIGNERS	261
GENERAL INFO	277

ANALYTICAL INDEX

1090 WING		P.36	1124A SEGNALINEA	NEW	P.134
1090A WING Q	NEW	P.36	1124C SEGNALINEA SMALL	NEW	P.134
1090B WING Q BIG	NEW	P.37			
1090C WING X	NEW	P.38	1202A DEFINE	NEW	P.72
1091 QUAREO		P.44	1203 SILOS	NEW	P.93
1091B QUAREO X		P.44	1205 KERIS	NEW	P.77
1091C QUAREO Y		P.45	1206 ARCIERE	NEW	P.81
1092 SCUBO		P.51			
1093 ELLE		P.143	1301A CAVE SMALL		P.219
1093B ELLE SMALL		P.143	1301B CAVE		P.219
1094 SCUBO C		P.88	1301C CAVE BIG		P.220
1094B SCUBO C SMALL	NEW	P.88	1301D CAVE X		P.220
1094C SCUBO C FLAT	NEW	P.89	1301E CAVE S		P.221
1095B MEZZARCO		P.57	1302A DIAGO		P.230
1096B MATT		P.51	1303 ASTRON CERCHIO		P.230
1096C MATT X		P.52	1304A HINT SMALL		P.236
1096D MATT Y	NEW	P.52	1304B HINT		P.236
1097 MATT BIG		P.53	1304C HINT BIG		P.237
1098 LEVICO WALL		P.62	1305A ASTRON SMALL		P.231
1098B LEVICO WALL S	NEW	P.62	1305B ASTRON		P.231
1102 SER		P.101	HOUSE NUMBERS & LETTERS		P.245
1103A MONO		P.150	NUMERI CIVICI E LETTERE		
1103B DOUBLE		P.150	HAUSNUMMERN E LETTERE		
1103D DOUBLE SMALL	NEW	P.151	NUMÉROS DE MAISON E LETTERE		
1104 DOMINO		P.67			
1105A BEAN SMALL		P.105	ACCESSORIES		P.251
1105B BEAN		P.156	ACCESSORI		
1105C BEAN BIG		P.156	ZUBEHÖRE		
1106A MINÙ		P.163	ACCESSOIRES		
1107 COBRA		P.167			
1108A ZETA SMALL		P.175			
1108B ZETA		P.175			
1109 ERCOLE		P.181			
1110A LEVICO SMALL		P.186			
1110B LEVICO		P.186			
1112A OOLITE SMOOTH	NEW	P.192			
1112B OOLITE GRIT	NEW	P.192			
1112C OOLITE ROUGH	NEW	P.193			
1114A TOOTH SMALL	NEW	P.110			
1114B TOOTH	NEW	P.110			
1116A ALFIERE SMALL		P.115			
1116B ALFIERE		P.199			
1117 VIMA		P.120			
1119 PASSO	NEW	P.125			
1120 CHARTA	NEW	P.129			
1121 ANTHEA	NEW	P.203			
1123A LINEA	NEW	P.207			
1123B BILINEA	NEW	P.207			
1123C LINEA SMALL	NEW	P.208			
1123D BILINEA SMALL	NEW	P.208			

INDEX BY CATEGORY

WALL LIGHTING
A PARETE
WANDLEUCHTEN
APPLIQUES

1090 WING
P.36

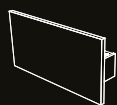

1090A WING Q
P.36 NEW



1090B WING Q BIG
P.37 NEW



1090C WING X
P.38 NEW



1091 QUAREO
P.44

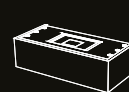

1091B QUAREO X
P.44



1091C QUAREO Y
P.45

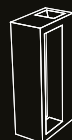

1092 SCUBO
P.51



1095B MEZZARCO
P.57



1096B MATT
P.51



1096C MATT X
P.52



1096D MATT Y
P.52 NEW



1097 MATT BIG
P.53



1098 LEVICO WALL
P.62



1098B LEVICO WALL S
P.62 NEW



1104 DOMINO
P.67



1202A DEFINE
P.72 NEW



1205 KERIS
P.77 NEW



1206 ARCIERE
P.81 NEW



CEILING LIGHTING
A PLAFONE
DECKENLEUCHTEN
PLAFONNIERS

1094 SCUBO C
P.88



1094B SCUBO C SMALL
P.88 NEW



1094C SCUBO C FLAT
P.89 NEW

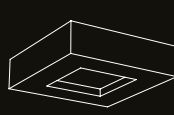























1203 SILOS
P.93 NEW



PATHMARKERS
 SEGNAPASSI
 ORIENTIERUNGSBELEUCHTUNG
 BALISAGES

1102 SER P.101	1105A BEAN SMALL P.105	1114A TOOTH SMALL P.110	1114B TOOTH P.110	1116A ALFIERE SMALL P.115	1117 VIMA P.120
					
1119 PASSO P.125	1120 CHARTA P.129	1124A SEGNALINEA P.134	1124C SEGNALINEA SMALL P.134		
					

BOLLARDS
 PALETTI
 POLLERLEUCHTEN
 BORNES

1093 ELLE P.143	1093B ELLE SMALL P.143	1103A MONO P.150	1103B DOUBLE P.150	1103D DOUBLE SMALL P.151	1105B BEAN P.156
					
1105C BEAN BIG P.156	1106A MINÙ P.163	1107 COBRA P.167	1108A ZETA SMALL P.175	1108B ZETA P.175	1109 ERCOLE P.181
					
1110A LEVICO SMALL P.186	1110B LEVICO P.186	1112A OOLITE SMOOTH P.192	1112B OOLITE GRIT P.192	1112C OOLITE ROUGH P.193	1116B ALFIERE P.199
					
1121 ANTHEA P.203	1123A LINEA P.207	1123B BILINEA P.207	1123C LINEA SMALL P.208	1123D BILINEA SMALL P.208	
					

WALL RECESSED LIGHTING
 INCASSO A PARETE
 WAND-EINBAULEUCHTEN
 ENCASTRÉS MURAUX

1301A CAVE SMALL
 P.219



1301B CAVE
 P.219



1301C CAVE BIG
 P.220



1301D CAVE X
 P.220

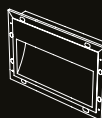

1301E CAVE S
 P.221



1302A DIAGO
 P.230



1303 ASTRON CERCHIO
 P.230



1304A HINT SMALL
 P.236



1304B HINT
 P.236



1304C HINT BIG
 P.237



1305A ASTRON SMALL
 P.231



1305B ASTRON
 P.231



HOUSE NUMBERS AND LETTERS
 NUMERI CIVICI E LETTERE
 HAUSNUMMERN E LETTERE
 NUMÉROS DE MAISON E LETTERE

N 0-9
 P.245



A-D
 P.246 NEW



ACCESSORIES
 ACCESSORI
 ZUBEHÖRE
 ACCESSOIRES

1103K
 P.251

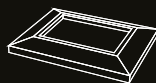

1105K
 P.251

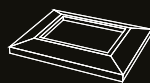

1106K
 P.251



1110K
 P.251



OUR NATURE IS BOUND TO NATURE

EN In the town of Nove, the Brenta river splits into several branches, forming sandy islets. Our journey which, one step at a time, takes us to the Oasis of the Brenta, begins on these pieces of emerged land. Along the way the stones become pebbles, sand, then water and vice versa. Observing the relationship between elements, and the way they change with the passing of the seasons, we find the inspiration that feeds the creative richness of the transformation process of raw materials. Marble dust, quartz, and fluvial sands are the organic materials that arise from and return to nature, carefully shaped by 9010novantadiecì to make designer lighting.

IT A Nove il fiume Brenta si divide in diversi rami che formano isolette sabbiose. In queste porzioni di terra emersa ha inizio il nostro viaggio che, passo dopo passo, ci porta all'Oasi del Brenta. Lungo il percorso i sassi diventano ciottoli, sabbia, poi acqua e viceversa. Osservando la relazione tra gli elementi e il loro mutamento nel susseguirsi delle stagioni troviamo l'ispirazione, che diventa ricchezza creativa nel processo di trasformazione della materia prima. Polveri di marmi, sabbie quarzose e fluviali sono i materiali organici che nascono dalla natura e ad essa ritornano, modellati con cura da 9010 per farne illuminazioni di design.

DE In Nove teilt sich der Fluss Brenta in verschiedene Arme, die sandige Inseln bilden. In diesen so entstandenen Landportionen beginnt unsere Reise, die uns Schritt für Schritt in die Brenta-Oase führt. Entlang des Weges werden die Steine zu Kieselsteinen, Sand und schließlich Wasser und umgekehrt. Durch die Betrachtung der Beziehung zwischen den Elementen und ihres Wandels im Lauf der Jahreszeiten finden wir die Inspiration, die im Verwandlungsprozess des Rohstoffs zur kreativen Vielfalt wird. Marmorpulver, Quarz- und Flusssand sind organische Materialien, die in der Natur entstehen und dorthin zurückkehren, nachdem sie sorgfältig von 9010novantadiecì zu Designbeleuchtungen modelliert wurden.

FR À Nove, le fleuve Brenta se divise en plusieurs bras qui forment des îlots de sable. C'est dans ces portions de terre émergée que commence notre voyage qui, étape par étape, nous conduit à l'oasis du Brenta. En cours de route, les pierres deviennent des galets, du sable, puis de l'eau et vice versa. En observant la relation entre les éléments et leur mutation dans la succession des saisons, nous trouvons l'inspiration, qui devient une richesse créative dans le processus de transformation de la matière première. Les poussières de marbre, les sables de quartz et de rivière sont les matériaux organiques qui naissent de la nature et y retournent, modelés avec soin par 9010novantadiecì pour réaliser des éclairages design.





































PRODUCTS

WALL LIGHTING

CEILING LIGHTING

PATHMARKERS

BOLLARDS

WALL RECESSED LIGHTING

HOUSE NUMBERS AND LETTERS

ACCESSORIES

WALL LIGHTING
A PARETE
WANDLEUCHTEN
APPLIQUES



1090 WING

1090A WING Q

1090B WING Q BIG

1090C WING X

Designed by 9010novantadiecì

EN A basic rectangular shape in its purest form that can be positioned on the wall thanks to its built in mount. Depending on how it is installed, light passes through its body, spreading either upward or downward, creating pleasant and diffused indirect lighting.

IT La figura elementare del rettangolo nella sua forma pura risulta sospesa rispetto alla parete grazie al supporto installato. La luce attraversa il suo corpo e si dirige verso l'alto o verso il basso, a seconda dell'installazione, per generare un'illuminazione indiretta piacevole e diffusa.

DE Die elementare Figur des Rechtecks in seiner reinsten Form wirkt dank der installierten Halterung wie vor der Wand schwebend. Das Licht durchquert den Körper und richtet sich je nach der Installation nach oben oder unten und sorgt für eine angenehme, diffuse indirekte Beleuchtung.

FR La figure élémentaire du rectangle dans sa forme pure est suspendue par rapport au mur grâce au support installé. La lumière traverse son corps et est dirigée vers le haut ou vers le bas, selon l'installation, pour générer un éclairage indirect agréable et diffus.



Art. 1090-396-3012



Art. 1090A-395-30174

○
 Bi-emission (up and down)
 Biemissione (sopra e sotto)
 Zweiflammig (oben und unten)
 Bi-émission (vers le haut et vers le bas)

Art. 1090A-395-30173

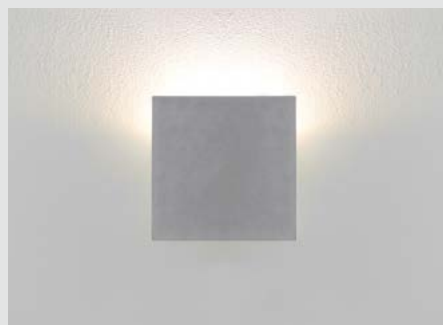

○
 Mono-emission (up or down)
 Monoemissione (sopra o sotto)
 Einflammig (oben oder unten)
 Mono-émission (vers le haut ou vers le bas)



Art.
1090

Wall lighting
 A parete
 Wandleuchten
 Appliques

9010novantadiecì Outdoor



Art. 1090-396-3012

Art. 1090-396-3012



○
Mono-emission (up or down)
Monoemissione (sopra o sotto)
Einflamig (oben oder unten)
Mono-émission (vers le haut ou vers le bas)



1090 WING

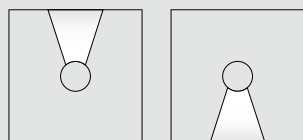
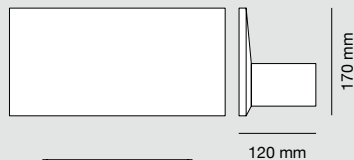

Article code* / Codice articolo* / Artikelnummer* / Code de l'article*
1090-396-3012

Weight / Peso / Gewicht / Poids
3,6 Kg

Materials / Materiali / Materialien / Matériaux
BETALY®

Light source / Sorgente luminosa / Leuchtmittel / Source lumineuse
LED 10W

Tension / Tensione / Spannung / Tension
220-240Vac 50/60Hz
ON/OFF Driver included inside / Driver ON/OFF incluso all'interno
Inklusive ON/OFF Betriebsgerät / Alimentation ON/OFF incluse

Colour temperature / Tonalità / Farbtemperatur / Température de couleur
3000°K

Lumen
800lm

CRI
80

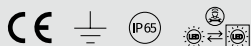

1090A WING Q

NEW

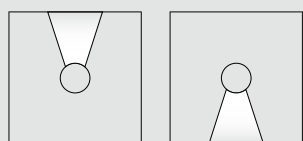
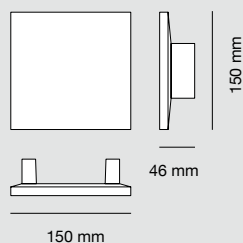

Article code* / Codice articolo* / Artikelnummer* / Code de l'article*
1090A-396-30173

Weight / Peso / Gewicht / Poids
1,0 Kg

Materials / Materiali / Materialien / Matériaux
BETALY®

Light source / Sorgente luminosa / Leuchtmittel / Source lumineuse
LED 6W

Tension / Tensione / Spannung / Tension
24Vdc
Remote constant voltage driver is required / Necessita di alimentatore remoto tensione costante
Benötigt externe Spannungsversorgung / Alimentateur à tension constante déporté nécessaire

Colour temperature / Tonalità / Farbtemperatur / Température de couleur
3000°K

On request available in other color temperatures / Disponibile su richiesta anche con altre temperature colore
Auf Anfrage in anderen Farbtemperaturen erhältlich / Sur demande disponible dans d'autres températures de couleur

Lumen
800lm

CRI
80



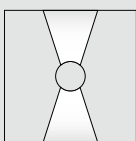
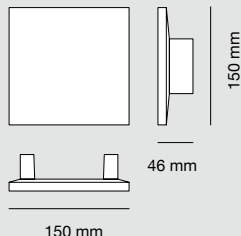

Article code* / Codice articolo* / Artikelnummer* / Code de l'article*
1090A-396-30174

Weight / Peso / Gewicht / Poids
1,0 Kg

Materials / Materiali / Materialien / Matériaux
BETALY®

Light source / Sorgente luminosa / Leuchtmittel / Source lumineuse
LED 12W

Tension / Tensione / Spannung / Tension
24Vdc

Remote constant voltage driver is required / Necessita di alimentatore remoto tensione costante
Benötigt externe Spannungsversorgung / Alimentateur à tension constante déporté nécessaire

Colour temperature / Tonalità / Farbtemperatur / Température de couleur
3000°K

On request available in other color temperatures / Disponibile su richiesta anche con altre temperature colore
Auf Anfrage in anderen Farbtemperaturen erhältlich / Sur demande disponible dans d'autres températures de couleur

Lumen
1600lm

CRI
80



1090B WING Q BIG

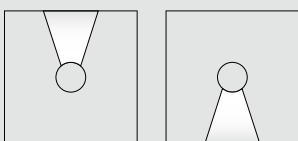
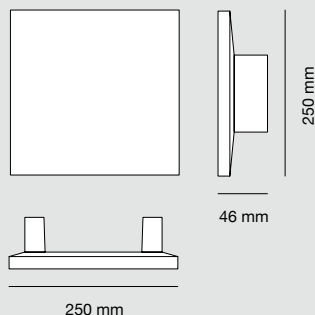

Article code* / Codice articolo* / Artikelnummer* / Code de l'article*
1090B-396-30175

Weight / Peso / Gewicht / Poids
1,2 Kg

Materials / Materiali / Materialien / Matériaux
BETALY®

Light source / Sorgente luminosa / Leuchtmittel / Source lumineuse
LED 12W

Tension / Tensione / Spannung / Tension
24Vdc

Remote constant voltage driver is required / Necessita di alimentatore remoto tensione costante
Benötigt externe Spannungsversorgung / Alimentateur à tension constante déporté nécessaire

Colour temperature / Tonalità / Farbtemperatur / Température de couleur
3000°K

On request available in other color temperatures / Disponibile su richiesta anche con altre temperature colore
Auf Anfrage in anderen Farbtemperaturen erhältlich / Sur demande disponible dans d'autres températures de couleur

Lumen
1600lm

CRI
80



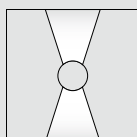
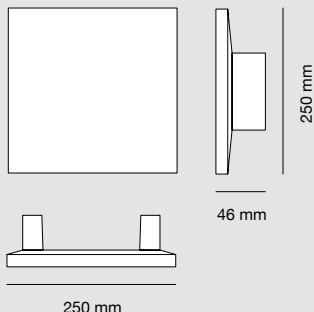

Article code* / Codice articolo* / Artikelnummer* / Code de l'article*
1090B-396-30176

Weight / Peso / Gewicht / Poids
1,2 Kg

Materials / Materiali / Materialien / Matériaux
BETALY®

Light source / Sorgente luminosa / Leuchtmittel / Source lumineuse
LED 24W

Tension / Tensione / Spannung / Tension
24Vdc

Remote constant voltage driver is required / Necessita di alimentatore remoto tensione costante
Benötigt externe Spannungsversorgung / Alimentateur à tension constante déporté nécessaire

Colour temperature / Tonalità / Farbtemperatur / Température de couleur
3000°K

On request available in other color temperatures / Disponibile su richiesta anche con altre temperature colore
Auf Anfrage in anderen Farbtemperaturen erhältlich / Sur demande disponible dans d'autres températures de couleur

Lumen
3200lm

CRI
80



1090C WING X

NEW

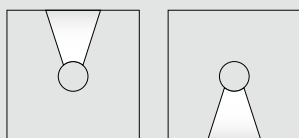
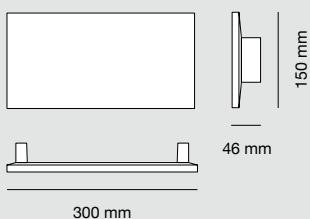

Article code* / Codice articolo* / Artikelnummer* / Code de l'article*
1090C-396-30175

Weight / Peso / Gewicht / Poids
1,0 Kg

Materials / Materiali / Materialien / Matériaux
BETALY®

Light source / Sorgente luminosa / Leuchtmittel / Source lumineuse
LED 12W

Tension / Tensione / Spannung / Tension
24Vdc

Remote constant voltage driver is required / Necessita di alimentatore remoto tensione costante
Benötigt externe Spannungsversorgung / Alimentateur à tension constante déporté nécessaire

Colour temperature / Tonalità / Farbtemperatur / Température de couleur
3000°K

On request available in other color temperatures / Disponibile su richiesta anche con altre temperature colore
Auf Anfrage in anderen Farbtemperaturen erhältlich / Sur demande disponible dans d'autres températures de couleur

Lumen
1600lm

CRI
80



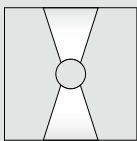
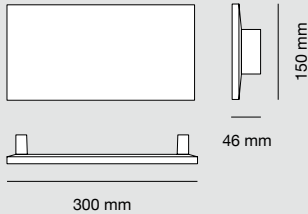

Article code* / Codice articolo* / Artikelnummer* / Code de l'article*
1090C-396-30176

Weight / Peso / Gewicht / Poids
1,0 Kg

Materials / Materiali / Materialien / Matériaux
BETALY®

Light source / Sorgente luminosa / Leuchtmittel / Source lumineuse
LED 24W

Tension / Tensione / Spannung / Tension
24Vdc

Remote constant voltage driver is required / Necessita di alimentatore remoto tensione costante
Benötigt externe Spannungsversorgung / Alimentateur à tension constante déporté nécessaire

Colour temperature / Tonalità / Farbtemperatur / Température de couleur
3000°K

On request available in other color temperatures / Disponibile su richiesta anche con altre temperature colore
Auf Anfrage in anderen Farbtemperaturen erhältlich / Sur demande disponible dans d'autres températures de couleur

Lumen
3200lm

CRI
80



*Colors of the material / Colori del materiale / Farben der Materialien / Couleurs des matériaux



On request available in white dyeable color / Disponibile su richiesta in finitura bianca colorabile
Auf Anfrage in weißer einfärbbarer Farbe erhältlich / Sur demande disponible en couleur blanche teintable

Accessories / Accessori / Zubehöre / Accessoires

Power supply code / Codice alimentatore / Netzgerät Code / Code driver	026.258	026.259	026.260
Power / Potenza / Leistung / Puissance	12W - 24Vdc	36W - 24Vdc	60W - 24Vdc
Protection degree / Grado di protezione / Schutzklasse / Degré de protection	IP20	IP20	IP20
Measurements / Misure / Abmessungen / Dimensions	112 x 45 x 16 mm	169 x 57 x 19 mm	169 x 57 x 19 mm
Dimming / Dimmerazione / Dimmung / Variateur de lumière	ON/OFF	ON/OFF	ON/OFF
Input / ingresso / Eingang / Entrée	IN 220-240V~	IN 220-240V~	IN 220-240V~
Power supply code / Codice alimentatore / Netzgerät Code / Code driver	026.301	026.209	026.190
Power / Potenza / Leistung / Puissance	24W - 24Vdc	60W - 24Vdc	Max 288W - 24Vdc
Protection degree / Grado di protezione / Schutzklasse / Degré de protection	IP20	IP20	IP20
Measurements / Misure / Abmessungen / Dimensions	164 x 38 x 25 mm	127 x 82 x 30 mm	164 x 38 x 25 mm
Dimming / Dimmerazione / Dimmung / Variateur de lumière	DIM PUSH / DALI / 0-10V / 1-10V	DIM PUSH/1-10V	DIMMER DALI/PUSH/0-10V/1-10V
Input / ingresso / Eingang / Entrée	IN 220-240V~	IN 220-240V~	IN 12-48Vdc

1091 QUAREO

1091B QUAREO X

1091C QUAREO Y

Designed by 9010novantadiecì

EN This line of outdoor wall lamps comes in a compact parallelepiped shape. The lighting element runs along QUAREO's entire length, and depending on how the structure is mounted, light may be diffused upward, downward, or laterally.

IT Questa linea di applique da esterno si presenta nella forma di un parallelepipedo compatto. Il corpo luminoso di QUAREO si estende lungo l'intera porzione orizzontale e, a seconda di come si monti la struttura, diffonde la luce verso l'alto, il basso o lateralmente.

DE Diese Wandleuchtenlinie für den Außenbereich hat die Form eines kompakten Quaders. Der Leuchtkörper von QUAREO breitet sich entlang der gesamten horizontalen Portion aus und verbreitet das Licht je nachdem, wie die Struktur montiert wird, nach oben, unten oder seitlich.

FR Cette ligne d'appliques d'extérieur prend la forme d'un parallélépipède compact. Le corps lumineux de QUAREO s'étend sur toute la partie horizontale et, selon le mode de montage de la structure, il diffuse la lumière vers le haut, le bas ou les côtés.



Art. 1091C-396-30160



Art. 1091-396-3012

○
 Mono-emission (up or down)
 Monoemissione (sopra o sotto)
 Einflämmig (oben oder unten)
 Mono-émission (vers le haut ou vers le bas)

○
 Bi-emission (above and below / right and left)
 Biemissione (sopra e sotto / destra e sinistra)
 Zweiflammig (oben und unten / rechts und links)
 Bi-émission (au-dessus et en dessous / droite et gauche)

Art. 1091B-396-30160



Art. 1091C-396-30160



○
Bi-emission (up and down)
Biemissione (sopra e sotto)
Zweiflämmig (oben und unten)
Bi-émission (vers le haut et vers le bas)



Art. 1091B-394-30160

1091 QUAREO

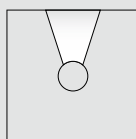
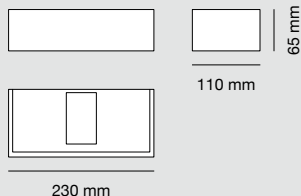

Article code* / Codice articolo* / Artikelnummer* / Code de l'article*
1091-396-3012

Weight / Peso / Gewicht / Poids
1,6 Kg

Materials / Materiali / Materialien / Matériaux
BETALY®

Light source / Sorgente luminosa / Leuchtmittel / Source lumineuse
LED 10W

Tension / Tensione / Spannung / Tension
220-240Vac 50/60Hz

ON/OFF Driver included inside / Driver ON/OFF incluso all'interno
Inklusive ON/OFF Betriebsgerät / Alimentation ON/OFF incluse

Colour temperature / Tonalità / Farbtemperatur / Température de couleur
3000°K

Lumen
800lm

CRI
80

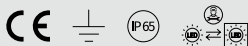

1091B QUAREO X

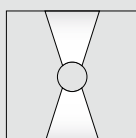
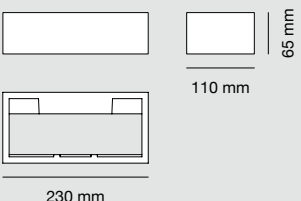

Article code* / Codice articolo* / Artikelnummer* / Code de l'article*
1091B-396-30160

Weight / Peso / Gewicht / Poids
1,6 Kg

Materials / Materiali / Materialien / Matériaux
BETALY®

Light source / Sorgente luminosa / Leuchtmittel / Source lumineuse
LED 6W

Tension / Tensione / Spannung / Tension
24Vdc

Remote constant voltage driver is required / Necessita di alimentatore remoto tensione costante
Benötigt externe Spannungsversorgung / Alimentateur à tension constante déporté nécessaire

Colour temperature / Tonalità / Farbtemperatur / Température de couleur
3000°K

On request available in other color temperatures / Disponibile su richiesta anche con altre temperature colore
Auf Anfrage in anderen Farbtemperaturen erhältlich / Sur demande disponible dans d'autres températures de couleur

Lumen
800lm

CRI
80



1091C QUAREO Y

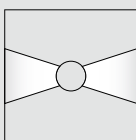
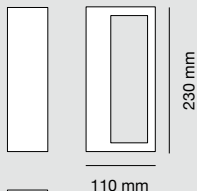

Article code* / Codice articolo* / Artikelnummer* / Code de l'article*
1091C-396-30160

Weight / Peso / Gewicht / Poids
1,9 Kg

Materials / Materiali / Materialien / Matériaux
BETALY®

Light source / Sorgente luminosa / Leuchtmittel / Source lumineuse
LED 6W

Tension / Tensione / Spannung / Tension
24Vdc

Remote constant voltage driver is required / Necessita di alimentatore remoto tensione costante
Benötigt externe Spannungsversorgung / Alimentateur à tension constante déporté nécessaire

Colour temperature / Tonalità / Farbtemperatur / Température de couleur
3000°K

On request available in other color temperatures / Disponibile su richiesta anche con altre temperature colore
Auf Anfrage in anderen Farbtemperaturen erhältlich / Sur demande disponible dans d'autres températures de couleur

Lumen
800lm

CRI
80



*Colors of the material / Colori del materiale / Farben der Materialien / Couleurs des matériaux



On request available in white dyeable color / Disponibile su richiesta in finitura bianca colorabile
Auf Anfrage in weißer einfärbbarer Farbe erhältlich / Sur demande disponible en couleur blanche teintable

Accessories / Accessori / Zubehöre / Accessoires

	026.258	026.259	026.301
Power supply code / Codice alimentatore / Netzgerät Code / Code driver	12W - 24Vdc	36W - 24Vdc	24W - 24Vdc
Power / Potenza / Leistung / Puissance	IP20	IP20	IP20
Protection degree / Grado di protezione / Schutzklasse / Degré de protection	112 x 45 x 16 mm	169 x 57 x 19 mm	164 x 38 x 25 mm
Measurements / Misure / Abmessungen / Dimensions	ON/OFF	ON/OFF	DIM PUSH / DALI / 0-10V / 1-10V
Dimming / Dimmerazione / Dimmung / Variateur de lumière	IN 220-240V~	IN 220-240V~	IN 220-240V~
Input / ingresso / Eingang / Entrée			

1092 SCUBO
1096B MATT
1096C MATT X
1096D MATT Y
1097 MATT BIG

Designed by 9010novantadiecì

EN A family of cube-shaped or parallelepiped-shaped lamps characterized by compact volumes. Minimal and clean lines make SCUBO and MATT versatile accessories. The central body emanates beams of mono-directional or bi-directional light that create an extremely efficient scenic light on the walls.

IT Una famiglia di lampade a forma di cubo o parallelepipedo caratterizzata da volumi compatti. La linea minimale e pulita rende SCUBO e MATT complementi versatili. Il corpo centrale emana fasci di luce monodirezionale o bidirezionale che creano sulle pareti una luce scenica dalla grande efficienza.

DE Eine würfel- oder quaderförmige Lampenfamilie mit dem Merkmal von kompakten Volumen. Dank der minimalistischen, puren Linie sind SCUBO und MATT vielseitige Einrichtungselemente. Der mittlere Körper gibt Lichtstrahlen in eine oder zwei Richtungen ab, die auf den Wänden ein hochwirksames szenisches Licht hervorbringen.

FR Famille de lampes de forme cubique ou parallélépipédique se distinguant par des volumes compacts. Les lignes minimalistes et épurées font de SCUBO et MATT des compléments polyvalents. Le corps central émet des faisceaux lumineux unidirectionnels ou bidirectionnels qui créent un éclairage scénique très efficace sur les murs.



Art. 1096C-396-30160

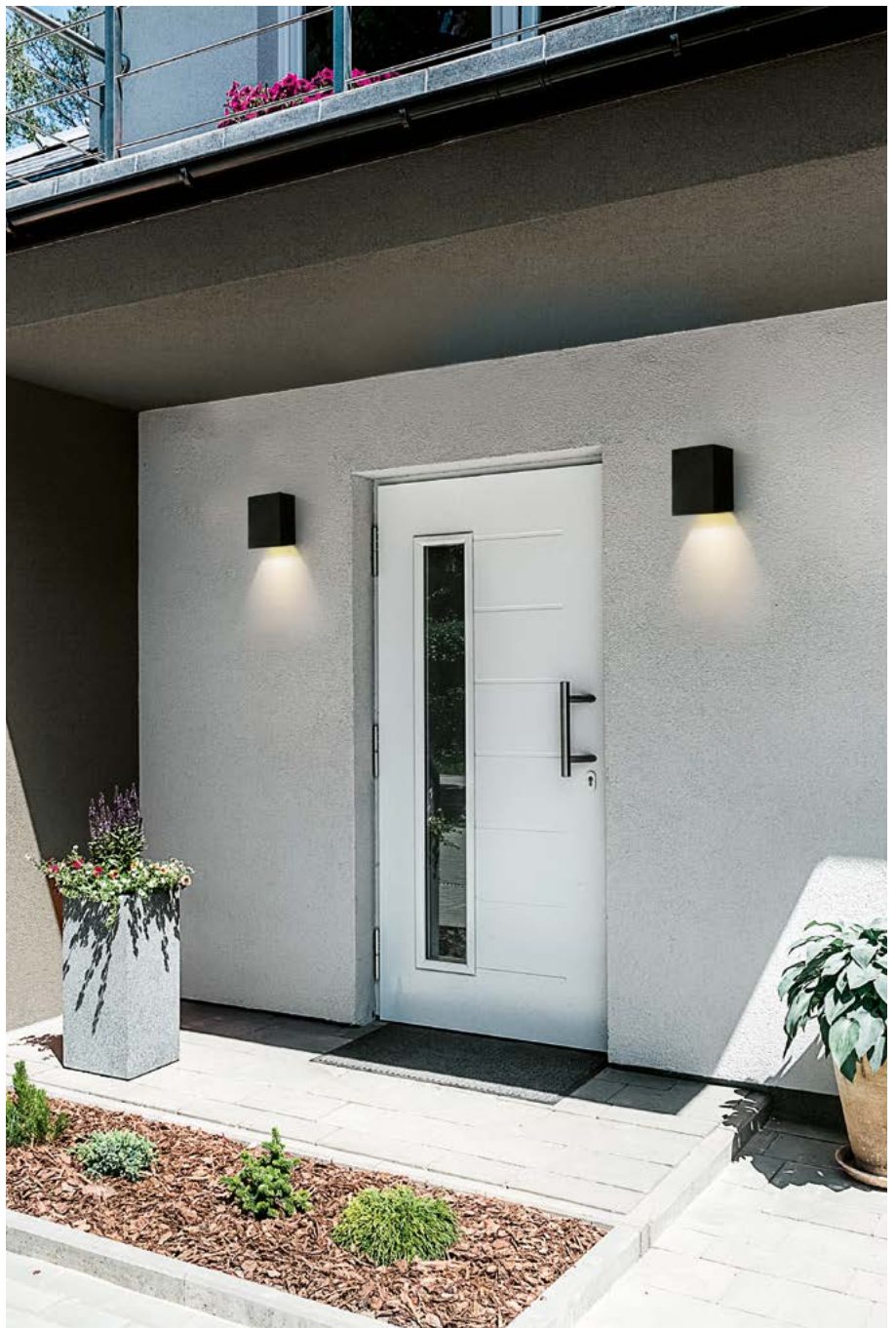

Art. 1097-396-30159

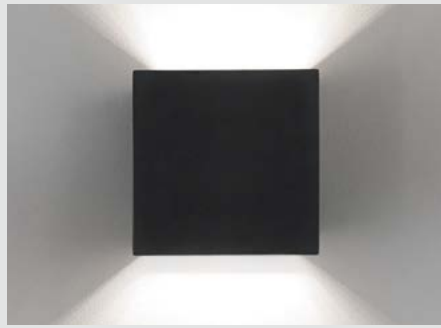

○
 Bi-emission (up and down)
 Biemissione (sopra e sotto)
 Zweiflammig (oben und unten)
 Bi-émission (vers le haut et vers le bas)

Art. 1092-396-3012

○
 Bi-emission (above and below / right and left)
 Biemissione (sopra e sotto / destra e sinistra)
 Zweiflammig (oben und unten / rechts und links)
 Bi-émission (au-dessus et en dessous / droite et gauche)

Art. 1096B-396-30160



Art. 1096C-396-30160





Art. 1097-394-30159

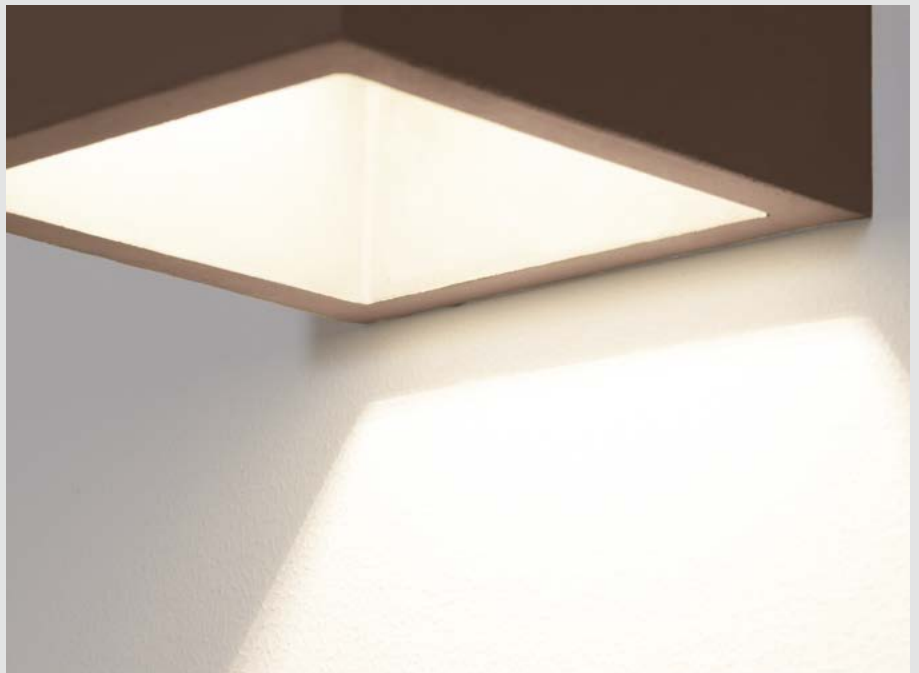

Art.
1092, 1096, 1097

Wall lighting
A parete
Wandleuchten
Appliques

1092 SCUBO

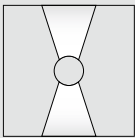
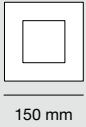

Article code* / Codice articolo* / Artikelnummer* / Code de l'article*
1092-396-3012

Weight / Peso / Gewicht / Poids
2,1 Kg

Materials / Materiali / Materialien / Matériaux
BETALY®

Light source / Sorgente luminosa / Leuchtmittel / Source lumineuse
LED 20W

Tension / Tensione / Spannung / Tension
220-240Vac 50/60Hz
ON/OFF Driver included inside / Driver ON/OFF incluso all'interno
Inklusive ON/OFF Betriebsgerät / Alimentation ON/OFF incluse

Colour temperature / Tonalità / Farbtemperatur / Température de couleur
3000°K

Lumen
800lm

CRI
80

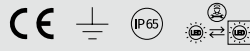

1096B MATT

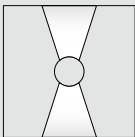
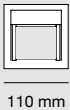
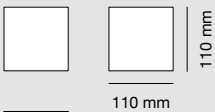

Article code* / Codice articolo* / Artikelnummer* / Code de l'article*
1096B-396-30160

Weight / Peso / Gewicht / Poids
1,6 Kg

Materials / Materiali / Materialien / Matériaux
BETALY®

Light source / Sorgente luminosa / Leuchtmittel / Source lumineuse
LED 6W

Tension / Tensione / Spannung / Tension
24Vdc
Remote constant voltage driver is required / Necessita di alimentatore remoto tensione costante
Benötigt externe Spannungsversorgung / Alimentateur à tension constante déporté nécessaire

Colour temperature / Tonalità / Farbtemperatur / Température de couleur
3000°K

On request available in other color temperatures / Disponibile su richiesta anche con altre temperature colore
Auf Anfrage in anderen Farbtemperaturen erhältlich / Sur demande disponible dans d'autres températures de couleur

Lumen
800lm

CRI
80



1096C MATT X

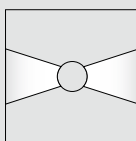
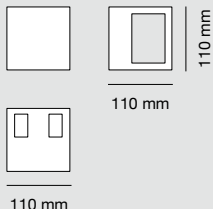

Article code* / Codice articolo* / Artikelnummer* / Code de l'article*
1096C-396-30160

Weight / Peso / Gewicht / Poids
1,6 Kg

Materials / Materiali / Materialien / Matériaux
BETALY®

Light source / Sorgente luminosa / Leuchtmittel / Source lumineuse
LED 6W

Tension / Tensione / Spannung / Tension
24Vdc

Remote constant voltage driver is required / Necessita di alimentatore remoto tensione costante
Benötigt externe Spannungsversorgung / Alimentateur à tension constante déporté nécessaire

Colour temperature / Tonalità / Farbtemperatur / Température de couleur
3000°K

On request available in other color temperatures / Disponibile su richiesta anche con altre temperature colore
Auf Anfrage in anderen Farbtemperaturen erhältlich / Sur demande disponible dans d'autres températures de couleur

Lumen
800lm

CRI
80



1096D MATT Y

NEW

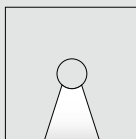
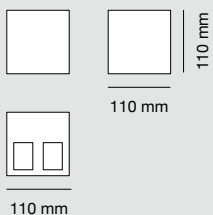

Article code* / Codice articolo* / Artikelnummer* / Code de l'article*
1096D-396-30160

Weight / Peso / Gewicht / Poids
2,0 Kg

Materials / Materiali / Materialien / Matériaux
BETALY®

Light source / Sorgente luminosa / Leuchtmittel / Source lumineuse
LED 6W

Tension / Tensione / Spannung / Tension
24Vdc

Remote constant voltage driver is required / Necessita di alimentatore remoto tensione costante
Benötigt externe Spannungsversorgung / Alimentateur à tension constante déporté nécessaire

Colour temperature / Tonalità / Farbtemperatur / Température de couleur
3000°K

On request available in other color temperatures / Disponibile su richiesta anche con altre temperature colore
Auf Anfrage in anderen Farbtemperaturen erhältlich / Sur demande disponible dans d'autres températures de couleur

Lumen
800lm

CRI
80



1097 MATT BIG

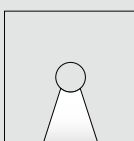

Article code* / Codice articolo* / Artikelnummer* / Code de l'article*
1097-396-30159

Weight / Peso / Gewicht / Poids
3,6 Kg

Materials / Materiali / Materialien / Matériaux
BETALY®

Light source / Sorgente luminosa / Leuchtmittel / Source lumineuse
LED 10W

Tension / Tensione / Spannung / Tension
220-240Vac 50/60Hz
ON/OFF Driver included inside / Driver ON/OFF incluso all'interno
Inklusive ON/OFF Betriebsgerät / Alimentation ON/OFF incluse

Colour temperature / Tonalità / Farbtemperatur / Température de couleur
3000°K

Lumen
800lm

CRI
80

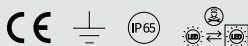

*Colors of the material / Colori del materiale / Farben der Materialien / Couleurs des matériaux



On request available in white dyeable color / Disponibile su richiesta in finitura bianca colorabile
Auf Anfrage in weißer einfärbbarer Farbe erhältlich / Sur demande disponible en couleur blanche teintable

Accessories / Accessori / Zubehöre / Accessoires

Power supply code / Codice alimentatore / Netzgerät Code / Code driver	026.258	026.259	026.301
Power / Potenza / Leistung / Puissance	12W - 24Vdc	36W - 24Vdc	24W - 24Vdc
Protection degree / Grado di protezione / Schutzklasse / Degré de protection	IP20	IP20	IP20
Measurements / Misure / Abmessungen / Dimensions	112 x 45 x 16 mm	169 x 57 x 19 mm	164 x 38 x 25 mm
Dimming / Dimmerazione / Dimmung / Variateur de lumière	ON/OFF	ON/OFF	DIM PUSH / DALI / 0-10V / 1-10V
Input / ingresso / Eingang / Entrée	IN 220-240V~	IN 220-240V~	IN 220-240V~

1095B MEZZARCO

Designed by 9010novantadiecì

EN A wall lamp with a characteristic protruding crescent shape. Its lower and upper parts are slightly hollowed. A bi-emission LED light is contained within, guaranteeing bright and diffused upward and downward luminous definition.

IT Applique dalla caratteristica forma a mezzaluna sporgente. Le parti inferiore e superiore risultano leggermente incavate. Al loro interno è presente la luce a LED a biemissione, che garantisce una netta ed estesa definizione luminosa verso l'alto e il basso.

DE Wandleuchte mit charakteristischer hervortretender Halbmondform. Der Unter- und der Oberteil sind leicht zurück versetzt. Im Inneren befindet sich das zweiflämmige LED-Licht, das eine klare, weite Definition der Helligkeit nach oben und unten gewährleistet.

FR Applique murale avec une forme caractéristique de demi-lune en saillie. Les parties inférieure et supérieure sont légèrement en retrait. À l'intérieur, l'éclairage LED bi-émission assure une définition claire et diffuse de la lumière vers le haut et vers le bas.



Art. 1095B-396-30160



Art. 1095B-396-30160

Art. 1095B-393-30160



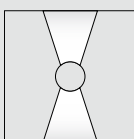
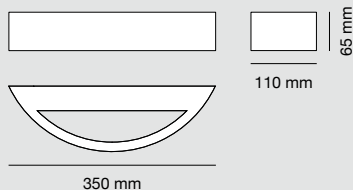

Article code* / Codice articolo* / Artikelnummer* / Code de l'article*
1095B-396-30160

Weight / Peso / Gewicht / Poids
2,0 Kg

Materials / Materiali / Materialien / Matériaux
BETALY®

Light source / Sorgente luminosa / Leuchtmittel / Source lumineuse
LED 6W

Tension / Tensione / Spannung / Tension
24Vdc

Remote constant voltage driver is required / Necessita di alimentatore remoto tensione costante
Benötigt externe Spannungsversorgung / Alimentateur à tension constante déporté nécessaire

Colour temperature / Tonalità / Farbtemperatur / Température de couleur
3000°K

On request available in other color temperatures / Disponibile su richiesta anche con altre temperature colore
Auf Anfrage in anderen Farbtemperaturen erhältlich / Sur demande disponible dans d'autres températures de couleur

Lumen
800lm

CRI
80



*Colors of the material / Colori del materiale / Farben der Materialien / Couleurs des matériaux



On request available in white dyeable color / Disponibile su richiesta in finitura bianca colorabile
Auf Anfrage in weißer einfärbbarer Farbe erhältlich / Sur demande disponible en couleur blanche teintable

Accessories / Accessori / Zubehöre / Accessoires

Power supply code / Codice alimentatore / Netzgerät Code / Code driver	026.258	026.259	026.301
Power / Potenza / Leistung / Puissance	12W - 24Vdc	36W - 24Vdc	24W - 24Vdc
Protection degree / Grado di protezione / Schutzklasse / Degré de protection	IP20	IP20	IP20
Measurements / Misure / Abmessungen / Dimensions	112 x 45 x 16 mm	169 x 57 x 19 mm	164 x 38 x 25 mm
Dimming / Dimmerazione / Dimmung / Variateur de lumière	ON/OFF	ON/OFF	DIM PUSH / DALI / 0-10V / 1-10V
Input / ingresso / Eingang / Entrée	IN 220-240V~	IN 220-240V~	IN 220-240V~

1098 LEVICO WALL

1098B LEVICO WALL S

Designed by HENRY & CO.

EN Like a mountain spring, the light source is isolated and concealed, like the water of a river, the light carves its course through the body of the lamp, leaving behind hollows and dips which soften the diffusion.

IT Come una sorgente d'alta quota, la fonte luminosa è isolata e celata e come l'acqua di un fiume, la luce scava il suo percorso attraverso il corpo luminoso, lasciandosi dietro conche ed avvallamenti che ne ammorbidiscono la diffusione.

DE Wie eine Quelle in den Bergen ist die Lichtquelle isoliert und verborgen und wie das Wasser eines Flusses gräbt sich das Licht seinen Weg durch den Lichtkörper, wobei es Mulden und Vertiefungen hinterlässt, die seine Diffusion weicher machen.

FR Comme une source de haute altitude, la source lumineuse est isolée et masquée, et comme l'eau d'un fleuve, la lumière creuse son parcours à travers le corps lumineux, en s'immiscant derrière conques et profondeurs qui en adoucissent la diffusion.



Wall lighting
A parete
Wandleuchten
Appliques

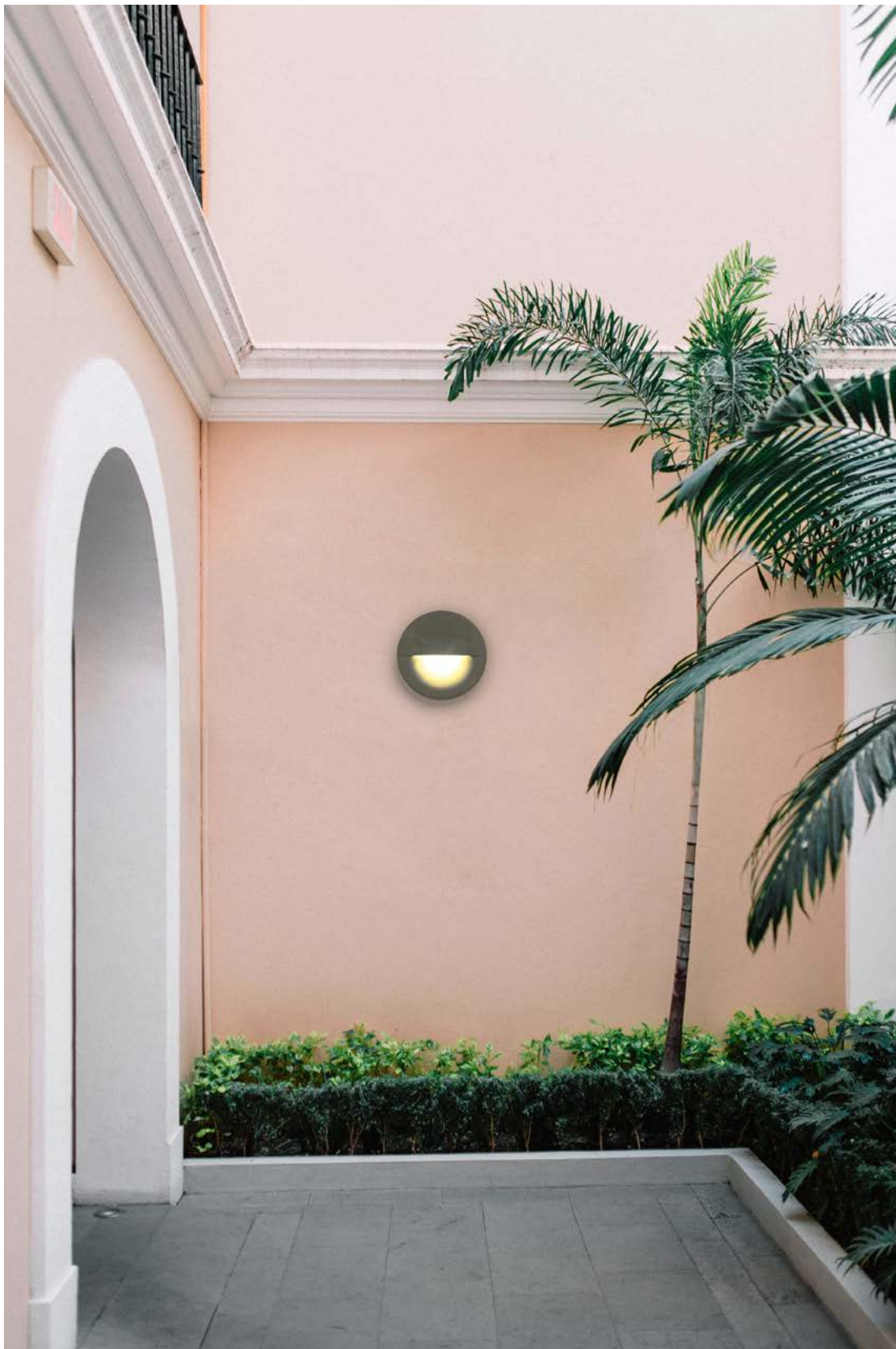

Art. 1098-396-30160



Art. 1098-393-30160



○
Light downwards only
Direzione luce solo verso il basso
Licht nur nach unten
Lumière seulement vers le bas

1098 LEVICO WALL

Designed by HENRY & CO.

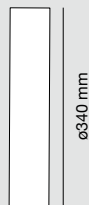
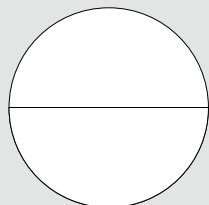

ø340 mm



75 mm

ø340 mm

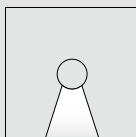

Article code* / Codice articolo* / Artikelnummer* / Code de l'article*
1098-396-30160

Weight / Peso / Gewicht / Poids
5,1 Kg

Materials / Materiali / Materialien / Matériaux
BETALY®

Light source / Sorgente luminosa / Leuchtmittel / Source lumineuse
LED 6W

Tension / Tensione / Spannung / Tension
24Vdc

Remote constant voltage driver is required / Necessita di alimentatore remoto tensione costante
Benötigt externe Spannungsversorgung / Alimentateur à tension constante déporté nécessaire

Colour temperature / Tonalità / Farbtemperatur / Température de couleur
3000°K

On request available in other color temperatures / Disponibile su richiesta anche con altre temperature colore
Auf Anfrage in anderen Farbtemperaturen erhältlich / Sur demande disponible dans d'autres températures de couleur

Lumen
800lm

CRI
80



1098B LEVICO WALL S

Designed by HENRY & CO.

NEW

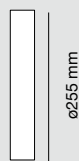
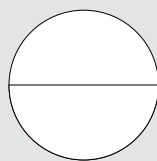

ø255 mm



57 mm

ø255 mm

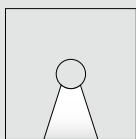

Article code* / Codice articolo* / Artikelnummer* / Code de l'article*
1098B-396-30160

Weight / Peso / Gewicht / Poids
2,8 Kg

Materials / Materiali / Materialien / Matériaux
BETALY®

Light source / Sorgente luminosa / Leuchtmittel / Source lumineuse
LED 6W

Tension / Tensione / Spannung / Tension
24Vdc

Remote constant voltage driver is required / Necessita di alimentatore remoto tensione costante
Benötigt externe Spannungsversorgung / Alimentateur à tension constante déporté nécessaire

Colour temperature / Tonalità / Farbtemperatur / Température de couleur
3000°K

On request available in other color temperatures / Disponibile su richiesta anche con altre temperature colore
Auf Anfrage in anderen Farbtemperaturen erhältlich / Sur demande disponible dans d'autres températures de couleur

Lumen
800lm

CRI
80





On request available in white dyeable color / Disponibile su richiesta in finitura bianca colorabile
 Auf Anfrage in weißer einfärbbarer Farbe erhältlich / Sur demande disponible en couleur blanche teintable

Accessories / Accessori / Zubehör / Accessoires

Power supply code / Codice alimentatore / Netzgerät Code / Code driver	026.258	026.259	026.301
Power / Potenza / Leistung / Puissance	12W - 24Vdc	36W - 24Vdc	24W - 24Vdc
Protection degree / Grado di protezione / Schutzklasse / Degré de protection	IP20	IP20	IP20
Measurements / Misure / Abmessungen / Dimensions	112 x 45 x 16 mm	169 x 57 x 19 mm	164 x 38 x 25 mm
Dimming / Dimmerazione / Dimmung / Variateur de lumière	ON/OFF	ON/OFF	DIM PUSH / DALI / 0-10V / 1-10V
Input / ingresso / Eingang / Entrée	IN 220-240V~	IN 220-240V~	IN 220-240V~

Range Collection / Collezione / Range-Kollektion / Collection Range

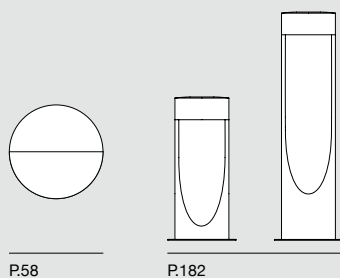

1104 DOMINO

Designed by Alberto Ghirardello

EN DOMINO is made in BETALY® with pure, austere geometric lines, and consists of two distinct elements, which means the lamp can also be produced in a two-colour version.

IT DOMINO è realizzata in BETALY® con delle forme geometriche pure e rigorose ed è composta da due distinti elementi, peculiarità che permette di offrire il prodotto anche in versione bicolore.

DE DOMINO ist aus BETALY® mit reinen und strengen geometrischen Formen gefertigt und besteht aus zwei unterschiedlichen Elementen, eine Besonderheit, die es ermöglicht, das Produkt auch in zweifarbiger Version anzubieten.

FR DOMINO est en BETALY® avec des formes géométriques pures et rigoureuses, et se compose de deux éléments séparés, une particularité qui permet de proposer le produit aussi en version bicolore.



Art. 1104A-392-3012



Art. 1104A-396-3012 + 1104Q-396



○
Tempered etched glass
Vetro temperato acidato
Geätztes gehärtetes Glas
Verre trempé satiné

Art. 1104A-393-3012 + 1104Q-396



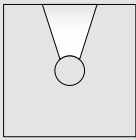
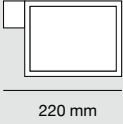

Article code* / Codice articolo* / Artikelnummer* / Code de l'article*
1104A-396-3012 + 1104Q-396

Weight / Peso / Gewicht / Poids
2,6 Kg

Materials / Materiali / Materialien / Matériaux
BETALY®

Light source / Sorgente luminosa / Leuchtmittel / Source lumineuse
LED 10W

Tension / Tensione / Spannung / Tension
220-240Vac 50/60Hz
ON/OFF Driver included inside / Driver ON/OFF incluso all'interno
Inklusive ON/OFF Betriebsgerät / Alimentation ON/OFF incluse

Colour temperature / Tonalità / Farbtemperatur / Température de couleur
3000°K

Lumen
800lm

CRI
80

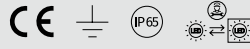

*Colors of the material / Colori del materiale / Farben der Materialien / Couleurs des matériaux



**Modular in two colours / Componibile in due colorazioni / Modularesystem auf zwei Farben / Modulable en deux couleurs

On request available in white dyeable color / Disponibile su richiesta in finitura bianca colorabile
Auf Anfrage in weißer einfärbbarer Farbe erhältlich / Sur demande disponible en couleur blanche teintable

Example / Esempio / Beispiel / Exemple

Art. 1104A-395-3012		395
Art. 1104Q-394		394

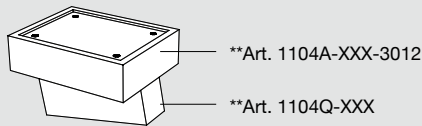

1202A DEFINE

Designed by 9010novantadiecì

EN At night, DEFINE resembles a clip holding together the edges of the wall. Its light can be either bi-emission or mono-emission, emitting a wide and diffused spectrum of light.

IT Di notte DEFINE sembra una clip che tiene insieme i lembi della parete. La sua luce può essere a biemissione o monoemissione, emana un ampio spettro luminoso e diffuso.

DE Nachts scheint DEFINE eine Klammer, die die Enden der Wand zusammenhält. Ihr Licht kann ein- oder zweiflammig sein und erzeugt ein breites, diffuses Lichtspektrum.

FR La nuit, DEFINE ressemble à un clip qui maintient les bords du mur ensemble. Sa lumière peut être à bi-émission ou mono-émission, en émettant un spectre de lumière large et diffus.



Art. 1202A-395-30176



Art.
1202A

Wall lighting
A parete
Wandleuchten
Appliques

9010novantadiecì Outdoor

70



Art. 1202A-395-30175

Art. 1202A-395-30176



○
Bi-emission (up and down)
Biemissione (sopra e sotto)
Zweiflämmig (oben und unten)
Bi-émission (vers le haut et vers le bas)

Art. 1202A-395-30175



○
Mono-emission (up or down)
Monoemissione (sopra o sotto)
Einflämmig (oben oder unten)
Mono-émission (vers le haut ou vers le bas)

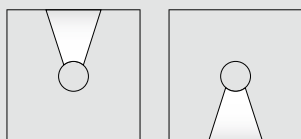
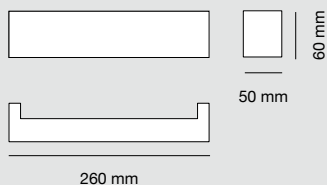

Article code* / Codice articolo* / Artikelnummer* / Code de l'article*
1202A-396-30175

Weight / Peso / Gewicht / Poids
1,0 Kg

Materials / Materiali / Materialien / Matériaux
BETALY®

Light source / Sorgente luminosa / Leuchtmittel / Source lumineuse
LED 12W

Tension / Tensione / Spannung / Tension
24Vdc

Remote constant voltage driver is required / Necessita di alimentatore remoto tensione costante
Benötigt externe Spannungsversorgung / Alimentateur à tension constante déporté nécessaire

Colour temperature / Tonalità / Farbtemperatur / Température de couleur
3000°K

On request available in other color temperatures / Disponibile su richiesta anche con altre temperature colore
Auf Anfrage in anderen Farbtemperaturen erhältlich / Sur demande disponible dans d'autres températures de couleur

Lumen
1600lm

CRI
80

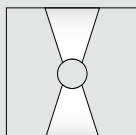
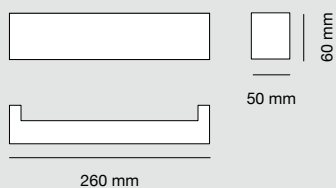

Article code* / Codice articolo* / Artikelnummer* / Code de l'article*
1202A-396-30176

Weight / Peso / Gewicht / Poids
1,0 Kg

Materials / Materiali / Materialien / Matériaux
BETALY®

Light source / Sorgente luminosa / Leuchtmittel / Source lumineuse
LED 24W

Tension / Tensione / Spannung / Tension
24Vdc

Remote constant voltage driver is required / Necessita di alimentatore remoto tensione costante
Benötigt externe Spannungsversorgung / Alimentateur à tension constante déporté nécessaire

Colour temperature / Tonalità / Farbtemperatur / Température de couleur
3000°K

On request available in other color temperatures / Disponibile su richiesta anche con altre temperature colore
Auf Anfrage in anderen Farbtemperaturen erhältlich / Sur demande disponible dans d'autres températures de couleur

Lumen
3200lm

CRI
80





On request available in white dyeable color / Disponibile su richiesta in finitura bianca colorabile
 Auf Anfrage in weißer einfärbbarer Farbe erhältlich / Sur demande disponible en couleur blanche teintable

Accessories / Accessori / Zubehöre / Accessoires

Power supply code / Codice alimentatore / Netzgerät Code / Code driver	026.259	026.260	026.301
Power / Potenza / Leistung / Puissance	36W - 24Vdc	60W - 24Vdc	24W - 24Vdc
Protection degree / Grado di protezione / Schutzklasse / Degré de protection	IP20	IP20	IP20
Measurements / Misure / Abmessungen / Dimensions	169 x 57 x 19 mm	169 x 57 x 19 mm	164 x 38 x 25 mm
Dimming / Dimmerazione / Dimmung / Variateur de lumière	ON/OFF	ON/OFF	DIM PUSH / DALI / 0-10V / 1-10V
Input / ingresso / Eingang / Entrée	IN 220-240V~	IN 220-240V~	IN 220-240V~

Power supply code / Codice alimentatore / Netzgerät Code / Code driver	026.209	026.190
Power / Potenza / Leistung / Puissance	60W - 24Vdc	Max 288W - 24Vdc
Protection degree / Grado di protezione / Schutzklasse / Degré de protection	IP20	IP20
Measurements / Misure / Abmessungen / Dimensions	127 x 82 x 30 mm	164 x 38 x 25 mm
Dimming / Dimmerazione / Dimmung / Variateur de lumière	DIM PUSH/1-10V	DIMMER DALI/PUSH/0-10V/1-10V
Input / ingresso / Eingang / Entrée	IN 220-240V~	IN 12-48Vdc

1205 KERIS

Designed by Alice Barki

EN A dry beam of light propagates and cuts through space like a blade. KERIS is a dome wall lamp characterized by two wide and clear lateral slits. Similar to what happens in a reflective prism, the projected light source is diffused in reciprocal directions, creating an evocative atmosphere.

IT Un fascio secco di luce si propaga e taglia lo spazio come una lama. KERIS è un'appliche a cupola contraddistinta da due nette e ampie fessure laterali. Simile a quanto accade in un prisma rifrangente, la fonte luminosa proiettata si orienta nelle reciproche direzioni creando un'atmosfera suggestiva.

DE Ein trockener Lichtstrahl breitet sich aus und durchtrennt den Raum wie eine Messerklinge. KERIS ist eine kuppelförmige Wandleuchte mit dem Kennzeichen von zwei klaren, breiten seitlichen Schlitzten. Ähnlich wie in einem optischen Prisma richtet sich die projizierende Lichtquelle in entgegengesetzten Richtungen aus und erzeugt eine anregende Atmosphäre.

FR Un faisceau de lumière ne se répand et coupe l'espace comme une lame. KERIS est une applique murale en forme de coupole se distinguant par deux larges fentes sur les côtés. Tel un prisme réfracteur, la source lumineuse projetée pivote dans des directions réciproques, en créant une atmosphère saisissante.

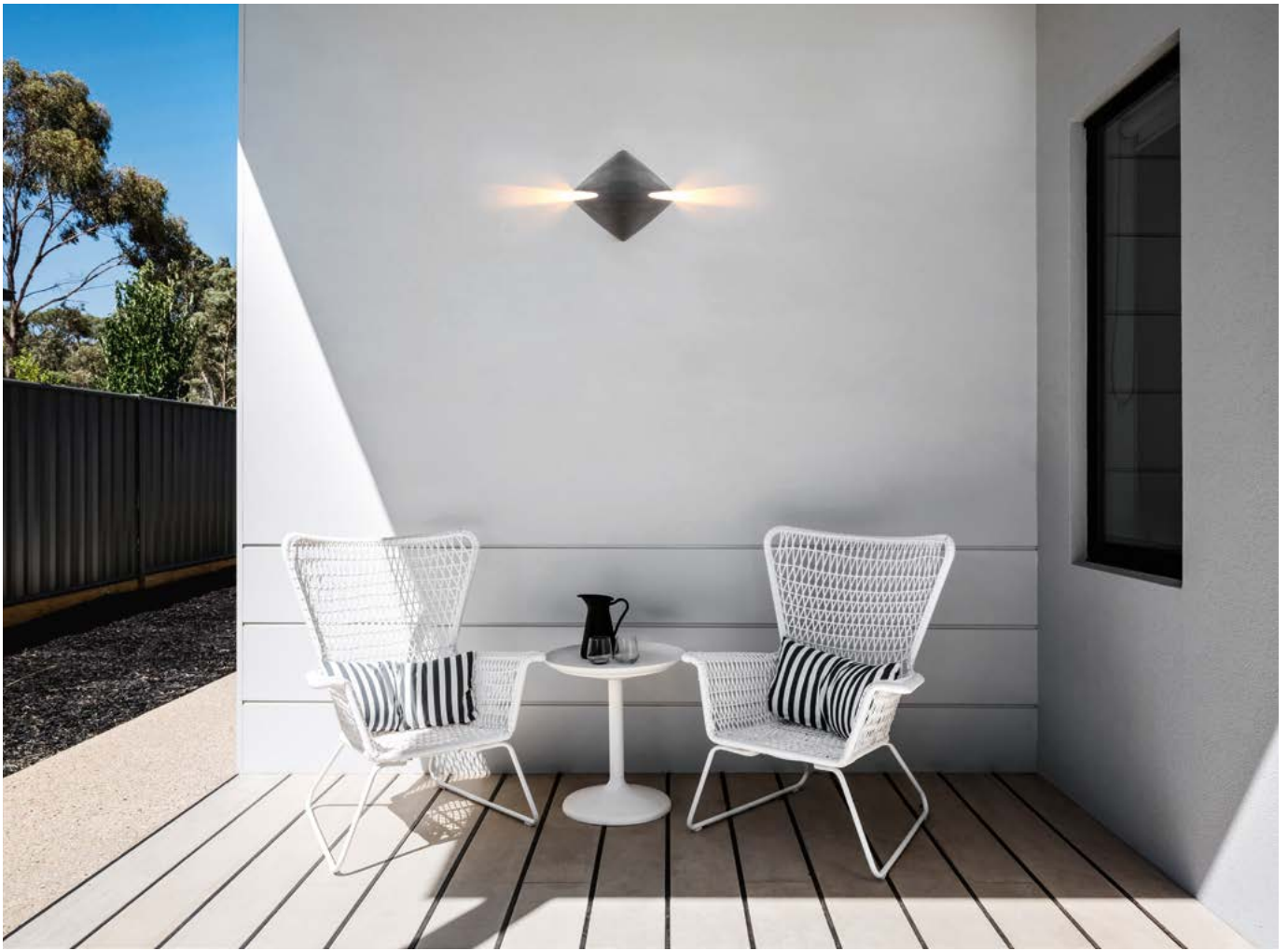

Art. 1205-396-30174

Art. 1205-395-30174





Art. 1205-393-30174





Article code* / Codice articolo* / Artikelnummer* / Code de l'article*
1205-396-30174

Weight / Peso / Gewicht / Poids
1,6 Kg

Materials / Materiali / Materialien / Matériaux
BETALY®

Light source / Sorgente luminosa / Leuchtmittel / Source lumineuse
LED 12W

Tension / Tensione / Spannung / Tension
24Vdc

Remote constant voltage driver is required / Necessita di alimentatore remoto tensione costante
Benötigt externe Spannungsversorgung / Alimentateur à tension constante déporté nécessaire

Colour temperature / Tonalità / Farbtemperatur / Température de couleur
3000°K

On request available in other color temperatures / Disponibile su richiesta anche con altre temperature colore
Auf Anfrage in anderen Farbtemperaturen erhältlich / Sur demande disponible dans d'autres températures de couleur

Lumen
1600lm

CRI
80

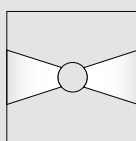
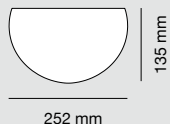
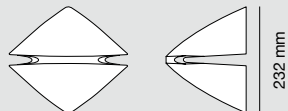

*Colors of the material / Colori del materiale / Farben der Materialien / Couleurs des matériaux



On request available in white dyeable color / Disponibile su richiesta in finitura bianca colorabile
Auf Anfrage in weißer einfärbbarer Farbe erhältlich / Sur demande disponible en couleur blanche teintable

Accessories / Accessori / Zubehöre / Accessoires

Power supply code / Codice alimentatore / Netzgerät Code / Code driver	026.259	026.260	026.301
Power / Potenza / Leistung / Puissance	36W - 24Vdc	60W - 24Vdc	24W - 24Vdc
Protection degree / Grado di protezione / Schutzklasse / Degré de protection	IP20	IP20	IP20
Measurements / Misure / Abmessungen / Dimensions	169 x 57 x 19 mm	169 x 57 x 19 mm	164 x 38 x 25 mm
Dimming / Dimmerazione / Dimmung / Variateur de lumière	ON/OFF	ON/OFF	DIM PUSH / DALI / 0-10V / 1-10V
Input / ingresso / Eingang / Entrée	IN 220-240V~	IN 220-240V~	IN 220-240V~

1206 ARCIERE

Designed by 9010novantadiecì

EN A sinuous arc defines the structure of this wall lamp. The light source is never revealed; it is kept hidden by the light's large front portion, spreading upwards and downwards along the soft curves of the lamp.

IT Un arco sinuoso definisce la struttura di questa lampada a parete. La sorgente luminosa non viene mai rivelata, resta nascosta dall'ampia porzione frontale, per diffondersi verso l'alto e il basso percorrendo le morbide curve della lampada.

DE Die Struktur dieser Wandleuchte wird durch einen geschwungenen Bogen definiert. Die Lichtquelle wird nie gezeigt, sie bleibt hinter der breiten vorderen Portion verdeckt und das Licht verbreitet sich entlang der geschmeidigen Kurven der Lampe nach oben und unten.

FR Un arc sinueux définit la structure de cette applique. La source lumineuse n'est jamais révélée, elle reste cachée par la grande partie frontale, pour se diffuser vers le haut et vers le bas le long des courbes douces de la lampe.



Art. 1206-395-30160



Art. 1206-396-30160



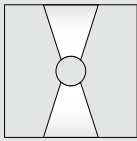
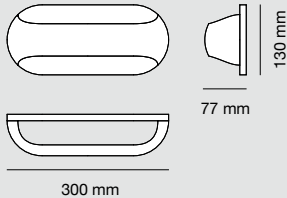

Article code* / Codice articolo* / Artikelnummer* / Code de l'article*
1206-396-30160

Weight / Peso / Gewicht / Poids
1,0 Kg

Materials / Materiali / Materialien / Matériaux
BETALY®

Light source / Sorgente luminosa / Leuchtmittel / Source lumineuse
LED 6W

Tension / Tensione / Spannung / Tension
24Vdc

Remote constant voltage driver is required / Necessita di alimentatore remoto tensione costante
Benötigt externe Spannungsversorgung / Alimentateur à tension constante déporté nécessaire

Colour temperature / Tonalità / Farbtemperatur / Température de couleur
3000°K

On request available in other color temperatures / Disponibile su richiesta anche con altre temperature colore
Auf Anfrage in anderen Farbtemperaturen erhältlich / Sur demande disponible dans d'autres températures de couleur

Lumen
800lm

CRI
80



*Colors of the material / Colori del materiale / Farben der Materialien / Couleurs des matériaux



On request available in white dyeable color / Disponibile su richiesta in finitura bianca colorabile
Auf Anfrage in weißer einfärbbarer Farbe erhältlich / Sur demande disponible en couleur blanche teintable

Accessories / Accessori / Zubehöre / Accessoires

Power supply code / Codice alimentatore / Netzgerät Code / Code driver	026.259	026.260	026.301
Power / Potenza / Leistung / Puissance	36W - 24Vdc	60W - 24Vdc	24W - 24Vdc
Protection degree / Grado di protezione / Schutzklasse / Degré de protection	IP20	IP20	IP20
Measurements / Misure / Abmessungen / Dimensions	169 x 57 x 19 mm	169 x 57 x 19 mm	164 x 38 x 25 mm
Dimming / Dimmerazione / Dimmung / Variateur de lumière	ON/OFF	ON/OFF	DIM PUSH / DALI / 0-10V / 1-10V
Input / ingresso / Eingang / Entrée	IN 220-240V~	IN 220-240V~	IN 220-240V~

CEILING LIGHTING
A PLAFONE
DECKENLEUCHTEN
PLAFONNIERS



1094 SCUBO C

1094B SCUBO C SMALL

1094C SCUBO C FLAT

Designed by 9010novantadiecì

EN A discreet ceiling light with direct downward illumination, also available in a wall-mounted version. A cube that protrudes from the wall emitting a soft, focussed light. Its compactness allows the supports to be closely positioned along external patios or corridors.

IT Una plafoniera discreta con luce diretta verso il basso, disponibile anche a parete. Il cubo sporge rispetto al soffitto ed emana una gentile luce orientata. Le dimensioni ridotte permettono di allineare i supporti a distanza ravvicinata lungo patii o corridoi esterni.

DE Eine diskrete Deckenleuchte mit direktem Licht nach unten, die auch als Wandleuchte erhältlich ist. Der Würfel ragt aus der Decke heraus und strahlt ein mildes gerichtetes Licht aus. Die geringen Maße ermöglichen die Ausrichtung der Halter in geringer Entfernung entlang von Patios oder Außenkorridoren.

FR Un plafonnier discret avec une lumière dirigée vers le bas, également disponible aussi en applique murale. Le cube dépasse du plafond et émet une lumière douce orientée. Les petites dimensions permettent d'aligner les supports à faible distance le long des patios ou des couloirs extérieurs.



Art. 1094C-392-3012



Art. 1094-396-3012



Art. 1094-396-3012



1094 SCUBO C

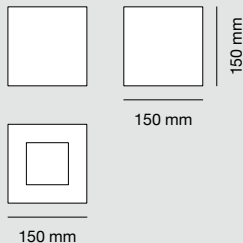

Article code* / Codice articolo* / Artikelnummer* / Code de l'article*
1094-396-3012

Weight / Peso / Gewicht / Poids
1,5 Kg

Materials / Materiali / Materialien / Matériaux
BETALY®

Light source / Sorgente luminosa / Leuchtmittel / Source lumineuse
LED 10W

Tension / Tensione / Spannung / Tension
220-240Vac 50/60Hz

ON/OFF Driver included inside / Driver ON/OFF incluso all'interno
Inklusive ON/OFF Betriebsgerät / Alimentation ON/OFF incluse

Colour temperature / Tonalità / Farbtemperatur / Température de couleur
3000°K

Lumen
800lm

CRI
80

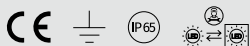

1094B SCUBO C SMALL

NEW

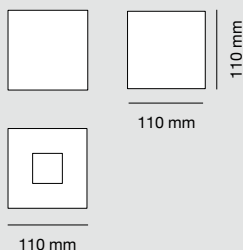

Article code* / Codice articolo* / Artikelnummer* / Code de l'article*
1094B-396-30160

Weight / Peso / Gewicht / Poids
1,4 Kg

Materials / Materiali / Materialien / Matériaux
BETALY®

Light source / Sorgente luminosa / Leuchtmittel / Source lumineuse
LED 6W

Tension / Tensione / Spannung / Tension
24Vdc

Remote constant voltage driver is required / Necessita di alimentatore remoto tensione costante
Benötigt externe Spannungsversorgung / Alimentateur à tension constante déporté nécessaire

Colour temperature / Tonalità / Farbtemperatur / Température de couleur
3000°K

Lumen
800lm

CRI
80



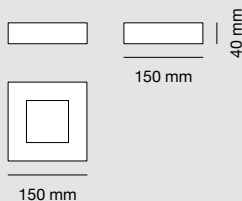

Article code* / Codice articolo* / Artikelnummer* / Code de l'article*
1094C-396-3012

Weight / Peso / Gewicht / Poids
1,0 Kg

Materials / Materiali / Materialien / Matériaux
BETALY®

Light source / Sorgente luminosa / Leuchtmittel / Source lumineuse
LED 10W

Tension / Tensione / Spannung / Tension
220-240Vac 50/60Hz
ON/OFF Driver included inside / Driver ON/OFF incluso all'interno
Inklusive ON/OFF Betriebsgerät / Alimentation ON/OFF incluse

Colour temperature / Tonalità / Farbtemperatur / Température de couleur
3000°K
On request available in other color temperatures / Disponibile su richiesta anche con altre temperature colore
Auf Anfrage in anderen Farbtemperaturen erhältlich / Sur demande disponible dans d'autres températures de couleur

Lumen
800lm

CRI
80

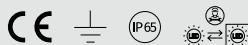

*Colors of the material / Colori del materiale / Farben der Materialien / Couleurs des matériaux



On request available in white dyeable color / Disponibile su richiesta in finitura bianca colorabile
Auf Anfrage in weißer einfärbbarer Farbe erhältlich / Sur demande disponible en couleur blanche teintable

Accessories / Accessori / Zubehöre / Accessoires

Power supply code / Codice alimentatore / Netzgerät Code / Code driver	026.258	026.259	026.301
Power / Potenza / Leistung / Puissance	12W - 24Vdc	36W - 24Vdc	24W - 24Vdc
Protection degree / Grado di protezione / Schutzklasse / Degré de protection	IP20	IP20	IP20
Measurements / Misure / Abmessungen / Dimensions	112 x 45 x 16 mm	169 x 57 x 19 mm	164 x 38 x 25 mm
Dimming / Dimmerazione / Dimmung / Variateur de lumière	ON/OFF	ON/OFF	DIM PUSH / DALI / 0-10V / 1-10V
Input / ingresso / Eingang / Entrée	IN 220-240V~	IN 220-240V~	IN 220-240V~

1203 SILOS

Designed by 9010novantadiecì

EN Its minimal design makes it a suitable element for lighting covered terraces or canopies. SILOS lends spaces a sense of rigour. Its tubular shape emits a beam of direct light that is at the same time pleasantly enveloping.

IT Il design minimale lo rende un elemento adatto ad illuminare terrazze coperte o tettoie. SILOS conferisce un senso di rigore allo spazio. La sua forma tubolare emette un fascio di luce diretta e allo stesso tempo piacevolmente avvolgente.

DE Dank des minimalistischen Designs ist dieses Element für die Beleuchtung von überdachten Terrassen oder Überdachungen geeignet. SILOS verleiht dem Raum ein Gefühl der Strenge. Seine Röhrenform gibt einen direkten und gleichzeitig angenehm einhüllenden Lichtstrahl ab.

FR Élément adapté à l'éclairage des terrasses couvertes ou des marquises grâce à son design minimaliste. SILOS confère un sentiment de rigueur à l'espace. Sa forme tubulaire émet un faisceau de lumière direct mais agréablement enveloppant.



Art. 1203-396-30160



Art. 1203-396-30160

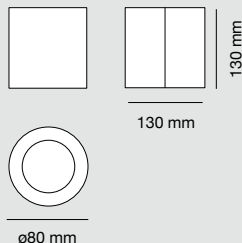

Article code* / Codice articolo* / Artikelnummer* / Code de l'article*
1203-396-30160

Weight / Peso / Gewicht / Poids
1,7 Kg

Materials / Materiali / Materialien / Matériaux
BETALY®

Light source / Sorgente luminosa / Leuchtmittel / Source lumineuse
LED 6W

Tension / Tensione / Spannung / Tension
24Vdc

Remote constant voltage driver is required / Necessita di alimentatore remoto tensione costante
Benötigt externe Spannungsversorgung / Alimentateur à tension constante déporté nécessaire

Colour temperature / Tonalità / Farbtemperatur / Température de couleur
3000°K

On request available in other color temperatures / Disponibile su richiesta anche con altre temperature colore
Auf Anfrage in anderen Farbtemperaturen erhältlich / Sur demande disponible dans d'autres températures de couleur

Lumen
800lm

CRI
80



*Colors of the material / Colori del materiale / Farben der Materialien / Couleurs des matériaux



On request available in white dyeable color / Disponibile su richiesta in finitura bianca colorabile
Auf Anfrage in weißer einfärbbarer Farbe erhältlich / Sur demande disponible en couleur blanche teintable

Accessories / Accessori / Zubehöre / Accessoires

Power supply code / Codice alimentatore / Netzgerät Code / Code driver	026.258	026.259	026.301
Power / Potenza / Leistung / Puissance	12W - 24Vdc	36W - 24Vdc	24W - 24Vdc
Protection degree / Grado di protezione / Schutzklasse / Degré de protection	IP20	IP20	IP20
Measurements / Misure / Abmessungen / Dimensions	112 x 45 x 16 mm	169 x 57 x 19 mm	164 x 38 x 25 mm
Dimming / Dimmerazione / Dimmung / Variateur de lumière	ON/OFF	ON/OFF	DIM PUSH / DALI / 0-10V / 1-10V
Input / ingresso / Eingang / Entrée	IN 220-240V~	IN 220-240V~	IN 220-240V~

PATHMARKERS
SEGNAPASSI
ORIENTIERUNGSBELEUCHTUNG
BALISAGES



1102 SER

Designed by Paolo D'Arrigo

EN "*Biomimicry is innovation inspired by nature*".
Janine M. Benyus

SER is an archetypal product, a hybrid that combines the principles of technology and nature. A product that's flexible and dynamic in use with a minimalist, mimetic aesthetic.

IT "*La biomimesi è innovazione ispirata dalla natura*". *Janine M. Benyus*
SER è un prodotto archetipico, un ibrido che coniuga i principi di tecnologia e natura. Un prodotto flessibile e dinamico nell'uso, dotato di un'estetica essenziale e mimetica.

DE "*Die Biomimetik ist eine von der Natur inspirierte Innovation*". *Janine M. Benyus*
SER ist ein archetypisches Produkt, ein Hybrid, der die Prinzipien von Technologie und Natur kombiniert. Ein beim Gebrauch flexibles und dynamisches Produkt mit essentieller und mimetischer Ästhetik.

FR "*Le biomimétisme est l'innovation inspirée de la nature*". *Janine M. Benyus*
SER est un produit archétypique, un hybride qui associe les principes de technologie et de la nature. Un produit d'utilisation flexible et dynamique, avec une esthétique essentielle et mimétique.



Pathmarkers
Segnapassi
Orientierungsbeleuchtung
Balisages



Art. 1102-394-3012, 1102-395-3012, 1102-396-3012

Art. 1102-395-3012





Art. 1102-392-3012

Pathmarkers
Segnapassi
Orientierungsbeleuchtung
Balisages



○
Tempered etched glass
Vetro temperato acidato
Geätztes gehärtetes Glas
Verre trempé

Back Cover
Coperchio di chiusura
Rückabdeckung
Couverture

Cable exit hole
Foro uscita cavo
Kabelausgang
Sortie du câble

Art. 1102-396-3012



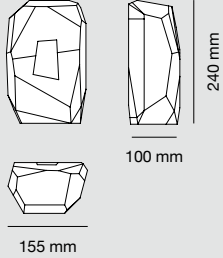

Article code* / Codice articolo* / Artikelnummer* / Code de l'article*
1102-396-3012

Weight / Peso / Gewicht / Poids
3,5 Kg

Materials / Materiali / Materialien / Matériaux
BETALY®

Light source / Sorgente luminosa / Leuchtmittel / Source lumineuse
LED 10W

Tension / Tensione / Spannung / Tension
220-240Vac 50/60Hz
ON/OFF Driver included inside / Driver ON/OFF incluso all'interno
Inklusive ON/OFF Betriebsgerät / Alimentation ON/OFF incluse

Colour temperature / Tonalità / Farbtemperatur / Température de couleur
3000°K

Lumen
800lm

CRI
80

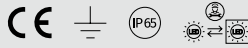

Possible positions / Possibili posizioni / Mögliche Positionen / Positions possibles



*Colors of the material / Colori del materiale / Farben der Materialien / Couleurs des matériaux



On request available in white dyeable color / Disponibile su richiesta in finitura bianca colorabile
Auf Anfrage in weißer einfärbbarer Farbe erhältlich / Sur demande disponible en couleur blanche teintable

1105A BEAN SMALL

Designed by Alberto Ghirardello

EN The shape of BEAN was obtained through subtraction: the completely rounded top, ideal for shedding rainwater, becomes the template for symmetrical cut-outs which house the light sources.

IT La forma di BEAN è stata ottenuta per sottrazione: una sommità a tutto tondo, funzionale alla defluizione dell'acqua piovana, diventa forma generatrice per l'intaglio simmetrico dentro la quale trova posto la sorgente luminosa.

DE Die Form von BEAN wurde durch Subtraktion erhalten: ein runde Oberseite, die den Abfluss des Regenwassers ermöglicht, wird zum Ausgangspunkt für den symmetrischen Schnitt, in dem sich die Lichtquelle befindet.

FR La forme de BEAN a été obtenue par soustraction: un sommet en ronde-bosse, laissant l'eau de pluie s'écouler, devient une forme génératrice avec l'entaille symétrique dans laquelle est positionnée la source lumineuse.



Art. 1105A-394-3012

Art. 1105A-396-3012



Art.
1105A

Pathmarkers
Segnapassi
Orientierungsbeleuchtung
Balisages



Art. 1105C-396-3012, 1105B-396-3012, 1105A-396-3012

○
 Tempered etched glass
 Vetro temperato acidato
 Geätztes gehärtetes Glas
 Verre trempé

Wiring compartment cover
 Coperchio per vano cablaggio
 Kabelanschlussraum Socket
 Couvercle du compartiment
 électrique

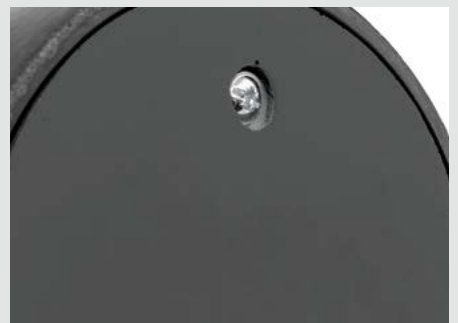



Article code* / Codice articolo* / Artikelnummer* / Code de l'article*
1105A-396-3012

Weight / Peso / Gewicht / Poids
7 Kg

Materials / Materiali / Materialien / Matériaux
BETALY®

Light source / Sorgente luminosa / Leuchtmittel / Source lumineuse
LED 10W

Tension / Tensione / Spannung / Tension
220-240Vac 50/60Hz

ON/OFF Driver included inside / Driver ON/OFF incluso all'interno
Inklusive ON/OFF Betriebsgerät / Alimentation ON/OFF incluse

Colour temperature / Tonalità / Farbtemperatur / Température de couleur
3000°K

Lumen
800lm

CRI
80

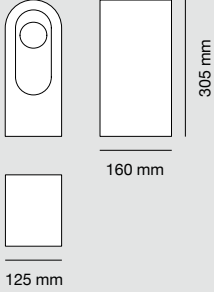
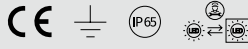

*Colors of the material / Colori del materiale / Farben der Materialien / Couleurs des matériaux



On request available in white dyeable color / Disponibile su richiesta in finitura bianca colorabile
Auf Anfrage in weißer einfärbbarer Farbe erhältlich / Sur demande disponible en couleur blanche teintable

Range Collection / Collezione / Range-Kollektion / Collection Range

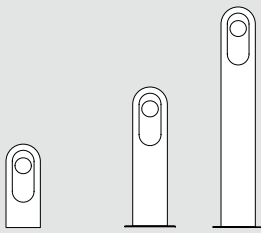

P.102

P.152

1114A TOOTH SMALL

1114B TOOTH

Designed by Maurizio Quargnale

EN Like an incisor, TOOTH sinks its body directly into the ground. Capable of adapting itself to various uses, this practical lighting system represents a new way of illuminating outdoor areas. A useful tool for designers looking for a practical solution to all those situations in which a discreet light, that does not draw too much attention to the light body, is needed to illuminate paths or light areas.

IT Come un incisivo TOOTH affonda direttamente il suo corpo nel terreno. Questo pratico sistema di illuminazione determina un nuovo modo di illuminare gli ambienti esterni, che si adatta alle circostanze di utilizzo. Uno strumento per il progettista che vuole risolvere efficacemente tutte quelle situazioni dove serve una luce discreta per illuminare percorsi o per evidenziare delle aree senza troppo mostrare il corpo illuminante.

DE Wie ein Schneidezahn versenkt TOOTH seinen Körper direkt in der Erde. Dieses praktische Beleuchtungssystem erfindet eine neue Art der Beleuchtung der Außenbereiche, die sich an die jeweilige Einsatzsituation anpasst. Ein Instrument für den Planer, der eine effiziente Lösung in Situationen finden möchte, in denen eine diskrete Beleuchtung der Wege oder die Betonung der Bereiche notwendig ist, ohne den Leuchtkörper zu sehr zu zeigen.

FR Comme une TOOTH incisive qui enfonce son corps directement dans le sol. Ce système d'éclairage pratique détermine une nouvelle façon d'éclairer les espaces extérieurs, et s'adapte aux circonstances d'utilisation. C'est un outil pour le concepteur qui veut résoudre efficacement toutes les situations où une lumière discrète est nécessaire pour éclairer des parcours ou mettre en valeur des zones sans trop montrer le luminaire.

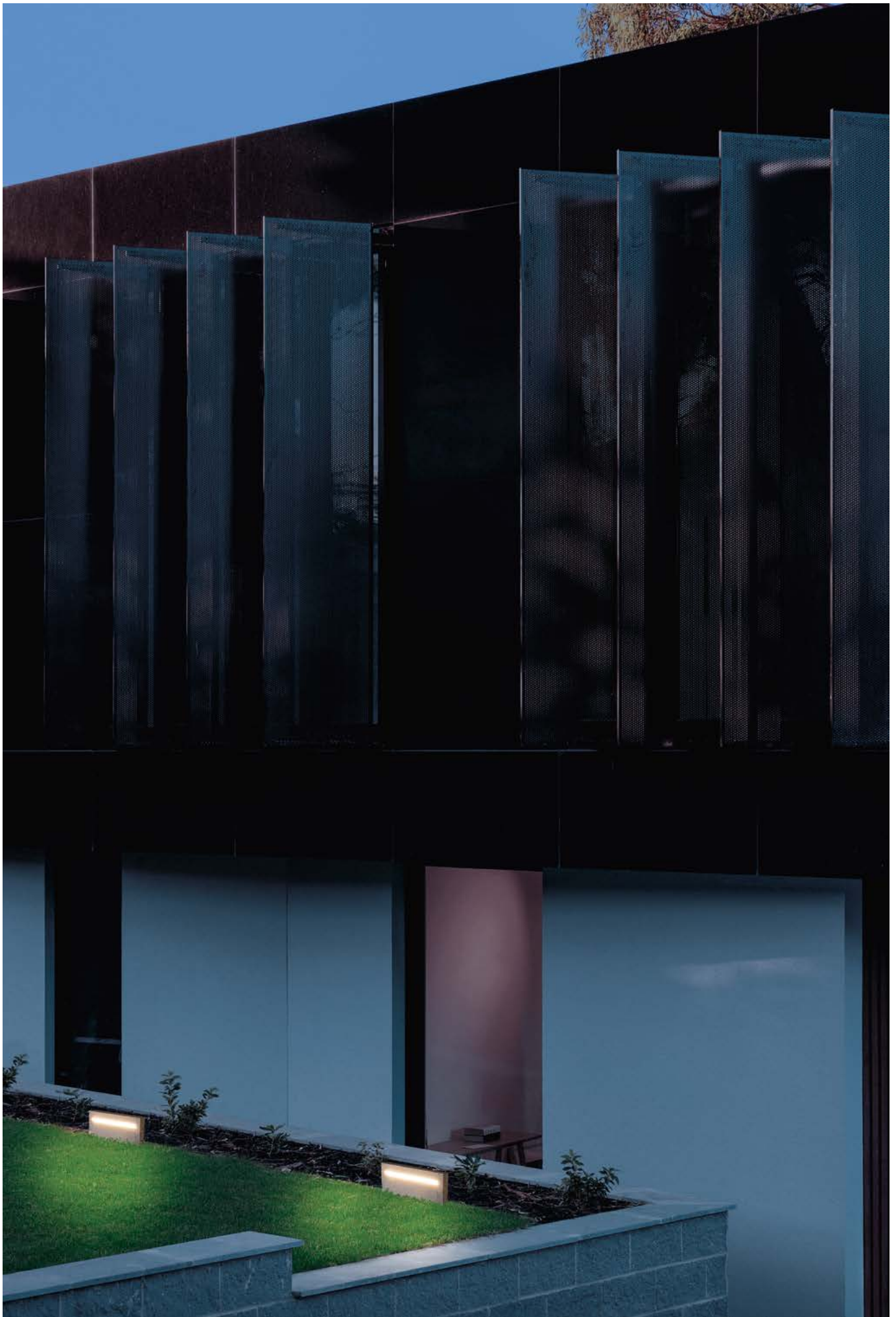

Pathmarkers
Segnapassi
Orientierungsbeleuchtung
Balisages



Art. 1114A-395-30178



It is installed by inserting it into the ground
Installazione tramite inserimento nel terreno
Installation durch Einsetzen in das Erdreich
Installation par enfouissement dans le sol

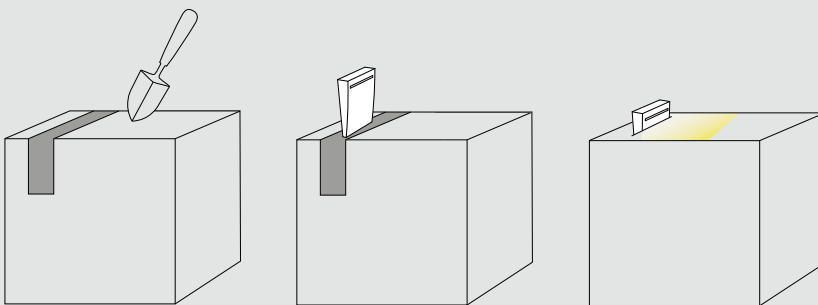



Art. 1114B-395-30178

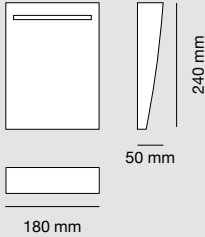

Article code* / Codice articolo* / Artikelnummer* / Code de l'article*
1114A-396-30178

Weight / Peso / Gewicht / Poids
3,4 Kg

Materials / Materiali / Materialien / Matériaux
BETALY®

Light source / Sorgente luminosa / Leuchtmittel / Source lumineuse
LED 1,5W

Tension / Tensione / Spannung / Tension
24Vdc

Remote constant voltage driver is required / Necessita di alimentatore remoto tensione costante
Benötigt externe Spannungsversorgung / Alimentateur à tension constante déporté nécessaire

Colour temperature / Tonalità / Farbtemperatur / Température de couleur
3000°K

On request available in other color temperatures / Disponibile su richiesta anche con altre temperature colore
Auf Anfrage in anderen Farbtemperaturen erhältlich / Sur demande disponible dans d'autres températures de couleur

Lumen
160lm

CRI
80



1114B TOOTH

Designed by Maurizio Quargnale

NEW

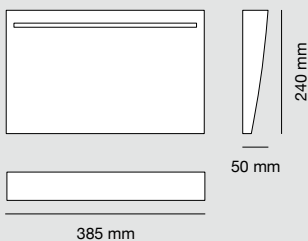

Article code* / Codice articolo* / Artikelnummer* / Code de l'article*
1114B-396-30178

Weight / Peso / Gewicht / Poids
6,5 Kg

Materials / Materiali / Materialien / Matériaux
BETALY®

Light source / Sorgente luminosa / Leuchtmittel / Source lumineuse
LED 3,5W

Tension / Tensione / Spannung / Tension
24Vdc

Remote constant voltage driver is required / Necessita di alimentatore remoto tensione costante
Benötigt externe Spannungsversorgung / Alimentateur à tension constante déporté nécessaire

Colour temperature / Tonalità / Farbtemperatur / Température de couleur
3000°K

On request available in other color temperatures / Disponibile su richiesta anche con altre temperature colore
Auf Anfrage in anderen Farbtemperaturen erhältlich / Sur demande disponible dans d'autres températures de couleur

Lumen
380lm

CRI
80





On request available in white dyeable color / Disponibile su richiesta in finitura bianca colorabile
 Auf Anfrage in weißer einfärbbarer Farbe erhältlich / Sur demande disponible en couleur blanche teintable

Accessories / Accessori / Zubehöre / Accessoires

Power supply code / Codice alimentatore / Netzgerät Code / Code driver	026.258	026.259	026.301
Power / Potenza / Leistung / Puissance	12W - 24Vdc	36W - 24Vdc	24W - 24Vdc
Protection degree / Grado di protezione / Schutzklasse / Degré de protection	IP20	IP20	IP20
Measurements / Misure / Abmessungen / Dimensions	112 x 45 x 16 mm	169 x 57 x 19 mm	164 x 38 x 25 mm
Dimming / Dimmerazione / Dimmung / Variateur de lumière	ON/OFF	ON/OFF	DIM PUSH / DALI / 0-10V / 1-10V
Input / ingresso / Eingang / Entrée	IN 220-240V~	IN 220-240V~	IN 220-240V~

1116A ALFIERE SMALL

Designed by Giacomo Edi

EN ALFIERE's discrete presence illuminates paths with a soft light. Sharp and gentle contrasting lines strike a balance in this reassuring-looking object. Its shape recalls a piece of urban furnishing or the image of a chess piece. Its central body's oblique and functional sign allows for a broad diffusion of frontal light.

IT La presenza discreta di ALFIERE illumina il percorso di una luce gentile. Le linee nette e morbide a contrasto trovano equilibrio in quest'oggetto dall'aspetto rassicurante. La forma richiama il contesto d'arredo urbano e l'immagine della pedina degli scacchi. Il segno obliquo e funzionale del corpo centrale permette di diffondere ampia luce frontale.

DE ALFIERE beleuchtet den Weg dank seiner diskreten Präsenz mit mildem Licht. Die klaren, weichen kontrastierenden Linien finden in diesem beruhigend wirkenden Gegenstand ihr Gleichgewicht. Die Form erinnert an Stadtmobiliar und das Bild der Schachfigur des Läufers. Dank des zweckmäßigen schrägen Schnitts kann ein breites frontales Licht ausgestrahlt werden.

FR La présence discrète d'ALFIERE éclaire le chemin d'une lumière douce. Le contraste entre les lignes nettes et douces trouve un équilibre dans cet objet à l'aspect rassurant. La forme rappelle le contexte du mobilier urbain et l'image du pion du jeu d'échec. Le trait oblique et fonctionnel du corps central permet à la lumière frontale de se diffuser amplement.



Art. 1116A-396-41



Art.
1116A

Pathmarkers
Segnapassi
Orientierungsbeleuchtung
Balisages



Art. 1116A-396-41, 1116B-396-41



Article code* / Codice articolo* / Artikelnummer* / Code de l'article*
1116A-396-41

Weight / Peso / Gewicht / Poids
4 Kg

Materials / Materiali / Materialien / Matériaux
BETALY®

Light source / Sorgente luminosa / Leuchtmittel / Source lumineuse
E27 MAX 20W
Lamp not included / Lampadina non inclusa
Leuchtmittel nicht im Lieferumfang enthalten / Ampoule n'est pas fournie

Tension / Tensione / Spannung / Tension
240Vac 50/60Hz

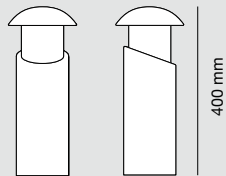

*Colors of the material / Colori del materiale / Farben der Materialien / Couleurs des matériaux



On request available in white dyeable color / Disponibile su richiesta in finitura bianca colorabile
Auf Anfrage in weißer einfärbbarer Farbe erhältlich / Sur demande disponible en couleur blanche teintable

Range Collection / Collezione / Range-Kollektion / Collection Range

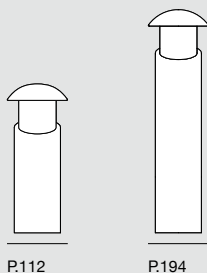

1117 VIMA

Designed by Tommaso Andolfatto

EN VIMA is a mobile lamp and reinterpretation of the ancient lantern, which can be used outdoors as a pathmarker or decorative lamp. Light cuts through its recessed cylindrical form, providing warm diffused lighting that favours visual comfort. Made of BETALY®, it is a curious-looking object even when turned off.

IT VIMA è una lampada mobile che reinterpreta la lanterna antica, utilizzabile all'esterno come segnapasso o lampada decorativa. La luce taglia il volume cilindrico recesso, restituisce un'illuminazione calda e diffusa che favorisce il comfort visivo. Il materiale BETALY® lo rende un oggetto dall'aspetto curioso anche da spento.

DE VIMA ist eine Lampe, die eine Neuinterpretation der alten Laterne darstellt und im Außenbereich als Orientierungsleuchte oder Dekorlampe verwendbar ist. Das Licht durchtrennt das zurückversetzte Zylindervolumen und sorgt für eine warme, diffuse Beleuchtung, die den visuellen Komfort begünstigt. Dank des Materials BETALY® erweckt dieses Objekt auch ausgeschaltet die Neugierde.

FR VIMA est une lampe mobile qui réinterprète la lanterne antique. Elle peut être utilisée à l'extérieur comme spots de jalonnement ou lampe décorative. La lumière traverse le volume cylindrique encastré, en fournissant un éclairage chaud et diffus qui favorise le confort visuel. Le matériau BETALY® en fait un objet à l'aspect curieux même lorsqu'il est éteint.



Art. 1117-393-3012





Art. 1117-394-3012

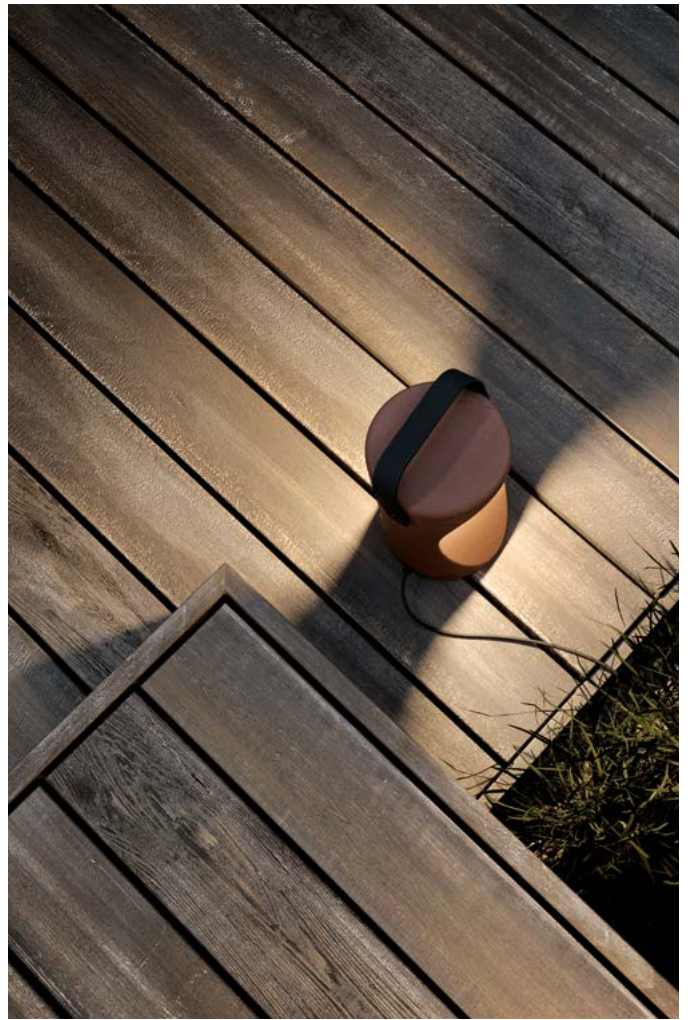



Art. 1117-394-3012

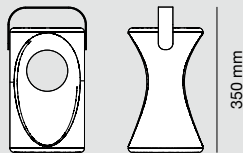

ø180 mm

Article code* / Codice articolo* / Artikelnummer* / Code de l'article*
1117-396-3012

Weight / Peso / Gewicht / Poids
8,0 Kg

Materials / Materiali / Materialien / Matériaux
BETALY®

Light source / Sorgente luminosa / Lichtquelle / Source lumineuse
LED 10W

Tension / Tensione / Spannung / Tension
240Vac 50-60Hz

ON/OFF Driver included inside / Driver ON/OFF incluso all'interno
Inklusive ON/OFF Betriebsgerät / Alimentation ON/OFF incluse

Colour temperature / Tonalità / Farbtemperatur / Température de couleur
3000°K

Lumen
800lm

CRI
80

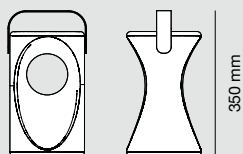
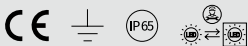

ø180 mm

Article code* / Codice articolo* / Artikelnummer* / Code de l'article*
1117-396-30160

Weight / Peso / Gewicht / Poids
8,0 Kg

Materials / Materiali / Materialien / Matériaux
BETALY®

Light source / Sorgente luminosa / Lichtquelle / Source lumineuse
LED 6W

Tension / Tensione / Spannung / Tension
24Vdc

Remote constant voltage driver is required / Necessita di alimentatore remoto tensione costante
Benötigt externe Spannungsversorgung / Alimentateur à tension constante déporté nécessaire

Colour temperature / Tonalità / Farbtemperatur / Température de couleur
3000°K

On request available in other color temperatures / Disponibile su richiesta anche con altre temperature colore
Auf Anfrage in anderen Farbtemperaturen erhältlich / Sur demande disponible dans d'autres températures de couleur

Lumen
800lm

CRI
80

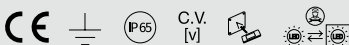



On request available in white dyeable color / Disponibile su richiesta in finitura bianca colorabile
 Auf Anfrage in weißer einfärbbarer Farbe erhältlich / Sur demande disponible en couleur blanche teintable

Accessories / Accessori / Zubehöre / Accessoires

Power supply code / Codice alimentatore / Netzgerät Code / Code driver	026.258	026.259	026.301
Power / Potenza / Leistung / Puissance	12W - 24Vdc	36W - 24Vdc	24W - 24Vdc
Protection degree / Grado di protezione / Schutzklasse / Degré de protection	IP20	IP20	IP20
Measurements / Misure / Abmessungen / Dimensions	112 x 45 x 16 mm	169 x 57 x 19 mm	164 x 38 x 25 mm
Dimming / Dimmerazione / Dimmung / Variateur de lumière	ON/OFF	ON/OFF	DIM PUSH / DALI / 0-10V / 1-10V
Input / ingresso / Eingang / Entrée	IN 220-240V~	IN 220-240V~	IN 220-240V~

1119 PASSO

Designed by Luciano Michele Lettieri

EN PASSO is a pathmarker that idealizes the shape of classic theatre lights. In addition to lighting the scene, it enhances the forms of those who fall within its radius of light. The concreteness of the BETALY® material that covers the structure is associated with the impalpable lightness emanating from its large luminous sphere.

IT PASSO è un segnapasso che idealizza le forme dei classici fari teatrali. Oltre ad illuminare la scena, esalta la figura di coloro che rientrano nel suo raggio luminoso. La concretezza del materiale BETALY® che riveste la struttura si associa all'impalpabile leggerezza emanata dalla grande sfera luminosa.

DE PASSO ist eine Orientierungsleuchte, die die Formen der klassischen Theaterscheinwerfer idealisiert. Er beleuchtet nicht nur die Szene, sondern bringt die Figur der Menschen zur Geltung, die in seinen Lichtstrahl eintreten. Die Konkretheit des Materials BETALY®, mit dem die Struktur verkleidet ist, wird mit der nicht greifbaren Leichtigkeit verbunden, die die große Leuchtkugel ausstrahlt.

FR PASSO est un spot de jalonnement qui prend la forme idéale des luminaires de théâtre classiques. En plus d'éclairer la scène, il met en valeur la silhouette de ceux qui pénètrent dans son faisceau lumineux. Le caractère concret du matériau BETALY® qui recouvre la structure se conjugue à la légèreté impalpable qui émane de la grande sphère lumineuse.

Pathmarkers
Segnapassi
Orientierungsbeleuchtung
Ballsages



Art. 1119-396-41



Art.
1119

Pathmarkers
Segnapassi
Orientierungsbeleuchtung
Balisages



Art. 1119-396-41



Article code* / Codice articolo* / Artikelnummer* / Code de l'article*
1119-396-41

Weight / Peso / Gewicht / Poids
11,0 Kg

Materials / Materiali / Materialien / Matériaux
BETALY®

Light source / Sorgente luminosa / Lichtquelle / Source lumineuse
E27 MAX 20W

Lamp not included / Lampadina non inclusa
Leuchtmittel nicht im Lieferumfang enthalten / Ampoule n'est pas fournie

Tension / Tensione / Spannung / Tension
240Vac 50/60Hz

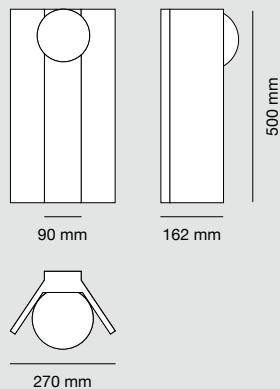

*Colors of the material / Colori del materiale / Farben der Materialien / Couleurs des matériaux



On request available in white dyeable color / Disponibile su richiesta in finitura bianca colorabile
Auf Anfrage in weißer einfärbbarer Farbe erhältlich / Sur demande disponible en couleur blanche teintable

1120 CHARTA

Designed by Danilo De Rossi

EN This essential pathmarker is born from the intuition triggered by a simple gesture, almost a game: that of folding a sheet of paper and joining its edges, in order to create a hiding place for light. The result is a mantle that rests on the ground and protects the light source, emitting an enveloping luminosity.

IT Questo essenziale segnapasso nasce dall'intuizione innescata da un gesto semplice, quasi un gioco: quello di piegare un foglio di carta unendo le sommità al fine di creare un nascondiglio per la luce. Ne deriva un manto che poggia a terra e protegge la sorgente luminosa emanando una luminosità avvolgente.

DE Diese schlichte Orientierungsleuchte entspringt einer Intuition, die durch eine einfache Geste, beinahe ein Spiel ausgelöst wurde: Die des Faltens von Papier, indem die Enden zusammengeführt werden, um ein Versteck für das Licht zu schaffen. Das Ergebnis ist ein Umhang, der auf dem Boden aufliegt und die Lichtquelle schützt, während sie eine einhüllende Helligkeit ausstrahlt.

FR Ce spot de jalonnement sobre est né de l'intuition déclenchée par un geste simple, presque un jeu: celui de plier une feuille de papier en joignant les sommets afin de créer une cachette pour la lumière. C'est un voile qui repose sur le sol et protège la source de lumière, en dégageant une luminosité enveloppante.



Art. 1120-392-30179



Art. 1120-395-30179



Article code* / Codice articolo* / Artikelnummer* / Code de l'article*
1120-396-30179

Weight / Peso / Gewicht / Poids
17,0 Kg

Materials / Materiali / Materialien / Matériaux
BETALY®

Light source / Sorgente luminosa / Lichtquelle / Source lumineuse
LED 6W

Tension / Tensione / Spannung / Tension
24Vdc

Remote constant voltage driver is required / Necessita di alimentatore remoto tensione costante
Benötigt externe Spannungsversorgung / Alimentateur à tension constante déporté nécessaire

Colour temperature / Tonalità / Farbtemperatur / Température de couleur
3000°K

On request available in other color temperatures / Disponibile su richiesta anche con altre temperature colore
Auf Anfrage in anderen Farbtemperaturen erhältlich / Sur demande disponible dans d'autres températures de couleur

Lumen
800lm

CRI
80

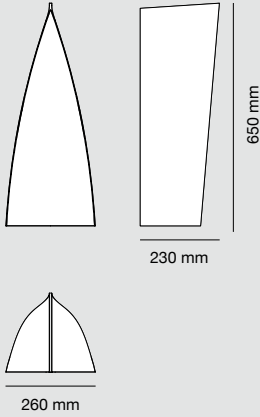

*Colors of the material / Colori del materiale / Farben der Materialien / Couleurs des matériaux



On request available in white dyeable color / Disponibile su richiesta in finitura bianca colorabile
Auf Anfrage in weißer einfärbbarer Farbe erhältlich / Sur demande disponible en couleur blanche teintable

Accessories / Accessori / Zubehöre / Accessoires

Power supply code / Codice alimentatore / Netzgerät Code / Code driver	026.258	026.259	026.301
Power / Potenza / Leistung / Puissance	12W - 24Vdc	36W - 24Vdc	24W - 24Vdc
Protection degree / Grado di protezione / Schutzklasse / Degré de protection	IP20	IP20	IP20
Measurements / Misure / Abmessungen / Dimensions	112 x 45 x 16 mm	169 x 57 x 19 mm	164 x 38 x 25 mm
Dimming / Dimmerazione / Dimmung / Variateur de lumière	ON/OFF	ON/OFF	DIM PUSH / DALI / 0-10V / 1-10V
Input / ingresso / Eingang / Entrée	IN 220-240V~	IN 220-240V~	IN 220-240V~

1124A SEGNALINEA

1124C SEGNALINEA SMALL

Designed by 9010novantadiecì

EN SEGNALINEA owes its name to the thin slit through which it projects light. Its minimal structure consists of a long solid block into which a luminous strip is dug, enhancing the surrounding space through defined areas of light. Its vertical bollard versions go by the name of LINEA and BILINEA.

IT SEGNALINEA deve il suo nome alla sottile fessura attraverso la quale proietta la luce. La struttura minimale presenta un lungo blocco materico scavato da una fascia luminosa che esalta l'ambiente circostante attraverso porzioni definite di luce. Le versioni a paletto verticale prendono il nome di LINEA e BILINEA.

DE SEGNALINEA verdankt ihren Namen einem dünnen Schlitz, durch den sie das Licht projiziert. Die minimalistische Struktur weist einen langen Materialblock auf, der durch einen Lichtstrahl ausgehöhlt wird, der die Umgebung durch klare Lichtportionen zur Geltung bringt. Die Versionen als vertikaler Pfahl nennen sich LINEA und BILINEA.

FR SEGNALINEA doit son nom à la fine fente par laquelle il projette la lumière. Sa structure minimaliste présente un long bloc de matériau creusé d'une bande lumineuse qui met en valeur l'environnement par le biais de portions de lumière définies. Les version sur borne verticale prennent le nom de LINEA et BILINEA.



Pathmarkers
Segnapassi
Orientierungsbeleuchtung
Balisages



Art. 1124A-395-30180

Art. 1124A-395-30180, 1124C-395-30180



Art.
1124

Pathmarkers
Segnapassi
Orientierungsbeleuchtung
Balisages

9010novantadiec Outdoor

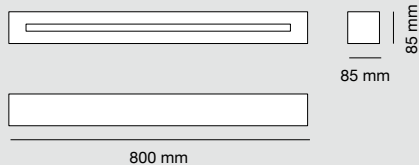

Article code* / Codice articolo* / Artikelnummer* / Code de l'article*
1124A-396-30180

Weight / Peso / Gewicht / Poids
13,4 Kg

Materials / Materiali / Materialien / Matériaux
BETALY®

Light source / Sorgente luminosa / Lichtquelle / Source lumineuse
LED 7W

Tension / Tensione / Spannung / Tension
24Vdc

Remote constant voltage driver is required / Necessita di alimentatore remoto tensione costante
Benötigt externe Spannungsversorgung / Alimentateur à tension constante déporté nécessaire

Colour temperature / Tonalità / Farbtemperatur / Température de couleur
3000°K

On request available in other color temperatures / Disponibile su richiesta anche con altre temperature colore
Auf Anfrage in anderen Farbtemperaturen erhältlich / Sur demande disponible dans d'autres températures de couleur

Lumen
800lm

CRI
80



1124C SEGNALINEA SMALL

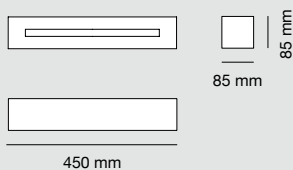

Article code* / Codice articolo* / Artikelnummer* / Code de l'article*
1124C-396-30180

Weight / Peso / Gewicht / Poids
6,5 Kg

Materials / Materiali / Materialien / Matériaux
BETALY®

Light source / Sorgente luminosa / Lichtquelle / Source lumineuse
LED 3,5W

Tension / Tensione / Spannung / Tension
24Vdc

Remote constant voltage driver is required / Necessita di alimentatore remoto tensione costante
Benötigt externe Spannungsversorgung / Alimentateur à tension constante déporté nécessaire

Colour temperature / Tonalità / Farbtemperatur / Température de couleur
3000°K

On request available in other color temperatures / Disponibile su richiesta anche con altre temperature colore
Auf Anfrage in anderen Farbtemperaturen erhältlich / Sur demande disponible dans d'autres températures de couleur

Lumen
800lm

CRI
80





On request available in white dyeable color / Disponibile su richiesta in finitura bianca colorabile
 Auf Anfrage in weißer einfärbbarer Farbe erhältlich / Sur demande disponible en couleur blanche teintable

Accessories / Accessori / Zubehör / Accessoires

Power supply code / Codice alimentatore / Netzgerät Code / Code driver	026.259	026.260	026.209
Power / Potenza / Leistung / Puissance	36W - 24Vdc	60W - 24Vdc	60W - 24Vdc
Protection degree / Grado di protezione / Schutzklasse / Degré de protection	IP20	IP20	IP20
Measurements / Misure / Abmessungen / Dimensions	169 x 57 x 19 mm	169 x 57 x 19 mm	127 x 82 x 30 mm
Dimming / Dimmerazione / Dimmung / Variateur de lumière	ON/OFF	ON/OFF	DIM PUSH/1-10V
Input / ingresso / Eingang / Entrée	IN 220-240V~	IN 220-240V~	IN 220-240V~

Power supply code / Codice alimentatore / Netzgerät Code / Code driver	026.190
Power / Potenza / Leistung / Puissance	Max 288W - 24Vdc
Protection degree / Grado di protezione / Schutzklasse / Degré de protection	IP20
Measurements / Misure / Abmessungen / Dimensions	164 x 38 x 25 mm
Dimming / Dimmerazione / Dimmung / Variateur de lumière	DIMMER DALI/PUSH/0-10V/1-10V
Input / ingresso / Eingang / Entrée	IN 12-48Vdc

Range Collection / Collezione / Range-Kollektion / Collection Range

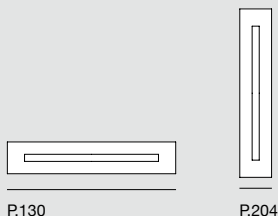

P.130

P.204

BOLLARDS
PALETTI
POLLERLEUCHTEN
BORNES



1093 ELLE

1093B ELLE SMALL

Designed by 9010novantadiecì

EN A bollard with parallelepiped shaped support and rectangular head. ELLE's essential lines harmoniously integrate its shape within a variety of different spaces, without defining the environment, but by merely using light to create a sensation of inviting welcome.

IT Il bollard con sostegno a forma di parallelepipedo e testa rettangolare. Le linee essenziali di ELLE ne integrano armoniosamente la figura all'interno di spazi tra loro anche molto diversi, senza definire l'ambiente ma utilizzando la sola luce per infondere una sensazione di invitante accoglienza.

DE Der Poller mit quaderförmiger Stütze und rechteckigem Kopf. Dank der schlichten Linien von ELLE fügt sich seine Figur harmonisch in komplett unterschiedlichen Räumen ein, ohne die Umgebung zu prägen, sondern der Einsatz des Lichtes reicht aus, um das Gefühl einer einladenden Behaglichkeit zu verbreiten.

FR Borne avec un support en forme de parallélépipède et une tête rectangulaire. Les lignes sobres d'ELLE lui permettent de s'intégrer harmonieusement dans des contextes très différents, sans définir l'environnement mais en utilisant uniquement la lumière pour insuffler un sentiment d'accueil.



Art. 1093B-395-3011, 1093-396-3011

Art. 1093B-395-3011



Art.
1093

Bollards
Paletti
Pollerleuchten
Bornes



Art. 1093B-396-3011

Art. 1093-396-3011





Art. 1093-393-3011, 1093B-393-3011



○
Stainless steel base
Base in acciaio INOX
Fuß aus Edelstahl
Base en acier inoxydable

1093 ELLE

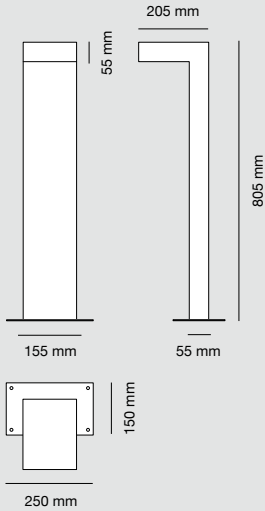

Article code* / Codice articolo* / Artikelnummer* / Code de l'article*
1093-396-3011

Weight / Peso / Gewicht / Poids
17,7 Kg

Materials / Materiali / Materialien / Matériaux
BETALY®

Light source / Sorgente luminosa / Lichtquelle / Source lumineuse
LED 10W

Tension / Tensione / Spannung / Tension
220-240Vac 50/60Hz
ON/OFF Driver included inside / Driver ON/OFF incluso all'interno
Inklusive ON/OFF Betriebsgerät / Alimentation ON/OFF incluse

Colour temperature / Tonalità / Farbtemperatur / Température de couleur
3000°K

Lumen
750lm

CRI
80

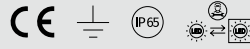

1093B ELLE SMALL

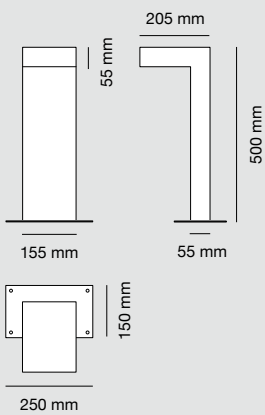

Article code* / Codice articolo* / Artikelnummer* / Code de l'article*
1093B-396-3011

Weight / Peso / Gewicht / Poids
14,7 Kg

Materials / Materiali / Materialien / Matériaux
BETALY®

Light source / Sorgente luminosa / Lichtquelle / Source lumineuse
LED 10W

Tension / Tensione / Spannung / Tension
220-240Vac 50/60Hz
ON/OFF Driver included inside / Driver ON/OFF incluso all'interno
Inklusive ON/OFF Betriebsgerät / Alimentation ON/OFF incluse

Colour temperature / Tonalità / Farbtemperatur / Température de couleur
3000°K

Lumen
750lm

CRI
80

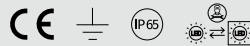

*Colors of the material / Colori del materiale / Farben der Materialien / Couleurs des matériaux



On request available in white dyeable color / Disponibile su richiesta in finitura bianca colorabile
Auf Anfrage in weißer einfärbbarer Farbe erhältlich / Sur demande disponible en couleur blanche teintable

1103A MONO

1103B DOUBLE

1103D DOUBLE SMALL

Designed by Paolo D'Arrigo

EN *"There are two ways of spreading light:
to be the candle or the mirror that reflects it".
Edith Wharton*

Binomial illumination to meet a multitude of needs, MONO & DOUBLE are two lighting structures of bold and rigorous design. A fusion of elegance and functionality.

IT *"Ci sono due modi di diffondere luce;
essere la candela o lo specchio che riflette".
Edith Wharton*

Illuminazione binomiale, per rispondere a molteplici esigenze, MONO & DOUBLE sono due strutture di luce dal design rigoroso. Un connubio di eleganza e funzionalità.

DE *"Es gibt zwei Möglichkeiten, Licht zu verbreiten; die Kerze oder der reflektierende Spiegel". Edith Wharton*

Binomiale Beleuchtung, um zahlreichen Anforderungen gerecht zu werden, sind MONO & DOUBLE zwei Lichtstrukturen mit strengem Design. Eine Kombination aus Eleganz und Funktionalität.

FR *"Il existe deux façons de diffuser la lumière; être la bougie ou le miroir qui réfléchit".
Edith Wharton*

Éclaire binomial, pour répondre à de multiples exigences, MONO & DOUBLE sont deux structures lumineuses au design rigoureux. Une combinaison d'élégance et de fonctionnalité.



Art. 1103A-396-3012



Art. 1103B-396-3012

Art. 1103B-394-3012





Art. 1103B-394-3012

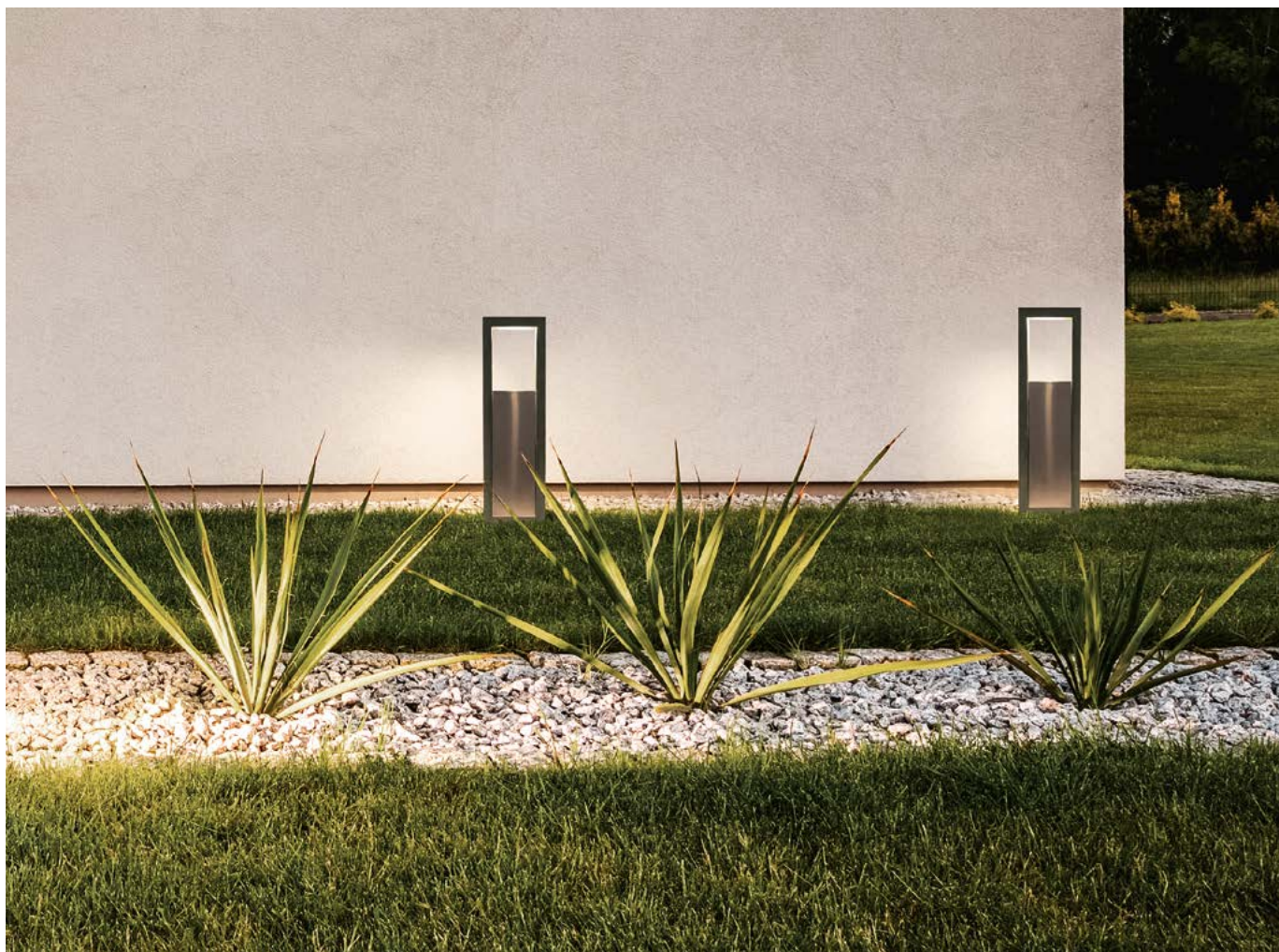

Art. 1103D-393-3012



Art. 1103B-396-3012, 1103A-396-3012

○
 Tempered etched glass
 Vetro temperato acidato
 Geätztes gehärtetes Glas
 Verre trempé

Stainless steel base
 Base in acciaio INOX
 Fuß aus Edelstahl
 Base en acier inoxydable

Satin Steel Reflector
 Riflettore in acciaio satinato
 Reflektor aus satiniertem Stahl
 Réflecteur en acier satiné

Cover-base in BETALY®
 Copri base in BETALY®
 Sockel aus BETALY®
 Couverture de la base en BETALY®
 (P251)



1103A MONO

Designed by Paolo D'Arrigo



Article code* / Codice articolo* / Artikelnummer* / Code de l'article*
1103A-396-3012

Weight / Peso / Gewicht / Poids
26 Kg

Materials / Materiali / Materialien / Matériaux
BETALY®

Light source / Sorgente luminosa / Lichtquelle / Source lumineuse
LED 10W

Tension / Tensione / Spannung / Tension
220-240Vac 50/60Hz

ON/OFF Driver included inside / Driver ON/OFF incluso all'interno
Inklusive ON/OFF Betriebsgerät / Alimentation ON/OFF incluse

Colour temperature / Tonalità / Farbtemperatur / Température de couleur
3000°K

Lumen
800lm

CRI
80

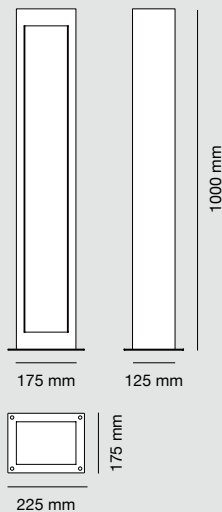
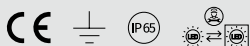

1103B DOUBLE

Designed by Paolo D'Arrigo



Article code* / Codice articolo* / Artikelnummer* / Code de l'article*
1103B-396-3012

Weight / Peso / Gewicht / Poids
24,5 Kg

Materials / Materiali / Materialien / Matériaux
BETALY®

Light source / Sorgente luminosa / Lichtquelle / Source lumineuse
LED 10W

Tension / Tensione / Spannung / Tension
220-240Vac 50/60Hz

ON/OFF Driver included inside / Driver ON/OFF incluso all'interno
Inklusive ON/OFF Betriebsgerät / Alimentation ON/OFF incluse

Colour temperature / Tonalità / Farbtemperatur / Température de couleur
3000°K

Lumen
800lm

CRI
80

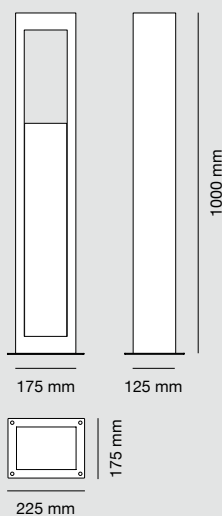
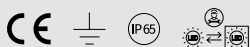

Bollards
Paletti
Pollerleuchten
Bornes

Art.
1103

9010novantadieci Outdoor

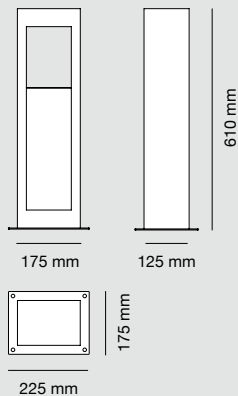

Article code* / Codice articolo* / Artikelnummer* / Code de l'article*
1103D-396-3012

Weight / Peso / Gewicht / Poids
15,4 Kg

Materials / Materiali / Materialien / Matériaux
BETALY®

Light source / Sorgente luminosa / Lichtquelle / Source lumineuse
LED 10W

Tension / Tensione / Spannung / Tension
220-240Vac 50/60Hz
ON/OFF Driver included inside / Driver ON/OFF incluso all'interno
Inklusive ON/OFF Betriebsgerät / Alimentation ON/OFF incluse

Colour temperature / Tonalità / Farbtemperatur / Température de couleur
3000°K

Lumen
800lm

CRI
80

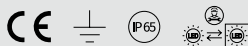

*Colors of the material / Colori del materiale / Farben der Materialien / Couleurs des matériaux



On request available in white dyeable color / Disponibile su richiesta in finitura bianca colorabile
Auf Anfrage in weißer einfärbbarer Farbe erhältlich / Sur demande disponible en couleur blanche teintable

Accessories / Accessori / Zubehöre / Accessoires

1103K Cover-base / Copri base / Sockel / Couverture de la base (P.251)

1105B BEAN

1105C BEAN BIG

Designed by Alberto Ghirardello

EN The shape of BEAN was obtained through subtraction: the completely rounded top, ideal for shedding rainwater, becomes the template for symmetrical cut-outs which house the light sources.

IT La forma di BEAN è stata ottenuta per sottrazione: una sommità a tutto tondo, funzionale alla defluizione dell'acqua piovana, diventa forma generatrice per l'intaglio simmetrico dentro la quale trova posto la sorgente luminosa.

DE Die Form von BEAN wurde durch Subtraktion erhalten: ein runde Oberseite, die den Abfluss des Regenwassers ermöglicht, wird zum Ausgangspunkt für den symmetrischen Schnitt, in dem sich die Lichtquelle befindet.

FR La forme de BEAN a été obtenue par soustraction: un sommet en ronde-bosse, laissant l'eau de pluie s'écouler, devient une forme génératrice avec l'entaille symétrique dans laquelle est positionnée la source lumineuse.

Art. 1105C-396-3012



Bollards
Paletti
Pollerleuchten
Bornes

Art.
1105

9010novantadieci Outdoor

153



Art. 1105A-392-3012 / 1105B-392-3012 / 1105C-392-3012

Art. 1105B-392-3012



Art.
1105

Bollards
Paletti
Pollerleuchten
Bornes



Art. 1105A-396-3012, 1105B-396-3012, 1105C-396-3012

○
 Tempered etched glass
 Vetro temperato acidato
 Geätztes gehärtetes Glas
 Verre trempé

Stainless steel base
 Base in acciaio INOX
 Fuß aus Edelstahl
 Base en acier inoxydable

Wiring compartment cover
 Coperchio per vano cablaggio
 Kabelanschlussraum Sockel
 Couverture du compartiment électrique

Cover-base in BETALY®
 Copri base in BETALY®
 Sockel aus BETALY®
 Couverture de la base en BETALY®
 (P.251)



1105B BEAN

Designed by Alberto Ghirardello



Article code* / Codice articolo* / Artikelnummer* / Code de l'article*
1105B-396-3012

Weight / Peso / Gewicht / Poids

15 Kg

Materials / Materiali / Materialien / Matériaux

BETALY®

Light source / Sorgente luminosa / Lichtquelle / Source lumineuse

LED 10W

Tension / Tensione / Spannung / Tension

220-240Vac 50/60Hz

ON/OFF Driver included inside / Driver ON/OFF incluso all'interno

Inklusive ON/OFF Betriebsgerät / Alimentation ON/OFF incluse

Colour temperature / Tonalità / Farbtemperatur / Température de couleur

3000°K

Lumen

800lm

CRI

80

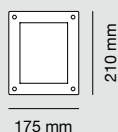
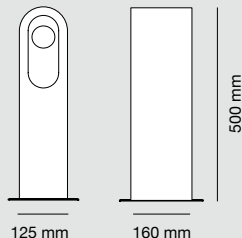
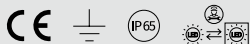

1105C BEAN BIG

Designed by Alberto Ghirardello



Article code* / Codice articolo* / Artikelnummer* / Code de l'article*
1105C-396-3012

Weight / Peso / Gewicht / Poids

22,5 Kg

Materials / Materiali / Materialien / Matériaux

BETALY®

Light source / Sorgente luminosa / Lichtquelle / Source lumineuse

LED 10W

Tension / Tensione / Spannung / Tension

220-240Vac 50/60Hz

ON/OFF Driver included inside / Driver ON/OFF incluso all'interno

Inklusive ON/OFF Betriebsgerät / Alimentation ON/OFF incluse

Colour temperature / Tonalità / Farbtemperatur / Température de couleur

3000°K

Lumen

800lm

CRI

80

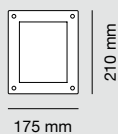
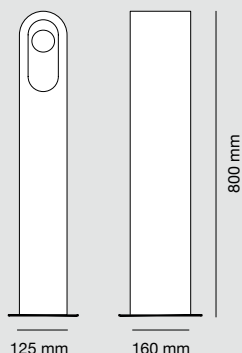
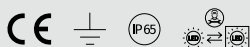

*Colors of the material / Colori del materiale / Farben der Materialien / Couleurs des matériaux



On request available in white dyeable color / Disponibile su richiesta in finitura bianca colorabile
Auf Anfrage in weißer einfärbbarer Farbe erhältlich / Sur demande disponible en couleur blanche teintable

Accessories / Accessori / Zubehör / Accessoires

1105K Cover-base / Copri base / Sockel / Couverture de la base (P.251)

Range Collection / Collezione / Range-Kollektion / Collection Range

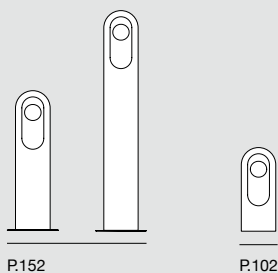

1106A MINÙ

Designed by Alberto Ghirardello

EN MINÙ is made in BETALY® in a shape which showcases the potential of the material, and consists of two distinct elements, which means the lamp can also be produced in a two-colour version.

IT MINÙ è realizzata in BETALY® dalle forme che esaltano le possibilità di impiego del materiale ed è composta da due distinti elementi, peculiarità che permette di offrire il prodotto anche in versione bicolore.

DE MINÙ ist aus BETALY® gefertigt mit Formen, die die Verwendungsmöglichkeit des Materials hervorheben und besteht aus zwei unterschiedlichen Elementen, eine Besonderheit, die es ermöglicht, das Produkt auch in zweifarbiger Version anzubieten.

FR MINÙ est en BETALY® avec des formes qui étendent les possibilités d'utilisation du matériau et se compose de deux éléments séparés, une particularité qui permet de proposer le produit aussi en version bicolore.



Art. 1106A-393-3012 + 1106Q-395

Art. 1106A-395-3012 + 1106Q-395



Art. 1106A-393-3012 + 1106Q-393





Art. 1106A-394-3012 + 1106Q-393



Art. 1106A-396-3012 + 1106Q-396

○
Stainless steel base
Base in acciaio INOX
Fuß aus Edelstahl
Base en acier inoxydable

Cover-base in BETALY®
Copri base in BETALY®
Sockel aus BETALY®
Couverture de la base en BETALY®
(P.251)





Article code* / Codice articolo* / Artikelnummer* / Code de l'article*
1106A-396-3012 + 1106Q-396

Weight / Peso / Gewicht / Poids
21 Kg

Materials / Materiali / Materialien / Matériaux
BETALY®

Light source / Sorgente luminosa / Lichtquelle / Source lumineuse
LED 10W

Tension / Tensione / Spannung / Tension
220-240Vac 50/60Hz
ON/OFF Driver included inside / Driver ON/OFF incluso all'interno
Inklusive ON/OFF Betriebsgerät / Alimentation ON/OFF incluse

Colour temperature / Tonalità / Farbtemperatur / Température de couleur
3000°K

Lumen
800lm

CRI
80

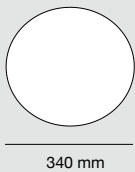
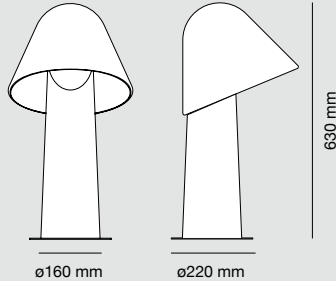
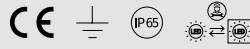

*Colors of the material / Colori del materiale / Farben der Materialien / Couleurs des matériaux



**Modular in two colours / Componibile in due colorazioni / Modulare system auf zwei Farben / Modulable en deux couleurs

On request available in white dyeable color / Disponibile su richiesta in finitura bianca colorabile
Auf Anfrage in weißer einfärbbarer Farbe erhältlich / Sur demande disponible en couleur blanche teintable

Example / Esempio / Beispiel / Exemple

Art. 1106Q-394  394

Art. 1106A-392-3012  392

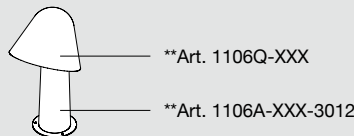

Accessories / Accessori / Zubehöre / Accessoires

1106K Cover-base / Copri base / Sockel / Couverture de la base (P.251)

1107 COBRA

Designed by Paolo D'Arrigo

EN *"We don't seek to imitate natural things, but rather explore the principles they use".*

Buckminster Fuller

A line that extends upwards from the ground and passes through the shading of light, then fluidly curves and becomes an iconic form. This is the essence of COBRA, a zoomorphic object whose shape is inspired by natural principles.

IT *"Non vogliamo imitare le cose della natura, ma piuttosto studiarne i principi di cui essa si serve". Buckminster Fuller*
Una linea che si estende dal terreno, attraversata dalla sfumatura della luce, si curva in maniera fluida, e diventa forma iconica. Questa è l'essenza di COBRA, un oggetto zoomorfo, che si ispira nelle forme ai principi della natura.

DE *"Wir wollen nicht die Natur imitieren, sondern vielmehr die Prinzipien erforschen, deren sie sich bedient". Buckminster Fuller*
Eine Linie, die sich vom Boden aus erstreckt, von den Schattierungen des Lichts durchbrochen wird, sich fließend krümmt und zu einer ikonischen Form wird. Das ist die Essenz von COBRA, einem zoomorphen Objekt, das sich in den Formen an den Prinzipien der Natur inspiriert.

FR *"Notre intention n'est pas d'imiter les choses de la nature, mais plutôt d'en étudier les principes dont elle se sert". Buckminster Fuller*
Une ligne qui s'étend à partir du sol, traversée par la nuance de la lumière elle se courbe en douceur, et devient forme iconique. Telle est l'essence de COBRA, un objet zoomorphe, inspiré dans les formes des principes de la nature.



Art. 1107-396-30159

Art. 1107-392-30159



Art.
1107

Bollards
Paletti
Pollerleuchten
Bornes



Art. 1107-396-30159

○
Tempered etched glass
Vetro temperato acidato
Geätztes gehärtetes Glas
Verre trempé satiné





Article code* / Codice articolo* / Artikelnummer* / Code de l'article*
1107-396-30159

Weight / Peso / Gewicht / Poids
17,5 Kg

Materials / Materiali / Materialien / Matériaux
BETALY®

Light source / Sorgente luminosa / Lichtquelle / Source lumineuse
LED 10W

Tension / Tensione / Spannung / Tension
220-240Vac 50/60Hz
ON/OFF Driver included inside / Driver ON/OFF incluso all'interno
Inklusive ON/OFF Betriebsgerät / Alimentation ON/OFF incluse

Colour temperature / Tonalità / Farbtemperatur / Température de couleur
3000°K

Lumen
800lm

CRI
80

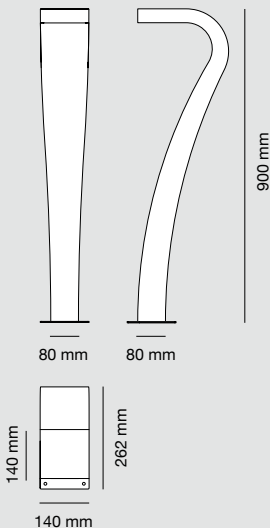
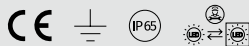

*Colors of the material / Colori del materiale / Farben der Materialien / Couleurs des matériaux



On request available in white dyeable color / Disponibile su richiesta in finitura bianca colorabile
Auf Anfrage in weißer einfärbbarer Farbe erhältlich / Sur demande disponible en couleur blanche teintable

1108A ZETA SMALL

1108B ZETA

Designed by Kalin Gemignani

EN ZETA showcases the characteristics of BETALY®, which becomes transparent as it emits two bands of light to illuminate the surroundings, creating a nocturnal ambience which makes its setting unique.

IT ZETA esalta le caratteristiche di BETALY®, che diventa trasparente emettendo due fasci luminosi che illuminano il contesto circostante, creando scenografie notturne che rendono unico l'ambiente in cui è inserita.

DE ZETA hebt die Eigenschaften von BETALY® hervor, das transparent wird und zwei Lichtstrahlen abgibt, die den umliegenden Kontext beleuchten und Nachtszenen schaffen, die die Umgebung einzigartig gestalten.

FR ZETA met l'accent sur les caractéristiques de BETALY®, qui devient transparent en émettant deux faisceaux lumineux qui éclairent l'espace environnant, en créant des scénographies nocturnes qui rendent les lieux uniques.



Art. 1108B-396-30159



Art. 1108B-396-30159

Art. 1108B-396-30159

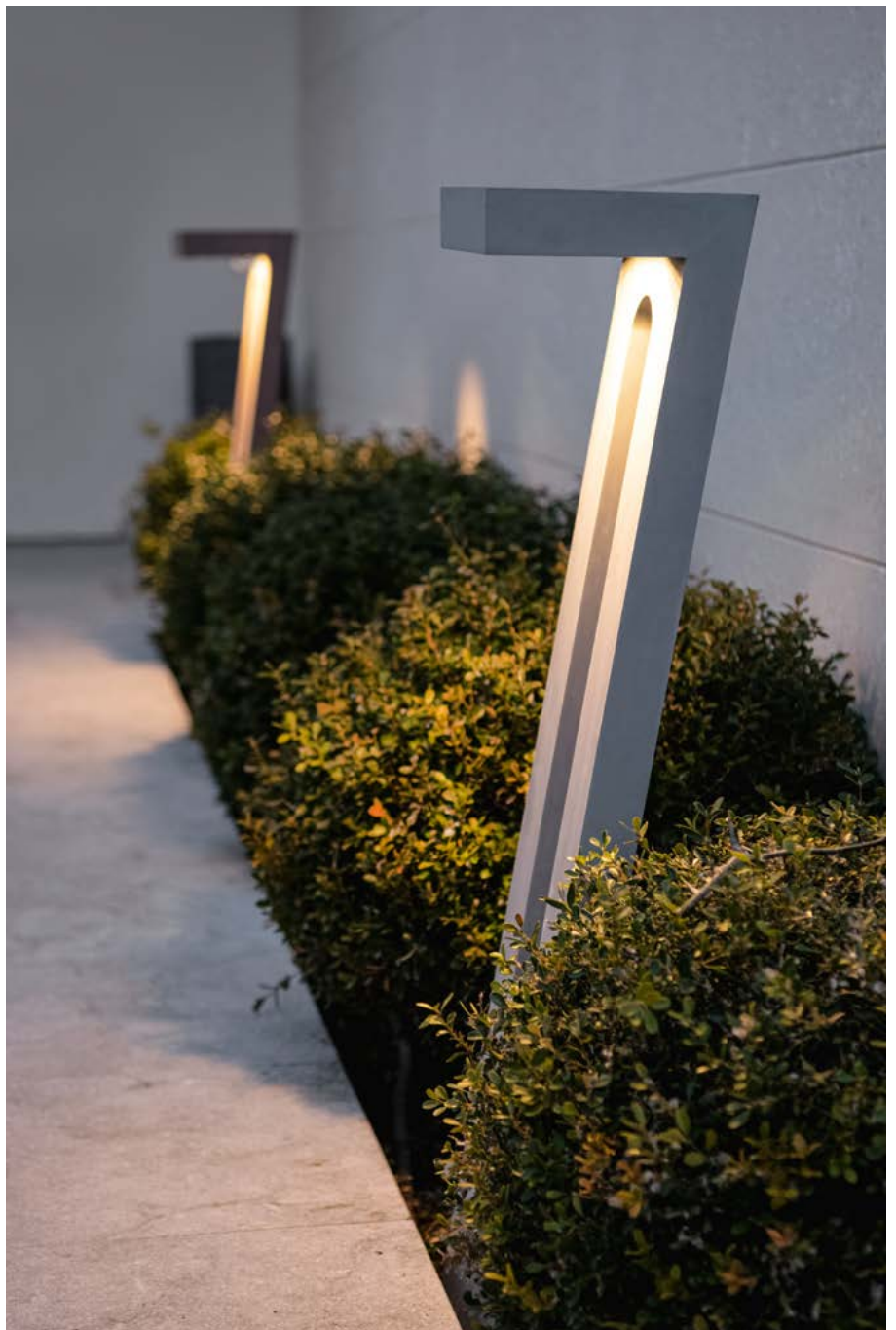



Art. 1108B-396-30159



Art. 1108B-396-30159



Art. 1108B-396-30159



Art. 1108A-396-30159

○
 Tempered etched glass
 Vetro temperato acidato
 Geätztes gehärtetes Glas
 Verre trempé satiné

Wiring and ground anchor compartment cover
 Coperchio per vano cablaggio e ancoraggio
 Kabelanschlussraum und Bodenanker Sockel
 Couverture du compartiment électrique et de l'encrage au sol



Art.
 1108

Bollards
 Paletti
 Pollerleuchten
 Bornes

1108A ZETA SMALL

Designed by Kalin Gemignani

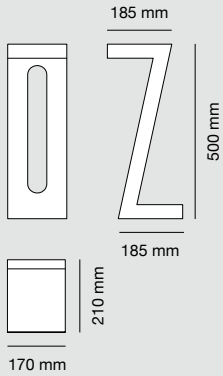

Article code* / Codice articolo* / Artikelnummer* / Code de l'article*
1108A-396-30159

Weight / Peso / Gewicht / Poids
7,5 Kg

Materials / Materiali / Materialien / Matériaux
BETALY®

Light source / Sorgente luminosa / Lichtquelle / Source lumineuse
LED 10W

Tension / Tensione / Spannung / Tension
220-240Vac 50/60Hz
ON/OFF Driver included inside / Driver ON/OFF incluso all'interno
Inklusive ON/OFF Betriebsgerät / Alimentation ON/OFF incluse

Colour temperature / Tonalità / Farbtemperatur / Température de couleur
3000°K

Lumen
800lm

CRI
80

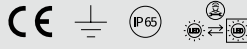

1108B ZETA

Designed by Kalin Gemignani

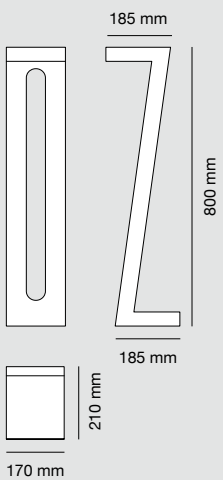

Article code* / Codice articolo* / Artikelnummer* / Code de l'article*
1108B-396-30159

Weight / Peso / Gewicht / Poids
12 Kg

Materials / Materiali / Materialien / Matériaux
BETALY®

Light source / Sorgente luminosa / Lichtquelle / Source lumineuse
LED 10W

Tension / Tensione / Spannung / Tension
220-240Vac 50/60Hz
ON/OFF Driver included inside / Driver ON/OFF incluso all'interno
Inklusive ON/OFF Betriebsgerät / Alimentation ON/OFF incluse

Colour temperature / Tonalità / Farbtemperatur / Température de couleur
3000°K

Lumen
800lm

CRI
80

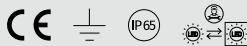

*Colors of the material / Colori del materiale / Farben der Materialien / Couleurs des matériaux



On request available in white dyeable color / Disponibile su richiesta in finitura bianca colorabile
Auf Anfrage in weißer einfärbbarer Farbe erhältlich / Sur demande disponible en couleur blanche teintable

1109 ERCOLE

Designed by Formidable Studio

EN Like a physical sign that combines aesthetics and function, a meeting point of nature and architecture, ERCOLE is characterised by a light that's indirect yet at the same time confident, ideal for outdoor spaces.

IT ERCOLE, come un segno materico che coniuga funzionalità ed estetica, punto di incontro tra natura ed architettura, è caratterizzata da una luce indiretta ma al contempo decisa, ideale per spazi outdoor.

DE ERCOLE, wie ein materielles Zeichen, das Funktionalität und Ästhetik kombiniert, ein Treffpunkt zwischen Natur und Architektur, wird durch indirektes, aber gleichzeitig starkes Licht gekennzeichnet, das sich ideal für Außenbereiche eignet.

FR ERCOLE, comme un signe de matière qui allie fonctionnalité et esthétique, point de rencontre entre nature et architecture, se caractérise par une lumière à la fois indirecte mais définie, idéale pour les espaces extérieurs.



Art. 1109-396-35



Bollards
Paletti
Pollerleuchten
Bornes



Art. 1109-396-35

○
Tempered etched glass
Vetro temperato acidato
Geätztes gehärtetes Glas
Verre trempé satiné

Painted Ral 9010 mat ALUMITE® body lamp
Struttura in ALUMITE® verniciato Ral 9010 opaco
Leuchtenkörper aus matt-lackiertem ALUMITE® Ral 9010
Corps de lampe en ALUMITE® verni Ral 9010 mat

Cover-base in BETALY® included
Copri base in BETALY® incluso
Inklusive Socket aus BETALY®
Couverture de la base en BETALY® incluse



Art. 1109-396-35





Article code* / Codice articolo* / Artikelnummer* / Code de l'article*
1109-396-35

Weight / Peso / Gewicht / Poids
10 Kg

Materials / Materiali / Materialien / Matériaux
ALUMITE® BETALY®

Light source / Sorgente luminosa / Lichtquelle / Source lumineuse
GU10 ø50 mm MAX 10W
Lamp not included / Lampadina non inclusa
Leuchtmittel nicht im Lieferumfang enthalten / Ampoule n'est pas fournie

Tension / Tensione / Spannung / Tension
240Vac 50/60Hz

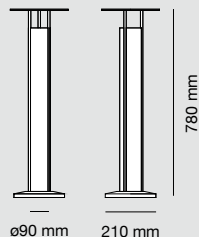

ø90 mm 210 mm



ø240 mm

*Colors of the material / Colori del materiale / Farben der Materialien / Couleurs des matériaux



On request available in white dyeable color / Disponibile su richiesta in finitura bianca colorabile
Auf Anfrage in weißer einfärbbarer Farbe erhältlich / Sur demande disponible en couleur blanche teintable

1110A LEVICO SMALL

1110B LEVICO

Designed by HENRY & CO.

EN Like a mountain spring, the light source is isolated and concealed; like the water of a river, the light carves its course through the body of the lamp, leaving behind hollows and dips which soften the diffusion.

IT Come una sorgente d'alta quota, la fonte luminosa è isolata e celata e come l'acqua di un fiume, la luce scava il suo percorso attraverso il corpo luminoso, lasciandosi dietro conche ed avvallamenti che ne ammorbidiscono la diffusione.

DE Wie eine Quelle in den Bergen ist die Lichtquelle isoliert und verborgen und wie das Wasser eines Flusses gräbt sich das Licht seinen Weg durch den Lichtkörper, wobei es Mulden und Vertiefungen hinterlässt, die seine Diffusion weicher machen.

FR Comme une source de haute altitude, la source lumineuse est isolée et masquée, et comme l'eau d'un fleuve, la lumière creuse son parcours à travers le corps lumineux, en s'immiscant derrière conques et profondeurs qui en adoucissent la diffusion.



Art. 1110B-396-3012



Art. 1110B-395-3012



Art. 1110B-396-3012



Art. 1110A-396-3012

○
Tempered etched glass
Vetro temperato acidato
Geätztes gehärtetes Glas
Verre trempé satiné

Stainless steel base
Base in acciaio INOX
Fuß aus Edelstahl
Base en acier inoxydable

Cover-base in BETALY®
Copri base in BETALY®
Sockel aus BETALY®
Couverture de la base en BETALY®
(P.251)



1110A LEVICO SMALL

Designed by HENRY & CO.



Article code* / Codice articolo* / Artikelnummer* / Code de l'article*
1110A-396-3012

Weight / Peso / Gewicht / Poids
21 Kg

Materials / Materiali / Materialien / Matériaux
BETALY®

Light source / Sorgente luminosa / Lichtquelle / Source lumineuse
LED 10W

Tension / Tensione / Spannung / Tension
220-240Vac 50/60Hz

ON/OFF Driver included inside / Driver ON/OFF incluso all'interno
Inklusive ON/OFF Betriebsgerät / Alimentation ON/OFF incluse

Colour temperature / Tonalità / Farbtemperatur / Température de couleur
3000°K

Lumen
800lm

CRI
80

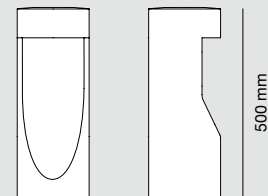
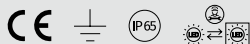

ø190 mm

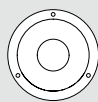

ø240 mm

1110B LEVICO

Designed by HENRY & CO.



Article code* / Codice articolo* / Artikelnummer* / Code de l'article*
1110B-396-3012

Weight / Peso / Gewicht / Poids
31 Kg

Materials / Materiali / Materialien / Matériaux
BETALY®

Light source / Sorgente luminosa / Lichtquelle / Source lumineuse
LED 10W

Tension / Tensione / Spannung / Tension
220-240Vac 50/60Hz

ON/OFF Driver included inside / Driver ON/OFF incluso all'interno
Inklusive ON/OFF Betriebsgerät / Alimentation ON/OFF incluse

Colour temperature / Tonalità / Farbtemperatur / Température de couleur
3000°K

Lumen
800lm

CRI
80

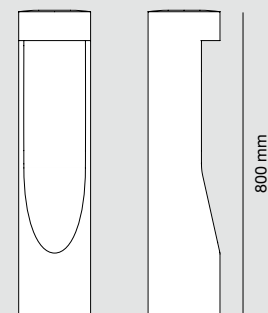
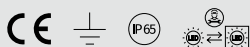

ø 190 mm

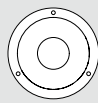

ø 240 mm

Bollards
Paletti
Pollerleuchten
Bornes

*Colors of the material / Colori del materiale / Farben der Materialien / Couleurs des matériaux



On request available in white dyeable color / Disponibile su richiesta in finitura bianca colorabile
Auf Anfrage in weißer einfärbbarer Farbe erhältlich / Sur demande disponible en couleur blanche teintable

Accessories / Accessori / Zubehör / Accessoires

1110K Cover-base / Copri base / Sockel / Couverture de la base (P.251)

Range Collection / Collezione / Range-Kollektion / Collection Range

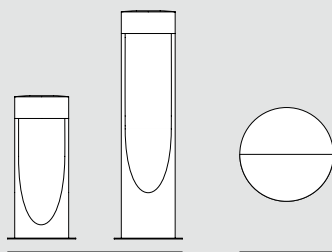

P.182

P.58

1112A OOLITE SMOOTH

1112B OOLITE GRIT

1112C OOLITE ROUGH

Designed by Maurizio Quargnale

EN OOLITE translates the relationship between nature and design into light. A respectful dialogue between functionality and essential forms is expressed through this lighting element; manufactured in extremely tactile finishes and colours, it is fully integratable green spaces. Its long and slender form can be inserted into larger spaces, such as outdoor areas bordering paths and patios, or in flowerpots and gardens.

IT OOLITE traduce in oggetto il concetto di relazione tra natura e design. Il dialogo rispettoso fra funzionalità e forme essenziali si esprime attraverso questo corpo illuminante, realizzato con colori e finiture fortemente materici e totalmente integrabile nel verde. La lunga ed esile figura si può inserire in ampi contesti come nelle aree esterne lungo percorsi e patii, all'interno di fioriere e giardini.

DE OOLITE übersetzt das Konzept der Beziehung zwischen Natur und Design in ein konkretes Objekt. Der respektvolle Dialog zwischen Zweckmäßigkeit und schlichten Formen kommt in diesem Leuchtkörper zum Ausdruck, der mit stark plastischen Farben und Ausführungen gefertigt ist, die sich perfekt in die Vegetation integrieren. Die lange, schlanke Figur kann in große Umgebungen wie etwa in den Außenbereichen entlang der Wege und Patios, in Blumentöpfe und Gärten eingefügt werden.

FR OOLITE traduit sous forme d'objet le concept de la relation entre la nature et le design. Le dialogue respectueux entre fonctionnalité et formes sobres s'exprime à travers ce luminaire, réalisé avec des coloris et des finitions fortement texturées et totalement intégré dans la verdure. La silhouette longue et élancée peut être placée dans de grands contextes tels que les espaces extérieurs le long des allées et des patios, à l'intérieur des bacs à fleurs et des jardins.



Art. 1112A-394-30173



Art. 1112A-395-30173





○
 Stainless steel painted RAL 8019
 Acciaio INOX verniciato RAL 8019
 Edelstahl lackiert RAL 8019
 Acier Inoxydable peint RAL 8019

OOLITE SMOOTH
 Art. 1112A-395-30173



OOLITE GRIT
 Art. 1112B-395-30173

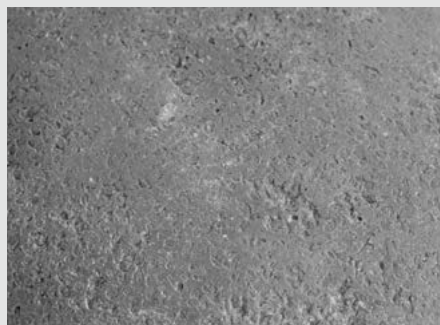

OOLITE ROUGH
 Art. 1102C-395-30173



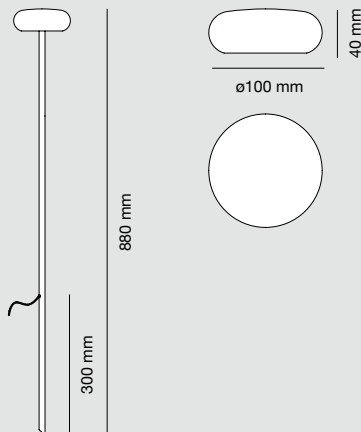

Article code* / Codice articolo* / Artikelnummer* / Code de l'article*
1112A-396-30173

Weight / Peso / Gewicht / Poids
1,0 Kg

Materials / Materiali / Materialien / Matériaux
BETALY®

Light source / Sorgente luminosa / Lichtquelle / Source lumineuse
LED 4,5W

Tension / Tensione / Spannung / Tension
24Vdc

Remote constant voltage driver is required / Necessita di alimentatore remoto tensione costante
Benötigt externe Spannungsversorgung / Alimentateur à tension constante déporté nécessaire

Colour temperature / Tonalità / Farbtemperatur / Température de couleur
3000°K

On request available in other color temperatures / Disponibile su richiesta anche con altre temperature colore
Auf Anfrage in anderen Farbtemperaturen erhältlich / Sur demande disponible dans d'autres températures de couleur

Lumen
600lm

CRI
80



1112B OOLITE GRIT

Designed by Maurizio Quargnale

NEW

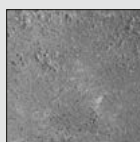
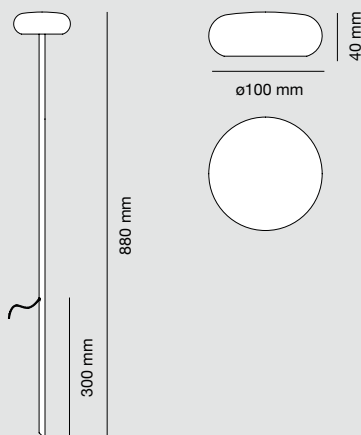

Article code* / Codice articolo* / Artikelnummer* / Code de l'article*
1112B-396-30173

Weight / Peso / Gewicht / Poids
1,0 Kg

Materials / Materiali / Materialien / Matériaux
BETALY®

Light source / Sorgente luminosa / Lichtquelle / Source lumineuse
LED 4,5W

Tension / Tensione / Spannung / Tension
24Vdc

Remote constant voltage driver is required / Necessita di alimentatore remoto tensione costante
Benötigt externe Spannungsversorgung / Alimentateur à tension constante déporté nécessaire

Colour temperature / Tonalità / Farbtemperatur / Température de couleur
3000°K

On request available in other color temperatures / Disponibile su richiesta anche con altre temperature colore
Auf Anfrage in anderen Farbtemperaturen erhältlich / Sur demande disponible dans d'autres températures de couleur

Lumen
600lm

CRI
80

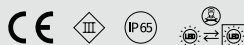

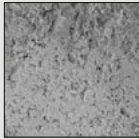
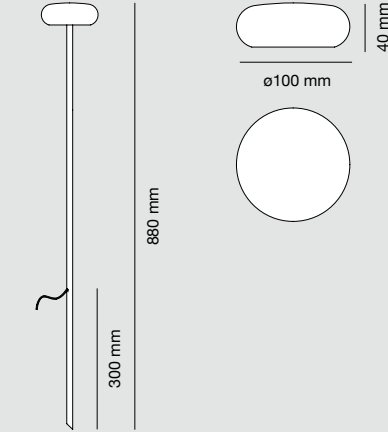

Article code* / Codice articolo* / Artikelnummer* / Code de l'article*
1102C-396-30173

Weight / Peso / Gewicht / Poids
1,0 Kg

Materials / Materiali / Materialien / Matériaux
BETALY®

Light source / Sorgente luminosa / Lichtquelle / Source lumineuse
LED 4,5W

Tension / Tensione / Spannung / Tension
24Vdc

Remote constant voltage driver is required / Necessita di alimentatore remoto tensione costante
Benötigt externe Spannungsversorgung / Alimentateur à tension constante déporté nécessaire

Colour temperature / Tonalità / Farbtemperatur / Température de couleur
3000°K

On request available in other color temperatures / Disponibile su richiesta anche con altre temperature colore
Auf Anfrage in anderen Farbtemperaturen erhältlich / Sur demande disponible dans d'autres températures de couleur

Lumen
600lm

CRI
80

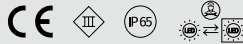

*Colors of the material / Colori del materiale / Farben der Materialien / Couleurs des matériaux



On request available in white dyeable color / Disponibile su richiesta in finitura bianca colorabile
Auf Anfrage in weißer einfärbbarer Farbe erhältlich / Sur demande disponible en couleur blanche teintable

Accessories / Accessori / Zubehöre / Accessoires

Power supply code / Codice alimentatore / Netzgerät Code / Code driver	026.258	026.259	026.301
Power / Potenza / Leistung / Puissance	12W - 24Vdc	36W - 24Vdc	24W - 24Vdc
Protection degree / Grado di protezione / Schutzklasse / Degré de protection	IP20	IP20	IP20
Measurements / Misure / Abmessungen / Dimensions	112 x 45 x 16 mm	169 x 57 x 19 mm	164 x 38 x 25 mm
Dimming / Dimmerazione / Dimmung / Variateur de lumière	ON/OFF	ON/OFF	DIM PUSH / DALI / 0-10V / 1-10V
Input / ingresso / Eingang / Entrée	IN 220-240V~	IN 220-240V~	IN 220-240V~

1116B ALFIERE

Designed by Giacomo Edi

EN ALFIERE's discrete presence illuminates paths with a soft light. Sharp and gentle contrasting lines strike a balance in this reassuring-looking object. Its shape recalls a piece of urban furnishing or the image of a chess piece. Its central body's oblique and functional sign allows for a broad diffusion of frontal light.

IT La presenza discreta di ALFIERE illumina il percorso di una luce gentile. Le linee nette e morbide a contrasto trovano equilibrio in quest'oggetto dall'aspetto rassicurante. La forma richiama il contesto d'arredo urbano e l'immagine della pedina degli scacchi. Il segno obliquo e funzionale del corpo centrale permette di diffondere ampia luce frontale.

DE ALFIERE beleuchtet den Weg dank seiner diskreten Präsenz mit mildem Licht. Die klaren, weichen kontrastierenden Linien finden in diesem beruhigend wirkenden Gegenstand ihr Gleichgewicht. Die Form erinnert an Stadtmobiliar und das Bild der Schachfigur des Läufers. Dank des zweckmäßigen schrägen Schnitts kann ein breites frontales Licht ausgestrahlt werden.

FR La présence discrète d'ALFIERE éclaire le chemin d'une lumière douce. Le contraste entre les lignes nettes et douces trouve un équilibre dans cet objet à l'aspect rassurant. La forme rappelle le contexte du mobilier urbain et l'image du pion du jeu d'échec. Le trait oblique et fonctionnel du corps central permet à la lumière frontale de se diffuser amplement.



Art. 1116B-396-41



Art.
1116B

Bollards
Paletti
Pollerleuchten
Bornes



Art. 1116B-393-41



Art. 1116B-396-41





Art. 1116A-396-41, 1116B-396-41



Article code* / Codice articolo* / Artikelnummer* / Code de l'article*
1116B-396-41

Weight / Peso / Gewicht / Poids
5,8 Kg

Materials / Materiali / Materialien / Matériaux
BETALY®

Light source / Sorgente luminosa / Lichtquelle / Source lumineuse
E27 MAX 20W

Lamp not included / Lampadina non inclusa
Leuchtmittel nicht im Lieferumfang enthalten / Ampoule n'est pas fournie

Tension / Tensione / Spannung / Tension
240Vac

Hz
50/60

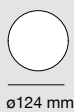
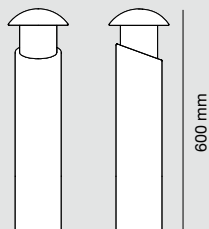

*Colors of the material / Colori del materiale / Farben der Materialien / Couleurs des matériaux



On request available in white dyeable color / Disponibile su richiesta in finitura bianca colorabile
Auf Anfrage in weißer einfärbbarer Farbe erhältlich / Sur demande disponible en couleur blanche teintable

Range Collection / Collezione / Range-Kollektion / Collection Range

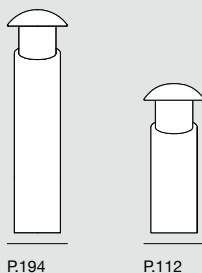

1121 ANTHEA

Designed by Alice Barki

EN ANTHEA's shape takes inspiration from the world of plants; its sinuous curves create an elegant vertical twist. Its body diffuses a soft light that emanates from thin slits running along the entire edge of the bollard. One's path is illuminated by this natural spectacle.

IT La forma prende ispirazione dal mondo vegetale; curve sinuose creano un'elegante torsione verticale. Il corpo emana una luce soffusa che percorre interamente le sottili fessure poste all'estremità laterale del bollard. Il cammino viene illuminato dallo spettacolo naturale.

DE Die Inspiration für die Form stammt aus der Pflanzenwelt; geschmeidige Kurven bringen eine elegante vertikale Torsion hervor. Der Körper strahlt ein gedämpftes Licht aus, das innen durch die schmale Spalte am seitlichen Ende des Pollers verläuft. Der Weg wird durch ein Naturschauspiel beleuchtet.

FR La forme s'inspire du monde végétal; les courbes sinueuses créent une élégante torsion verticale. Le corps lumineux émet une lumière douce qui passe entièrement par les fines fentes situées à l'extrémité latérale de la borne. Le chemin est éclairé par le spectacle naturel.





Art. 1121-396-30181

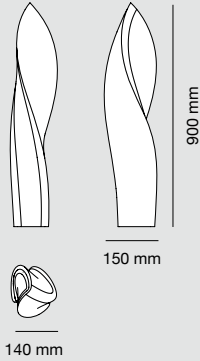

Article code* / Codice articolo* / Artikelnummer* / Code de l'article*
1121-396-30181

Weight / Peso / Gewicht / Poids
19,8 Kg

Materials / Materiali / Materialien / Matériaux
BETALY®

Light source / Sorgente luminosa / Lichtquelle / Source lumineuse
LED 14W

Tension / Tensione / Spannung / Tension
24Vdc

Remote constant voltage driver is required / Necessita di alimentatore remoto tensione costante
Benötigt externe Spannungsversorgung / Alimentateur à tension constante déporté nécessaire

Colour temperature / Tonalità / Farbtemperatur / Température de couleur
3000°K

On request available in other color temperatures / Disponibile su richiesta anche con altre temperature colore
Auf Anfrage in anderen Farbtemperaturen erhältlich / Sur demande disponible dans d'autres températures de couleur

Lumen
1400lm

CRI
80



*Colors of the material / Colori del materiale / Farben der Materialien / Couleurs des matériaux



On request available in white dyeable color / Disponibile su richiesta in finitura bianca colorabile
Auf Anfrage in weißer einfärbbarer Farbe erhältlich / Sur demande disponible en couleur blanche teintable

Accessories / Accessori / Zubehöre / Accessoires

Power supply code / Codice alimentatore / Netzgerät Code / Code driver	026.259	026.260	026.209
Power / Potenza / Leistung / Puissance	36W - 24Vdc	60W - 24Vdc	60W - 24Vdc
Protection degree / Grado di protezione / Schutzklasse / Degré de protection	IP20	IP20	IP20
Measurements / Misure / Abmessungen / Dimensions	169 x 57 x 19 mm	169 x 57 x 19 mm	127 x 82 x 30 mm
Dimming / Dimmerazione / Dimmung / Variateur de lumière	ON/OFF	ON/OFF	DIM PUSH/1-10V
Input / ingresso / Eingang / Entrée	IN 220-240V~	IN 220-240V~	IN 220-240V~

Power supply code / Codice alimentatore / Netzgerät Code / Code driver	026.190
Power / Potenza / Leistung / Puissance	Max 288W - 24Vdc
Protection degree / Grado di protezione / Schutzklasse / Degré de protection	IP20
Measurements / Misure / Abmessungen / Dimensions	164 x 38 x 25 mm
Dimming / Dimmerazione / Dimmung / Variateur de lumière	DIMMER DALI/PUSH/0-10V/1-10V
Input / ingresso / Eingang / Entrée	IN 12-48Vdc

1123A LINEA

1123B BILINEA

1123C LINEA SMALL

1123D BILINEA SMALL

Designed by 9010novantadiecì

EN LINEA and BILINEA owe their names to the thin slit through which they project light. Minimal structures that consist of a long solid block into which a luminous strip is dug, enhancing the surrounding space through defined areas of light. The horizontal pathmarker version goes by the name of SEGNALINEA.

IT LINEA e BILINEA devono il loro nome alla sottile fessura attraverso la quale proiettano la luce. La loro struttura minimale presenta un lungo blocco materico scavato da una fascia luminosa che esalta l'ambiente circostante attraverso porzioni definite di luce. La versione segnapasso orizzontale prende il nome di SEGNALINEA.

DE LINEA und BILINEA verdanken ihren Namen einem dünnen Schlitz, durch den sie das Licht projizieren. Ihre minimalistische Struktur weist einen langen Materialblock auf, der durch einen Lichtstrahl ausgehöhlt wird, der die Umgebung durch klare Lichtportionen zur Geltung bringt. Die Version als horizontale Orientierungsleuchte nennt sich SEGNALINEA.

FR LINEA et BILINEA doivent leur nom à la fine fente par laquelle ils projettent la lumière. Leur structure minimaliste présente un long bloc de matériau creusé d'une bande lumineuse qui met en valeur l'environnement par le biais de portions de lumière définies. La version spot de jalonnement horizontal prend le nom de SEGNALINEA.



Art. 1123A-396-30180

Art. 1123C-395-30180



Art.
1123

Bollards
Paletti
Pollerleuchten
Bornes



Art. 1123A-395-30180



Art. 1123C-395-30180

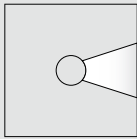
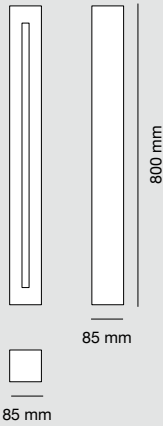

Article code* / Codice articolo* / Artikelnummer* / Code de l'article*
1123A-396-30180

Weight / Peso / Gewicht / Poids
13,4 Kg

Materials / Materiali / Materialien / Matériaux
BETALY®

Light source / Sorgente luminosa / Lichtquelle / Source lumineuse
LED 7W

Tension / Tensione / Spannung / Tension
24Vdc

Remote constant voltage driver is required / Necessita di alimentatore remoto tensione costante
Benötigt externe Spannungsversorgung / Alimentateur à tension constante déporté nécessaire

Colour temperature / Tonalità / Farbtemperatur / Température de couleur
3000°K

On request available in other color temperatures / Disponibile su richiesta anche con altre temperature colore
Auf Anfrage in anderen Farbtemperaturen erhältlich / Sur demande disponible dans d'autres températures de couleur

Lumen
800lm

CRI
80



1123B BILINEA

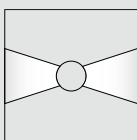
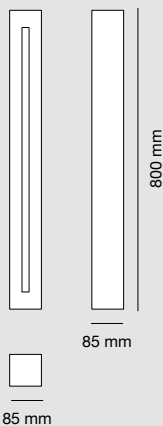

Article code* / Codice articolo* / Artikelnummer* / Code de l'article*
1123B-396-30180

Weight / Peso / Gewicht / Poids
13,4 Kg

Materials / Materiali / Materialien / Matériaux
BETALY®

Light source / Sorgente luminosa / Lichtquelle / Source lumineuse
LED 14W

Tension / Tensione / Spannung / Tension
24Vdc

Remote constant voltage driver is required / Necessita di alimentatore remoto tensione costante
Benötigt externe Spannungsversorgung / Alimentateur à tension constante déporté nécessaire

Colour temperature / Tonalità / Farbtemperatur / Température de couleur
3000°K

On request available in other color temperatures / Disponibile su richiesta anche con altre temperature colore
Auf Anfrage in anderen Farbtemperaturen erhältlich / Sur demande disponible dans d'autres températures de couleur

Lumen
800lm

CRI
80



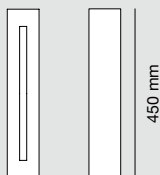

85 mm



85 mm

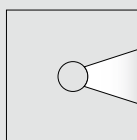

Article code* / Codice articolo* / Artikelnummer* / Code de l'article*
1123C-396-30180

Weight / Peso / Gewicht / Poids
6,5 Kg

Materials / Materiali / Materialien / Matériaux
BETALY®

Light source / Sorgente luminosa / Lichtquelle / Source lumineuse
LED 3,5W

Tension / Tensione / Spannung / Tension
24Vdc

Remote constant voltage driver is required / Necessita di alimentatore remoto tensione costante
Benötigt externe Spannungsversorgung / Alimentateur à tension constante déporté nécessaire

Colour temperature / Tonalità / Farbtemperatur / Température de couleur
3000°K

On request available in other color temperatures / Disponibile su richiesta anche con altre temperature colore
Auf Anfrage in anderen Farbtemperaturen erhältlich / Sur demande disponible dans d'autres températures de couleur

Lumen
800lm

CRI
80



1123D BILINEA SMALL

NEW

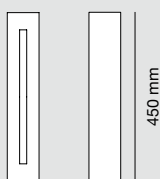

85 mm



85 mm

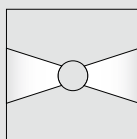

Article code* / Codice articolo* / Artikelnummer* / Code de l'article*
1123D-396-30180

Weight / Peso / Gewicht / Poids
6,5 Kg

Materials / Materiali / Materialien / Matériaux
BETALY®

Light source / Sorgente luminosa / Lichtquelle / Source lumineuse
LED 7W

Tension / Tensione / Spannung / Tension
24Vdc

Remote constant voltage driver is required / Necessita di alimentatore remoto tensione costante
Benötigt externe Spannungsversorgung / Alimentateur à tension constante déporté nécessaire

Colour temperature / Tonalità / Farbtemperatur / Température de couleur
3000°K

On request available in other color temperatures / Disponibile su richiesta anche con altre temperature colore
Auf Anfrage in anderen Farbtemperaturen erhältlich / Sur demande disponible dans d'autres températures de couleur

Lumen
800lm

CRI
80





On request available in white dyeable color / Disponibile su richiesta in finitura bianca colorabile
 Auf Anfrage in weißer einfärbbarer Farbe erhältlich / Sur demande disponible en couleur blanche teintable

Accessories / Accessori / Zubehör / Accessoires

Power supply code / Codice alimentatore / Netzgerät Code / Code driver	026.259	026.260	026.209
Power / Potenza / Leistung / Puissance	36W - 24Vdc	60W - 24Vdc	60W - 24Vdc
Protection degree / Grado di protezione / Schutzklasse / Degré de protection	IP20	IP20	IP20
Measurements / Misure / Abmessungen / Dimensions	169 x 57 x 19 mm	169 x 57 x 19 mm	127 x 82 x 30 mm
Dimming / Dimmerazione / Dimmung / Variateur de lumière	ON/OFF	ON/OFF	DIM PUSH/1-10V
Input / ingresso / Eingang / Entrée	IN 220-240V~	IN 220-240V~	IN 220-240V~

Power supply code / Codice alimentatore / Netzgerät Code / Code driver	026.190
Power / Potenza / Leistung / Puissance	Max 288W - 24Vdc
Protection degree / Grado di protezione / Schutzklasse / Degré de protection	IP20
Measurements / Misure / Abmessungen / Dimensions	164 x 38 x 25 mm
Dimming / Dimmerazione / Dimmung / Variateur de lumière	DIMMER DALI/PUSH/0-10V/1-10V
Input / ingresso / Eingang / Entrée	IN 12-48Vdc

Range Collection / Collezione / Range-Kollektion / Collection Range



P.204

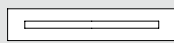

P.130

WALL RECESSED LIGHTING
INCASSO A PARETE
WAND-EINBAULEUCHTEN
ENCASTRÉS MURAUX



1301A CAVE SMALL

1301B CAVE

1301C CAVE BIG

1301D CAVE X

1301E CAVE S

Designed by 9010novantadieci

EN This line, whose indoor version is already very popular, is characterised by 9010novantadieci's unmistakable design style. The recessed model for exteriors comes in different sizes, and offers a range of possibilities in terms of how it interacts with the environment, organically adapting its shapes to the context into which it is inserted.

IT La linea, già molto apprezzata nella versione da interno, è caratterizzata dal design riconoscibile di 9010. Il modello da incasso per esterni presenta differenti misure ed offre molteplici possibilità di interazione con l'ambiente, adattando in maniera organica le sue forme al contesto nel quale si inserisce.

DE Die bereits in der Version für den Innenbereich besonders geschätzte Linie zeichnet sich durch das erkenntliche Design von 9010novantadieci aus. Das Einbaumodell für den Außenbereich hat verschiedene Abmessungen und bietet zahlreiche Möglichkeiten der Interaktion mit der Umgebung, da es sich auf organische Weise an ihre Formen und den Kontext, in den es eingefügt wird, anpasst.

FR La ligne, déjà très appréciée dans la version intérieure, se distingue par le design reconnaissable de 9010novantadieci. Le modèle encastré pour l'extérieur se décline en différentes tailles et offre de multiples possibilités d'interaction avec l'environnement, en adaptant organiquement ses formes au contexte dans lequel il s'insère.





Art. 1301C, 1301D

Art. 1301C, 1301D



Art.
1301

Wall recessed lighting
Incasso a parete
Wand-Einbauleuchten
Encastrés muraux

9010novantadieci Outdoor



Art. 1301E

Art. 1301E



Art.
1301

Wall recessed lighting
Incasso a parete
Wand-Einbauleuchten
Encastrés muraux

9010novantadieci Outdoor

217



Art. 1301A, 1301B, 1301C, 1301D, 1301E

1301A CAVE SMALL

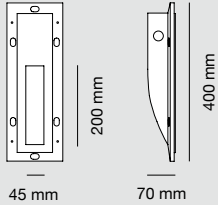

Article code / Codice articolo / Artikelnummer / Code de l'article
1301A-392-35

Weight / Peso / Gewicht / Poids
3,1 Kg

Materials / Materiali / Materialien / Matériaux
BETALY®

Light hole / Foro luce / Bohrung / Trou lumière
45 × 200 mm

Light source / Sorgente luminosa / Lichtquelle / Source lumineuse

GU10 ø35 mm MAX 10W

Lamp not included / Lampadina non inclusa

Leuchtmittel nicht im Lieferumfang enthalten / Ampoule n'est pas fournie

Tension / Tensione / Spannung / Tension

240Vac 50/60Hz



1301B CAVE

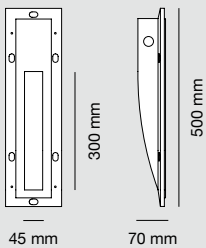

Article code / Codice articolo / Artikelnummer / Code de l'article
1301B-392-35

Weight / Peso / Gewicht / Poids
3,9 Kg

Materials / Materiali / Materialien / Matériaux
BETALY®

Light hole / Foro luce / Bohrung / Trou lumière
45 × 300 mm

Light source / Sorgente luminosa / Lichtquelle / Source lumineuse

GU10 ø35 mm MAX 10W

Lamp not included / Lampadina non inclusa

Leuchtmittel nicht im Lieferumfang enthalten / Ampoule n'est pas fournie

Tension / Tensione / Spannung / Tension

240Vac 50/60Hz



1301C CAVE BIG



Article code / Codice articolo / Artikelnummer / Code de l'article
1301C-392-35

Weight / Peso / Gewicht / Poids
4,3 Kg

Materials / Materiali / Materialien / Matériaux
BETALY®

Light hole / Foro luce / Bohrung / Trou lumière
70 × 305 mm

Light source / Sorgente luminosa / Lichtquelle / Source lumineuse
GU10 ø50 mm MAX 15W
Lamp not included / Lampadina non inclusa
Leuchtmittel nicht im Lieferumfang enthalten / Ampoule n'est pas fournie

Tension / Tensione / Spannung / Tension
240Vac 50/60Hz

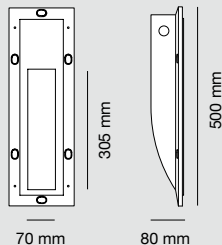

1301D CAVE X



Article code / Codice articolo / Artikelnummer / Code de l'article
1301D-392-27168 / -30168 / -40168

Weight / Peso / Gewicht / Poids
7,3 Kg

Materials / Materiali / Materialien / Matériaux
BETALY®

Light hole / Foro luce / Bohrung / Trou lumière
400 × 180 mm

Light source / Sorgente luminosa / Lichtquelle / Source lumineuse
LED 17W

Tension / Tensione / Spannung / Tension
24Vdc

Remote constant voltage driver is required / Necessita di alimentatore remoto tensione costante
Benötigt externe Spannungsversorgung / Alimentateur à tension constante déporté nécessaire

Color temperature / Tonalità / Farbtemperatur / Température de couleur
2700°K / 3000°K / 4000°K

CRI
90 / 80 / 90

Lumen
1220lm / 1290lm / 1350lm

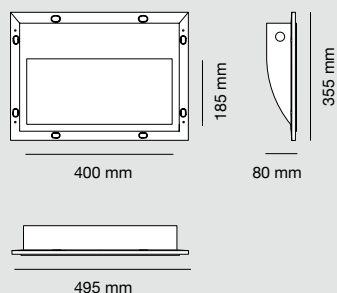

Wall recessed lighting
Incasso a parete
Wand-Einbauleuchten
Encastrés muraux

1301E CAVE S

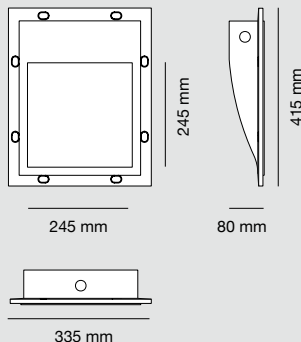

Article code / Codice articolo / Artikelnummer / Code de l'article

1301E-392-27168 / -30168 / -40168

Weight / Peso / Gewicht / Poids

5,5 Kg

Materials / Materiali / Materialien / Matériaux

BETALY®

Light hole / Foro luce / Bohrung / Trou lumière

245 x 245 mm

Light source / Sorgente luminosa / Lichtquelle / Source lumineuse

LED 10W

Tension / Tensione / Spannung / Tension

24Vdc

Remote constant voltage driver is required / Necessita di alimentatore remoto tensione costante

Benötigt externe Spannungsversorgung / Alimentateur à tension constante déporté nécessaire

Color temperature / Tonalità / Farbtemperatur / Température de couleur

2700°K / 3000°K / 4000°K

CRI

90 / 80 / 90

Lumen

680lm / 720lm / 750lm



Colors of the material / Colori del materiale / Farben der Materialien / Couleurs des matériaux



392

Accessories / Accessori / Zubehör / Accessoires

Power supply code / Codice alimentatore / Netzgerät Code / Code driver	026.259	026.260	026.301
Power / Potenza / Leistung / Puissance	36W - 24Vdc	60W - 24Vdc	24W - 24Vdc
Protection degree / Grado di protezione / Schutzklasse / Degré de protection	IP20	IP20	IP20
Measurements / Misure / Abmessungen / Dimensions	169 x 57 x 19 mm	169 x 57 x 19 mm	164 x 38 x 25 mm
Dimming / Dimmerazione / Dimmung / Variateur de lumière	ON/OFF	ON/OFF	DIM PUSH / DALI / 0-10V / 1-10V
Input / ingresso / Eingang / Entrée	IN 220-240V~	IN 220-240V~	IN 220-240V~

1302A DIAGO

1303 ASTRON CERCHIO

1305A ASTRON SMALL

1305B ASTRON

Designed by 9010novantadiecì

EN This series of wall-recessed fixtures was inspired by basic forms, and grows in the rays of light. Its pure forms lend themselves to stylishly furnishing your entire garden space, creating areas of enveloping shadows and intense light.

IT Questa serie di incassi a parete nasce dalle geometrie fondamentali e cresce nel segno della luce. Le sue forme pure si prestano ad arredare finemente l'intera zona del giardino, creando porzioni di ombra avvolgente e di luce densa.

DE Diese Einbauleuchterserie für die Wand entstammt den Grundgeometrien und wächst im Zeichen des Lichts. Ihre puren Formen eignen sich für die stilvolle Gestaltung des ganzen Gartenbereichs und unterteilen den Raum in Portionen aus einhüllendem Schatten und dichtem Licht.

FR Cette série de spots muraux encastrés naît de géométries fondamentales et se développe sous le signe de la lumière. Ses formes pures se prêtent à une décoration subtile de tout l'espace jardin, en créant des portions d'ombre enveloppante et de lumière dense.

Wall recessed lighting
Incasso a parete
Wand-Einbauleuchten
Encastrés muraux

Art.
1302, 1303, 1305

9010novantadiecì Outdoor



Art. 1303

Art. 1305A



Wall recessed lighting
Incasso a parete
Wand-Einbauleuchten
Encastrés muraux

Art.
1302, 1303, 1305

9010novantadiecì Outdoor



Art. 1305A



Art. 1302A



Art. 1302A

○
Ceiling installation available
Installabile anche a plafone
Deckenmontage möglich
Installation au plafond disponible



Art. 1303

○
Ceiling installation available
Installabile anche a plafone
Deckenmontage möglich
Installation au plafond disponible

Art. 1305A



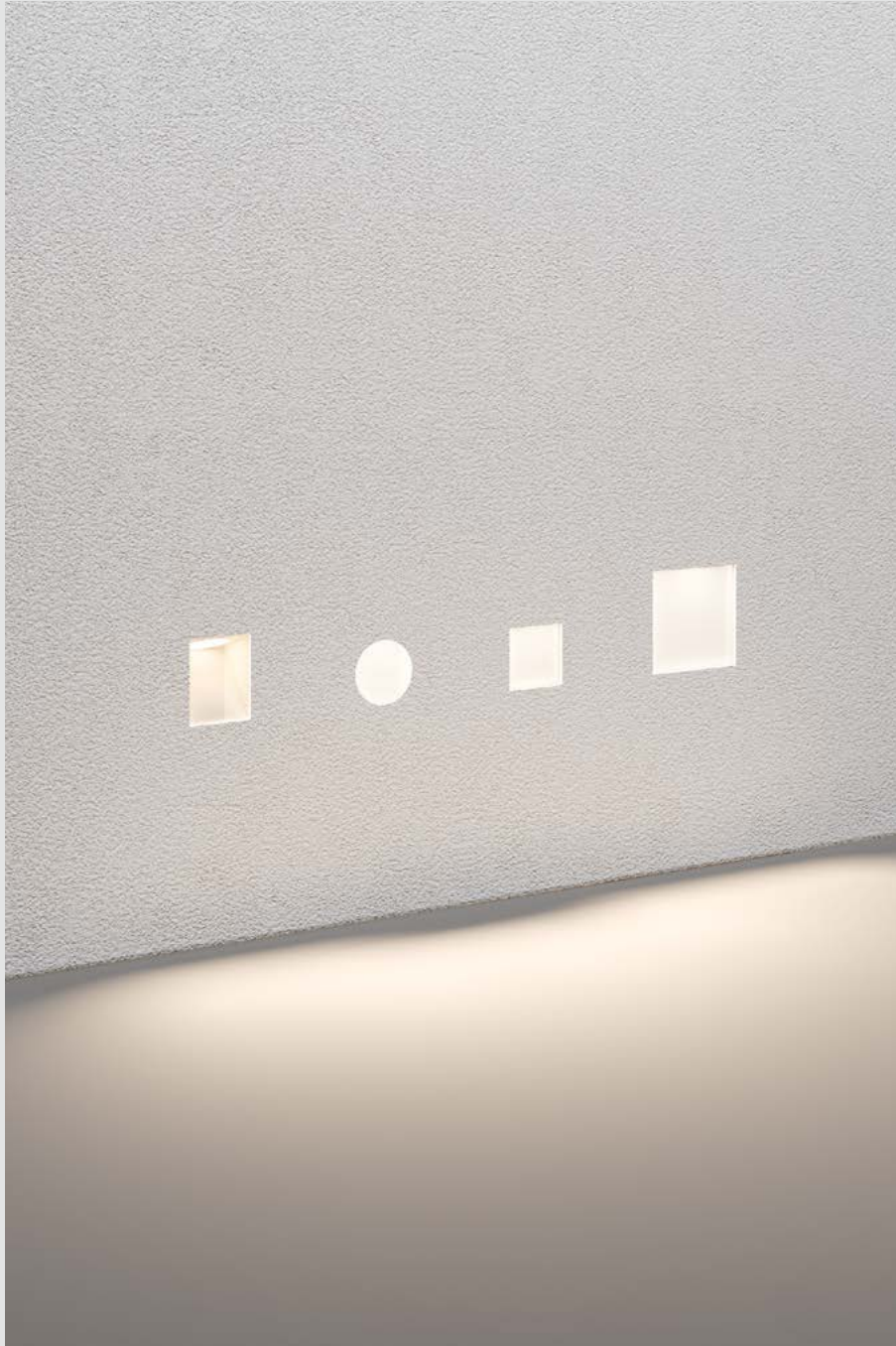

Art. 1302A, 1303, 1305A, 1305B

1302A DIAGO

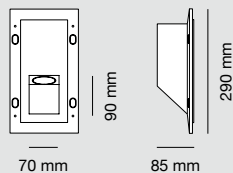

Article code / Codice articolo / Artikelnummer / Code de l'article
1302A-392-35

Weight / Peso / Gewicht / Poids
2,4 Kg

Materials / Materiali / Materialien / Matériaux
BETALY®

Light hole / Foro luce / Bohrung / Trou lumière
70 x 90 mm

Light source / Sorgente luminosa / Lichtquelle / Source lumineuse
GU10 ø35 mm MAX 10W

Lamp not included / Lampadina non inclusa
Leuchtmittel nicht im Lieferumfang enthalten / Ampoule n'est pas fournie

Tension / Tensione / Spannung / Tension
240Vac 50/60Hz



1303 ASTRON CERCHIO

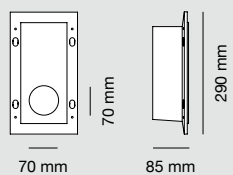

Article code / Codice articolo / Artikelnummer / Code de l'article
1303-392-35

Weight / Peso / Gewicht / Poids
3,2 Kg

Materials / Materiali / Materialien / Matériaux
BETALY®

Light hole / Foro luce / Bohrung / Trou lumière
ø70 mm

Light source / Sorgente luminosa / Lichtquelle / Source lumineuse
GU10 ø50 mm MAX 15W

Lamp not included / Lampadina non inclusa
Leuchtmittel nicht im Lieferumfang enthalten / Ampoule n'est pas fournie

Tension / Tensione / Spannung / Tension
240Vac 50/60Hz



Ceiling installation available / Installabile anche a plafone
Deckenmontage möglich / Installation au plafond disponible

Wall recessed lighting
Incasso a parete
Wand-Einbauleuchten
Encastrés muraux

1305A ASTRON SMALL



Article code / Codice articolo / Artikelnummer / Code de l'article
1305A-392-35

Weight / Peso / Gewicht / Poids
3,2 Kg

Materials / Materiali / Materialien / Matériaux
BETALY®

Light hole / Foro luce / Bohrung / Trou lumière
70 × 70 mm

Light hole / Foro luce / Bohrung / Trou lumière
GU10 ø50 mm MAX 15W

Lamp not included / Lampadina non inclusa

Leuchtmittel nicht im Lieferumfang enthalten / Ampoule n'est pas fournie

Tension / Tensione / Spannung / Tension
240Vac 50/60Hz



Ceiling installation available / Installabile anche a plafone
Deckenmontage möglich / Installation au plafond disponible

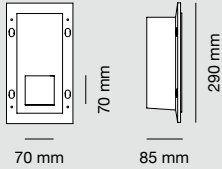

1305B ASTRON



Article code / Codice articolo / Artikelnummer / Code de l'article
1305B-392-35

Weight / Peso / Gewicht / Poids
4,2 Kg

Materials / Materiali / Materialien / Matériaux
BETALY®

Light hole / Foro luce / Bohrung / Trou lumière
120 × 120 mm

Light source / Sorgente luminosa / Lichtquelle / Source lumineuse
GU10 ø50 mm MAX 15W

Lamp not included / Lampadina non inclusa

Leuchtmittel nicht im Lieferumfang enthalten / Ampoule n'est pas fournie

Tension / Tensione / Spannung / Tension
240Vac 50/60Hz



Ceiling installation available / Installabile anche a plafone
Deckenmontage möglich / Installation au plafond disponible

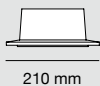
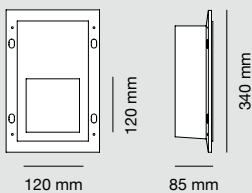

Colors of the material / Colori del materiale / Farben der Materialien / Couleurs des matériaux

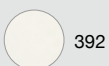

392

1304A HINT SMALL

1304B HINT

1304C HINT BIG

Designed by 9010novantadiecì

EN Geometric and minimal, this element becomes one with the wall into which it is inserted. This resistant and versatile pathmarker comes in three sizes, and creates unusual light effects and imaginative compositions that can enhance any environment or create new paths.

IT Elemento geometrico e minimale, diventa un tutt'uno con il muro nel quale si inserisce. Un segnapasso resistente e versatile in tre misure, riproduce giochi di luce inconsueti e composizioni creative per esaltare ogni tipo di ambiente o creare nuovi percorsi.

DE Geometrisches und minimalistisches Element, das ganz mit der Mauer, in die es eingefügt wird, eins wird. Eine widerstandsfähige und vielseitige Orientierungsleuchte in drei Größen, die ungewöhnliche Lichtspiele und kreative Kompositionen erzeugt, um jede Art von Umgebung zur Geltung zu bringen oder neue Wege zu schaffen.

FR Élément géométrique et minimaliste, il fait corps avec le mur dans lequel il s'insère. Ce spots de jalonnement résistant et polyvalent, disponible en trois tailles, reproduit des jeux de lumière inhabituels et des compositions créatives pour améliorer toute ambiance ou créer de nouveaux parcours.



Art. 1304B



Art. 1304A, 1304B



Art. 1304

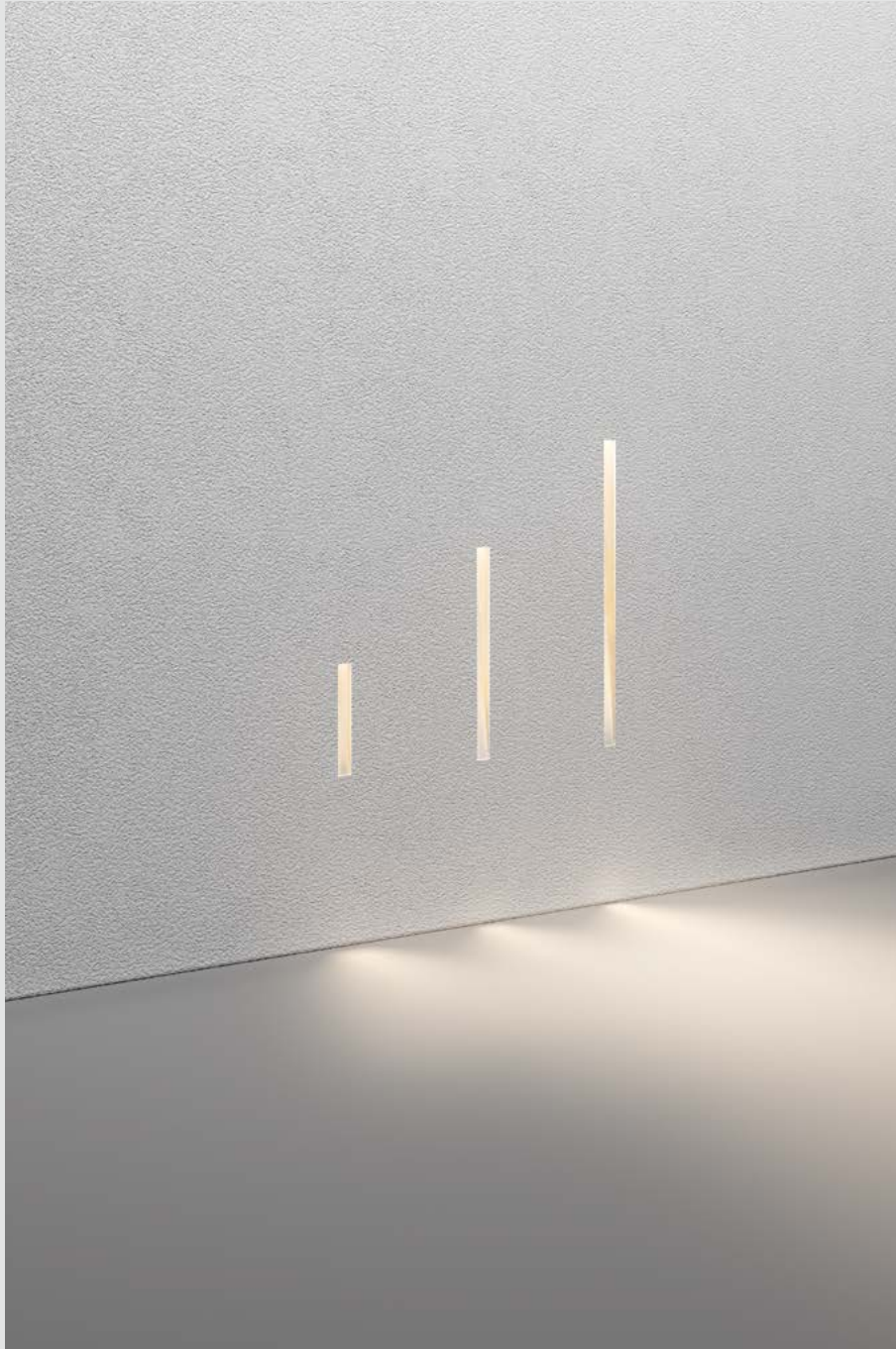

Art. 1304A, 1304B, 1304C

1304A HINT SMALL

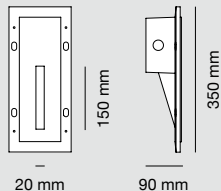

Article code / Codice articolo / Artikelnummer / Code de l'article
1304A-392-30172

Weight / Peso / Gewicht / Poids
3 Kg

Materials / Materiali / Materialien / Matériaux
BETALY®

Light hole / Foro luce / Bohrung / Trou lumière
20 x 150 mm

Light source / Sorgente luminosa / Lichtquelle / Source lumineuse
LED 4W

Tension / Tensione / Spannung / Tension
24Vdc

Remote constant voltage driver is required / Necessita di alimentatore remoto tensione costante
Benötigt externe Spannungsversorgung / Alimentateur à tension constante déporté nécessaire

Color temperature / Tonalità / Farbtemperatur / Température de couleur
3000°K

CRI
80

Lumen
400lm



1304B HINT

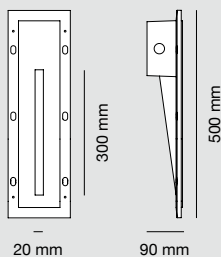

Article code / Codice articolo / Artikelnummer / Code de l'article
1304B-392-30172

Weight / Peso / Gewicht / Poids
3,9 Kg

Materials / Materiali / Materialien / Matériaux
BETALY®

Light hole / Foro luce / Bohrung / Trou lumière
20 x 300 mm

Light source / Sorgente luminosa / Lichtquelle / Source lumineuse
LED 4W

Tension / Tensione / Spannung / Tension
24Vdc

Remote constant voltage driver is required / Necessita di alimentatore remoto tensione costante
Benötigt externe Spannungsversorgung / Alimentateur à tension constante déporté nécessaire

Color temperature / Tonalità / Farbtemperatur / Température de couleur
3000°K

CRI
80

Lumen
400lm



1304C HINT BIG

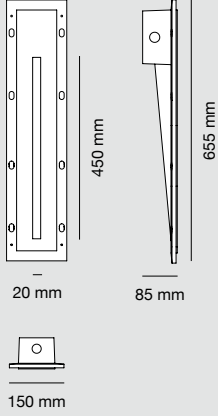

Article code / Codice articolo / Artikelnummer / Code de l'article
1304C-392-30172

Weight / Peso / Gewicht / Poids
6,7 Kg

Materials / Materiali / Materialien / Matériaux
BETALY®

Light hole / Foro luce / Bohrung / Trou lumière
20 x 450 mm

Light source / Sorgente luminosa / Lichtquelle / Source lumineuse
LED 4W

Tension / Tensione / Spannung / Tension
24Vdc

Remote constant voltage driver is required / Necessita di alimentatore remoto tensione costante
Benötigt externe Spannungsversorgung / Alimentateur à tension constante déporté nécessaire

Color temperature / Tonalità / Farbtemperatur / Température de couleur
3000°K

CRI
80

Lumen
400lm



Colors of the material / Colori del materiale / Farben der Materialien / Couleurs des matériaux

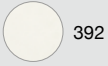

Accessories / Accessori / Zubehöre / Accessoires

Power supply code / Codice alimentatore / Netzgerät Code / Code driver	026.259	026.260	026.301
Power / Potenza / Leistung / Puissance	36W - 24Vdc	60W - 24Vdc	24W - 24Vdc
Protection degree / Grado di protezione / Schutzklasse / Degré de protection	IP20	IP20	IP20
Measurements / Misure / Abmessungen / Dimensions	169 x 57 x 19 mm	169 x 57 x 19 mm	164 x 38 x 25 mm
Dimming / Dimmerazione / Dimmung / Variateur de lumière	ON/OFF	ON/OFF	DIM PUSH / DALI / 0-10V / 1-10V
Input / ingresso / Eingang / Entrée	IN 220-240V~	IN 220-240V~	IN 220-240V~

PRODUCT INSTALLATION
POSA IN OPERA DEL PRODOTTO
INSTALLATION DER EINBAUPRODUKTE
INSTALLATION DES PRODUITS À ENCASTRER

EN 9010novantadeci's new line of recessed pathmarkers for outdoor environments are resistant to all weather conditions, and are suitable for illuminating any outside area, from your driveway to your porch, garden, or entrance. All our products' bodies are made of BETALY®, a high-performance cement-based material developed by 9010novantadeci, which is used in a variety of ways to create eco-friendly and non-toxic products, while guaranteeing durability and quality. The light body is directly integrated into the panels that make up the external insulation of the building's walls, also known as the insulating cladding. Once the light's position has been decided, work can begin. In this way, the cladding's insulating properties and the building's energy efficiency class are not affected. Before the product can be installed, flexible/corrugated tubes to provide electricity must be put in place. 9010novantadeci cladding insulation products can be inserted into regular 50 × 100 cm insulating blocks, made of ESP, mixed graphite etc. with a minimum thickness of 10 cm.

IT I segnapassi da incasso per l'ambiente esterno della nuova linea 9010 sono resistenti agli agenti atmosferici e adatti a illuminare qualsiasi luogo all'aria aperta, dal vialetto al portico, dal giardino all'ingresso. Il corpo di tutti i prodotti è realizzato in BETALY®, il materiale ultra performante a base cementizia sviluppato da 9010, che abbraccia diversi campi di applicazione creando prodotti eco-friendly e atossici, con alta garanzia di durata e qualità. Il corpo illuminante viene direttamente integrato nei pannelli che costituiscono l'isolamento esterno delle pareti dell'edificio, anche conosciuto con il nome di cappotto isolante. Una volta previsto il posizionamento dell'illuminazione è possibile proseguire con la costruzione. In questo modo si mantiene il grado di coibentazione del rivestimento e la classe di efficienza energetica della costruzione. Prima di installare il prodotto si rende necessaria la predisposizione dei tubi flessibili/corrugato per l'elettrificazione. I prodotti 9010 per cappotto possono essere inseriti nei comuni blocchi isolanti 50 × 100 cm di EPS, grafite misti, ecc., nello spessore minimo di 10 cm.

DE Die Einbau-Orientierungsleuchten für den Außenbereich der neuen Produktlinie 9010novantadeci halten der Witterung stand und eignen sich für die Beleuchtung aller Orte im Freien, vom Weg bis zur Veranda, vom Garten bis hin zum Eingang. Der Körper aller Produkte ist aus BETALY®, dem von 9010novantadeci entwickelten ultraleistungsfähigen Material auf Zementbasis, das für verschiedene Anwendungsbereiche geeignet ist und für die Fertigung von umweltfreundlichen, ungiftigen Produkten mit einer hohen Haltbarkeits- und Qualitätsgarantie verwendet wird. Der Leuchtkörper wird direkt in die Platten integriert, aus denen die auch als Wärmedämmverbundsystem bekannte Außendämmung der Gebäudefassaden besteht. Nach der Vorrichtung für die Positionierung der Beleuchtung kann mit dem Bau fortgesetzt werden. Auf diese Weise werden der Isolierwert der Verkleidung und die Energieeffizienzklasse des Gebäudes beibehalten. Vor der Installation des Produkts müssen Schläuche/Wellrohre für die Elektrifizierung gelegt werden. Die Produkte von 9010novantadeci für WDVS können in gewöhnliche 50 × 100 cm große Dämmplatten aus EPS, Graphit oder Mischungen usw. mit einer Mindestdicke von 10 cm eingefügt werden.

FR Les spots encastrés de jalonnement d'extérieur de la nouvelle ligne 9010novantadeci sont résistants aux intempéries et éclairent n'importe quel emplacement extérieur: l'allée, le porche, le jardin et l'entrée. Le corps de tous les produits est réalisé en BETALY®, un matériau à base de ciment à haute performance développé par 9010novantadeci, qui trouve son utilité dans différents domaines d'application, en créant des produits écologiques et non toxiques et à la garantie élevée de durabilité et de qualité. Le luminaire est directement intégré aux panneaux qui constituent l'isolation extérieure des murs du bâtiment, également appelée "mur manteau isolant". Une fois l'éclairage positionné, la construction peut être poursuivie. Cela permet de maintenir le niveau d'isolation du manteau et la classe d'efficacité énergétique de la construction. Avant d'installer le produit, il faut préparer les tuyaux flexibles/annelés pour l'électrification. Les produits 9010novantadeci pour le mur-manteau peuvent être insérés dans des blocs d'isolation communs de 50 × 100 cm en EPS, graphites mixtes, etc., sur une épaisseur minimale de 10 cm.



EN The wall installation height and pitch depend on the environment and the architectural scenario that you wish to create. If required insert rear insulation panel, recommended 10 mm 0.015 W/mK, not included.

IT L'altezza di installazione in parete ed il passo dipendono dall'ambiente e dallo scenario architettonico che si desidera riprodurre. Se richiesto inserire pannello isolante posteriore, consigliato 10 mm 0,015 W/mK, non incluso.

DE Die Installationshöhe an der Wand und der Abstand hängen von der Umgebung und dem architektonischen Szenario, das Sie gestalten möchten, ab. Bei Bedarf rückseitige Dämmplatte einsetzen, empfohlen 10 mm 0,015 W/mK, nicht im Lieferumfang enthalten.

FR La hauteur de l'installation murale et l'entraxe dépendent de l'environnement et du style architectural à reproduire. Si nécessaire, insérer le panneau d'isolation arrière, recommandé 10 mm 0,015 W/mK, non inclus.

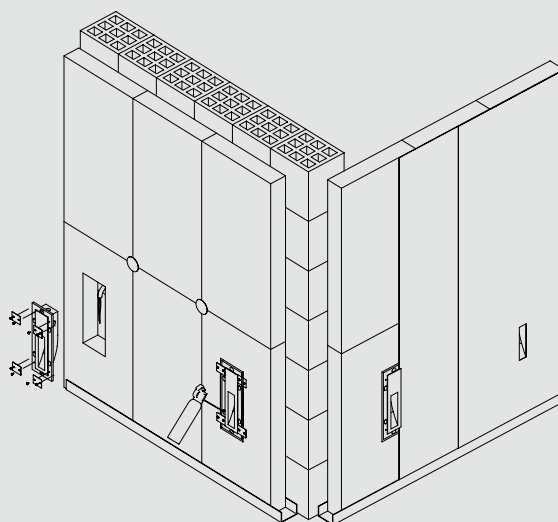

1

EN Cut the insulation panels to size in order to create a space in which to fit the product.

IT Taglio a misura dei pannelli di coibentazione per ricavare lo spazio per l'inserimento del prodotto.

DE Zuschnitt der Dämmplatten, um den nötigen Raum für das Einsetzen des Produkts zu gewinnen.

FR Découpe sur mesure des panneaux d'isolation pour créer l'espace nécessaire à l'insertion du produit.

2

EN Position and fix with polyurethane foam.

IT Posizionamento e fissaggio con schiuma poliuretanaica.

DE Positionierung und Fixierung mit Polyurethanschaum.

FR Positionnement et fixation avec de la mousse de polyuréthane.

3

EN Carry out an initial laevelling and apply the overlapping mesh along the perimeter joint.

IT Prima rasatura e applicazione della rete di sormonto lungo la giuntura perimetrale.

DE Erster Ausgleichsputz und Anbringung des Armierungsgewebes entlang des Verbindungsumfangs.

FR Premier ragréage et application d'une bande de recouvrement le long du joint périphérique.

4

EN Finish the facade and paint. Connect the light to the electricity supply.

IT Rasatura di finitura della facciata e tinteggiatura. Collegamento elettrico del corpo illuminante.

DE Endgültiger Ausgleichsputz der Fassade und Streichen. Elektrischer Anschluss des Leuchtkörpers.

FR Lissage de finition de la façade et peinture. Raccordement électrique du luminaire.

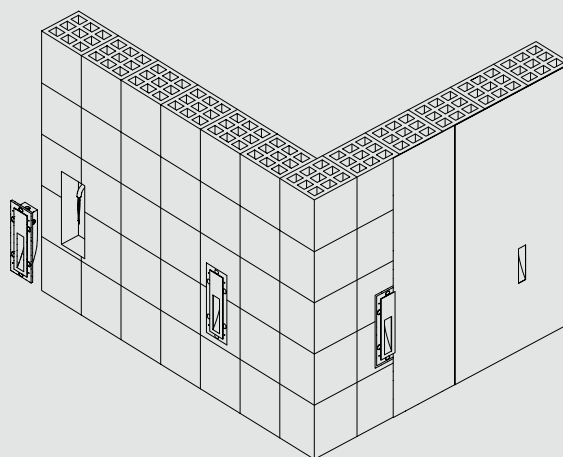

1

EN Create the required space in the brickwork in order to fit the product.

IT Ricavo nel laterizio dello spazio necessario per l'inserimento del prodotto.

DE Schaffung des notwendigen Raums für das Einsetzen des Produkts im Ziegel.

FR Encastrement dans la maçonnerie de l'espace nécessaire à l'insertion du produit.

2

EN Position and fix with polyurethane foam and/or cementitious grouts.

IT Posizionamento e fissaggio con schiuma poliuretanaica e/o malta cementizia.

DE Positionierung und Fixierung mit Polyurethanschaum und/oder Zementmörtel.

FR Positionnement et fixation avec de la mousse de polyuréthane et/ou du mortier de ciment.

3

EN Carry out an initial laevelling and apply the overlapping mesh along the perimeter joint.

IT Prima rasatura e applicazione della rete di sormonto lungo la giuntura perimetrale.

DE Erster Ausgleichsputz und Anbringung des Armierungsgewebes entlang des Verbindungsumfangs.

FR Premier ragréage et application d'une bande de recouvrement le long du joint périphérique.

4

EN Finish the facade and paint. Connect the light to the electricity supply.

IT Rasatura di finitura della facciata e tinteggiatura. Collegamento elettrico del corpo illuminante.

DE Endgültiger Ausgleichsputz der Fassade und Streichen. Elektrischer Anschluss des Leuchtkörpers.

FR Lissage de finition de la façade et peinture. Raccordement électrique du luminaire.

HOUSE NUMBERS AND LETTERS
NUMERI CIVICI E LETTERE
HAUSNUMMERN UND BUCHSTABEN
NUMÉROS DE RUE ET LETTRES



N0-9 A-D

Designed by 9010novantadiecì

EN An infinity of combinations - from 0 to 9, from A to D. These numbers and letters can be combined or used singularly, making your house-number a stylish welcome your home. Made entirely of BETALY®, they completely encapsulate the artisanal approach of 9010novantadiecì.

IT Da 0 a 9, da A a D per comporre infinite combinazioni. I numeri e le lettere, abbinati o da soli, possono essere apposti sui civici delle nostre abitazioni, e rappresentarne il biglietto da visita. Realizzati totalmente in BETALY®, riassumono a pieno l'approccio artigianale di 9010.

DE Von 0 bis 9, von A bis D, um unendliche Kombinationen zu schaffen. Die Zahlen und Buchstaben können gemeinsam oder alleine als Hausnummer unser Wohnungen angebracht werden und als ihre Visitenkarte fungieren. Sie sind komplett aus BETALY® gefertigt und bringen den handwerklichen Ansatz von 9010novantadiecì perfekt auf den Punkt.

FR De 0 à 9, de A à D pour composer des combinaisons à l'infini. Les chiffres et les lettres, combinés ou non, peuvent être apposés sur les numéros de rue de nos maisons, et représentent une carte de visite. Réalisés entièrement en BETALY®, ils racontent parfaitement l'approche artisanale de 9010novantadiecì.

House numbers and letters
Numeri civici e lettere
Hausnummern und Buchstaben
Numéros de rue et lettres

Art.
N0-9 / A-D

9010novantadiecì Outdoor



Art. N3-395 + N8-395



Art. N2-393 + N4-396 + A-395

Art. N9-394 + N4-393



N0-392*

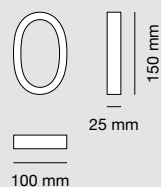

Materials / Materiali / Materialien / Matériaux
BETALY®



N1-392*

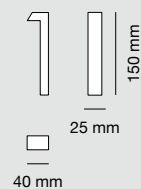

Materials / Materiali / Materialien / Matériaux
BETALY®



N2-392*

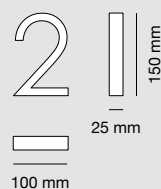

Materials / Materiali / Materialien / Matériaux
BETALY®



N3-392*

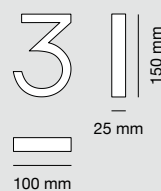

Materials / Materiali / Materialien / Matériaux
BETALY®



N4-392*

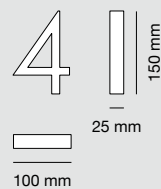

Materials / Materiali / Materialien / Matériaux
BETALY®



N5-392*

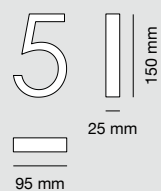

Materials / Materiali / Materialien / Matériaux
BETALY®



N6-392*

Materials / Materiali / Materialien / Matériaux
BETALY®

CE

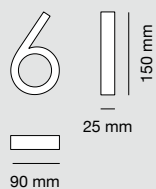

N7-392*

Materials / Materiali / Materialien / Matériaux
BETALY®

CE

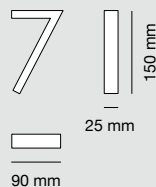

N8-392*

Materials / Materiali / Materialien / Matériaux
BETALY®

CE

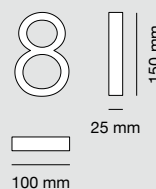

N9-392*

Materials / Materiali / Materialien / Matériaux
BETALY®

CE

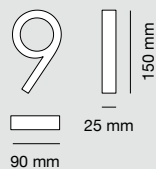

A-392*

NEW

Materials / Materiali / Materialien / Matériaux
BETALY®

CE

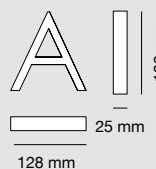

B-392*

NEW

Materials / Materiali / Materialien / Matériaux
BETALY®

CE

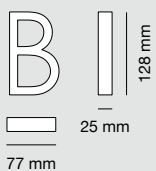

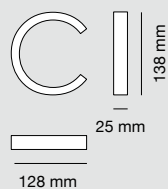

Materials / Materiali / Materialien / Matériaux
BETALY®

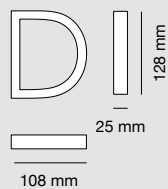

Materials / Materiali / Materialien / Matériaux
BETALY®



*Colors of the material / Colori del materiale / Farben der Materialien / Couleurs des matériaux



On request available in white dyeable color / Disponibile su richiesta in finitura bianca colorabile
Auf Anfrage in weißer einfärbbarer Farbe erhältlich / Sur demande disponible en couleur blanche teintable

ACCESSORIES
ACCESSORI
ZUBEHÖRE
ACCESSOIRES





Art. 1103B-395-3012 + 1103K-395

Art. 1103B-395-3012 + 1103K-395



1103K-396*

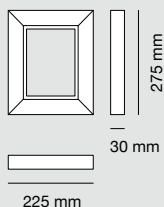

Materials / Materiali / Materialien / Matériaux
BETALY®

Cover-base / Copri base / Sockel / Couverture de la base
1103A - 1103B



1105K-396*

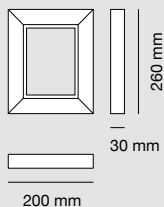

Materials / Materiali / Materialien / Matériaux
BETALY®

Cover-base / Copri base / Sockel / Couverture de la base
1105B - 1105C



1106K-396*

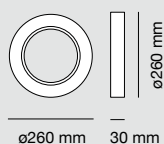

Materials / Materiali / Materialien / Matériaux
BETALY®

Cover-base / Copri base / Sockel / Couverture de la base
1106A



1110K-396*



Materials / Materiali / Materialien / Matériaux
BETALY®

Cover-base / Copri base / Sockel / Couverture de la base
1110A - 1110B



*Colors of the material / Colori del materiale / Farben der Materialien / Couleurs des matériaux



On request available in white dyeable color / Disponibile su richiesta in finitura bianca colorabile
Auf Anfrage in weißer einfärbbarer Farbe erhältlich / Sur demande disponible en couleur blanche teintable

MATERIALS BETALY®

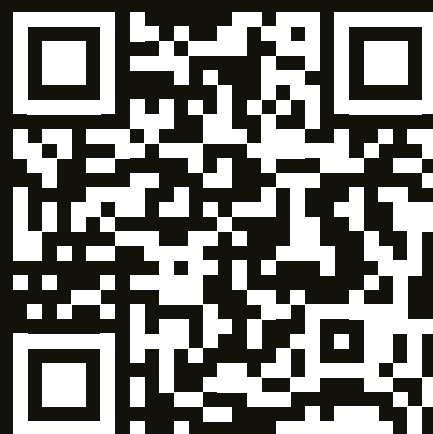

EN 9010novantadiecì takes the richness of an artisan past and turns it into a vessel for something completely new: a high-performance material suitable for outdoor spaces. Nature gives us a raw material that's tangibly practical and can be used for any type of outdoor space. It combines material strength and lightness of form, versatility and characterful design. BETALY® by 9010novantadiecì is a compound that makes every item unique, thanks to its distinctive artisan finish. The surface of every item is and must be unrepeatable, because its superior quality lies in its exceptional singularity. This is an important new material with an artisan boldness which immediately customises a space and allows the user to enjoy the distinctive sinuousness of shapes conceived by the 9010novantadiecì designers.

IT 9010 porta con sé la ricchezza di un passato artigianale e ne fa un contenitore per qualcosa di assolutamente nuovo: un materiale altamente performante adatto ad ambienti esterni. Dalla natura proviene una materia prima dalla concretezza tangibile e adatta a qualsiasi tipo di ambiente esterno. In esso coesistono forza del materiale e leggerezza delle forme, versatilità e design di carattere. Il BETALY® di 9010 è un composto che rende ogni pezzo unico, grazie alla lavorazione artigianale che ci contraddistingue. La superficie di ogni pezzo sarà e deve essere irripetibile, poiché è nella sua eccezionale peculiarità che risiede la sua superiorità. Un materiale nuovo ed importante, dalla verve artigianale, che personalizza subito l'ambiente e che permette al fruitore di godere della sinuosità tipica delle figure ideate dai designer 9010.

DE 9010novantadieci bringt den Reichtum einer handwerklichen Vergangenheit mit sich und macht daraus ein Gefäß für etwas vollkommen Neues: ein leistungsstarkes Material, das für den Außenbereich geeignet ist. Aus der Natur stammt ein Rohstoff mit greifbarer Substanz, der für jeden Außenbereich geeignet ist. In ihm koexistieren Stärke des Materials und Leichtigkeit der Formen, Vielseitigkeit und Design mit Charakter. BETALY® von 9010novantadieci ist eine Verbindung, die dank der handwerklichen Verarbeitung, die uns auszeichnet, jedes Stück einzigartig macht. Die Oberfläche jedes Stücks wird und muss ohnegleichen sein, da seine Überlegenheit in seiner außergewöhnlichen Besonderheit liegt. Ein neues und wichtiges Material mit handwerklichem Schwung, das der Umgebung sofort eine persönliche Note gibt und es dem Benutzer ermöglicht, die typischen Kurven der Figuren zu genießen, die von den Designern 9010novantadieci kreiert wurden.

FR 9010novantadieci, c'est la richesse d'un passé artisanal qui devient un support pour une absolue nouveauté: un matériau à hautes performances adapté aux environnements extérieurs. La nature fournit une matière première vraiment tangible, adaptée à tout type d'environnement extérieur. La force du matériau côtoie la légèreté des formes, l'universalité se double d'un design de caractère. Le BETALY® de 9010novantadieci est un composé qui rend chaque pièce unique, grâce au travail artisanal qui nous distingue. La surface de chaque pièce sera et doit être inimitable, car c'est dans son exceptionnelle particularité que réside sa supériorité. Un matériau nouveau et important, à la verve artisanale, qui donne immédiatement du caractère au lieu et qui permet d'apprécier les rondeurs typiques des formes imaginées par les designers 9010novantadieci.



EN Products created using BETALY® have excellent resistance to wear and extremely high levels of resistance to compression and atmospheric agents. They are also waterproof and suitable for use in outdoor areas, thanks to IP65 protection for electrical components. BETALY® has a rough, textured surface which evokes nature and its primitive, essential shapes; a material that can adapt to exteriors and add an impactful designer touch.

IT I prodotti creati con BETALY® hanno un'eccellente resistenza all'usura, con un'altissima resistenza alla compressione e agli agenti atmosferici. Sono inoltre impermeabili ed adatti ad essere applicati in zone esterne, grazie alla parte elettrica con grado di protezione IP65. BETALY® ha una superficie grezza e concreta che ricorda la natura, così come le sue forme essenziali e primitive, è un elemento in grado di adattarsi agli spazi esterni dando un accento di design d'impatto.

DE Die mit BETALY® hergestellten Produkte weisen eine ausgezeichnete Verschleißfestigkeit mit höchster Beständigkeit gegen Druck- und Witterungseinflüsse auf. Darüber hinaus sind sie wasserdicht und dank dem elektrischen Teil mit Schutzgrad IP65 für die Verwendung in Außenbereichen geeignet. BETALY® hat eine rohe und konkrete Oberfläche, die an die Natur erinnert, so wie seine essentiellen und primitiven Formen. Es ist ein Element, das sich den Außenräumen anpassen kann und einen wirkungsvollen Designakzent schafft.

FR Les produits créés avec BETALY® sont extraordinairement résistants à l'usure, avec une très haute résistance à la compression et aux agents atmosphériques. Ils sont de plus imperméables et peuvent être installés à l'extérieur grâce à leur partie électrique à indice de protection IP65. BETALY® présente une surface brute et concrète qui rappelle la nature, tout comme ses formes essentielles et primitives, il s'agit d'un élément qui sait s'adapter aux espaces extérieurs en apportant une touche de design du plus grand effet.



Suitable for outdoor use
Adatto per ambienti esterni
Geeignet für Outdoor
Adapté pour l'extérieur



Frost resistant
Resistente al gelo
Frostbeständig
Résistant au gel



Thermal resistant
Resistenza termica
Thermische Beständigkeit
Résistance thermique



Non flammable
Non infiammabile
Nicht entflammbar
Non inflammable



High Impact resistance
Alta resistenza agli urti
Hohe Schlagbeständigkeit
Haute résistance aux chocs



Materic touch
Tocco materico
Materialeffekt
Touche Matière



Non-toxic
Atossico
Nicht toxisch
Non toxiques



Non deforming
Assenza di deformazione
Keine Deformation
Absence de déformation



Absence of chemical reaction
Assenza di reazioni chimiche
Ohne chemische Reaktion
Absence de réactions chimiques



UV resistant
Resistenza ai raggi UV
UV-Beständigkeit
Résistant aux rayons UV



Salt corrosion resistant
Resistenza alla salinità
Salzkorrosionsbeständig
Résistant aux agressions salines



Abrasion resistant
Resistente all'abrasione
Abriebbeständig
Résistant à l'abrasion

BETALY® COLORS

EN The range of colors take their inspiration from nature, in the shades and details of the surfaces, calling upon the earth and the sap and the leaves, as unique nuances that come together in sinuous forms to create luminous elements of great impact and emotion. Thanks to the natural components and the entire artisanal realisation, BETALY® presents – from its very creation and as it develops throughout its life – an efflorescences that confers a unique characteristic and exclusive and unrepeatable shades of color.

IT La gamma di che prendono la loro ispirazione dalla natura, nelle tonalità e nei dettagli delle superfici, ricordando la terra e la linfa e le foglie, nuances uniche che si uniscono a forme sinuose per creare elementi luminosi di impatto ed emozione. BETALY® per i suoi componenti naturali e per la realizzazione completamente artigianale presenta sin dalla nascita, che poi si sviluppano durante tutta la sua vita, delle efflorescenze che sono una peculiarità e che donano esclusive ed irripetibili sfumature di colore.

DE Die Farbpalette ist in den Schattierungen und Details der Oberflächen von der Natur inspiriert und erinnert an die Erde, den Saft und die Blätter als einzigartige Nuancen, die sich in geschwungenen Formen vereinen, um leuchtende Elemente von großer Wirkung und Emotion zu schaffen. Dank der natürlichen Bestandteile und der vollständig handwerklichen Verarbeitung präsentiert BETALY® – von seiner Entstehung an und während seiner Entwicklung im Laufe seines Lebens – eine Ausblühung, die ihm eine einzigartige Charakteristik und exklusive und unwiederholbare Farbnuancen verleiht.

FR La gamme de couleurs s'inspire de la nature, dans les nuances et les détails des surfaces, faisant appel à la terre, à la sève et aux feuilles, comme des nuances uniques qui s'unissent dans des formes sinueuses pour créer des éléments lumineux de grand impact et d'émotion. Grâce aux composants naturels et à la réalisation entièrement artisanale, BETALY® présente - dès sa création et au fur et à mesure qu'il se développe tout au long de sa vie - des efflorescences qui confèrent une caractéristique unique et des nuances de couleur exclusives et irremplaçables.





Color range example (395)
Esempio gamma di colore (395)
Beispiel Farbbereich (395)
Exemple de gamme de couleurs (395)

392



393



394



395



396



397



DESIGNERS

TOMMASO ANDOLFATTO

ALICE BARKI

PAOLO D'ARRIGO

DANILO DE ROSSI

GIACOMO EDI

FORMIDABLE STUDIO

KALIN GEMIGNANI

ALBERTO GHIRARDELLO

HENRY & CO.

LUCIANO MICHELE LETTIERI

MAURIZIO QUARGNALE

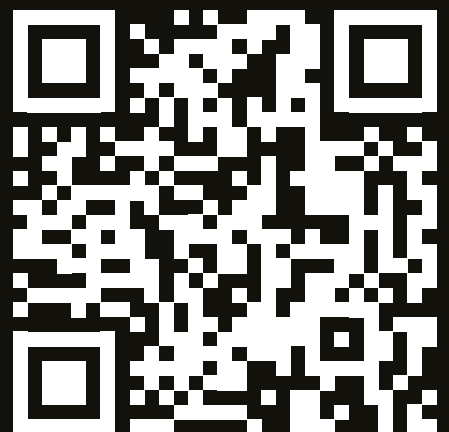

EN An innovative collection characterised by design and excellent quality; a close focus on current trends and attention to detail. Our production methods guarantee resistance and robustness while retaining artisan quality, allowing us to create items that are unique and unrepeatable. The perfect solution for terraces, walkways, gardens and any outside space that needs lighting. Thanks to our successful collaborations with renowned design creatives, 9010novantadiecì has developed a series of products that illuminate and astonish. Illuminate with our creativity and our tradition, a half-century history of a firm where Made in Italy has become a trademark. Astonish with our heart and our passion, ever-present in shapes and lighting creations that build our philosophy.

IT Una collezione innovativa caratterizzata da design e alta qualità, grande attenzione alle tendenze e cura dei dettagli. Un metodo produttivo che garantisce resistenza e solidità ma pur sempre artigianale, permettendo di realizzare prodotti irripetibili ed unici. Una soluzione ideale per terrazze, vialetti, giardini, ed ogni ambiente esterno da illuminare. Grazie alle riuscite collaborazioni con spiccate personalità creative del design, 9010 ha confezionato una serie di prodotti capaci di illuminare e di stupire. Illuminare dalla nostra mente con tradizione, con mezzo secolo di storia di un'azienda che ha fatto del Made in Italy il suo marchio di fabbrica. Stupire dal nostro cuore con passione, quella che non ci manca mai, con forme e creazioni di luce che compongono la nostra filosofia.

DE Eine durch Design und hoher Qualität gekennzeichnete innovative Kollektion mit großem Augenmerk auf Trends und Liebe zum Detail. Eine Produktionsmethode, die Beständigkeit und Solidität gewährleistet, aber dennoch handwerklich ist, und einmalige und einzigartige Produkte schafft. Eine ideale Lösung für Terrassen, Wege, Gärten und alle Außenbereiche, die zu beleuchten sind. Dank der erfolgreichen Zusammenarbeit mit unverkennbaren kreativen Persönlichkeiten des Designs hat 9010novantadiecì eine Reihe von Produkten entwickelt, die beleuchten und in Erstaunen versetzen können. Unseren Geist mit Tradition erleuchten, mit einem halben Jahrhundert Unternehmensgeschichte, die das Made in Italy zu seinem Markenzeichen gemacht hat. Aus unserem Herzen mit Leidenschaft erstaunen, die uns nie fehlt, mit Formen und Lichtkreationen, die unsere Philosophie ausmachen.

FR Une collection innovante dont les caractéristiques sont le design et la haute qualité, une grande attention aux tendances et le soin du détail. Une méthode de fabrication qui garantit résistance et solidité mais qui reste artisanale, permettant de réaliser des produits inimitables et uniques. Une solution idéale pour les terrasses, allées, jardins et tout espace extérieur à éclairer. Grâce à d'heureuses collaborations avec d'émérites personnalités créatives du design, 9010novantadiecì a réalisé une série de produits d'éclairage stupéfiants. Éclairer par notre créativité avec tradition, une histoire d'un demi-siècle d'une entreprise qui a fait du Made in Italy sa marque de fabrique. Stupéfier par notre cœur avec passion, toujours au rendez-vous, avec des formes et des créations de lumière qui font notre philosophie.



1117 VIMA

P.116

EN Tommaso was born in 1987, and graduated in industrial design. He has worked in various industrial sectors since 2015, acquiring skills in different production techniques alongside established designers such as Matteo Ragni in Milan and Tomek Rygalyk in Warsaw. Since 2018 he has been working as a designer in the lighting, sports product, and furniture field. In 2020 he founded Porporahandmade, a company that recycles local wood, transforming it into designer objects. His approach is "materials driven": the material is the protagonist; it must be respected, not only in terms of its correct use, but also by recycling it.

IT Classe 1987, si laurea in Design Industriale. Lavora dal 2015 in diversi settori industriali acquisendo competenze in varie tecniche di produzione, al fianco di affermati designer come Matteo Ragni a Milano e Tomek Rygalyk a Varsavia. Dal 2018 si occupa di design e progettazione nell'ambito dell'illuminazione, di articoli sportivi e arredo. Nel 2020 fonda Porporahandmade, brand che ricicla il legno locale per trasformarlo in oggetti di design. Il suo approccio è "materials driven": il materiale è il protagonista, va rispettato, in vista del suo corretto utilizzo e soprattutto riciclo.

DE Jahrgang 1987, Universitätsabschluss in Industriedesign. Er arbeitet seit 2015 in verschiedenen Branchen und erwirbt dabei Kompetenzen in verschiedenen Produktionstechniken an der Seite etablierter Designer wie Matteo Ragni in Mailand und Tomek Rygalyk in Warschau. Seit 2018 beschäftigt er sich mit Design und Planung im Bereich Beleuchtung, Sportartikel und Einrichtung. 2020 gründet er Porporahandmade, eine Marke, die lokales Holz wiederverwertet, um es in Designobjekte zu verwandeln. Sein Ansatz ist "materials driven": Das Material steht im Mittelpunkt, es muss in Hinblick auf seine korrekte Verwendung und vor allem seine korrekte Wiederverwertung respektiert werden.

FR Né en 1987, il est diplômé en design industriel. Il travaille depuis 2015 dans différentes industries en acquérant des compétences dans diverses techniques de production, aux côtés de designers établis tels que Matteo Ragni à Milan et Tomek Rygalyk à Varsovie. Depuis 2018, il s'occupe du design et de la conception dans les domaines de l'éclairage, des articles de sport et du mobilier. En 2020, il fonde Porporahandmade, une marque qui recycle le bois local et le transforme en objets design. Son approche est "axée sur les matériaux": le matériau est le protagoniste, il doit être respecté, en vue de sa bonne utilisation et surtout de son recyclage.



1121 ANTHEA	P.200
-------------	-------

1205 KERIS	P.74
------------	------

EN Alice Barki believes that designs should be born through careful observation of the world that surrounds us. She is an all-round designer who creates complex shapes resulting from inspiration drawn from analysing nature, the environment, and the forms that surround it. Working from her studio in Milan, Barki is a product and interior design professor at three Milan universities; a professional career that is completed by passionately and dedicatedly alternating collaborations, consultancy, and participation in design world events.

IT Alice Barki è una Designer che crede che i progetti debbano nascere da un'attenta osservazione del mondo circostante. I suoi lavori sono a 360°, crea forme complesse frutto dell'ispirazione che trae da un'analisi della natura, dell'ambiente e delle forme che la circondano. Ha lo Studio a Milano, docente di Product e Interior Design in tre Università milanesi, completa il suo percorso professionale alternando collaborazioni, consulenze e partecipando ad eventi legati al mondo del Design con passione e dedizione.

DE Alice Barki ist eine Designerin, die daran glaubt, dass die Projekte durch eine aufmerksame Betrachtung der Welt, die uns umgibt, entstehen müssen. Ihre Arbeiten decken ein 360°-Spektrum ab, sie schafft komplexe Formen, die das Ergebnis der Inspiration sind, die sie sich durch die Untersuchung der Natur, der Umwelt und der Formen, von denen sie umgeben ist, holt. Ihr Studio ist in Mailand und sie unterrichtet Produkt- und Innendesign an drei Mailänder Universitäten. Zur Vollendung ihrer beruflichen Laufbahn wechselt sie Zusammenarbeiten, Beratungen und die Teilnahme an Veranstaltungen in der Welt des Designs mit großer Leidenschaft und Hingabe ab.

FR Alice Barki est designer et pense que les projets doivent naître d'une observation attentive du monde qui l'entoure. Son travail est complet: elle crée des formes complexes en s'inspirant de son analyse de la nature, de l'environnement et des formes qui l'entourent. Son cabinet est à Milan. Elle enseigne le design de produit et d'intérieur dans trois universités milanaises et complète sa carrière professionnelle en alternant collaborations, consultations et participation à des événements liés au monde du design avec passion et dévouement.



1102 SER	P.96
1103A MONO	P.144
1103B DOUBLE	P.144
1103B DOUBLE SMALL	P.144
1107 COBRA	P.164

EN Paolo D'Arrigo is a designer who approaches his projects as an alchemy of nature and hi-tech, in which shape is the result of a process that challenges the limits of material and goes beyond them. An active member of several associations, he has chaired the ADI Lazio delegation and the In Forma Azione association. He teaches Industrial Design to students at La Sapienza University in Rome. He is the recipient of numerous awards in Italy and abroad, including the German Design Award and three times the ADI Design Index.

IT Paolo D'Arrigo è un designer che vive il progetto come un'alchimia di natura e hi-tech dove la forma è l'esito di un processo che si misura con i vincoli della materia e li spinge oltre. Attivo nell'associazionismo, ha presieduto la delegazione ADI Lazio e l'associazione In Forma Azione. Insegna Design industriale agli allievi de La Sapienza di Roma. Ha ottenuto numerosi riconoscimenti e premi in Italia e all'estero, tra i quali il German Design Awards e tre ADI Design Index.

DE Paolo D'Arrigo ist ein Designer, der das Projekt als eine Alchemie aus Natur und Hi-Tech lebt, in der die Form das Ergebnis eines Vorgangs ist, der an den Einschränkungen der Materie gemessen wird und sie weitertreibt. In Verbänden aktiv, leitete er die Delegation ADI Lazio und den Verband In Forma Azione. Er unterrichtet Industriedesign an der Universität La Sapienza in Rom. Er hat zahlreiche Auszeichnungen und Preise in Italien und im Ausland erhalten, darunter der German Design Award und drei ADI Design Index.

FR Paolo D'Arrigo est un designer qui vit le projet à la manière d'une alchimie de nature et de haute technologie, où la forme est le dénouement d'un processus qui se mesure aux contraintes de la matière et les pousse au-delà. Actif dans le milieu des associations, il a été Président de la délégation ADI Latium et de l'association In Forma Azione. Il enseigne le Design industriel aux étudiants de La Sapienza, à Rome. Il a obtenu de nombreux prix et récompenses en Italie et dans le monde, dont le German Design Awards et trois ADI Design Index.



1116A ALFIERE SMALL	P.112
---------------------	-------

1116B ALFIERE	P.194
---------------	-------

EN This Tuscan designer was born in 1991 and graduated in industrial design from the faculty of architecture in Florence. He has collaborated with several important studios where he experimented with the design process in its entirety. After launching his career in Florence, Giacomo moved to Milan in order to concentrate on the product design of furnishing accessories. His approach begins by looking to the past, then embarking on an endless search through different worlds for inspiration and intuition, with attention to detail and a balance between function and aesthetics.

IT Designer toscano classe 1991, si laurea in disegno industriale alla facoltà di architettura di Firenze. Durante il suo percorso collabora con importanti studi professionali sperimentando il processo progettuale nella sua totalità. Lavora prima a Firenze e successivamente a Milano, dove si sposta per concentrarsi nell'ambito del Product Design di complementi d'arredo. Il suo approccio muove da uno sguardo al passato e volge alla continua ricerca di ispirazioni e intuizioni che arrivano da mondi diversi, con attenzione ai dettagli e all'equilibrio tra funzione ed estetica.

DE Dieser Designer aus der Toskana aus dem Jahrgang 1991 schließt sein Industriedesignstudium an der Architekturfakultät in Florenz ab. Im Lauf seines Werdegangs arbeitet er mit bedeutenden professionellen Studios zusammen, wobei er den Planungsprozess von A bis Z erlebt. Er arbeitet zuerst in Florenz und dann in Mailand, wo er sein Gebiet wechselt und sich auf den Bereich des Produktdesigns von Einrichtungsgegenständen konzentriert. Sein Ansatz geht von einem Blick auf die Vergangenheit aus und wendet sich hin zur ständigen Suche nach Inspirationen und Intuitionen, die aus verschiedenen Welten stammen, mit Detailliebe und Gleichgewicht zwischen Funktion und Ästhetik.

FR Designer toscano né en 1991, il se diplôme en design industriel de la faculté d'architecture de Florence. Au cours de sa carrière, il collabore avec d'importants cabinets professionnels, expérimentant le processus de conception dans son intégralité. Il travaille d'abord à Florence, puis à Milan, où il se concentre sur le design de produits d'accessoires d'ameublement. Son approche est basée sur un regard vers le passé et se tourne vers la recherche continue d'inspirations et d'intuitions provenant de différents mondes, avec une attention particulière aux détails et à l'équilibre entre la fonction et l'esthétique.



1120 CHARTA

P.126

EN De Rossi has been an architect and designer since 1983, and obtained a specialisation in lighting design from the Milan Polytechnic in 1985. He is art director for the brands Leucos, De Majo Murano, and Italamp, where he is responsible for developing product and communication aesthetics, as well as that of their trade fair spaces and show rooms. For the brands themselves he designs internationally renowned lamp collections. He teaches product design and lighting design at the Raffles RM Institute in Milan.

IT Svolge la professione di architetto e designer dal 1983, con specializzazione in progettazione illuminotecnica conseguita al Politecnico di Milano nel 1985. Ricopre il ruolo di Art Director per i marchi Leucos, De Majo Murano e Italamp, per i quali sviluppa le linee artistiche di prodotto e della comunicazione e cura gli ambiti espositivi nelle fiere e show rooms. Per i marchi stessi disegna collezioni di lampade che ottengono riconoscimenti internazionali. È docente di Product Design e Lighting Design presso l'Istituto Raffles RM di Milano.

DE Den Beruf des Architekten und Designers übt er seit 1983 aus, 1985 schloss er sein Studium an der Mailänder technischen Hochschule Politecnico in seinem Spezialgebiet, der Beleuchtungsplanung, ab. Er arbeitet als Art Director für die Marken Leucos, De Majo Murano und Italamp, für die er die künstlerischen Produkt- und Kommunikationslinien entwickelt und die Ausstellungsbereiche auf Messen und in Showrooms gestaltet. Für diese Marken entwirft er auch Lampenkollektionen, die internationale Anerkennungen erzielen. Er unterrichtet Product Design und Lighting Design am Institut Raffles RM in Mailand.

FR Il travaille comme architecte et designer depuis 1983 et s'est spécialisé dans la conception d'éclairage à l'école polytechnique de Milan en 1985. Il occupe le poste de directeur artistique pour les marques Leucos, De Majo Murano et Italamp, pour lesquelles il développe les lignes artistiques de produit et de communication et s'occupe des espaces d'exposition dans les salons et les showrooms. Pour les marques elles-mêmes, il conçoit des collections de lampes qui obtiennent une reconnaissance internationale. Il est professeur en conception de produits et d'éclairage à l'Institut Raffles RM de Milan.



1109 ERCOLE

P.176

EN The collaboration between interior designer Giulia Ciccarese (born 1988) and architect Devis Busato (born 1981), who both studied at the IUAV in Venice, dates back to 2014. Creativity, research and multiple disciplines are the starting point for their professional journey in the fields of design and architecture. The same year they created the Formidable project - an acronym for form, identity and ability, but also literally "marvellous", as the creative process that characterises their profession.

IT La collaborazione tra l'interior designer Giulia Ciccarese (1988) e l'architetto Devis Busato (1981), laureati presso lo IUAV di Venezia, nasce nel 2014. Creatività, ricerca e multidisciplinarietà sono il punto di partenza del loro percorso progettuale e professionale nel campo del design e della progettazione architettonica. Lo stesso anno danno vita al progetto Formidable, acronimo di forma, identità e potenzialità, ma anche, letteralmente, "meraviglioso" come il processo creativo che caratterizza la loro professione.

DE Die Zusammenarbeit zwischen der Innenarchitektin Giulia Ciccarese (1988) und dem Architekten Devis Busato (1981), der an der IUAV in Venedig studiert hat, wird 2014 geboren. Kreativität, Forschung und Multidisziplinarität sind die Ausgangspunkte ihrer Gestaltung und beruflicher Laufbahn im Bereich Design und Architekturdesign. Im selben Jahr entsteht das Projekt Formidable, ein Akronym für Form, Identität und Potenzial, aber auch wortwörtlich "wunderbar", wie der kreative Prozess, der ihren Beruf kennzeichnet.

FR La collaboration entre l'architecte d'intérieur Giulia Ciccarese (1988) et l'architecte Devis Busato (1981), diplômés à IUAV de Venise, date de 2014. Créativité, recherche et multidisciplinarité sont les points de départ de leur parcours de conception et professionnels dans le design et l'architecture. La même année, ils créent le projet Formidable, acronyme de forme, identité et potentialité, mais qui signifie aussi, littéralement, "merveilleux", comme le processus créatif qui caractérise leur métier.



1108A ZETA SMALL

P.168

1108B ZETA

P.168

EN Kalin Gemignani is a Lucca-based architect, born in Bulgaria. Following several years' experience in a designer lighting firm, in 2018 he opened his own architecture and product design studio. In 2019 he attended the Salone Satellite in Milan, where his collaboration with 9010novantadieci began.

IT Architetto lucchese, nato in Bulgaria. Dopo alcuni anni di esperienza in un'azienda nel settore dell'illuminazione di design, nel 2018 apre il proprio studio di progettazione architettonica e del prodotto. Presente al Salone Satellite di Milano nel 2019 dove nasce la collaborazione con 9010.

DE Architekt aus Lucca, geboren in Bulgarien. Nach einigen Jahren Erfahrung in einem Unternehmen im Bereich der Designbeleuchtung hat er 2018 sein eigenes Studio für architektonisches Design und Produktdesign eröffnet. Während seiner Teilnahme am Salone Satellite in Mailand im Jahr 2019 wird die Zusammenarbeit mit 9010novantadieci geboren.

FR Architecte de Lucques, né en Bulgarie. Après quelques années d'expérience dans une entreprise du secteur de l'éclairage design, en 2018 il ouvre son propre cabinet d'architecture et de conception de produits. Il est présent au Salon Satellite de Milan en 2019 où s'instaure la collaboration avec 9010novantadieci.



1104 DOMINO	P.64
1105A BEAN SMALL	P.102
1105B BEAN	P.152
1105C BEAN BIG	P.152
1106A MINÙ	P.158

EN Alberto Ghirardello is a Vicenza-born product designer who currently lives and works in Milan, where he gained several years' experience in several professional design studios and in 2013 founded his own studio, focusing on every aspect of design and collaborating with a number of firms and institutes both in Italy and abroad.

IT Alberto Ghirardello è un product designer originario di Vicenza che attualmente vive e lavora a Milano dove ha maturato alcuni anni di esperienza all'interno di diversi studi professionali e nel 2013 fonda il proprio studio di progettazione, occupandosi di design a 360° e collaborando con numerose aziende ed istituzioni, sia italiane che estere.

DE Alberto Ghirardello ist ein Produktdesigner aus Vicenza, der derzeit in Mailand lebt und arbeitet, wo er einige Jahre Erfahrung in verschiedenen professionellen Studios gesammelt hat und im Jahr 2013 sein eigenes Designstudio gegründet hat, sich um 360° mit Design beschäftigt und mit zahlreichen Unternehmen und Institutionen im In- und Ausland zusammenarbeitet.

FR Alberto Ghirardello est un product designer originaire de Vicence, actuellement il vit et travaille à Milan où il s'est forgé quelques années d'expérience au sein de divers cabinets professionnels; en 2013 il fonde son propre bureau de conception en se chargeant de design à 360° et en travaillant en collaboration avec de nombreuses entreprises et institutions italiennes et d'autres pays.



1098 LEVICO WALL	P.58
1098B LEVICO WALL S	P.58
1110A LEVICO SMALL	P.182
1110B LEVICO	P.182

EN HENRY & CO. is a Verona design studio founded in 2013 with the belief that sustainability is the only way forward. The aim of HENRY & CO. is to support firms in the design and re-design of both products and communication services, aiming for a circular economy.

IT HENRY & CO. è uno studio di design di Verona nato nel 2013 che progetta con la convinzione che l'unico futuro possibile sia la sostenibilità. Lo scopo di HENRY & CO. è quello di supportare le aziende nella progettazione e ri-progettazione sia di prodotti che di servizi comunicativi puntando ad un'economia circolare.

DE HENRY & CO. ist ein im Jahr 2013 gegründetes Designstudio in Verona, das mit der Überzeugung entwirft, dass Nachhaltigkeit, die einzig mögliche Zukunft ist. Der Zweck von HENRY & CO. ist der, Unternehmen bei der Gestaltung und Neugestaltung von Produkten und kommunikativen Dienstleistungen zu unterstützen, die eine Kreislaufwirtschaft anstreben.

FR HENRY & CO. est un bureau de design de Verona créé en 2013 qui conçoit avec la conviction que le seul futur possible est la durabilité. Le but d'HENRY & CO. est de soutenir les entreprises dans la conception et la refonte de produits comme de services de communication en misant sur une économie circulaire.



1119 PASSO

P.122

EN Industrial designer Luciano Michele Lettieri was born in Venezuela and grew up in Verona. He deepened his knowledge of design at the Verona Fine Arts Academy, from where graduated in industrial design. While at university, Lettieri began collaborating with a number of companies, and shortly after graduating he decided to continue his career path as a freelancer, opening his own design studio. He mainly concentrates on collaborating with manufacturers, companies, and production studios in the B2B and B2C fields, working in particular on the relationship between people and objects, and that emotions and experiences that they generate.

IT Luciano Michele Lettieri è un industrial designer cresciuto nel veronese ma nato in Venezuela. Approfondisce la conoscenza del design presso l'Accademia di Belle Arti di Verona diplomandosi come designer industriale. Durante il percorso universitario inizia a collaborare con alcune realtà e poco dopo la fine degli studi decide di intraprendere la strada della libera professione dando vita al proprio studio di design. Si concentra principalmente nella collaborazione con industrie, aziende e studi di produzione per un pubblico B2B e B2C, lavorando particolarmente sul rapporto tra persone e oggetti, sulle emozioni ed esperienze da esso generate.

DE Luciano Michele Lettieri ist ein in der Provinz Verona aufgewachsener, aber in Venezuela geborener Industrial Designer. Er vertieft seine Kenntnisse im Design an der Kunstakademie in Verona, die er als Industriedesigner abschließt. Während seiner Universitätslaufbahn beginnt er, mit einigen Unternehmen zusammenzuarbeiten, und kurz nach dem Ende des Studiums beschließt er, sich selbstständig zu machen und ein eigenes Designstudio zu eröffnen. Er konzentriert sich vor allem auf die Zusammenarbeit mit Industrien, Formen und Produktionsstudios für ein B2B- und B2C-Publikum, wobei er insbesondere an der Beziehung zwischen Menschen und Objekten, an den Emotionen und Erfahrungen, die sie generieren, arbeitet.

FR Luciano Michele Lettieri est un designer industriel qui a grandi dans la région de Verona mais est né au Venezuela. Il approfondit ses connaissances en matière de design à l'Académie des beaux-arts de Verona, où il obtient un diplôme de designer industriel. Au cours de ses études universitaires, il commence à collaborer avec un certaines entreprises et, peu après la fin de ses études, il décide de se mettre à son compte en créant son propre cabinet de design. Il se concentre principalement sur la collaboration avec des industries, des entreprises et des studios de production pour un public B2B et B2C, en travaillant notamment sur la relation entre les personnes et les objets, sur les émotions et les expériences qu'elle génère.



1114A TOOTH SMALL	P.106
1114B TOOTH	P.106
1112A OOLITE SMOOTH	P.188
1112B OOLITE GRIT	P.188
1112C OOLITE ROUGH	P.188

EN I work as a lighting consultant. I have worked with light for many years, overcoming problems and finding solutions. Because of individual project needs, I often find myself in situations where I need to consider not only the lighting issues but also interior and landscape design. I have found that to achieve the desired result one needs to believe in oneself and in what one does. One needs to work with passion and desire to be able to achieve unimaginable results.

IT Lavoro come consulente per l'illuminazione. Lavoro con la luce da molti anni, superando problemi e trovando soluzioni. A causa delle esigenze di progetto individuali, mi trovo spesso in situazioni in cui devo considerare non solo i problemi di illuminazione, ma anche la progettazione di interni e del paesaggio. Ho scoperto che per ottenere il risultato desiderato bisogna credere in se stessi e in quello che si fa. Bisogna lavorare con passione e voglia per poter raggiungere risultati inimmaginabili.

DE Ich arbeite als Beleuchtungsberater. Seit vielen Jahren arbeite ich mit dem Licht, dabei bewältige ich Probleme und finde Lösungen. Aufgrund der individuellen Projektanforderungen bin ich oft in der Situation, nicht nur die Beleuchtungsprobleme berücksichtigen zu müssen, sondern auch die Innenarchitektur und Landschaftsgestaltung. Ich habe entdeckt, dass man das gewünschte Ergebnis nur erzielt, wenn man an sich und das eigene Schaffen glaubt. Wir müssen mit Leidenschaft und Lust arbeiten, um unvorstellbare Ergebnisse zu erzielen.

FR Je travaille comme consultant en éclairage. Je travaille avec la lumière depuis de nombreuses années, en surmontant les problèmes et en trouvant des solutions. En raison des exigences de chaque projet, je me retrouve souvent dans des situations où je dois prendre en compte non seulement les problèmes d'éclairage, mais aussi l'aménagement intérieur et paysager. J'ai découvert que, pour obtenir le résultat souhaité, il faut croire en soi et en ce que l'on fait. Il faut travailler avec passion et envie pour obtenir des résultats inimaginables.

GENERAL INFORMATION

CONSTANT VOLTAGE POWER SUPPLY ALIMENTAZIONE A TENSIONE COSTANTE LEDSYSTEME MIT KONSTANTSPANNUNGSBETRIEBSGERÄT ALIMENTATION À TENSION CONSTANTE

EN Products marked with (*) require a constant voltage output power supply. Appliances powered at constant voltage must be connected together in parallel as each appliance must be powered at the same voltage [V]. All the items in the 9010novantadeci collection that require a 24Vdc constant voltage power supply are fitted with the customised 9010novantadeci LED circuit.

IT I prodotti con questa (*) indicazione necessitano di un alimentatore con uscita in tensione costante. Il collegamento di più articoli funzionanti in tensione costante deve essere effettuato in parallelo poiché ogni apparecchio deve essere alimentato allo stesso voltaggio [V]. Tutti gli articoli della collezione 9010 che necessitano di un'alimentazione in tensione costante di 24Vdc sono dotati di circuito LED personalizzato 9010.

DE Die Produkte mit der Kennzeichnung (*) benötigen ein Betriebsgerät mit einem Konstantspannungsausgang. Der Anschluss von mehreren mit Konstantspannung betriebenen Artikeln muss parallel erfolgen, weil alle Geräte mit dem gleichen Spannung [V] gespeist werden müssen. Alle Artikel der Kollektion 9010novantadeci, die ein 24Vdc-Konstantspannungsbetriebsgerät benötigen, sind mit dem personalisierten 9010novantadeci-LED-Kreis ausgestattet.

FR Les produits portant l'indication (*) nécessitent une alimentation avec sortie à tension constante. La connexion de plusieurs articles fonctionnant en tension constante doit être effectuée en parallèle puisque chaque appareil doit être alimenté avec le même voltage [V]. Tous les articles de la collection 9010novantadeci qui nécessitent une alimentation avec une tension constante de 24Vdc sont dotés du circuit LED personnalisé 9010novantadeci.

*

C.V.
[V]

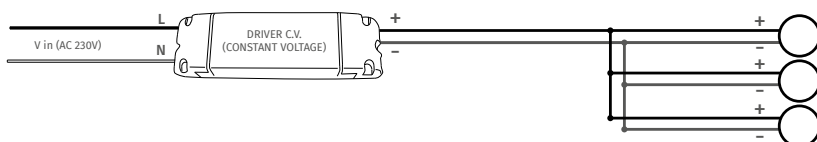

CHOOSING THE POWER SUPPLY

1. The power supply output must be at constant voltage and the output voltage [V] must be equal to the rated output voltage of the powered appliance.
2. The sum of the power outputs [W] of the spotlights to power must not exceed the rated power output of the power supply.

SCELTA DELL'ALIMENTATORE

1. L'uscita dell'alimentatore deve essere a tensione costante (constant voltage) e la tensione in uscita [V] deve essere uguale a quella nominale dell'articolo da pilotare.
2. La somma delle potenze [W] dei faretto da alimentare non deve superare la potenza di targa dell'alimentatore.

WAHL DES BETRIEBSGERÄTS

1. Der Ausgang des Betriebsgeräts muss mit Konstantspannung (constant voltage) sein. Die Ausgangsspannung [V] muss der Nennspannung des zu steuernden Artikels entsprechen.
2. Die Summe der Leistungen [W] der zu speisenden Spots darf die Nennleistung des Betriebsgeräts nicht überschreiten.

CHOIX DE L'ALIMENTATION

1. L'alimentation doit avoir une sortie à tension constante (constant voltage) et la tension de sortie [V] doit être égale à la tension nominale de l'article devant être piloté;
2. La somme des puissances [W] des spots qui doivent être alimentés ne doit pas dépasser la puissance indiquée sur la plaquette de l'alimentation.

EN Dimmer-regulated LED appliances with constant voltage control 9010novantadiecì offers two possibilities of dimming LEDs with constant voltage control:

IT Dimmerazione su articoli LED controllati in tensione costante. 9010 offre due possibilità per la dimmerazione di LED comandati in tensione costante:

DE Ledsysteme mit Konstantspannungsbetriebsgerät 9010novantadiecì bietet zwei Möglichkeiten zum Dimmen von mit Konstantspannung gesteuerten LEDs:

FR Variation sur articles LED contrôlés en tension constante 9010novantadiecì offre deux possibilités pour la variation de LED commandées en tension constante:

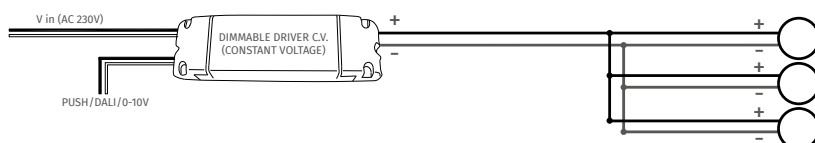

1

WITH DIMMER-REGULATED POWER SUPPLY

This solution is ideal for low power systems (up to a total of 24W); a power supply fitted with a dimmer control feature is used to directly power the LED device.

TRAMITE ALIMENTATORE DIMMERABILE

Questa soluzione è ideale per sistemi di bassa potenza (fino a max 24W totali), per alimentare il dispositivo LED si usa direttamente un alimentatore provvisto della parte di comando per la dimmerazione.

MITTELS DIMMBAREM BETRIEBSGERÄT

Diese Lösung ist ideal für Niedrigleistungssysteme (bis max. 24W insgesamt). Um das LEDGerät zu speisen, verwendet man direkt ein Betriebsgerät, das mit einem Steuerelement zur Dimmung ausgestattet ist.

AVEC ALIMENTATION DIMMABLE

Cette solution est idéale pour les systèmes à basse puissance (jusqu'à 24W max. au total), pour alimenter le dispositif LED on utilise directement une alimentation dotée de la partie de commande pour la variation.

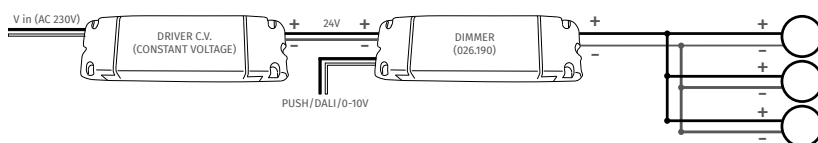

2

WITH DIMMER-REGULATED DRIVER

This solution is ideal for high power systems; to control the device, a driver with signal input used to dim the LED is inserted between the power supply output and the LED.

TRAMITE DRIVER DIMMERABILE

Questa soluzione è ideale per sistemi di potenza elevata, per controllare il dispositivo si interpone tra l'uscita dell'alimentatore ed il LED un driver che prevede l'ingresso del segnale per poter dimmerare il LED.

MITTELS DIMMBAREM TREIBER

Diese Lösung ist ideal für Systeme mit hoher Leistung. Zur Steuerung des Geräts wird zwischen dem Ausgang des Betriebsgeräts und dem LED ein Treiber mit Signaleingang gesetzt, um die LED dimmen zu können.

AVEC DRIVER DIMMABLE

Cette solution est idéale pour les systèmes à puissance élevée, pour contrôler le dispositif on place entre la sortie de l'alimentation et la LED un driver qui prévoit l'entrée du signal pour pouvoir varier la LED.

TYPES OF LIGHT CONTROL SYSTEMS

TIPOLOGIE DI CONTROLLO DELL'ILLUMINAZIONE

STEUERMÖGLICHKEITEN DER BELEUCHTUNG

TYPES DE CONTRÔLE DE L'ÉCLAIRAGE

Power supply with dimmer-regulating button
Alimentatore dimmerabile tramite pulsante
Mittels Taste dimmbares Betriebsgerät
Alimentation dimmable avec bouton poussoir

EN Press the button to switch on the appliance and adjust its light intensity:

- Press and release the button (switch on / off)
 - Press and hold down the button (change light intensity).
- Any control button with a normally open contact can be connected to the power supply.
N.B. The button is not supplied with the power supply.

IT La pressione sul pulsante comanda l'accensione del prodotto e ne regola l'intensità luminosa:
• Pressione breve del pulsante (accensione / spegnimento)
• Pressione prolungata del pulsante (variazione dell'intensità luminosa). Può essere collegato all'alimentatore qualsiasi pulsante di comando con contatto normalmente aperto.
N.B. Il pulsante non è fornito con l'alimentatore.

DE Durch Drücken der Taste wird das Gerät eingeschaltet und die Leuchtstärke geregelt:

- kurzes Drücken der Taste (Einschalten / Ausschalten)
 - langes Drücken der Taste (Variieren der Lichtstärke)
- Hinweis: Die Taste wird nicht mit dem Betriebsgerät geliefert. An das Betriebsgerät kann jede beliebige Steuertaste mit Schließer angeschlossen werden.
N.B. Die Taste ist nicht im Lieferumfang enthalten.

FR La pression du bouton commande l'allumage du produit et règle l'intensité lumineuse:

- Pression brève sur le bouton (allumage/extinction)
- Pression prolongée sur le bouton (variation de l'intensité lumineuse). Tous les boutons de commande avec contact normalement ouvert peuvent être reliés à l'alimentation.
N.B. Le bouton n'est pas fourni avec l'alimentation.

Power supply with dimmer-regulating 0-10V analogue signal
Alimentatore dimmerabile tramite segnale analogico 0-10V
Mittels 0-10V – Analogsignal dimmbares Betriebsgerät
Alimentation dimmable avec signal analogique 0-10V

EN This control typology involves applying an analogue signal to the power supply which can range from 0V (minimum lighting) to 10V (maximum lighting).

IT Questa tipologia di comando consiste nell'applicare all'alimentatore un segnale analogico che può variare dai 0V (illuminazione al minimo) ai 10V (illuminazione massima).

DE Bei dieser Steuerart wird das Betriebsgerät mittels eines Analogsignals gesteuert, das von 0V (Mindestbeleuchtung) bis zu 10V (maximale Beleuchtung) variieren kann.

FR Ce type de commande consiste à appliquer à l'alimentation un signal analogique qui peut aller de 0V (éclairage minimum) à 10V (éclairage maximum).

Power supply with dimmer-regulating DALI system
Alimentatore dimmerabile tramite sistema DALI
Mittels DALI-System Dimmbares Betriebsgerät
Alimentation dimmable avec système DALI

EN The power supply can be powered via a DALI-compatible control unit.

IT L'alimentatore può essere pilotato attraverso un'unità di controllo compatibile con lo standard DALI.

DE Das Betriebsgerät kann mittels einer mit dem DALI-Standard kompatiblen Steuereinheit gesteuert werden.

FR L'alimentation peut être commandée à travers une unité de commande compatible avec le protocole DALI.

Phase cutting dimmable power supply
Alimentatore dimmerabile a taglio di fase
Dimmbares netzgerät mit phasenabschnitt
Alimentation dimmable à coupure de phase

EN Dimming technology already diffused for traditional mains voltage lamps (old incandescent or halogen bulbs). The intensity of the LED light can be varied by acting directly on the primary power supply using an external control device (not supplied with the lamp) with a cut phase output.

IT Tecnologia di dimmerazione già diffusa per le lampade tradizionali a tensione di rete (vecchie incandescenza o alogene). L'intensità della luce del LED può essere variata agendo direttamente sul primario dell'alimentatore tramite l'utilizzo di un dispositivo di comando esterno (non fornito con la lampada) con uscita a fase tagliata.

DE Für herkömmliche Lampen mit Netzspannung (Glüh- und Halogenlampen) bereits verwendete Dimmtechnik. Die Lichtintensität der LED kann durch direktes Einwirken auf den Primärkreis des Netzgeräts unter Verwendung eines externen Steuergeräts (nicht mit der Lampe geliefert) mit Phasenabschnitt am Ausgang geändert werden.

FR Technologie de variation déjà répandue pour les lampes traditionnelles à tension de réseau (vieilles ampoules à incandescence ou halogènes). Il est possible de varier l'intensité de la lumière de la LED directement à travers le primaire de l'alimentation à l'aide d'un dispositif de commande extérieur (non fourni avec la lampe) avec sortie à phase coupée.



Protection degree
 Grado di protezione
 Schutzart
 Niveau de protection



Insulation class
 Classe di isolamento
 Schutzklasse
 Classe d'isolation



Appliance complying with E. E. C. regulation
 Apparecchio conforme alle direttive della Comunità Europea
 Den Richtlinien der Europäischen Gemeinschaft entsprechendes Gerät
 Luminaire conforme aux directives de la Communauté européenne

C.V.
 [V]

Article with constant tension power supply required
 Articolo che necessita alimentatore in tensione costante
 Dieser Artikel erfordert ein Netzgerät, das ständig unter Spannung steht
 Article avec bloc d'alimentation à tension constante requis



Power supply in remote box
 Alimentatore in scatola remota
 Netzgerät in Remotegehäuse
 Bloc d'alimentation dans une boîte à distance

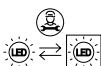

Replaceable light source by a professional
 Sorgente luminosa sostituibile da personale qualificato
 Das Leuchtmittel muss von Fachpersonal ersetzt werden
 Source lumineuse remplaçable par du personnel qualifié

- All 9010novantadiecì products are delivered without bulb, except for products having LED included.
 - The warranty of 9010novantadiecì LED products is not applicable in case of connection with Power Supplies that are not delivered by 9010novantadiecì and/or in case of failure/non conformity with the mounting/connection instructions.
 - Energy Labels are available on demand or downloadable at www.9010.it.
 - Our update catalogues and technical documents are available on demand or downloadable at www.9010.it.
 - Photometric Data are available on demand or downloadable at www.9010.it.
 - All our products comply with CE Directives. Technical evaluations on safety certifications are available on demand.
 - Always contact qualified personnel for the wire connection.
 - Any efflorescence is normal, given the natural characteristics of the product. Efflorescence is a discoloration caused by crystalline salt deposits on concrete surfaces.
 - BETALY® is a handmade material. Aesthetic variations in the colours may occur and does not affect the quality of the product.
 - The brands 9010novantadiecì®, ALUMITE 9010® and BETALY 9010® are registered trademarks of Belfiore Srl.
- Alle Produkte 9010novantadiecì, mit Ausnahme jener inklusive LED, werden mit Lampenfassung aber ohne Lampe geliefert.
 - Die Garantie der Produkte 9010novantadiecì mit LED verfällt, wenn sie nicht mit den für die Artikel 9010novantadiecì gelieferten Betriebsgeräte verwendet bzw. die Anleitungen für den Anschluss missachtet werden.
 - Die Energieetiketten sind auf Anfrage verfügbar oder können von der Webseite www.9010.it heruntergeladen werden.
 - Die aktualisierte Kataloge und technischen Unterlagen sind auf Anfrage verfügbar oder können von der Webseite www.9010.it heruntergeladen werden.
 - Die fotometrischen Daten sind auf Anfrage verfügbar oder können von der Webseite www.9010.it heruntergeladen werden.
 - Alle Produkte entsprechen den EG-Richtlinien. Technische Bewertungen der Sicherheitszertifikate sind auf Anfrage verfügbar. Wenden Sie sich für den Anschluss an qualifiziertes Personal.
 - Aufgrund der natürlichen Eigenschaften des Produkts können Ausblühungen auftreten, die als normale Erscheinung zu betrachten sind. Ausblühungen sind eine Dekolorierung, die durch kristalline Salzablagerungen auf Betonoberflächen entsteht.
 - BETALY® ist ein handverarbeitetes Material. Es können ästhetische Farbabweichungen auftreten, die die Qualität des Produktes nicht beeinflussen.
 - Die Marken 9010novantadiecì®, ALUMITE 9010® und BETALY 9010® sind Eigentum der Belfiore Srl.
- Tutti i prodotti 9010, fatto salvo i prodotti con LED incluso, sono forniti senza lampadina.
 - La garanzia dei prodotti 9010 con LED decade con utilizzo di alimentatori non forniti da 9010 e/o in caso di inosservanza delle istruzioni di collegamento.
 - Le etichette energetiche sono disponibili su richiesta o scaricabili dal sito www.9010.it.
 - I cataloghi e la documentazione tecnica completa e aggiornata sono disponibili su richiesta o scaricabili dal sito www.9010.it.
 - I dati fotometrici sono disponibili su richiesta o scaricabili dal sito www.9010.it.
 - Tutti i prodotti sono conformi alle direttive CE. Valutazioni tecniche sulle certificazioni di sicurezza sono disponibili su richiesta.
 - Rivolgersi a personale qualificato per il collegamento.
 - Eventuali efflorescenze sono normali, dato le caratteristiche naturali del prodotto. Le efflorescenze sono una decolorazione causata da depositi cristallini di sali sulle superfici in calcestruzzo.
 - BETALY® è un materiale realizzato artigianalmente. Pertanto sono possibili variazioni estetiche nei colori, che non pregiudicano la qualità del prodotto.
 - I Marchi 9010®, ALUMITE 9010® e BETALY 9010® sono di proprietà di Belfiore Srl.
- Tous les produits 9010novantadiecì, à l'exception des produits avec LED incluse, sont fournis sans ampoule.
 - La garantie des produits 9010novantadiecì à LED expire en cas d'utilisation d'alimentations non fournies par 9010novantadiecì ou en cas de non-respect des instructions de raccordement.
 - Les étiquettes-énergie sont disponibles sur demande ou peuvent être téléchargées depuis le site www.9010.it.
 - Les catalogues et la documentation technique actualisées sont disponibles sur demande ou peuvent être téléchargés depuis le site www.9010.it.
 - Les données photométriques sont disponibles sur demande ou peuvent être téléchargées depuis le site www.9010.it.
 - Tous les produits sont conformes aux directives CE. Les évaluations techniques sur les certifications de sécurité sont disponibles sur demande.
 - S'adresser à un personnel qualifié pour le raccordement.
 - Comme il s'agit d'un produit naturel, la présence éventuelle d'efflorescences est normale. Les efflorescences sont une décoloration causée par des dépôts de cristaux de sels sur les surfaces en ciment.
 - BETALY® est un matériau réalisé artisanalement. Donc des variations esthétiques dans les couleurs sont possible, qui n'affectent pas la qualité du produit
 - Les marques 9010novantadiecì®, ALUMITE 9010® et BETALY 9010® appartiennent à Belfiore Srl.

BELFIORE SRL
Via Contessa 23
36055, Nove (VI)
Italy

©Belfiore Srl 2022
all rights reserved

Art Direction &
graphic design
Ottone Studio

Photography
Clelia Cadamuro
11-28

Production
Link
113, 118, 197,
213-217, 223-227,
233, 235

Print
Grafiche Antiga spa
October 2022



stampato
con il sole

EN This catalogue must not be wholly or partially reproduced. All rights reserved.
Photographs, descriptions of appliances, technical data, measurements and photometric values given in this catalogue are indicative and do not entail any obligation on our firm, which reserves the right to make any changes it considers appropriate, without prior warning. Technical data given in this catalogue are current at the time of printing (OCTOBER 2022).
Please consult the technical specifications and assembly instruction on our website for updates on technical data. Products included in this catalogue are REGISTERED MODELS.

IT Il presente catalogo non può essere riprodotto neppure parzialmente. Tutti i diritti sono riservati.
Le fotografie, la descrizione degli apparecchi, le quote, le dimensioni ed i valori fotometrici menzionati in questo catalogo sono a titolo indicativo e non costituiscono alcun impegno per la nostra società, che si riserva di apportare, senza preavviso, tutte le modifiche che riterrà opportune. I dati tecnici presenti in questo catalogo sono aggiornati alla data di stampa (OTTOBRE 2022).
Consultare le schede tecniche e le istruzioni di montaggio presenti sul sito web per avere i dati tecnici aggiornati. I prodotti presenti in questo catalogo sono MODELLI REGISTRATI.

DE Der vorliegende Katalog darf weder ganz noch teilweise reproduziert werden. Alle Rechte sind vorbehalten.
Die in diesem Katalog genannten Fotografien, die Beschreibung der Geräte, die Maße, die Abmessungen und photometrischen Werte sind rein indikativ und stellen keine Verpflichtung für unser Unternehmen dar, das sich das Recht vorbehält, alle für angemessen erachtete Änderungen ohne vorherige Ankündigungen vorzunehmen. Die technischen Daten in diesem Katalog wurden zum Zeitpunkt des Drucks (OKTOBER 2022) aktualisiert.
Aktuelle technische Daten finden Sie in den technischen Datenblättern und Montageanleitungen auf der Webseite. Die in diesem Katalog enthaltenen Produkte sind REGISTRIERT.

FR Toute reproduction, en tout ou partie, de ce catalogue est interdite. Tous droits réservés.
Les photographies, la description des appareils, les cotes, les dimensions et les valeurs photométriques indiquées dans ce catalogue sont indicatives et ne sont en aucun cas contraignantes pour notre société, qui se réserve le droit d'apporter, sans préavis, toutes les modifications qu'elle jugera opportunes. Les caractéristiques techniques figurant dans ce catalogue sont à jour à la date d'impression (OCTOBRE 2022).
Consulter les fiches techniques et les instructions de montage disponibles sur le site internet pour obtenir des caractéristiques techniques à jour. Les produits figurant dans ce catalogue sont MODÈLES DÉPOSÉS.

9010.it

